

## Automatic Mode Shift 36 V 300 mA LDO

NO.EA-185-140724

### OUTLINE

The R1510S is a voltage regulator (LDO) IC with a voltage detector (VD) featuring 300mA output current that is developed with CMOS process technology. Each IC is equipped with a voltage detector and a regulator that can provide the maximum 36V of operating voltage. This device has ECO function, which achieves low-power consumption and high-speed transient response by switching the IC to low-power consumption mode at light load condition and switching to high-speed mode at heavy load condition.

The switching point is internally fixed inside the IC. The IC switches from low-power consumption mode to high-speed mode when  $I_{OUT}=12\text{mA}$  (Typ.), and switch from high-speed mode to low-power consumption mode when  $I_{OUT}=3\text{mA}$  (Typ.).

Each IC is composed of a reference voltage unit, an error amplifier, a resistor network for setting output voltage, an output current limit circuit for preventing overcurrent destruction, and a thermal shutdown circuit. The output voltage and the detector threshold are internally fixed inside the IC.

The output voltage accuracy is  $\pm 1.6\%$  and the detector threshold accuracy is  $\pm 1.7\%$ . The output voltage type is Nch open drain. The versions for the IC are selectable from A version (CE,  $V_{IN}$  Detector), B version (SENSE Detector), C version (Release Delay Circuit,  $V_{IN}$  Detector), and D version (Release Delay Circuit,  $V_{OUT}$  Detector).

### FEATURES

- Input Voltage Range (Maximum Rating) ..... Max. 36.0V (50V)
- Operating Temperature Range ..... -40°C to 105°C
- Supply Current ..... Typ. 110 $\mu\text{A}$  (High Speed Mode,  $V_{IN}=14\text{V}$ )
- Supply Current ..... Typ. 12.5 $\mu\text{A}$  (Low-power Consumption Mode,  $V_{IN}=14\text{V}$ )
- Supply Current (Standby Mode) ..... Typ. 10 $\mu\text{A}$  (CE=0V, A Version)
- Output Voltage Range ..... 2.5V to 12.0V (0.1V step)
- Dropout Voltage ..... Typ. 1.0V ( $I_{OUT}=300\text{mA}$ ,  $V_{OUT}=5\text{V}$ )
- Output Voltage Accuracy .....  $\pm 1.6\%$  ( $T_a=25^\circ\text{C}$ )
- Temperature Characteristics ..... Typ.  $\pm 150\text{ppm}/^\circ\text{C}$  (Output Voltage)
- Detector Threshold ..... 2.3V to 12.0V (0.1V steps)
- Detector Threshold Accuracy .....  $\pm 1.7\%$  ( $T_a=25^\circ\text{C}$ )
- Temperature Characteristics ..... Typ.  $\pm 100\text{ppm}/^\circ\text{C}$  (Detector Threshold)
- Output Type ..... Nch Open Drain
- Line Regulation ..... Typ. 0.01%/V
- Package ..... HSOP-8E
- Built-in Short Current Limit Circuit ..... Typ. 50mA
- Built-in Overcurrent Protection Circuit
- Built-in Thermal Shutdown Circuit ..... Shutdown Temperature: Typ. 140°C,  
Release Temperature: Typ. 125°C
- Ceramic Capacitor Corresponding ..... 6.8 $\mu\text{F}$  or more

# R1510S

NO.EA-185-140724

## APPLICATIONS

- Power source for notebook PCs, digital TVs, telephones, private LAN systems, etc.
- Power source for office equipments such as copiers, printers, facsimiles, scanners, and projectors

## BLOCK DIAGRAMS

**R1510SxxxA**  
(CE Pin,  $V_{IN}$  Detector)

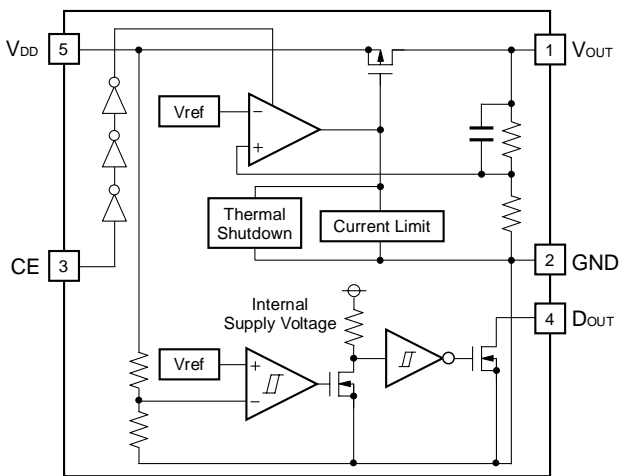

**R1510SxxxB**  
(SENSE Detector)

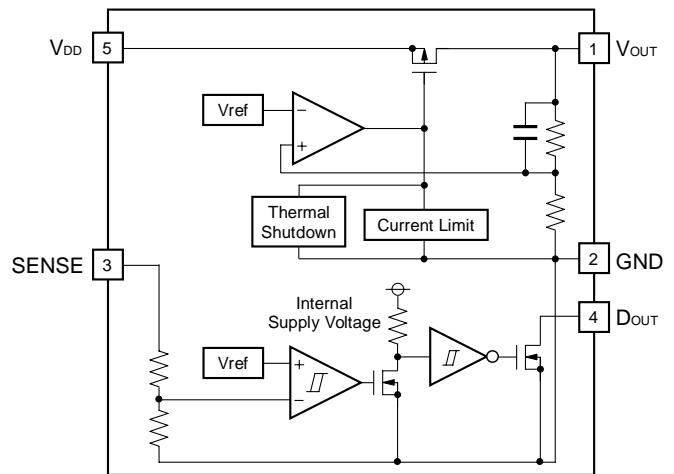

**R1510SxxxC**  
( $C_D$  Pin,  $V_{IN}$  Detector)

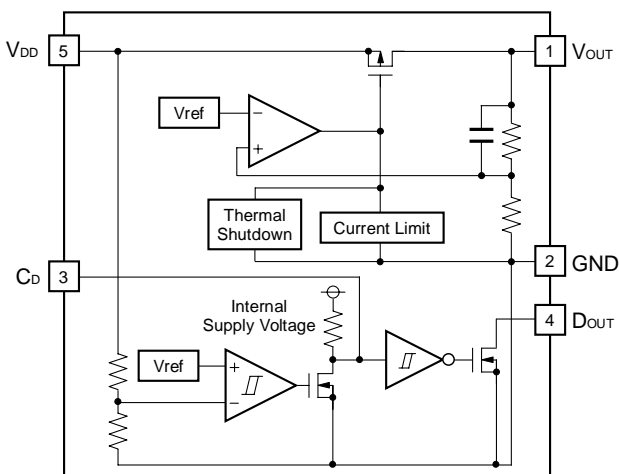

**R1510SxxxD**  
( $C_D$  Pin,  $V_{OUT}$  Detector)

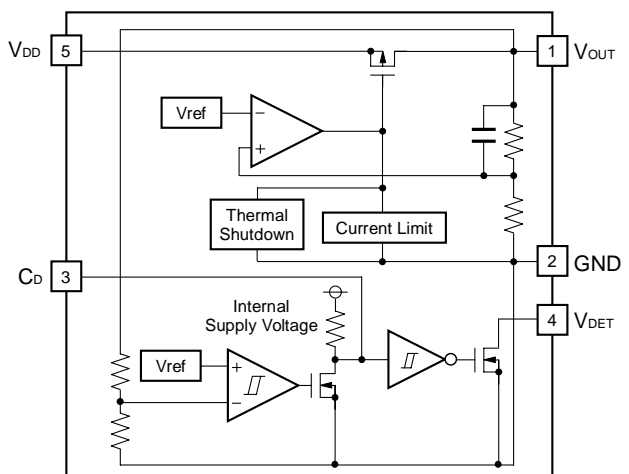

## SELECTION GUIDE

The users can select VR output voltage, VD detector threshold, and version that best fit their requirements.

Product Name	Package	Quantity per Reel	Pb Free	Halogen Free
R1510Sxxx*-E2-FE	HSOP-8E	1,000 pcs	Yes	Yes
xxx: Select the ideal combination of the output voltage ( $V_{OUT}$ ) and the detector threshold ( $-V_{DET}$ ) from the code number starting from 001. Refer to <i>MARK SPECIFICATION TABLE</i> for detailed information.				
*: Select the ideal version from A to D. (A) Built-in Chip Enable, $V_{IN}$ Detector (B) SENSE Detector Threshold (C) Built-in Release Delay Circuit, $V_{IN}$ Detector (D) Built-in Release Delay Circuit, $V_{OUT}$ Detector				

## PIN DESCRIPTIONS

### • HSOP-8E

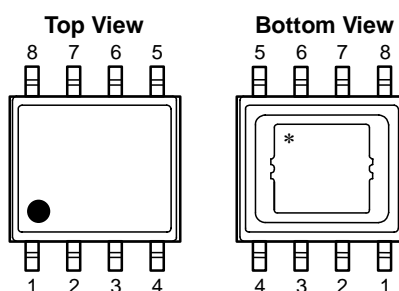

Pin No.	Symbol	Description
1	$V_{OUT}$	VR Output Pin
2	NC	No Connection
3	TP*3	Test Pin
4	$D_{OUT}$	VD Output Pin (Nch Open Drain)
5	CE	A Version: Chip Enable Pin ("H" Active)
	SENSE*1	B Version: VD Sense Pin
	$C_D$ *2	C, D Versions: Release Output Delay (Power-on Reset) Time Setting Pin
6	TP*3	Test Pin
7	GND	Ground Pin
8	$V_{DD}$	Input Pin

\* ) The tab on the reverse side of the IC is in GND level and it should be connected to GND pin (recommended) or should be left open.

\*1) B version monitors SENSE pin voltage.

\*2) The release output delay time of voltage detector can be set by connecting a capacitor to CD pin.

\*3) TP pin should be connected to GND.

**R1510S**

NO.EA-185-140724

**ABSOLUTE MAXIMUM RATINGS**

Symbol	Item	Rating	Unit
$V_{IN}$	Input Voltage	-0.3 to 50	V
$V_{CE}$	Input Voltage (CE Pin, A Version)	-0.3 to 7.0	V
$V_{SENSE}$	Input Voltage (SENSE Pin, B Version)	-0.3 to 50	V
$V_{CD}$	Input Voltage (C <sub>D</sub> Pin, C or D Version)	-0.3 to 7.0	V
$V_{OUT}$	Output Voltage (VR)	-0.3 to $V_{IN}+0.3 \leq 50$	V
$V_{RESET}$	Output Voltage (VD)	-0.3 to 7.0	V
$I_{OUT1}$	Output Current (VR)	450	mA
$I_{OUT2}$	Output Current (VD)	20	mA
$P_D$	Power Dissipation (HSOP-8E)* Ultra High Wattage Land Pattern	2900	mW
$T_a$	Operating Temperature Range	-40 to 105	°C
$T_{stg}$	Storage Temperature Range	-55 to 125	°C

\*) Refer to *PACKAGE INFORMATION* for detailed information.

**ABSOLUTE MAXIMUM RATINGS**

Electronic and mechanical stress momentarily exceeded absolute maximum ratings may cause the permanent damages and may degrade the lifetime and safety for both device and system using the device in the field. The functional operation at or over these absolute maximum ratings is not assured.

## ELECTRICAL CHARACTERISTICS

### R1510SxxxA Series

$V_{IN}=14.0V$ ,  $C_E=5.0V$ ,  $C_{OUT}=6.8\mu F$ ,  $R_{pull-up}=100k\Omega$ ,  $V_{pull-up}=5.0V$ , unless otherwise noted.

The specifications surrounded by   are guaranteed by design engineering at  $-40^{\circ}C \leq T_a \leq 105^{\circ}C$ .

For all

( $T_a=25^{\circ}C$ )

Symbol	Item	Conditions	Min.	Typ.	Max.	Unit
$V_{IN}$	Input Voltage		<span style="border: 1px solid black; padding: 0 2px;">3.5</span>		<span style="border: 1px solid black; padding: 0 2px;">36</span>	V
$I_{SS1}$	Supply Current (Low-power Consumption Mode)	$I_{OUT}=0A$		12.5	<span style="border: 1px solid black; padding: 0 2px;">27</span>	$\mu A$
$I_{SS2}$	Supply Current (High Speed Mode)	$I_{OUT}=20mA$		110	<span style="border: 1px solid black; padding: 0 2px;">174</span>	$\mu A$
$I_{standby}$	Standby Current (Standby Mode)	$C_E=0V$		10	<span style="border: 1px solid black; padding: 0 2px;">23</span>	$\mu A$
$T_{TSD}$	Thermal Shutdown Temperature	Junction Temperature		140		$^{\circ}C$
$T_{TSR}$	Thermal Shutdown Released Temperature	Junction Temperature		125		$^{\circ}C$

VR

( $T_a=25^{\circ}C$ )

Symbol	Item	Conditions		Min.	Typ.	Max.	Unit
$V_{OUT}$	Output Voltage	$I_{OUT}=1mA$ Setting Voltage: 2.5V to 12.0V	$T_a=25^{\circ}C$ $-40^{\circ}C \leq T_a \leq 105^{\circ}C$	$\times 0.984$ <span style="border: 1px solid black; padding: 0 2px;"><math>\times 0.964</math></span>		$\times 1.016$ <span style="border: 1px solid black; padding: 0 2px;"><math>\times 1.045</math></span>	V
$I_{OUT1}$	Output Current	$V_{IN}=V_{OUT}+3.2V$ ( $V_{OUT} < 5.0V$ ) $V_{IN}=V_{OUT}+2.0V$ ( $V_{OUT} \geq 5.0V$ )		<span style="border: 1px solid black; padding: 0 2px;">300</span>			mA
$\Delta V_{OUT}/\Delta I_{OUT}$	Load Regulation	$V_{IN}=V_{OUT}+3.2V$ ( $V_{OUT} < 5.0V$ ) $V_{IN}=V_{OUT}+2.0V$ ( $V_{OUT} \geq 5.0V$ )					mV
		$0.1mA \leq I_{OUT} \leq 7mA$ (Low-power Consumption Mode)	$V_{OUT} \leq 5.0V$		7	<span style="border: 1px solid black; padding: 0 2px;">13</span>	
			$V_{OUT} > 5.0V$		10	<span style="border: 1px solid black; padding: 0 2px;">20</span>	
		$0.1mA \leq I_{OUT} \leq 20mA$	$V_{OUT} \leq 5.0V$		10	<span style="border: 1px solid black; padding: 0 2px;">45</span>	
			$V_{OUT} > 5.0V$		20	<span style="border: 1px solid black; padding: 0 2px;">75</span>	
		$0.1mA \leq I_{OUT} \leq 300mA$	$V_{OUT} \leq 5.0V$		40	<span style="border: 1px solid black; padding: 0 2px;">100</span>	
$V_{OUT} > 5.0V$			60	<span style="border: 1px solid black; padding: 0 2px;">170</span>			
$V_{DIF}$	Dropout Voltage	$I_{OUT}=7mA$ (Low-power Consumption Mode)	$V_{OUT} < 5.0V$		0.5	<span style="border: 1px solid black; padding: 0 2px;">1.8</span>	V
			$V_{OUT} \geq 5.0V$		0.3	<span style="border: 1px solid black; padding: 0 2px;">0.95</span>	
		$I_{OUT}=300mA$	$V_{OUT} < 5.0V$		1.5	<span style="border: 1px solid black; padding: 0 2px;">3.2</span>	
			$V_{OUT} \geq 5.0V$		1.0	<span style="border: 1px solid black; padding: 0 2px;">2.0</span>	
$I_{OUTH}$	High Speed Mode Switching Current	$I_{OUT}=\text{Light Load to Heavy Load}$		<span style="border: 1px solid black; padding: 0 2px;">8.5</span>	12	<span style="border: 1px solid black; padding: 0 2px;">16.3</span>	mA
$I_{OUTL}$	Low-power Consumption Mode Switching Current	$I_{OUT}=\text{Heavy Load to Light Load}$		<span style="border: 1px solid black; padding: 0 2px;">1</span>	3	<span style="border: 1px solid black; padding: 0 2px;">5</span>	mA
$\Delta V_{OUT}/\Delta V_{IN}$	Line Regulation	$3.5V \leq V_{IN} \leq 36V$ ( $2.5V \leq V_{OUT} \leq 3.5V$ ) $V_{OUT}+0.5V \leq V_{IN} \leq 36V$ ( $V_{OUT} > 3.5V$ ) $I_{OUT}=1mA$			0.01	<span style="border: 1px solid black; padding: 0 2px;">0.05</span>	%/V
$\Delta V_{OUT}/\Delta T_a$	Output Voltage Temperature Coefficient	$-40^{\circ}C \leq T_a \leq 105^{\circ}C$			$\pm 150$		ppm/ $^{\circ}C$

**R1510S**

NO.EA-185-140724

$V_{IN}=14.0V$ ,  $C_E=5.0V$ ,  $C_{OUT}=6.8\mu F$ ,  $R_{pull-up}=100k\Omega$ ,  $V_{pull-up}=5.0V$ , unless otherwise noted.

The specifications surrounded by   are guaranteed by design engineering at  $-40^{\circ}C \leq T_a \leq 105^{\circ}C$ .

**VR (Continued)**

(Ta=25°C)

Symbol	Item	Conditions	Min.	Typ.	Max.	Unit
$I_{SC}$	Short Current Limit	$V_{OUT}=0V$		50		mA
$V_{CEH}$	CE Input Voltage "H"		<span style="border: 1px solid black; padding: 0 2px;">1.5</span>		<span style="border: 1px solid black; padding: 0 2px;">5.5</span>	V
$V_{CEL}$	CE Input Voltage "L"				<span style="border: 1px solid black; padding: 0 2px;">0.7</span>	V

**VD**

(Ta=25°C)

Symbol	Item	Conditions	Min.	Typ.	Max.	Unit	
$-V_{DET}$	Detector Threshold	$V_{IN}$ Detector Setting Voltage Range: 2.3 V to 12.0V	$T_a=25^{\circ}C$	$\times 0.983$		$\times 1.017$	V
			$-40^{\circ}C \leq T_a \leq 105^{\circ}C$	<span style="border: 1px solid black; padding: 0 2px;"><math>\times 0.97</math></span>		<span style="border: 1px solid black; padding: 0 2px;"><math>\times 1.03</math></span>	
$V_{HYS}$	Detector Threshold Hysteresis		$-V_{DET}$ <span style="border: 1px solid black; padding: 0 2px;"><math>\times 0.025</math></span>	$-V_{DET}$ $\times 0.05$	$-V_{DET}$ <span style="border: 1px solid black; padding: 0 2px;"><math>\times 0.075</math></span>	V	
$V_{DDL}$	Minimum Operating Voltage*1				<span style="border: 1px solid black; padding: 0 2px;">1.8</span>	V	
$I_{OUT2}$	Output Current (Nch Driver)	$V_{IN} \geq 1.8V$ , $D_{OUT}=0.1V$		<span style="border: 1px solid black; padding: 0 2px;">0.59</span>		mA	
		$V_{IN} \geq 3.0V$ , $D_{OUT}=0.1V$		<span style="border: 1px solid black; padding: 0 2px;">1.16</span>			
		$V_{IN} \geq 4.0V$ , $D_{OUT}=0.1V$		<span style="border: 1px solid black; padding: 0 2px;">1.39</span>			
$I_{LEAK}$	Nch Driver Leakage Current	$D_{OUT}=7V$			<span style="border: 1px solid black; padding: 0 2px;">0.33</span>	$\mu A$	
$V_{RESET}$	Pull-up Voltage				<span style="border: 1px solid black; padding: 0 2px;">5.5</span>	V	
$\Delta V_{DET}/\Delta T_a$	Detector Threshold Temperature Coefficient	$-40^{\circ}C \leq T_a \leq 105^{\circ}C$		$\pm 100$		ppm/ $^{\circ}C$	
$t_{PLH}$	Release Output Delay Time*2			<span style="border: 1px solid black; padding: 0 2px;">20</span>		$\mu s$	

All test items listed under Electrical Characteristics are done under the pulse load condition ( $T_j \approx T_a = 25^{\circ}C$ ) except Output Voltage Temperature Coefficient and Detector Threshold Temperature Coefficient.

\*1) Minimum operating voltage is defined as the power supply voltage of which output voltage becomes lower than 0.1V at the detection.

\*2) Release output delay time is defined as the time to be taken for  $V_{IN}$  to change from 2V to  $(-V_{DET}) + 1V$ , and for  $D_{OUT}$  output to become "H".

**RECOMMENDED OPERATING CONDITIONS (ELECTRICAL CHARACTERISTICS)**

All of electronic equipment should be designed that the mounted semiconductor devices operate within the recommended operating conditions. The semiconductor devices cannot operate normally over the recommended operating conditions, even if when they are used over such conditions by momentary electronic noise or surge. And the semiconductor devices may receive serious damage when they continue to operate over the recommended operating conditions.

**R1510SxxxB Series**

$V_{IN}=SENSE=14.0V$ ,  $C_{OUT}=6.8\mu F$ ,  $R_{pull-up}=100k\Omega$ ,  $V_{pull-up}=5.0V$ , unless otherwise noted.

The specifications surrounded by   are guaranteed by design engineering at  $-40^{\circ}C \leq T_a \leq 105^{\circ}C$ .

**For all**

(Ta=25°C)

Symbol	Item	Conditions	Min.	Typ.	Max.	Unit
$V_{IN}$	Input Voltage		<span style="border: 1px solid black; padding: 0 2px;">3.5</span>		<span style="border: 1px solid black; padding: 0 2px;">36</span>	V
$I_{SS1}$	Supply Current (Low-power Consumption Mode)	$I_{OUT}=0A$		12.5	<span style="border: 1px solid black; padding: 0 2px;">22</span>	$\mu A$
$I_{SS2}$	Supply Current (High Speed Mode)	$I_{OUT}=20mA$		110	<span style="border: 1px solid black; padding: 0 2px;">174</span>	$\mu A$
$T_{TSD}$	Thermal Shutdown Temperature	Junction Temperature		140		$^{\circ}C$
$T_{TSR}$	Thermal Shutdown Released Temperature	Junction Temperature		125		$^{\circ}C$

**VR**

(Ta=25°C)

Symbol	Item	Conditions	Min.	Typ.	Max.	Unit	
$V_{OUT}$	Output Voltage	$I_{OUT}=1mA$ Setting Voltage: 2.5V to 12.0V	$\times 0.984$		$\times 1.016$	V	
		$-40^{\circ}C \leq T_a \leq 105^{\circ}C$	<span style="border: 1px solid black; padding: 0 2px;"><math>\times 0.964</math></span>		<span style="border: 1px solid black; padding: 0 2px;"><math>\times 1.045</math></span>		
$I_{OUT1}$	Output Current	$V_{IN}=V_{OUT}+3.2V$ ( $V_{OUT} < 5.0V$ ) $V_{IN}=V_{OUT}+2.0V$ ( $V_{OUT} \geq 5.0V$ )	<span style="border: 1px solid black; padding: 0 2px;">300</span>			mA	
$\Delta V_{OUT}/\Delta I_{OUT}$	Load Regulation	$V_{IN}=V_{OUT}+3.2V$ ( $V_{OUT} < 5.0V$ ) $V_{IN}=V_{OUT}+2.0V$ ( $V_{OUT} \geq 5.0V$ )				mV	
		$0.1mA \leq I_{OUT} \leq 7mA$ (Low-power Consumption Mode)	$V_{OUT} \leq 5.0V$		7		<span style="border: 1px solid black; padding: 0 2px;">13</span>
			$V_{OUT} > 5.0V$		10		<span style="border: 1px solid black; padding: 0 2px;">20</span>
		$0.1mA \leq I_{OUT} \leq 20mA$	$V_{OUT} \leq 5.0V$		10		<span style="border: 1px solid black; padding: 0 2px;">45</span>
			$V_{OUT} > 5.0V$		20		<span style="border: 1px solid black; padding: 0 2px;">75</span>
	$0.1mA \leq I_{OUT} \leq 300mA$	$V_{OUT} \leq 5.0V$		40	<span style="border: 1px solid black; padding: 0 2px;">100</span>		
		$V_{OUT} > 5.0V$		60	<span style="border: 1px solid black; padding: 0 2px;">170</span>		
$V_{DIF}$	Dropout Voltage	$I_{OUT}=7mA$ (Low-power Consumption Mode)	$V_{OUT} < 5.0V$	0.5	<span style="border: 1px solid black; padding: 0 2px;">1.8</span>	V	
			$V_{OUT} \geq 5.0V$	0.3	<span style="border: 1px solid black; padding: 0 2px;">0.95</span>		
		$I_{OUT}=300mA$	$V_{OUT} < 5.0V$	1.5	<span style="border: 1px solid black; padding: 0 2px;">3.2</span>		
			$V_{OUT} \geq 5.0V$	1.0	<span style="border: 1px solid black; padding: 0 2px;">2.0</span>		
$I_{OUTH}$	High Speed Mode Switching Current	$I_{OUT} = \text{Light Load to Heavy Load}$	<span style="border: 1px solid black; padding: 0 2px;">8.5</span>	12	<span style="border: 1px solid black; padding: 0 2px;">16.3</span>	mA	
$I_{OUTL}$	Low-power Consumption Mode Switching Current	$I_{OUT} = \text{Heavy Load to Light Load}$	<span style="border: 1px solid black; padding: 0 2px;">1</span>	3	<span style="border: 1px solid black; padding: 0 2px;">5</span>	mA	
$\Delta V_{OUT}/\Delta V_{IN}$	Line Regulation	$3.5V \leq V_{IN} \leq 36V$ ( $2.5V \leq V_{OUT} \leq 3.5V$ ) $V_{OUT}+0.5V \leq V_{IN} \leq 36V$ ( $V_{OUT} > 3.5V$ ) $I_{OUT}=1mA$		0.01	<span style="border: 1px solid black; padding: 0 2px;">0.05</span>	%/V	
$\Delta V_{OUT}/\Delta T_a$	Output Voltage Temperature Coefficient	$-40^{\circ}C \leq T_a \leq 105^{\circ}C$		$\pm 150$		ppm/ $^{\circ}C$	
$I_{SC}$	Short Current Limit	$V_{OUT}=0V$		50		mA	

**R1510S**

NO.EA-185-140724

$V_{IN}=SENSE=14.0V$ ,  $C_{OUT}=6.8\mu F$ ,  $R_{pull-up}=100k\Omega$ ,  $V_{pull-up}=5.0V$ , unless otherwise noted.

The specifications surrounded by   are guaranteed by design engineering at  $-40^{\circ}C \leq T_a \leq 105^{\circ}C$ .

**VD** (Ta=25°C)

Symbol	Item	Conditions	Min.	Typ.	Max.	Unit	
$-V_{DET}$	Detector Threshold	$V_{IN}$ Detector Setting Voltage: 2.3 V to 12.0V	$T_a=25^{\circ}C$	$\times 0.983$		$\times 1.017$	V
			$-40^{\circ}C \leq T_a \leq 105^{\circ}C$	<span style="border: 1px solid black; padding: 0 2px;">×0.97</span>		<span style="border: 1px solid black; padding: 0 2px;">×1.03</span>	
$V_{HYS}$	Detector Threshold Hysteresis		$-V_{DET}$ <span style="border: 1px solid black; padding: 0 2px;">×0.025</span>	$-V_{DET}$ $\times 0.05$	$-V_{DET}$ <span style="border: 1px solid black; padding: 0 2px;">×0.075</span>	V	
$R_{SENSE}$	SENSE Resistance	$-V_{DET} < 6.0V$	<span style="border: 1px solid black; padding: 0 2px;">1.5</span>		<span style="border: 1px solid black; padding: 0 2px;">64</span>	$M\Omega$	
		$-V_{DET} \geq 6.0V$	<span style="border: 1px solid black; padding: 0 2px;">3.6</span>		<span style="border: 1px solid black; padding: 0 2px;">57</span>		
$V_{DDL}$	Minimum Operating Voltage				<span style="border: 1px solid black; padding: 0 2px;">3.0</span>	V	
$I_{OUT2}$	Output Current (Nch Driver)	$V_{IN} \geq 3.0V$ , $D_{OUT}=0.1V$	<span style="border: 1px solid black; padding: 0 2px;">1.16</span>			mA	
		$V_{IN} \geq 4.0V$ , $D_{OUT}=0.1V$	<span style="border: 1px solid black; padding: 0 2px;">1.39</span>				
$I_{LEAK}$	Nch Driver Leakage Current	$D_{OUT}=7V$			<span style="border: 1px solid black; padding: 0 2px;">0.33</span>	$\mu A$	
$V_{RESET}$	Pull-up Voltage				<span style="border: 1px solid black; padding: 0 2px;">5.5</span>	V	
$\Delta-V_{DET}/\Delta T_a$	Detector Threshold Temperature Coefficient	$-40^{\circ}C \leq T_a \leq 105^{\circ}C$		$\pm 100$		ppm/ $^{\circ}C$	
$t_{PLH}$	Release Output Delay Time *1			<span style="border: 1px solid black; padding: 0 2px;">20</span>		$\mu s$	
$V_{SENSE}$	SENSE Pin Input Voltage				<span style="border: 1px solid black; padding: 0 2px;">36</span>	V	

All test items listed under Electrical Characteristics are done under the pulse load condition ( $T_j \approx T_a = 25^{\circ}C$ ) except Output Voltage Temperature Coefficient and Detector Threshold Temperature Coefficient.

\*1) Release output delay time is defined as the time to be taken for SENSE to change from 2V to  $(-V_{DET}) + 1V$ , and for  $D_{OUT}$  output to become "H".

**RECOMMENDED OPERATING CONDITIONS (ELECTRICAL CHARACTERISTICS)**

All of electronic equipment should be designed that the mounted semiconductor devices operate within the recommended operating conditions. The semiconductor devices cannot operate normally over the recommended operating conditions, even if when they are used over such conditions by momentary electronic noise or surge. And the semiconductor devices may receive serious damage when they continue to operate over the recommended operating conditions.



## R1510SxxxC Series

$V_{IN}=14.0V$ ,  $C_{OUT}=6.8\mu F$ ,  $C_D=0.01\mu F$ ,  $R_{pull-up}=100k\Omega$ ,  $V_{pull-up}=5.0V$ , unless otherwise noted.

The specifications surrounded by   are guaranteed by design engineering at  $-40^{\circ}C \leq T_a \leq 105^{\circ}C$ .

For all

(Ta=25°C)

Symbol	Item	Conditions	Min.	Typ.	Max.	Unit
$V_{IN}$	Input Voltage		<span style="border: 1px solid black; padding: 0 2px;">3.5</span>		<span style="border: 1px solid black; padding: 0 2px;">36</span>	V
$I_{SS1}$	Supply Current (Low-power Consumption Mode)	$I_{OUT}=0A$		12.5	<span style="border: 1px solid black; padding: 0 2px;">27</span>	$\mu A$
$I_{SS2}$	Supply Current (High Speed Mode)	$I_{OUT}=20mA$		110	<span style="border: 1px solid black; padding: 0 2px;">174</span>	$\mu A$
$T_{TSD}$	Thermal Shutdown Temperature	Junction Temperature		140		$^{\circ}C$
$T_{TSR}$	Thermal Shutdown Released Temperature	Junction Temperature		125		$^{\circ}C$

VR

(Ta=25°C)

Symbol	Item	Conditions	Min.	Typ.	Max.	Unit	
$V_{OUT}$	Output Voltage	$I_{OUT}=1mA$ Setting Voltage: 2.5V to 12.0V	$T_a=25^{\circ}C$	$\times 0.984$		$\times 1.016$	V
			$-40^{\circ}C \leq T_a \leq 105^{\circ}C$	<span style="border: 1px solid black; padding: 0 2px;"><math>\times 0.964</math></span>		<span style="border: 1px solid black; padding: 0 2px;"><math>\times 1.045</math></span>	
$I_{OUT1}$	Output Current	$V_{IN}=V_{OUT}+3.2V$ ( $V_{OUT} < 5.0V$ ) $V_{IN}=V_{OUT}+2.0V$ ( $V_{OUT} \geq 5.0V$ )		<span style="border: 1px solid black; padding: 0 2px;">300</span>		mA	
$\Delta V_{OUT}/\Delta I_{OUT}$	Load Regulation	$V_{IN}=V_{OUT}+3.2V$ ( $V_{OUT} < 5.0V$ ) $V_{IN}=V_{OUT}+2.0V$ ( $V_{OUT} \geq 5.0V$ )				mV	
		$0.1mA \leq I_{OUT} \leq 7mA$ (Low-power Consumption Mode)	$V_{OUT} \leq 5.0V$		7		<span style="border: 1px solid black; padding: 0 2px;">13</span>
			$V_{OUT} > 5.0V$		10		<span style="border: 1px solid black; padding: 0 2px;">20</span>
		$0.1mA \leq I_{OUT} \leq 20mA$	$V_{OUT} \leq 5.0V$		10		<span style="border: 1px solid black; padding: 0 2px;">45</span>
			$V_{OUT} > 5.0V$		20		<span style="border: 1px solid black; padding: 0 2px;">75</span>
		$0.1mA \leq I_{OUT} \leq 300mA$	$V_{OUT} \leq 5.0V$		40		<span style="border: 1px solid black; padding: 0 2px;">100</span>
$V_{OUT} > 5.0V$			60	<span style="border: 1px solid black; padding: 0 2px;">170</span>			
$V_{DIF}$	Dropout Voltage	$I_{OUT}=7mA$ (Low-power Consumption Mode)	$V_{OUT} < 5.0V$		0.5	<span style="border: 1px solid black; padding: 0 2px;">1.8</span>	V
			$V_{OUT} \geq 5.0V$		0.3	<span style="border: 1px solid black; padding: 0 2px;">0.95</span>	
		$I_{OUT}=300mA$	$V_{OUT} < 5.0V$		1.5	<span style="border: 1px solid black; padding: 0 2px;">3.2</span>	
			$V_{OUT} \geq 5.0V$		1.0	<span style="border: 1px solid black; padding: 0 2px;">2.0</span>	
$I_{OUTH}$	High Speed Mode Switching Current	$I_{OUT}$ =Light Load to Heavy Load		<span style="border: 1px solid black; padding: 0 2px;">8.5</span>	12	<span style="border: 1px solid black; padding: 0 2px;">16.3</span>	mA
$I_{OUTL}$	Low-power Consumption Mode Switching Current	$I_{OUT}$ =Heavy Load to Light Load		<span style="border: 1px solid black; padding: 0 2px;">1</span>	3	<span style="border: 1px solid black; padding: 0 2px;">5</span>	mA
$\Delta V_{OUT}/\Delta V_{IN}$	Line Regulation	$3.5V \leq V_{IN} \leq 36V$ ( $2.5V \leq V_{OUT} \leq 3.5V$ ) $V_{OUT}+0.5V \leq V_{IN} \leq 36V$ ( $V_{OUT} > 3.5V$ ) $I_{OUT}=1mA$		0.01	<span style="border: 1px solid black; padding: 0 2px;">0.05</span>	%/V	
$\Delta V_{OUT}/\Delta T_a$	Output Voltage Temperature Coefficient	$-40^{\circ}C \leq T_a \leq 105^{\circ}C$		$\pm 150$		ppm/ $^{\circ}C$	
$I_{SC}$	Short Current Limit	$V_{OUT}=0V$		50		mA	

**R1510S**

NO.EA-185-140724

 $V_{IN}=14.0V$ ,  $C_{OUT}=6.8\mu F$ ,  $C_D=0.01\mu F$ ,  $R_{pull-up}=100k\Omega$ ,  $V_{pull-up}=5.0V$ , unless otherwise noted.The specifications surrounded by   are guaranteed by design engineering at  $-40^{\circ}C \leq T_a \leq 105^{\circ}C$ .**VD**

(Ta=25°C)

Symbol	Item	Conditions	Min.	Typ.	Max.	Unit	
$-V_{DET}$	Detector Threshold	$V_{IN}$ Detector Setting Voltage: 2.3 V to 12.0V	$T_a=25^{\circ}C$	$\times 0.983$		$\times 1.017$	V
			$-40^{\circ}C \leq T_a \leq 105^{\circ}C$	<span style="border: 1px solid black; padding: 0 2px;">0.97</span>		<span style="border: 1px solid black; padding: 0 2px;">1.03</span>	
$V_{HYS}$	Detector Threshold Hysteresis		$-V_{DET}$ <span style="border: 1px solid black; padding: 0 2px;">0.025</span>	$-V_{DET}$ $\times 0.05$	$-V_{DET}$ <span style="border: 1px solid black; padding: 0 2px;">0.075</span>	V	
$V_{DDL}$	Minimum Operating Voltage *1				<span style="border: 1px solid black; padding: 0 2px;">1.8</span>	V	
$I_{OUT2}$	Output Current (Nch Driver)	$V_{IN} \geq 1.8V$ , $D_{OUT}=0.1V$		<span style="border: 1px solid black; padding: 0 2px;">0.59</span>			mA
		$V_{IN} \geq 3.0V$ , $D_{OUT}=0.1V$		<span style="border: 1px solid black; padding: 0 2px;">1.16</span>			
		$V_{IN} \geq 4.0V$ , $D_{OUT}=0.1V$		<span style="border: 1px solid black; padding: 0 2px;">1.39</span>			
$I_{LEAK}$	Nch Driver Leakage Current	$D_{OUT}=7V$			<span style="border: 1px solid black; padding: 0 2px;">0.33</span>	$\mu A$	
$V_{RESET}$	Pull-up Voltage				<span style="border: 1px solid black; padding: 0 2px;">5.5</span>	V	
$\Delta V_{DET}/\Delta T_a$	Detector Threshold Temperature Coefficient	$-40^{\circ}C \leq T_a \leq 105^{\circ}C$		$\pm 100$		ppm/ $^{\circ}C$	
$t_{delay}$	Release Output Delay Time*2		<span style="border: 1px solid black; padding: 0 2px;">35</span>	70	<span style="border: 1px solid black; padding: 0 2px;">150</span>	ms	

All test items listed under Electrical Characteristics are done under the pulse load condition ( $T_j \approx T_a = 25^{\circ}C$ ) except Output Voltage Temperature Coefficient and Detector Threshold Temperature Coefficient.

\*1) Minimum operating voltage is defined as the power supply voltage of which output voltage becomes lower than 0.1V at the detection.

\*2) Release output delay time is defined as the time to be taken for  $V_{IN}$  to change from 2V to  $(-V_{DET}) + 1V$ , and also for  $D_{OUT}$  output to become "H".

**RECOMMENDED OPERATING CONDITIONS (ELECTRICAL CHARACTERISTICS)**

All of electronic equipment should be designed that the mounted semiconductor devices operate within the recommended operating conditions. The semiconductor devices cannot operate normally over the recommended operating conditions, even if when they are used over such conditions by momentary electronic noise or surge. And the semiconductor devices may receive serious damage when they continue to operate over the recommended operating conditions.

## R1510SxxxD Series

$V_{IN}=14.0V$ ,  $C_{OUT}=6.8\mu F$ ,  $C_D=0.01\mu F$ ,  $R_{pull-up}=100k\Omega$ ,  $V_{pull-up}=5.0V$ , unless otherwise noted.

The specifications surrounded by   are guaranteed by design engineering at  $-40^{\circ}C \leq T_a \leq 105^{\circ}C$ .

For all

(Ta=25°C)

Symbol	Item	Conditions	Min.	Typ.	Max.	Unit
$V_{IN}$	Input Voltage		<span style="border: 1px solid black; padding: 0 2px;">3.5</span>		<span style="border: 1px solid black; padding: 0 2px;">36</span>	V
$I_{SS1}$	Supply Current (Low-power Consumption Mode)	$I_{OUT}=0A$		12.5	<span style="border: 1px solid black; padding: 0 2px;">26</span>	$\mu A$
$I_{SS2}$	Supply Current (High Speed Mode)	$I_{OUT}=20mA$		110	<span style="border: 1px solid black; padding: 0 2px;">174</span>	$\mu A$
$T_{TSD}$	Thermal Shutdown Temperature	Junction Temperature		140		$^{\circ}C$
$T_{TSR}$	Thermal Shutdown Released Temperature	Junction Temperature		125		$^{\circ}C$

VR

(Ta=25°C)

Symbol	Item	Conditions	Min.	Typ.	Max.	Unit	
$V_{OUT}$	Output Voltage	$I_{OUT}=1mA$ Setting Voltage: 2.5V to 12.0V	$T_a=25^{\circ}C$	$\times 0.984$		$\times 1.016$	V
			$-40^{\circ}C \leq T_a \leq 105^{\circ}C$	<span style="border: 1px solid black; padding: 0 2px;"><math>\times 0.964</math></span>		<span style="border: 1px solid black; padding: 0 2px;"><math>\times 1.045</math></span>	
$I_{OUT1}$	Output Current	$V_{IN}=V_{OUT}+3.2V$ ( $V_{OUT} < 5.0V$ ) $V_{IN}=V_{OUT}+2.0V$ ( $V_{OUT} \geq 5.0V$ )		<span style="border: 1px solid black; padding: 0 2px;">300</span>		mA	
$\Delta V_{OUT}/\Delta I_{OUT}$	Load Regulation	$V_{IN}=V_{OUT}+3.2V$ ( $V_{OUT} < 5.0V$ ) $V_{IN}=V_{OUT}+2.0V$ ( $V_{OUT} \geq 5.0V$ )				mV	
		$0.1mA \leq I_{OUT} \leq 7mA$ (Low-power Consumption Mode)	$V_{OUT} \leq 5.0V$		7		<span style="border: 1px solid black; padding: 0 2px;">13</span>
			$V_{OUT} > 5.0V$		10		<span style="border: 1px solid black; padding: 0 2px;">20</span>
		$0.1mA \leq I_{OUT} \leq 20mA$	$V_{OUT} \leq 5.0V$		10		<span style="border: 1px solid black; padding: 0 2px;">45</span>
			$V_{OUT} > 5.0V$		20		<span style="border: 1px solid black; padding: 0 2px;">75</span>
		$0.1mA \leq I_{OUT} \leq 300mA$	$V_{OUT} \leq 5.0V$		40		<span style="border: 1px solid black; padding: 0 2px;">100</span>
$V_{OUT} > 5.0V$			60	<span style="border: 1px solid black; padding: 0 2px;">170</span>			
$V_{DIF}$	Dropout Voltage	$I_{OUT}=7mA$ (Low-power Consumption Mode)	$V_{OUT} < 5.0V$		0.5	<span style="border: 1px solid black; padding: 0 2px;">1.8</span>	V
			$V_{OUT} \geq 5.0V$		0.3	<span style="border: 1px solid black; padding: 0 2px;">0.95</span>	
		$I_{OUT}=300mA$	$V_{OUT} < 5.0V$		1.5	<span style="border: 1px solid black; padding: 0 2px;">3.2</span>	
			$V_{OUT} \geq 5.0V$		1.0	<span style="border: 1px solid black; padding: 0 2px;">2.0</span>	
$I_{OUTH}$	High Speed Mode Switching Current	$I_{OUT}$ =Light Load to Heavy Load		<span style="border: 1px solid black; padding: 0 2px;">8.5</span>	12	<span style="border: 1px solid black; padding: 0 2px;">16.3</span>	mA
$I_{OUTL}$	Low-power Consumption Mode Switching Current	$I_{OUT}$ =Heavy Load to Light Load		<span style="border: 1px solid black; padding: 0 2px;">1</span>	3	<span style="border: 1px solid black; padding: 0 2px;">5</span>	mA
$\Delta V_{OUT}/\Delta V_{IN}$	Line Regulation	$3.5V \leq V_{IN} \leq 36V$ ( $2.5V \leq V_{OUT} \leq 3.5V$ ) $V_{OUT}+0.5V \leq V_{IN} \leq 36V$ ( $V_{OUT} > 3.5V$ ) $I_{OUT}=1mA$			0.01	<span style="border: 1px solid black; padding: 0 2px;">0.05</span>	%/V
$\Delta V_{OUT}/\Delta T_a$	Output Voltage Temperature Coefficient	$-40^{\circ}C \leq T_a \leq 105^{\circ}C$			$\pm 150$		ppm/ $^{\circ}C$
$I_{SC}$	Short Current Limit	$V_{OUT}=0V$			50		mA

# R1510S

NO.EA-185-140724

$V_{IN}=14.0V$ ,  $C_{OUT}=6.8\mu F$ ,  $C_D=0.01\mu F$ ,  $R_{pull-up}=100k\Omega$ ,  $V_{pull-up}=5.0V$ , unless otherwise noted.  
 The specifications surrounded by   are guaranteed by design engineering at  $-40^{\circ}C \leq T_a \leq 105^{\circ}C$ .

## VD (Ta=25°C)

Symbol	Item	Conditions	Min.	Typ.	Max.	Unit	
$-V_{DET}$	Detector Threshold	$V_{IN}$ Detector Setting Voltage: 2.3 V to 10.6V	$T_a=25^{\circ}C$	$\times 0.983$		$\times 1.017$	V
			$-40^{\circ}C \leq T_a \leq 105^{\circ}C$	<span style="border: 1px solid black; padding: 0 2px;">×0.97</span>		<span style="border: 1px solid black; padding: 0 2px;">×1.03</span>	
$V_{HYS}$	Detector Threshold Hysteresis		$-V_{DET}$ <span style="border: 1px solid black; padding: 0 2px;">×0.025</span>	$-V_{DET}$ $\times 0.05$	$-V_{DET}$ <span style="border: 1px solid black; padding: 0 2px;">×0.075</span>	V	
$V_{DDL}$	Minimum Operating Voltage*1				<span style="border: 1px solid black; padding: 0 2px;">1.8</span>	V	
$I_{OUT2}$	Output Current (Nch Driver)	$V_{IN} \geq 1.8V$ , $D_{OUT}=0.1V$	<span style="border: 1px solid black; padding: 0 2px;">0.59</span>			mA	
		$V_{IN} \geq 3.0V$ , $D_{OUT}=0.1V$	<span style="border: 1px solid black; padding: 0 2px;">1.16</span>				
		$V_{IN} \geq 4.0V$ , $D_{OUT}=0.1V$	<span style="border: 1px solid black; padding: 0 2px;">1.39</span>				
$I_{LEAK}$	Nch Driver Leakage Current	$D_{OUT}=7V$			<span style="border: 1px solid black; padding: 0 2px;">0.33</span>	$\mu A$	
$V_{RESET}$	Pull-up Voltage				<span style="border: 1px solid black; padding: 0 2px;">5.5</span>	V	
$\Delta-V_{DET}/\Delta T_a$	Detector Threshold Temperature Coefficient	$-40^{\circ}C \leq T_a \leq 105^{\circ}C$		$\pm 100$		ppm/ $^{\circ}C$	
tdelay	Release Output Delay Time *2		<span style="border: 1px solid black; padding: 0 2px;">35</span>	70	<span style="border: 1px solid black; padding: 0 2px;">150</span>	ms	

All test items listed under Electrical Characteristics are done under the pulse load condition ( $T_j \approx T_a = 25^{\circ}C$ ) except Output Voltage Temperature Coefficient and Detector Threshold Temperature Coefficient.

- \*1) Minimum operating voltage is defined as the power supply voltage of which output voltage becomes lower than 0.1V at the detection.
- \*2) Release output delay time is defined as the time to be taken for  $V_{OUT}$  to change from 2V to  $(-V_{DET}) + 1V$ , and also for  $D_{OUT}$  output to become "H".

### RECOMMENDED OPERATING CONDITIONS (ELECTRICAL CHARACTERISTICS)

All of electronic equipment should be designed that the mounted semiconductor devices operate within the recommended operating conditions. The semiconductor devices cannot operate normally over the recommended operating conditions, even if when they are used over such conditions by momentary electronic noise or surge. And the semiconductor devices may receive serious damage when they continue to operate over the recommended operating conditions.

## Product-specific Electrical Characteristics

The specifications surrounded by   are guaranteed by design engineering at  $-40^{\circ}\text{C} \leq T_a \leq 105^{\circ}\text{C}$ .

### VR

( $T_a = 25^{\circ}\text{C}$ )

Product Name	$V_{\text{OUT}}$ [V]					$V_{\text{DIF}}$ [V]			
	(Ta = 25°C)			(Ta = -40 to 105°C)		(I <sub>OUT</sub> = 7 mA: Low-power Consumption Mode)		(I <sub>OUT</sub> = 300 mA)	
	MIN.	TYP.	MAX.	MIN.	MAX.	TYP.	MAX.	TYP.	MAX.
R1510S001x	3.248	3.300	3.352	<span style="border: 1px solid black; padding: 0 2px;">3.182</span>	<span style="border: 1px solid black; padding: 0 2px;">3.448</span>	0.5	<span style="border: 1px solid black; padding: 0 2px;">1.8</span>	1.5	<span style="border: 1px solid black; padding: 0 2px;">3.2</span>
R1510S002x	2.460	2.500	2.540	<span style="border: 1px solid black; padding: 0 2px;">2.410</span>	<span style="border: 1px solid black; padding: 0 2px;">2.612</span>	0.5	<span style="border: 1px solid black; padding: 0 2px;">1.8</span>	1.5	<span style="border: 1px solid black; padding: 0 2px;">3.2</span>
R1510S003x	11.808	12.000	12.192	<span style="border: 1px solid black; padding: 0 2px;">11.568</span>	<span style="border: 1px solid black; padding: 0 2px;">12.540</span>	0.3	<span style="border: 1px solid black; padding: 0 2px;">0.95</span>	1.0	<span style="border: 1px solid black; padding: 0 2px;">2.0</span>
R1510S004x	5.511	5.600	5.689	<span style="border: 1px solid black; padding: 0 2px;">5.399</span>	<span style="border: 1px solid black; padding: 0 2px;">5.852</span>	0.3	<span style="border: 1px solid black; padding: 0 2px;">0.95</span>	1.0	<span style="border: 1px solid black; padding: 0 2px;">2.0</span>
R1510S005x	3.248	3.300	3.352	<span style="border: 1px solid black; padding: 0 2px;">3.182</span>	<span style="border: 1px solid black; padding: 0 2px;">3.448</span>	0.5	<span style="border: 1px solid black; padding: 0 2px;">1.8</span>	1.5	<span style="border: 1px solid black; padding: 0 2px;">3.2</span>
R1510S006x	3.248	3.300	3.352	<span style="border: 1px solid black; padding: 0 2px;">3.182</span>	<span style="border: 1px solid black; padding: 0 2px;">3.448</span>	0.5	<span style="border: 1px solid black; padding: 0 2px;">1.8</span>	1.5	<span style="border: 1px solid black; padding: 0 2px;">3.2</span>
R1510S007x	4.920	5.000	5.080	<span style="border: 1px solid black; padding: 0 2px;">4.820</span>	<span style="border: 1px solid black; padding: 0 2px;">5.225</span>	0.3	<span style="border: 1px solid black; padding: 0 2px;">0.95</span>	1.0	<span style="border: 1px solid black; padding: 0 2px;">2.0</span>
R1510S008x	3.248	3.300	3.352	<span style="border: 1px solid black; padding: 0 2px;">3.182</span>	<span style="border: 1px solid black; padding: 0 2px;">3.448</span>	0.5	<span style="border: 1px solid black; padding: 0 2px;">1.8</span>	1.5	<span style="border: 1px solid black; padding: 0 2px;">3.2</span>
R1510S009x	11.808	12.000	12.192	<span style="border: 1px solid black; padding: 0 2px;">11.568</span>	<span style="border: 1px solid black; padding: 0 2px;">12.540</span>	0.3	<span style="border: 1px solid black; padding: 0 2px;">0.95</span>	1.0	<span style="border: 1px solid black; padding: 0 2px;">2.0</span>
R1510S010x	3.543	3.600	3.657	<span style="border: 1px solid black; padding: 0 2px;">3.471</span>	<span style="border: 1px solid black; padding: 0 2px;">3.762</span>	0.5	<span style="border: 1px solid black; padding: 0 2px;">1.8</span>	1.5	<span style="border: 1px solid black; padding: 0 2px;">3.2</span>
R1510S011x	4.920	5.000	5.080	<span style="border: 1px solid black; padding: 0 2px;">4.820</span>	<span style="border: 1px solid black; padding: 0 2px;">5.225</span>	0.3	<span style="border: 1px solid black; padding: 0 2px;">0.95</span>	1.0	<span style="border: 1px solid black; padding: 0 2px;">2.0</span>
R1510S012x	4.920	5.000	5.080	<span style="border: 1px solid black; padding: 0 2px;">4.820</span>	<span style="border: 1px solid black; padding: 0 2px;">5.225</span>	0.3	<span style="border: 1px solid black; padding: 0 2px;">0.95</span>	1.0	<span style="border: 1px solid black; padding: 0 2px;">2.0</span>
R1510S013x	4.920	5.000	5.080	<span style="border: 1px solid black; padding: 0 2px;">4.820</span>	<span style="border: 1px solid black; padding: 0 2px;">5.225</span>	0.3	<span style="border: 1px solid black; padding: 0 2px;">0.95</span>	1.0	<span style="border: 1px solid black; padding: 0 2px;">2.0</span>

### VR (Continued)

( $T_a = 25^{\circ}\text{C}$ )

Product Name	$\Delta V_{\text{OUT}} / \Delta I_{\text{OUT}}$ [mV]					
	(0.1 mA $\leq$ I <sub>OUT</sub> $\leq$ 7 mA: Low-power Consumption Mode)		(0.1 mA $\leq$ I <sub>OUT</sub> $\leq$ 20 mA)		(0.1 mA $\leq$ I <sub>OUT</sub> $\leq$ 300 mA)	
	MIN.	MAX.	TYP.	MAX.	TYP.	MAX.
R1510S001x	7	<span style="border: 1px solid black; padding: 0 2px;">13</span>	10	<span style="border: 1px solid black; padding: 0 2px;">45</span>	40	<span style="border: 1px solid black; padding: 0 2px;">100</span>
R1510S002x	7	<span style="border: 1px solid black; padding: 0 2px;">13</span>	10	<span style="border: 1px solid black; padding: 0 2px;">45</span>	40	<span style="border: 1px solid black; padding: 0 2px;">100</span>
R1510S003x	10	<span style="border: 1px solid black; padding: 0 2px;">20</span>	20	<span style="border: 1px solid black; padding: 0 2px;">75</span>	60	<span style="border: 1px solid black; padding: 0 2px;">170</span>
R1510S004x	10	<span style="border: 1px solid black; padding: 0 2px;">20</span>	20	<span style="border: 1px solid black; padding: 0 2px;">75</span>	60	<span style="border: 1px solid black; padding: 0 2px;">170</span>
R1510S005x	7	<span style="border: 1px solid black; padding: 0 2px;">13</span>	10	<span style="border: 1px solid black; padding: 0 2px;">45</span>	40	<span style="border: 1px solid black; padding: 0 2px;">100</span>
R1510S006x	7	<span style="border: 1px solid black; padding: 0 2px;">13</span>	10	<span style="border: 1px solid black; padding: 0 2px;">45</span>	40	<span style="border: 1px solid black; padding: 0 2px;">100</span>
R1510S007x	7	<span style="border: 1px solid black; padding: 0 2px;">13</span>	10	<span style="border: 1px solid black; padding: 0 2px;">45</span>	40	<span style="border: 1px solid black; padding: 0 2px;">100</span>
R1510S008x	7	<span style="border: 1px solid black; padding: 0 2px;">13</span>	10	<span style="border: 1px solid black; padding: 0 2px;">45</span>	40	<span style="border: 1px solid black; padding: 0 2px;">100</span>
R1510S009x	10	<span style="border: 1px solid black; padding: 0 2px;">20</span>	20	<span style="border: 1px solid black; padding: 0 2px;">75</span>	60	<span style="border: 1px solid black; padding: 0 2px;">170</span>
R1510S010x	7	<span style="border: 1px solid black; padding: 0 2px;">13</span>	10	<span style="border: 1px solid black; padding: 0 2px;">45</span>	40	<span style="border: 1px solid black; padding: 0 2px;">100</span>
R1510S011x	7	<span style="border: 1px solid black; padding: 0 2px;">13</span>	10	<span style="border: 1px solid black; padding: 0 2px;">45</span>	40	<span style="border: 1px solid black; padding: 0 2px;">100</span>
R1510S012x	7	<span style="border: 1px solid black; padding: 0 2px;">13</span>	10	<span style="border: 1px solid black; padding: 0 2px;">45</span>	40	<span style="border: 1px solid black; padding: 0 2px;">100</span>
R1510S013x	7	<span style="border: 1px solid black; padding: 0 2px;">13</span>	10	<span style="border: 1px solid black; padding: 0 2px;">45</span>	40	<span style="border: 1px solid black; padding: 0 2px;">100</span>

**R1510S**

NO.EA-185-140724

The specifications surrounded by   are guaranteed by design engineering at  $-40^{\circ}\text{C} \leq T_a \leq 105^{\circ}\text{C}$ .**VD**

(Ta = 25°C)

Product Name	-V <sub>DET</sub> [V] (Ta = 25°C)			-V <sub>DET</sub> [V] (Ta = -40 to 105°C)		V <sub>HYS</sub> [V]		
	MIN.	TYP.	MAX.	MIN.	MAX.	MIN.	TYP.	MAX.
R1510S001x	2.655	2.700	2.745	<span style="border: 1px solid black; padding: 0 2px;">2.619</span>	<span style="border: 1px solid black; padding: 0 2px;">2.781</span>	<span style="border: 1px solid black; padding: 0 2px;">0.068</span>	0.135	<span style="border: 1px solid black; padding: 0 2px;">0.203</span>
R1510S002x	4.031	4.100	4.169	<span style="border: 1px solid black; padding: 0 2px;">3.977</span>	<span style="border: 1px solid black; padding: 0 2px;">4.223</span>	<span style="border: 1px solid black; padding: 0 2px;">0.103</span>	0.205	<span style="border: 1px solid black; padding: 0 2px;">0.308</span>
R1510S003x	4.915	5.000	5.085	<span style="border: 1px solid black; padding: 0 2px;">4.850</span>	<span style="border: 1px solid black; padding: 0 2px;">5.150</span>	<span style="border: 1px solid black; padding: 0 2px;">0.125</span>	0.250	<span style="border: 1px solid black; padding: 0 2px;">0.375</span>
R1510S004x	2.949	3.000	3.051	<span style="border: 1px solid black; padding: 0 2px;">2.910</span>	<span style="border: 1px solid black; padding: 0 2px;">3.090</span>	<span style="border: 1px solid black; padding: 0 2px;">0.075</span>	0.150	<span style="border: 1px solid black; padding: 0 2px;">0.225</span>
R1510S005x	3.736	3.800	3.864	<span style="border: 1px solid black; padding: 0 2px;">3.686</span>	<span style="border: 1px solid black; padding: 0 2px;">3.914</span>	<span style="border: 1px solid black; padding: 0 2px;">0.095</span>	0.190	<span style="border: 1px solid black; padding: 0 2px;">0.285</span>
R1510S006x	3.539	3.600	3.661	<span style="border: 1px solid black; padding: 0 2px;">3.492</span>	<span style="border: 1px solid black; padding: 0 2px;">3.708</span>	<span style="border: 1px solid black; padding: 0 2px;">0.090</span>	0.180	<span style="border: 1px solid black; padding: 0 2px;">0.270</span>
R1510S007x	4.424	4.500	4.576	<span style="border: 1px solid black; padding: 0 2px;">4.365</span>	<span style="border: 1px solid black; padding: 0 2px;">4.635</span>	<span style="border: 1px solid black; padding: 0 2px;">0.113</span>	0.225	<span style="border: 1px solid black; padding: 0 2px;">0.338</span>
R1510S008x	2.753	2.800	2.847	<span style="border: 1px solid black; padding: 0 2px;">2.716</span>	<span style="border: 1px solid black; padding: 0 2px;">2.884</span>	<span style="border: 1px solid black; padding: 0 2px;">0.070</span>	0.140	<span style="border: 1px solid black; padding: 0 2px;">0.210</span>
R1510S009x	4.129	4.200	4.271	<span style="border: 1px solid black; padding: 0 2px;">4.074</span>	<span style="border: 1px solid black; padding: 0 2px;">4.326</span>	<span style="border: 1px solid black; padding: 0 2px;">0.105</span>	0.210	<span style="border: 1px solid black; padding: 0 2px;">0.315</span>
R1510S010x	4.227	4.300	4.373	<span style="border: 1px solid black; padding: 0 2px;">4.171</span>	<span style="border: 1px solid black; padding: 0 2px;">4.429</span>	<span style="border: 1px solid black; padding: 0 2px;">0.108</span>	0.215	<span style="border: 1px solid black; padding: 0 2px;">0.323</span>
R1510S011x	2.261	2.300	2.339	<span style="border: 1px solid black; padding: 0 2px;">2.231</span>	<span style="border: 1px solid black; padding: 0 2px;">2.369</span>	<span style="border: 1px solid black; padding: 0 2px;">0.058</span>	0.115	<span style="border: 1px solid black; padding: 0 2px;">0.173</span>
R1510S012x	4.129	4.200	4.271	<span style="border: 1px solid black; padding: 0 2px;">4.074</span>	<span style="border: 1px solid black; padding: 0 2px;">4.326</span>	<span style="border: 1px solid black; padding: 0 2px;">0.105</span>	0.210	<span style="border: 1px solid black; padding: 0 2px;">0.315</span>
R1510S013x	9.830	10.000	10.170	<span style="border: 1px solid black; padding: 0 2px;">9.700</span>	<span style="border: 1px solid black; padding: 0 2px;">10.300</span>	<span style="border: 1px solid black; padding: 0 2px;">0.250</span>	0.500	<span style="border: 1px solid black; padding: 0 2px;">0.750</span>

## TYPICAL APPLICATIONS

### R1510SxxxA

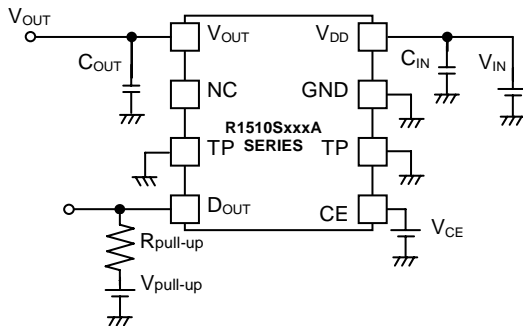

### R1510SxxxB

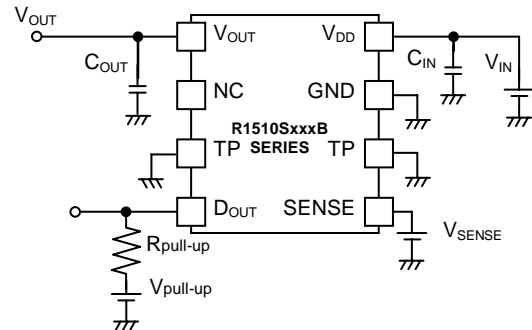

### R1510SxxxC/D

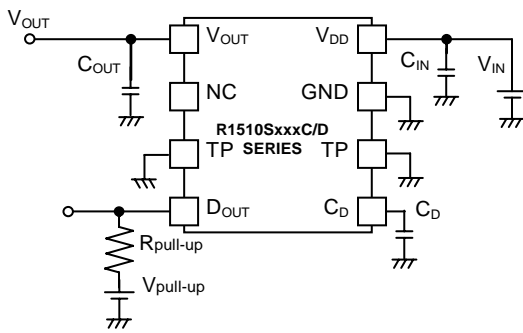

$C_{IN}=0.1\mu\text{F}$ ,  $C_{OUT}=6.8\mu\text{F}$  (Ceramic)  
 $R_{pull-up}=100\text{k}\Omega$

## TECHNICAL NOTES

### Phase Compensation

This IC is using the capacitance of output capacitor ( $C_{OUT}$ ) and the ESR as phase compensation for the stable operation of the IC even if the output load varies. Therefore, please make sure to use a capacitor ( $C_{OUT}$ ) with  $6.8\mu\text{F}$  or more.

If the ESR value is large, the output may result in unstable, therefore, please make full evaluation on the temperature characteristics and the frequency characteristics.

### PCB Layout and GND Wiring

The high impedances of  $V_{DD}$  and GND could be a reason for the noise pickup and unstable operation. Therefore, make the impedances of  $V_{DD}$  and GND as low as possible. A capacitor ( $C_{IN}$ ) with  $0.1\mu\text{F}$  or more has to be connected between  $V_{DD}$  pin and GND pin, and the wirings between them have to be short as possible. The capacitor ( $C_{OUT}$ ) for phase compensation has to be connected between  $V_{OUT}$  pin and GND pin, and the wirings between them have to be short as possible.

## OPERATION MANUAL

### Voltage Regulator (VR)

Voltage Regulator (VR) operates within the input voltage range of 3.5V to 36V. The output voltage is adjustable within the range of 2.5V to 12V by 0.1V step. By changing the current value of the control circuit according to the load current, the supply current at the light load condition can be minimized and also be able to achieve high speed response. When the load current becomes 12mA (Typ.) or more, the control circuit switches to high-speed mode and when the load current becomes 3mA or lower, it switches to low-power consumption mode. Hysteresis is set for the output current between 3mA to 12mA (Typ.).

These current values are internally fixed inside the IC. When the mode switching is caused by the load current change, the output voltage will be changed as the graph below shows. The load current dependencies (Load Regulation) of output voltage in Electrical Characteristics have been tested at the following points: 0.1mA, 7mA (Low-power consumption mode), 20mA, and 300mA.

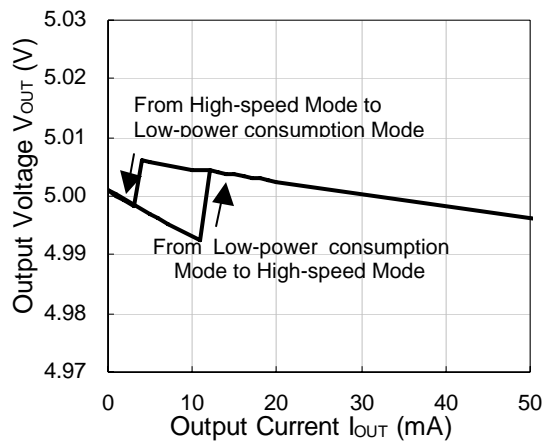

During the period of 100 $\mu$ sec immediately after High-speed mode is switched to Low-power consumption mode, the current value ( $I_{OUTH}$ ), which switches Low-power consumption mode back to High-speed mode, is increased 3 times. Therefore, during this time period, the IC can still operate with Low-power consumption mode even if the load current is between 12mA to 36mA (Typ.).

R1510SxxxA can turn on and off the operation of VR by CE pin.

### Voltage Detector (VD)

Voltage Detector (VD) operates within the input voltage range of 1.8V to 36V (R1510SxxxA/C/D) and 3.0V to 36V (R1510SxxxB). The detector threshold is adjustable in the range of 2.3V to 12V by 0.1V step. If the monitor voltage is lower than the detector threshold,  $D_{OUT}$  outputs "L". In the case of R1510SxxA/B, if the monitor voltage becomes more than the released voltage,  $D_{OUT}$  outputs "H". In the case of R1510SxxxC/D, if the monitor voltage becomes more than the released voltage, the capacitor of the release output delay time pin ( $C_D$ ) starts to get charged.  $D_{OUT}$  output maintains "L" until  $C_D$  reaches to the threshold value. Once  $C_D$  value becomes more than the threshold value,  $D_{OUT}$  outputs "H". In the case of R1510SxxxC/D, if the monitor voltage becomes lower than the detector threshold, the capacitor of  $C_D$  starts to get discharged. Therefore, if the monitor voltage becomes more than the released voltage without electrical discharge, the release output delay time afterwards becomes less than the existing release output delay time ( $t_{DELAY}$ ).



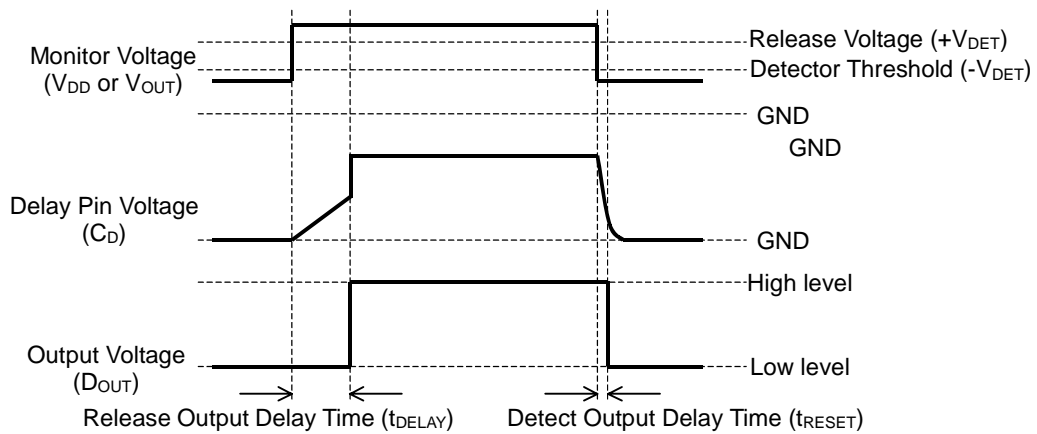

### R1510Sxxx C/D

If  $V_{IN}$  voltage is raised suddenly from the less than the minimum operating voltage to the less than the release voltage,  $V_{IN}$  voltage momentarily passes through the unstable range (from 0V to the minimum operating voltage), therefore,  $D_{OUT}$  may output "H" (unstable) once then output "L" afterwards. Similarly, if  $V_{IN}$  voltage is raised from the less than the minimum operating voltage to the more than the release voltage,  $V_{IN}$  momentarily passes through the unstable range (from 0V to the minimum operating voltage), therefore,  $D_{OUT}$  may output "H" once.

### Release Output Delay Time

The release output delay time (Power-on Reset Time ( $t_{DELAY}$ )) of R1510Sxxx C/D can be set by the capacitor of  $C_D$  pin. The relationship between the capacitor capacitance and  $t_{DELAY}$  is as shown in the following equation.

$$t_{DELAY}(s)=7.0 \times 10^5 \times C_D(F)$$

The upper limit of the capacitance value for the  $C_D$  pin capacitor is  $1\mu F$ . The capacitor operates normally with more than  $1\mu F$ ; however, if the setting time ( $t_{DELAY}$ ) is set longer, the setting time differences could become bigger. Also, if the detect output delay time becomes longer; the response of the VD output pin will be slow to make a momentary stop.

If the  $V_{DD}$  pin voltage is decreased with more than the through rate as it is shown in the graph below, the IC does not operate normally. If there's any possibility of this, please minimize the voltage fluctuation of  $V_{DD}$  pin by using  $C_{IN}$ .

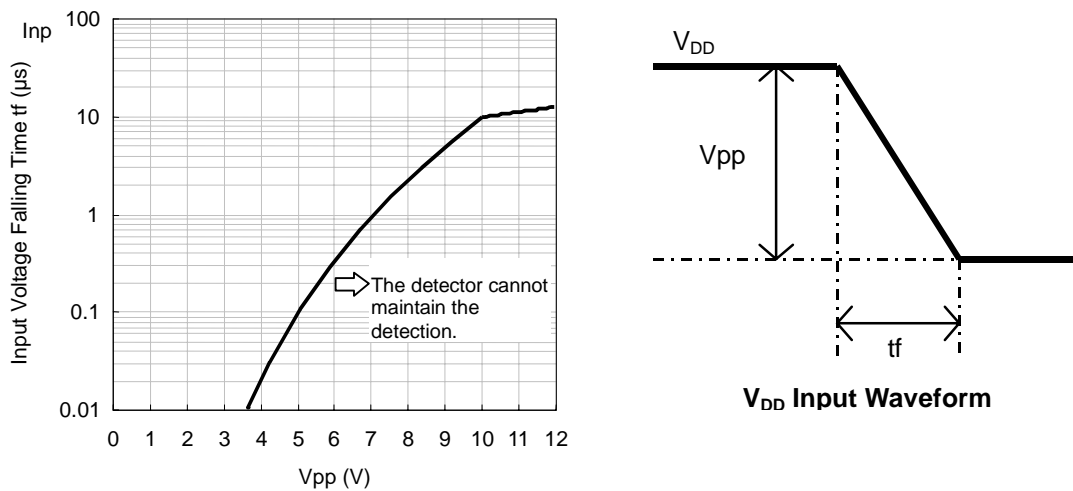

### Thermal Shutdown

If the junction temperature ( $T_j$ ) becomes more than  $140^\circ C$ (Typ.) due to the heat generation in the voltage regulator, the output driver will be turned off to protect the IC and the voltage regulator output will be turned off. If the junction temperature becomes less than  $125^\circ C$ (Typ.), the output driver will be turned on and the voltage regulator output will be turned on. Unless the cause of the heat generation is not removed, the voltage regulator repeats turns on and off, so the output voltage will be a pulsing form.

### R1510Sxxx D Voltage Setting

The voltage detector (VD) of R1510Sxxx D detects the output voltage drop of the voltage regulator (VR). If the VD release voltage is set to more than the VR output voltage, the VD will not be canceled even if the VR output voltage returns to the normal value after VD detected the output voltage drop of VR. To avoid this, there have to be voltage differences between the voltage regulator's output voltage ( $V_{OUT}$ ) and the voltage detector's release voltage ( $+V_{DET}$ ). Also, the following conditions have to be met.

$$(VR \text{ Output Setting Voltage}) \times 0.964 > (VD \text{ Detect Setting Voltage}) \times 1.03 \times 1.075$$

In case of using the products with the VR output voltage and the VD detector threshold that is not met the above conditions, please make sure to give greater consideration on the system operation before use.

## PACKAGE INFORMATION

### POWER DISSIPATION (HSOP-8E)

Power Dissipation ( $P_D$ ) depends on conditions of mounting on board.  
This specification is based on the measurement at the condition below:

#### Measurement conditions

	Ultra High Wattage land pattern
Environment	Mounting on board (Wind velocity=0m/s)
Board Material	Glass cloth epoxy plastic (4 layers)
Board Dimensions	76.2mm x 114.3mm x 0.8mm
Copper Ratio	Top side, Back side : 50mm square : Approx.95% 2nd, 3rd Layer: 50mm square : Approx.100%
Through – holes	$\phi$ 0.4mm x 21 pcs

#### Measurement Results

( $T_a=25^\circ\text{C}$ ,  $T_{j\text{max}}=125^\circ\text{C}$ )

	Ultra High Wattage land pattern
Power Dissipation	2.9W
Thermal Resistance	$\theta_{ja} = (125-25^\circ\text{C})/2.9\text{W} = 35^\circ\text{C/W}$
	$\theta_{jc} = 10^\circ\text{C/W}$

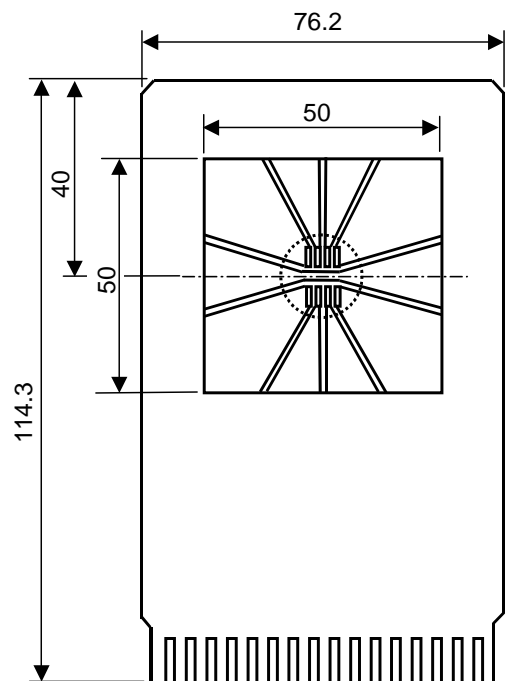
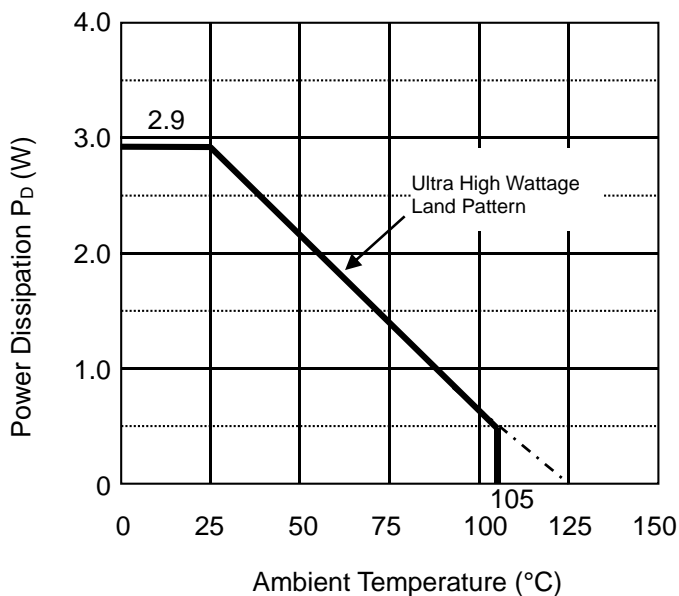

Measurement Board Pattern

IC Mount Area (Unit : mm)

**R1510S**

NO.EA-185-140724

**PACKAGE DIMENSIONS (HSOP-8E)**

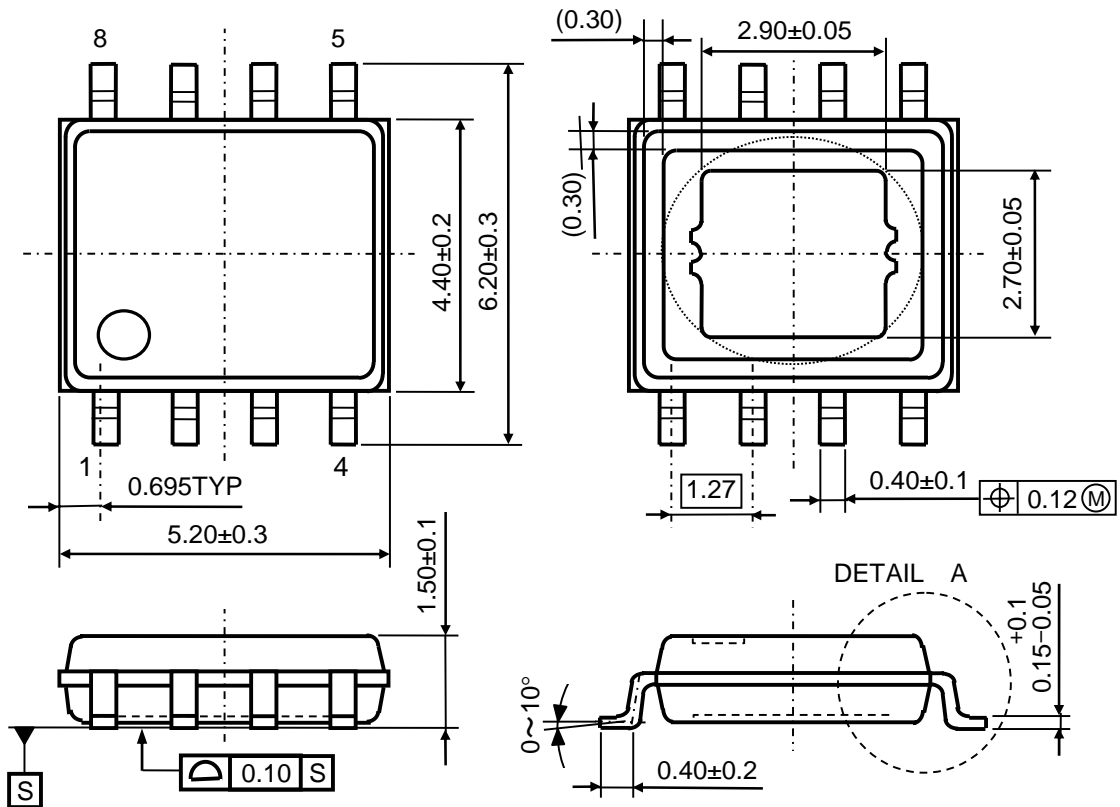

The tab on the bottom of the package enhances thermal performance and is electrically connected to GND (substrate level). It is recommended that the tab be connected to the ground plane on the board, or otherwise be left floating.

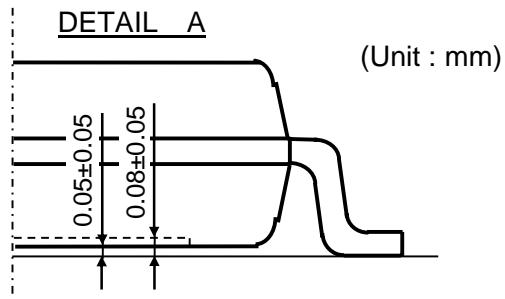

**MARK SPECIFICATION (HSOP-8E)**

①②③④⑤⑥: Product Code ... **Refer to MARK SPECIFICATION TABLE**

⑦⑧⑨: Lot Number ... Alphanumeric Serial Number

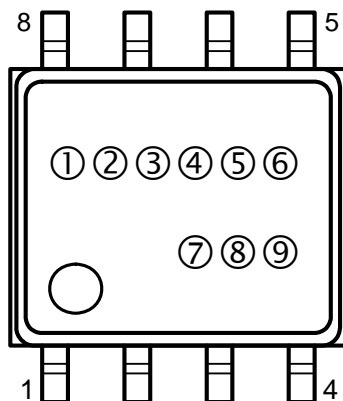

## MARK SPECIFICATION TABLE (HSOP-8E)

## R1510SxxxA

Product Name	①②③④⑤⑥	V <sub>SET</sub>	
		VR	VD
R1510S001A	<b>R S 0 0 3 A</b>	3.3V	2.7V
R1510S002A	<b>R S 0 0 3 E</b>	2.5V	4.1V
R1510S003A	<b>R S 0 0 3 J</b>	12.0V	5.0V
R1510S004A	<b>R S 0 0 3 N</b>	5.6V	3.0V
R1510S005A	<b>R S 0 0 3 S</b>	3.3V	3.8V
R1510S006A	<b>R S 0 0 3 W</b>	3.3V	3.6V
R1510S007A	<b>R S 0 0 4 A</b>	5.0V	4.5V
R1510S008A	<b>R S 0 0 4 E</b>	3.3V	2.8V
R1510S009A	<b>R S 0 0 4 J</b>	12.0V	4.2V
R1510S010A	<b>R S 0 0 4 N</b>	3.6V	4.3V
R1510S011A	<b>R S 0 0 4 S</b>	5.0V	2.3V
R1510S012A	<b>R S 0 0 4 W</b>	5.0V	4.2V
R1510S013A	<b>R S 0 0 6 A</b>	5.0V	10.0V

## R1510SxxxB

Product Name	①②③④⑤⑥	V <sub>SET</sub>	
		VR	VD
R1510S001B	<b>R S 0 0 3 B</b>	3.3V	2.7V
R1510S002B	<b>R S 0 0 3 F</b>	2.5V	4.1V
R1510S003B	<b>R S 0 0 3 K</b>	12.0V	5.0V
R1510S004B	<b>R S 0 0 3 P</b>	5.6V	3.0V
R1510S005B	<b>R S 0 0 3 T</b>	3.3V	3.8V
R1510S006B	<b>R S 0 0 3 X</b>	3.3V	3.6V
R1510S007B	<b>R S 0 0 4 B</b>	5.0V	4.5V
R1510S008B	<b>R S 0 0 4 F</b>	3.3V	2.8V
R1510S009B	<b>R S 0 0 4 K</b>	12.0V	4.2V
R1510S010B	<b>R S 0 0 4 P</b>	3.6V	4.3V
R1510S011B	<b>R S 0 0 4 T</b>	5.0V	2.3V
R1510S012B	<b>R S 0 0 4 X</b>	5.0V	4.2V

## R1510SxxxC

Product Name	①②③④⑤⑥	V <sub>SET</sub>	
		VR	VD
R1510S001C	<b>R S 0 0 3 C</b>	3.3V	2.7V
R1510S002C	<b>R S 0 0 3 G</b>	2.5V	4.1V
R1510S003C	<b>R S 0 0 3 L</b>	12.0V	5.0V
R1510S004C	<b>R S 0 0 3 Q</b>	5.6V	3.0V
R1510S005C	<b>R S 0 0 3 U</b>	3.3V	3.8V
R1510S006C	<b>R S 0 0 3 Y</b>	3.3V	3.6V
R1510S007C	<b>R S 0 0 4 C</b>	5.0V	4.5V
R1510S008C	<b>R S 0 0 4 G</b>	3.3V	2.8V
R1510S009C	<b>R S 0 0 4 L</b>	12.0V	4.2V
R1510S010C	<b>R S 0 0 4 Q</b>	3.6V	4.3V
R1510S011C	<b>R S 0 0 4 U</b>	5.0V	2.3V
R1510S012C	<b>R S 0 0 4 Y</b>	5.0V	4.2V

## R1510SxxxD

Product Name	①②③④⑤⑥	V <sub>SET</sub>	
		VR	VD
R1510S001D	<b>R S 0 0 3 D</b>	3.3V	2.7V
R1510S003D	<b>R S 0 0 3 M</b>	12.0V	5.0V
R1510S004D	<b>R S 0 0 3 R</b>	5.6V	3.0V
R1510S008D	<b>R S 0 0 4 H</b>	3.3V	2.8V
R1510S009D	<b>R S 0 0 4 M</b>	12.0V	4.2V
R1510S011D	<b>R S 0 0 4 V</b>	5.0V	2.3V
R1510S012D	<b>R S 0 0 4 Z</b>	5.0V	4.2V

\*) The followings do not exist:

R1510S002D, 005D, 006D, 007D, 010D

### TYPICAL CHARACTERISTICS

Note: Typical Characteristics are intended to be used as reference data; they are not guaranteed.

#### 1) Output Voltage vs. Output Current (Ta=25°C)

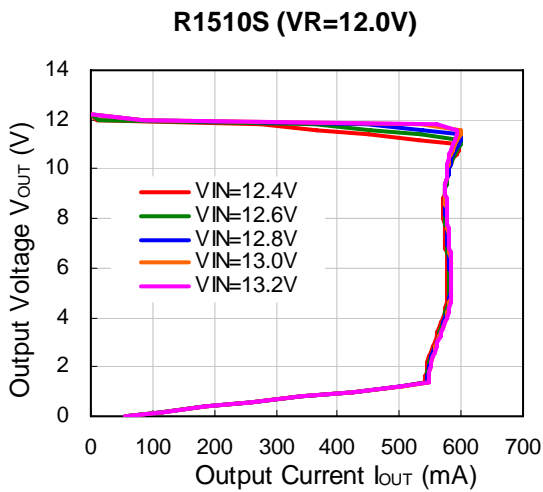
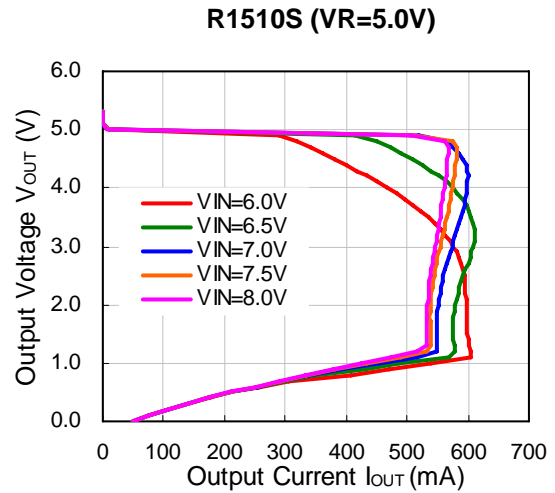
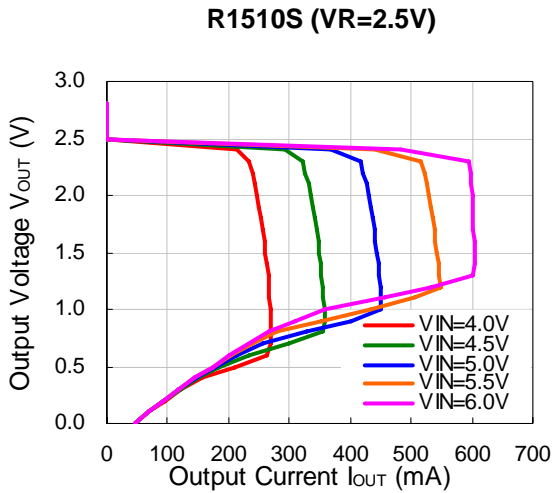

#### 2) Output Voltage vs. Input Voltage (Ta=25°C)

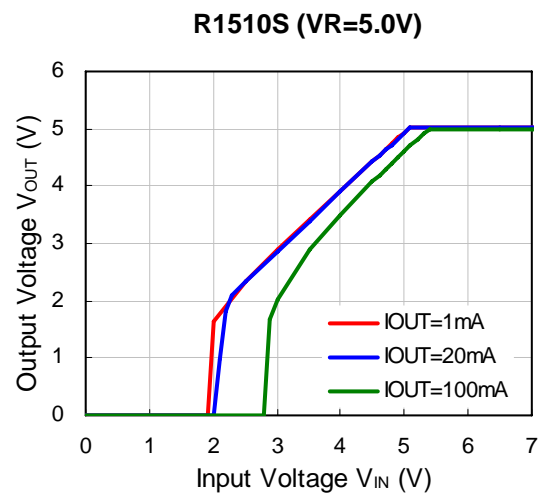
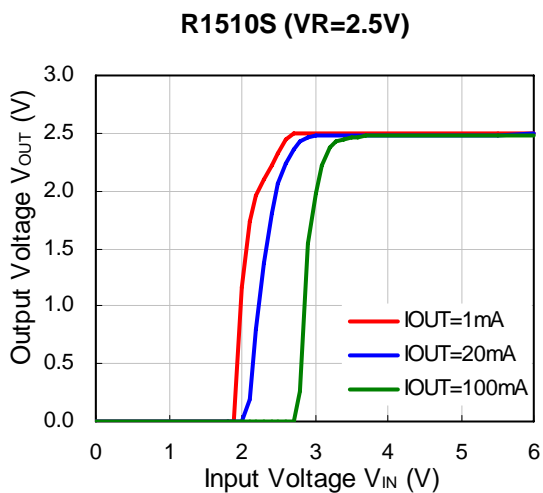

R1510S (VR=12.0V)

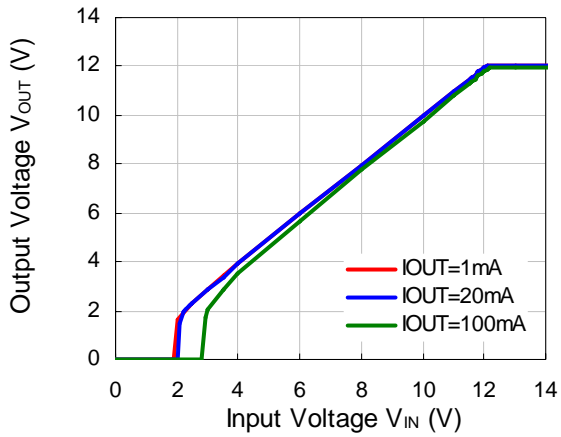

3) Dropout Voltage vs. Output Current

R1510S (VR=2.5V)

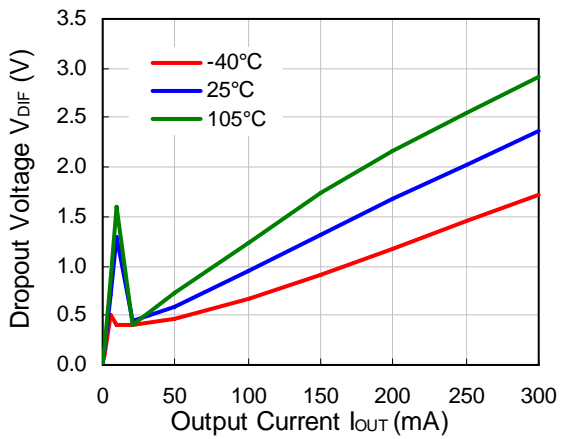

R1510S (VR=5.0V)

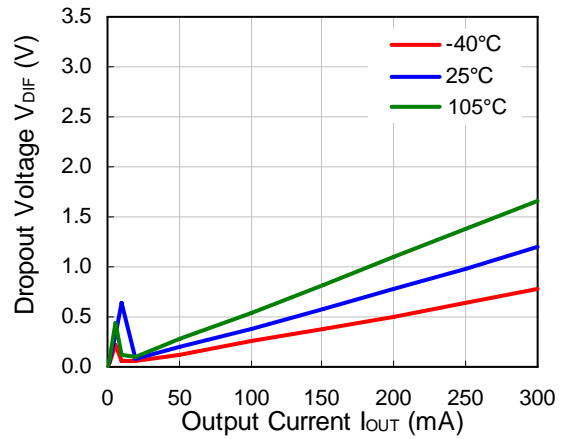

R1510S (VR=12.0V)

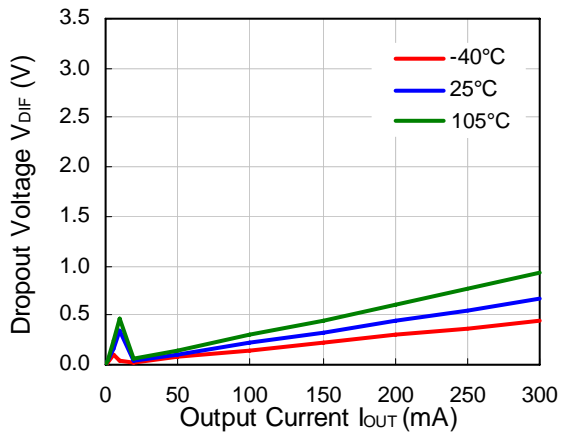

# R1510S

NO.EA-185-140724

## 4) Output Voltage vs. Output Current ( $T_a=25^\circ\text{C}$ )

### R1510S (VR=2.5V)

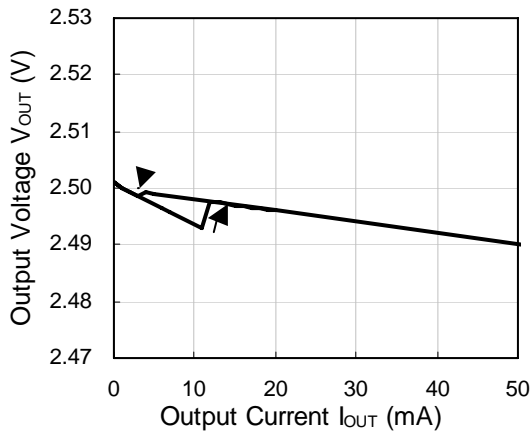

### R1510S (VR=5.0V)

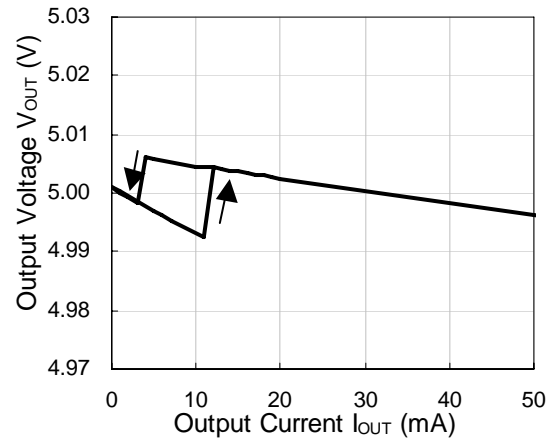

### R1510S (VR=12.0V)

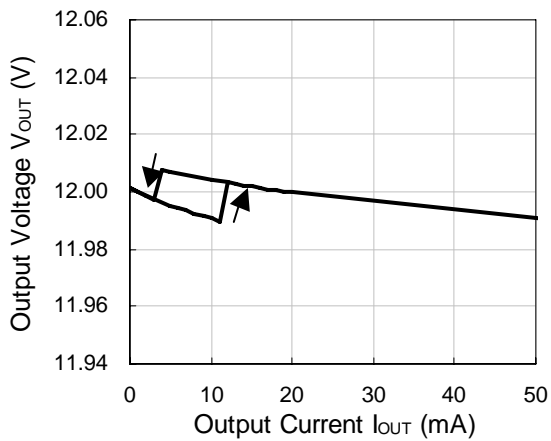

## 5) Output Voltage vs. Operating Temperature

### R1510S (VR=2.5V)

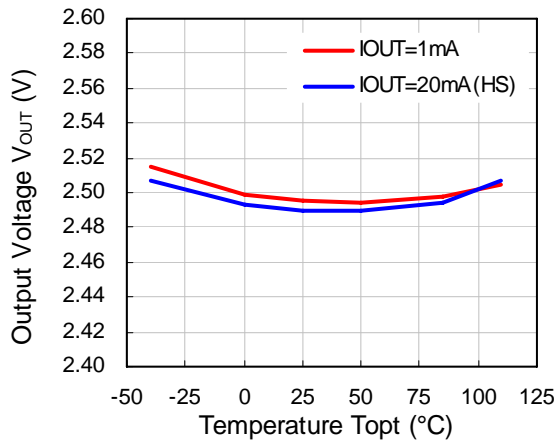

### R1510S (VR=5.0V)

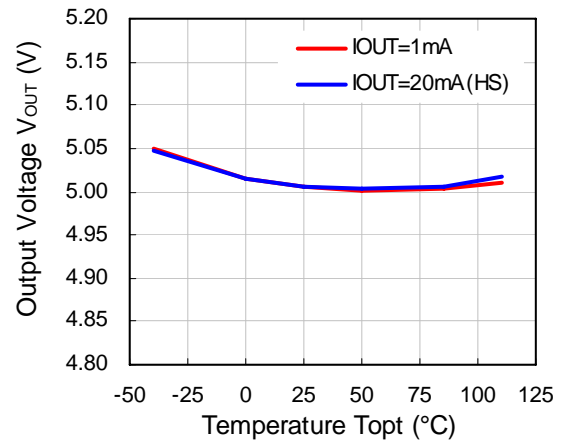



R1510S (VR=12.0V)

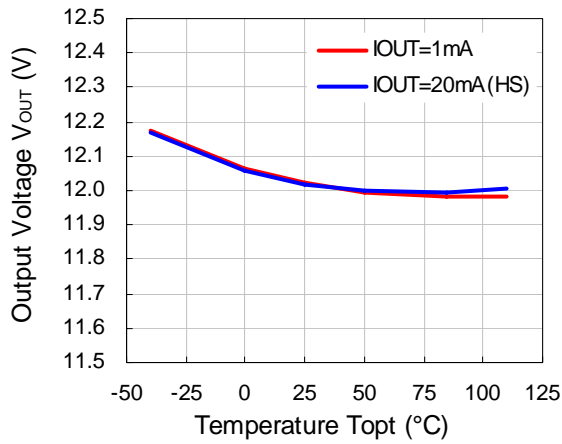

6) Supply Current vs. Input Voltage

R1510S (VR=2.5V, VD=2.3V)

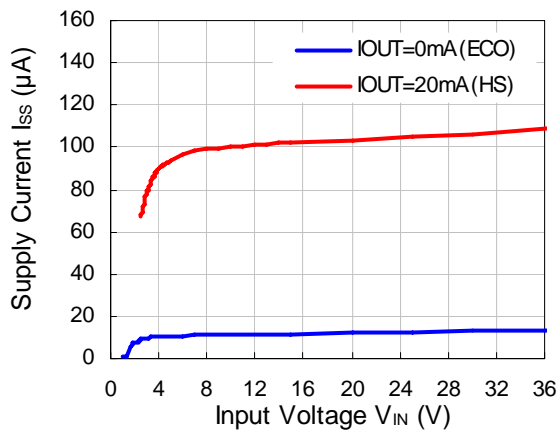

R1510S (VR=5.0V, VD=4.5V)

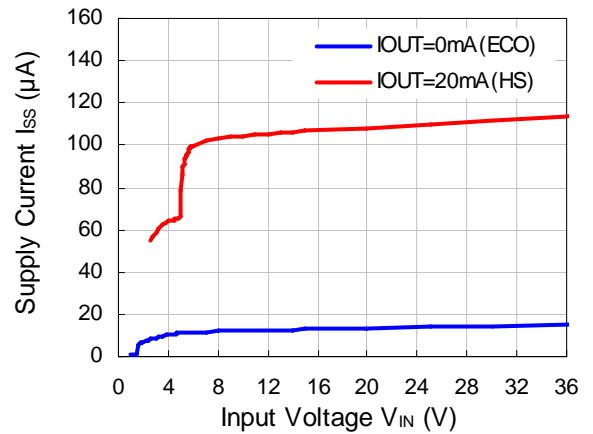

R1510S (VR=12.0V, VD=11.0V)

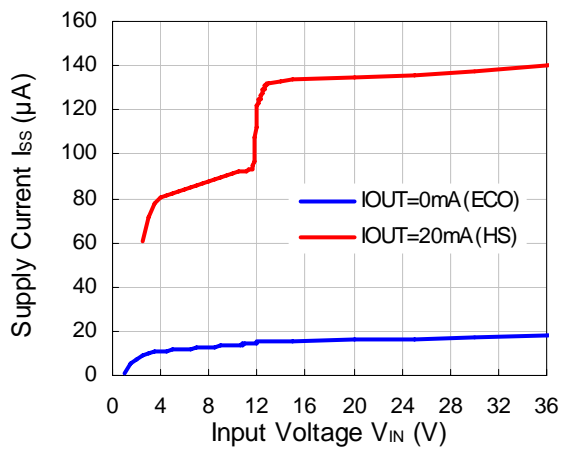

**7) Supply Current vs. Operating Temperature**

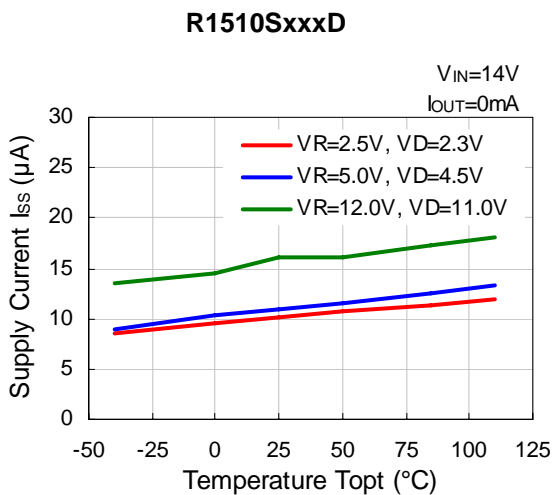
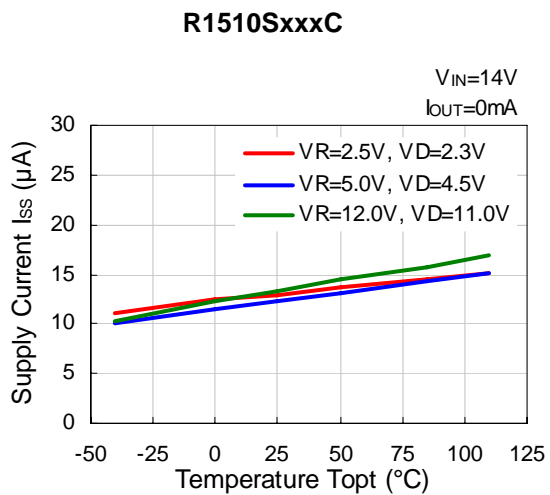
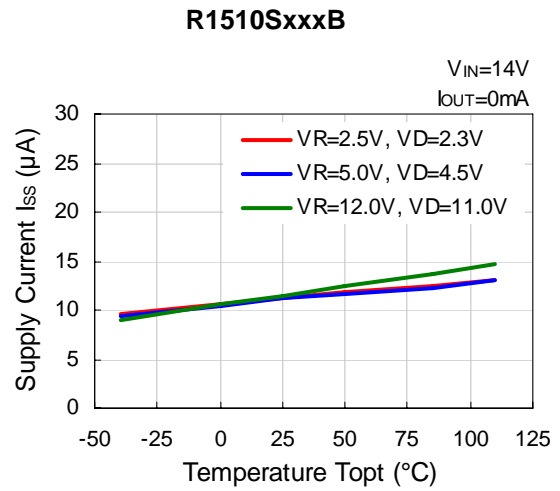
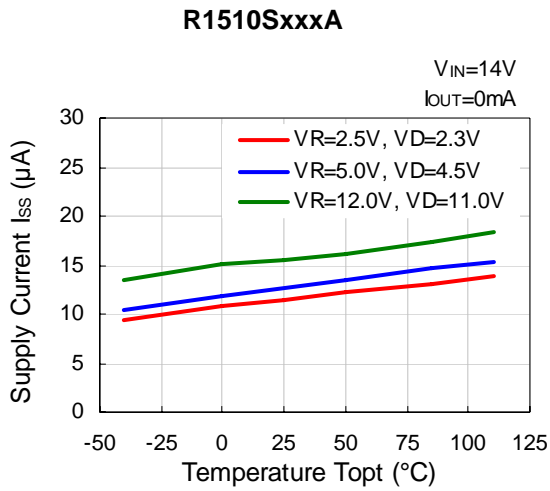

**8) Supply Current vs. Output Current ( $T_a=25^{\circ}C$ )**

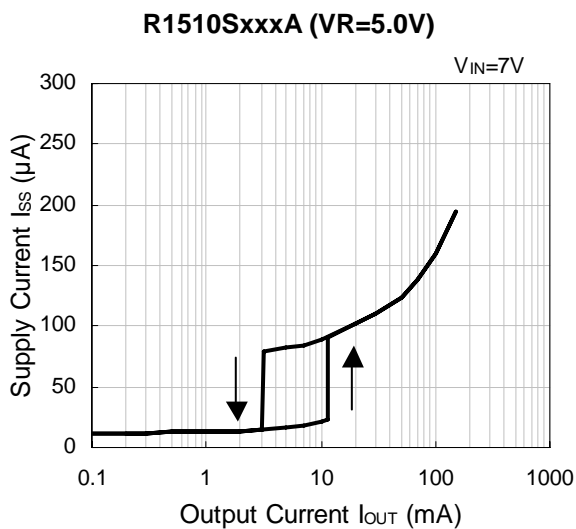

9) Mode Switching Load Current vs. Operating Temperature

R1510S

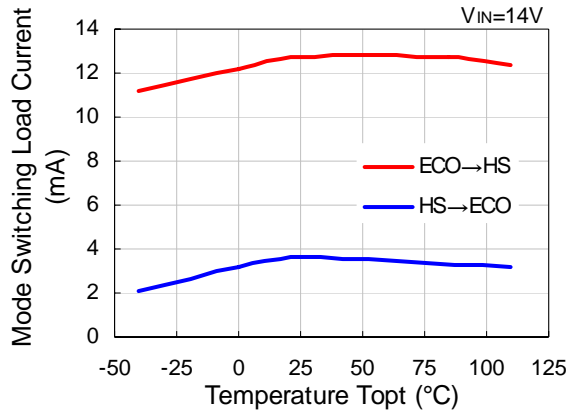

10) Dropout Voltage vs. Set Output Voltage ( $T_a=25^\circ C$ )

R1510S

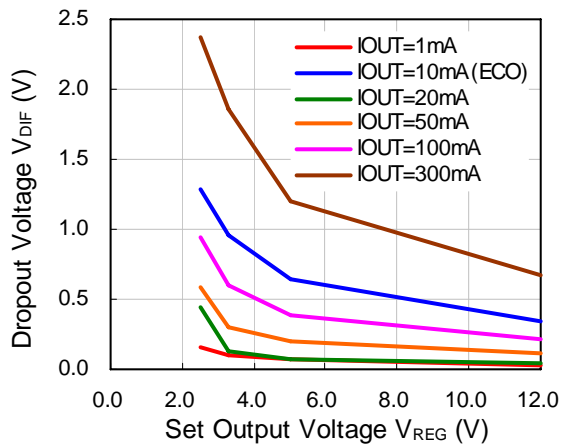

11) Ripple Rejection vs. Frequency ( $T_a=25^\circ C$ )

R1510S ( $V_R=2.5V$ )

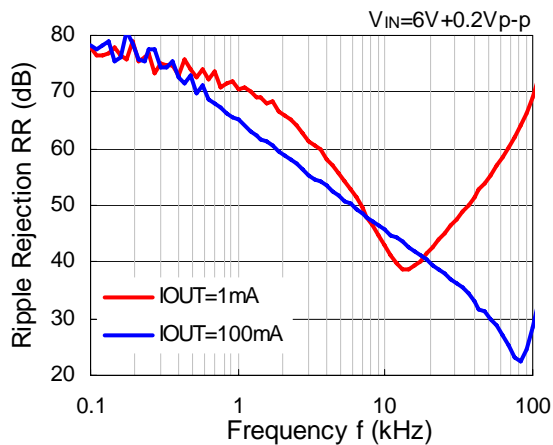

R1510S ( $V_R=5.0V$ )

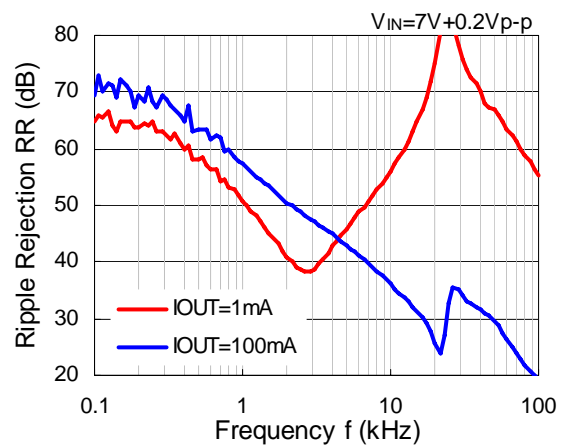

# R1510S

NO.EA-185-140724

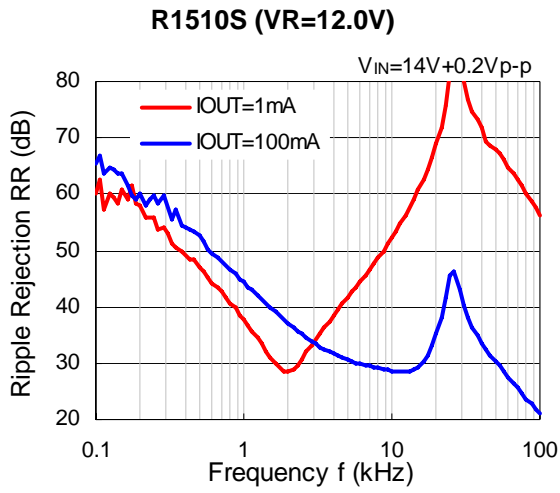

## 12) Ripple Rejection vs. Input Voltage (Ta=25°C)

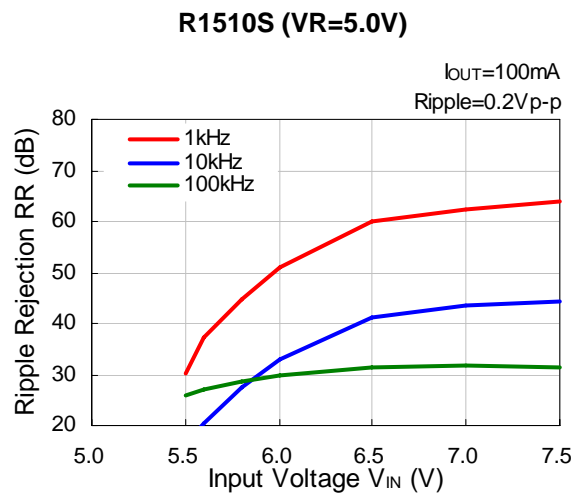
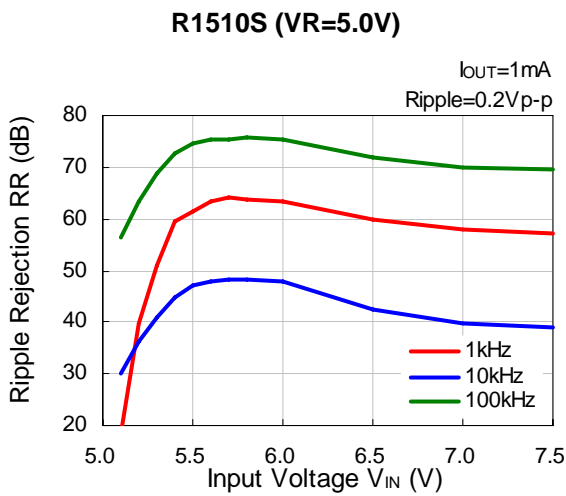
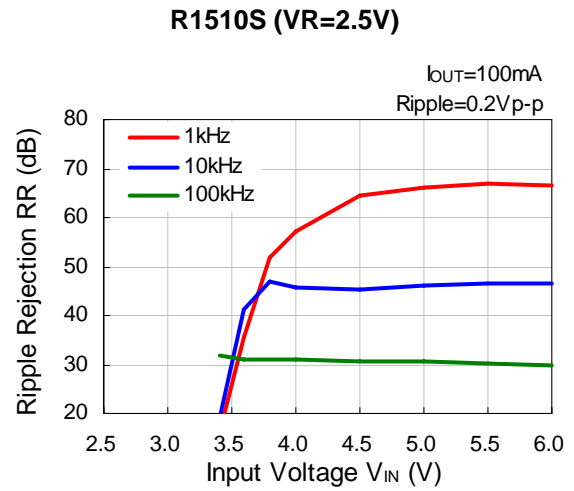
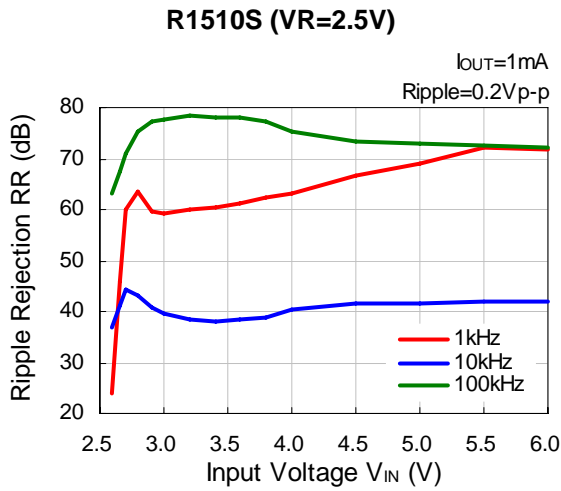

R1510S (VR=12.0V)

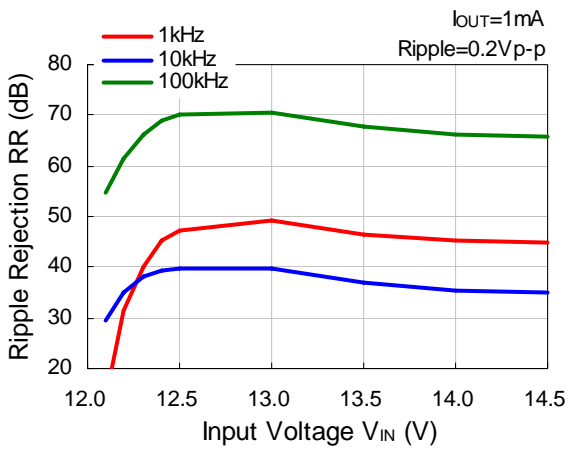

R1510S (VR=12.0V)

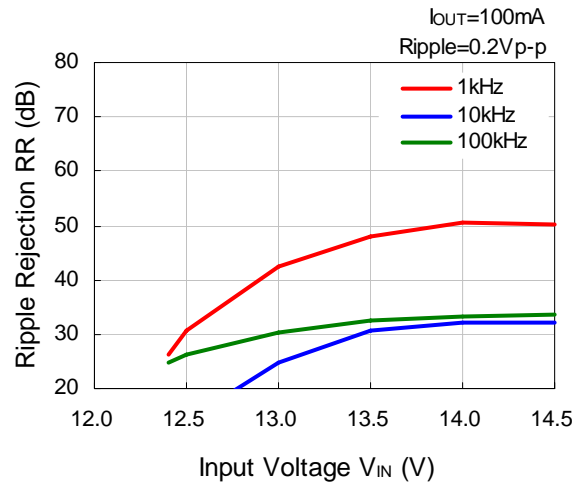

13) Input Transient Response ( $T_a=25^\circ C$ )

R1510S (VR=2.5V)

$V_{DD}=3.5V$  to  $4.5V$ ,  $C_{OUT}=6.8\mu F$ ,  $I_{OUT}=1mA$ ,  $t_f$ ,  $t_r=1\mu s$

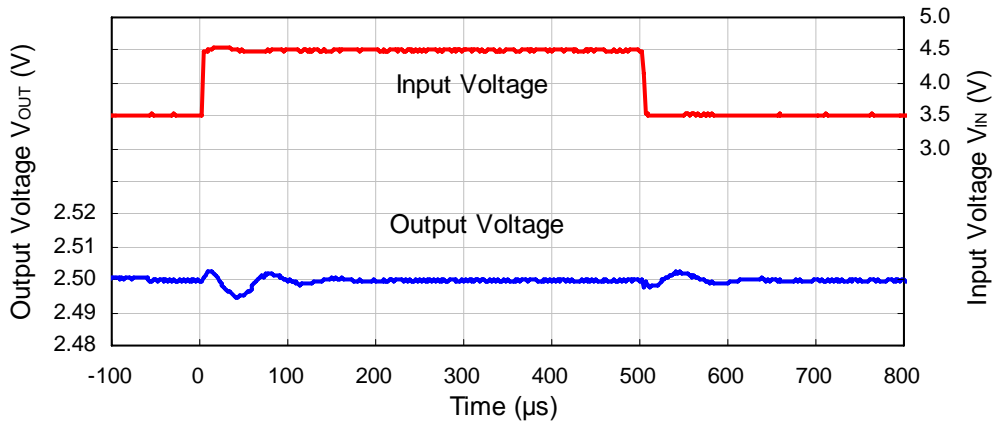

R1510S (VR=5.0V)

$V_{DD}=6V$  to  $7V$ ,  $C_{OUT}=6.8\mu F$ ,  $I_{OUT}=1mA$ ,  $t_f$ ,  $t_r=1\mu s$

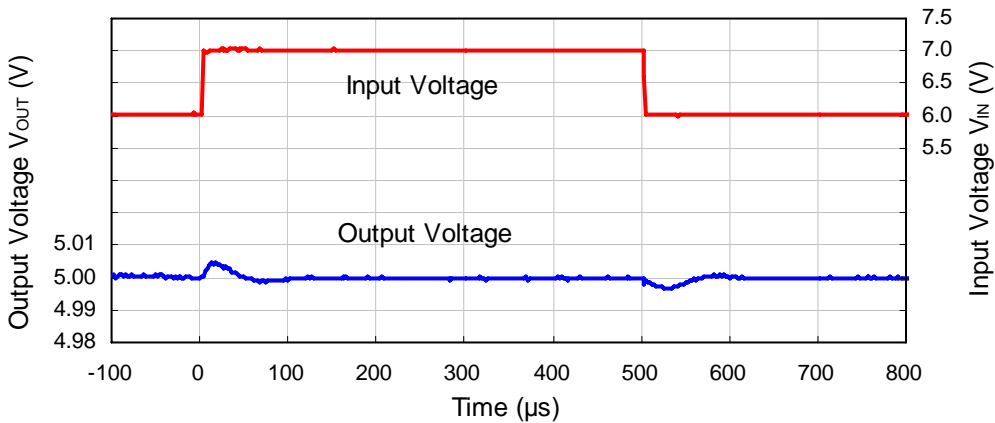

**R1510S (VR=12.0V)**

$V_{DD}=13V$  to  $14V$ ,  $C_{OUT}=6.8\mu F$ ,  $I_{OUT}=1mA$ ,  $t_f, t_r=1\mu s$

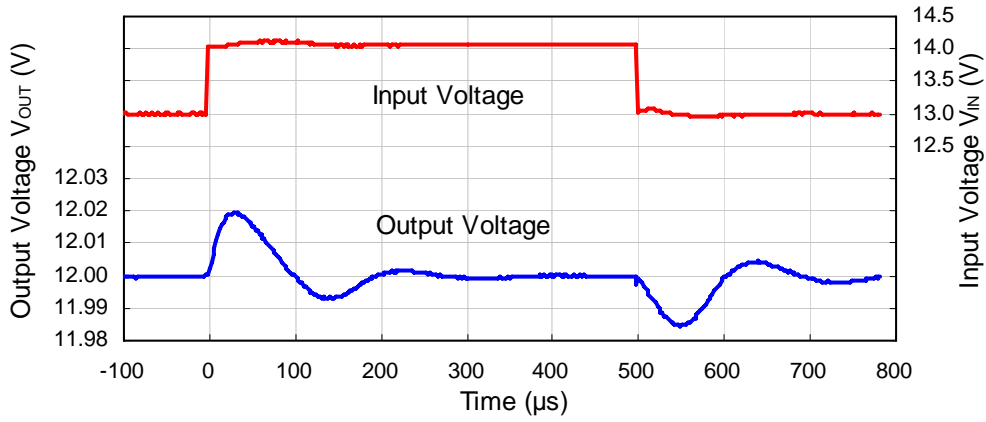

**R1510S (VR=2.5V)**

$V_{DD}=3.5V$  to  $4.5V$ ,  $C_{OUT}=6.8\mu F$ ,  $I_{OUT}=10mA(HS)$ ,  $t_f, t_r=1\mu s$

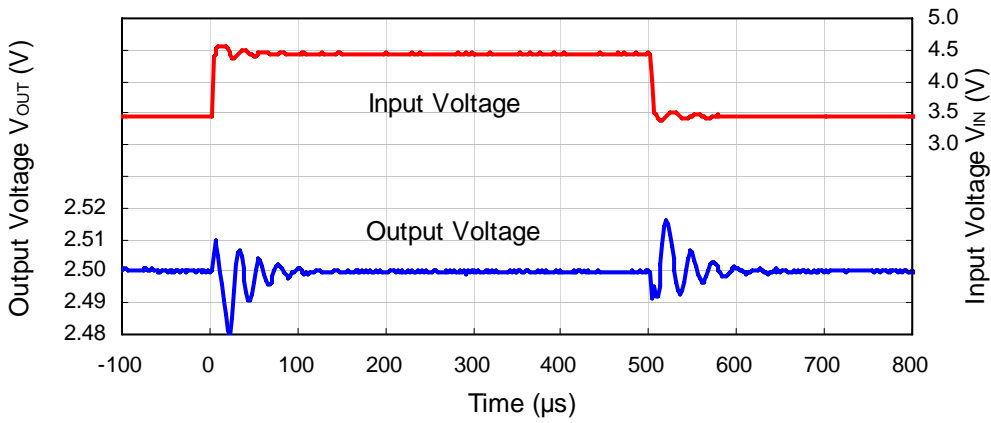

**R1510S (VR=5.0V)**

$V_{DD}=6V$  to  $7V$ ,  $C_{OUT}=6.8\mu F$ ,  $I_{OUT}=10mA(HS)$ ,  $t_f, t_r=1\mu s$

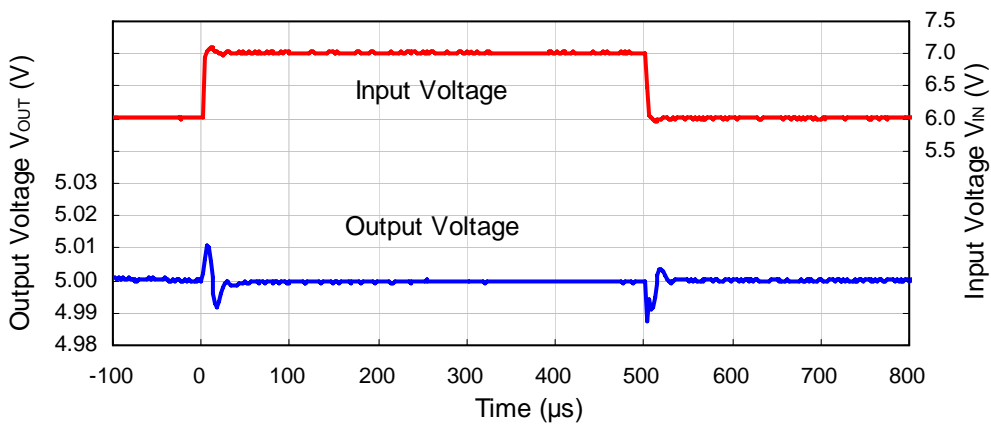

**R1510S (VR=12.0V)**

$V_{DD}=13V$  to  $14V$ ,  $C_{OUT}=6.8\mu F$ ,  $I_{OUT}=10mA$  (HS),  $t_f, t_r=1\mu s$

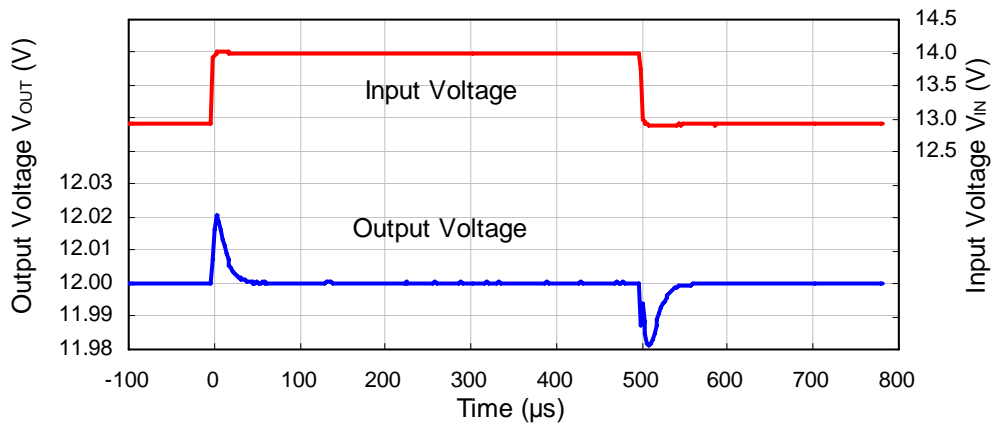

**14) Load Transient Response ( $T_a=25^\circ C$ )**

**R1510S (VR=2.5V)**

$V_{DD}=5.5V$ ,  $C_{IN}=2.2\mu F$ ,  $C_{OUT}=6.8\mu F$ ,  $I_{OUT}=0mA$  to  $300mA$ ,  $t_f, t_r=1\mu s$

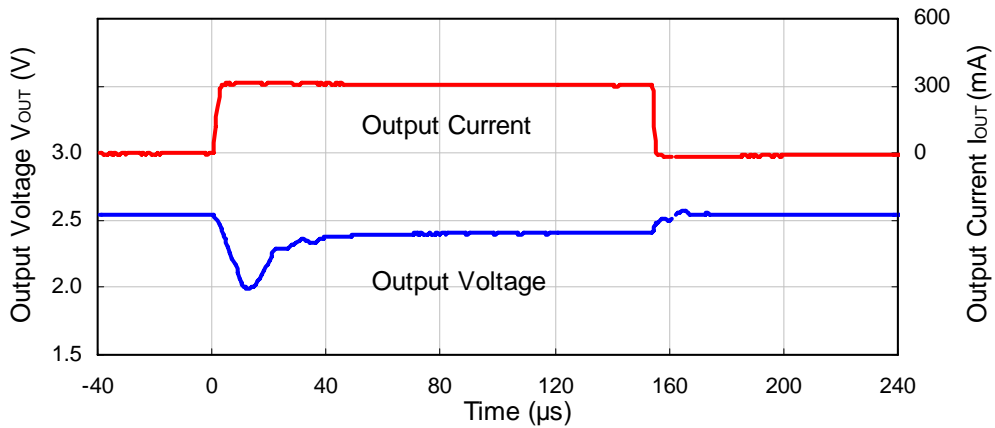

**R1510S (VR=5.0V)**

$V_{DD}=7.0V$ ,  $C_{IN}=2.2\mu F$ ,  $C_{OUT}=6.8\mu F$ ,  $I_{OUT}=0mA$  to  $300mA$ ,  $t_f, t_r=1\mu s$

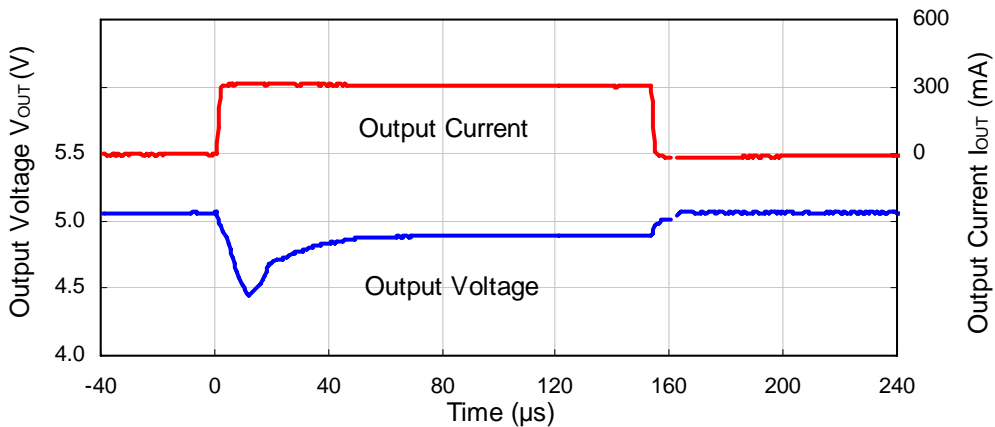

**R1510S**

NO.EA-185-140724

**R1510S (VR=12.0V)**

$V_{DD}=14V$ ,  $C_{IN}=2.2\mu F$ ,  $C_{OUT}=6.8\mu F$ ,  $I_{OUT}=0mA$  to  $300mA$ ,  $t_f, t_r=1\mu s$

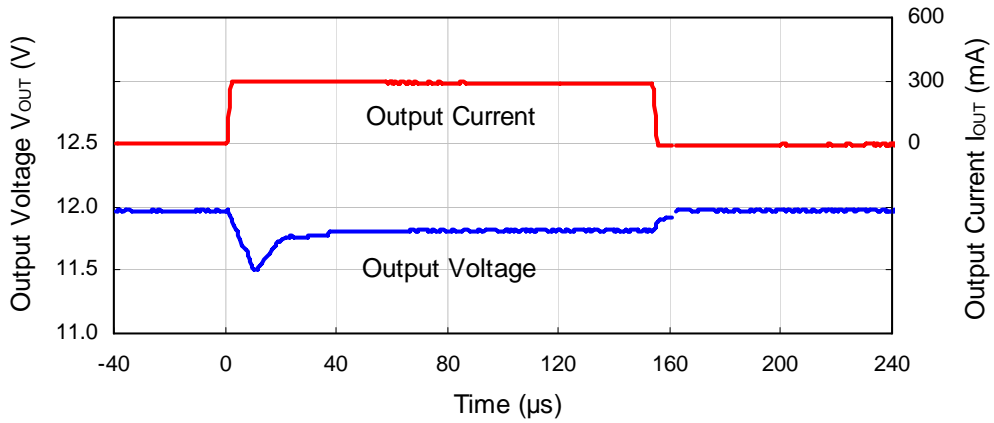

**R1510S (VR=2.5V)**

$V_{DD}=5.5V$ ,  $C_{IN}=2.2\mu F$ ,  $C_{OUT}=6.8\mu F$ ,  $I_{OUT}=20mA$  to  $300mA$ ,  $t_f, t_r=1\mu s$

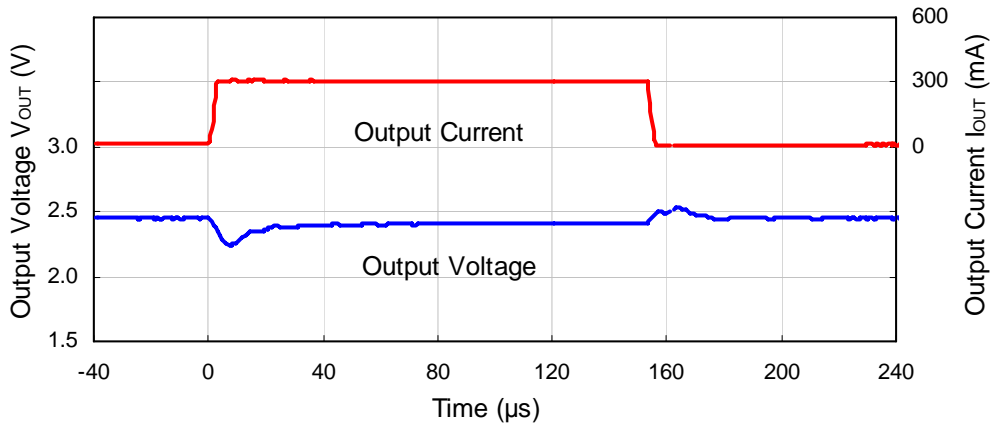

**R1510S (VR=5.0V)**

$V_{DD}=7V$ ,  $C_{IN}=2.2\mu F$ ,  $C_{OUT}=6.8\mu F$ ,  $I_{OUT}=20mA$  to  $300mA$ ,  $t_f, t_r=1\mu s$

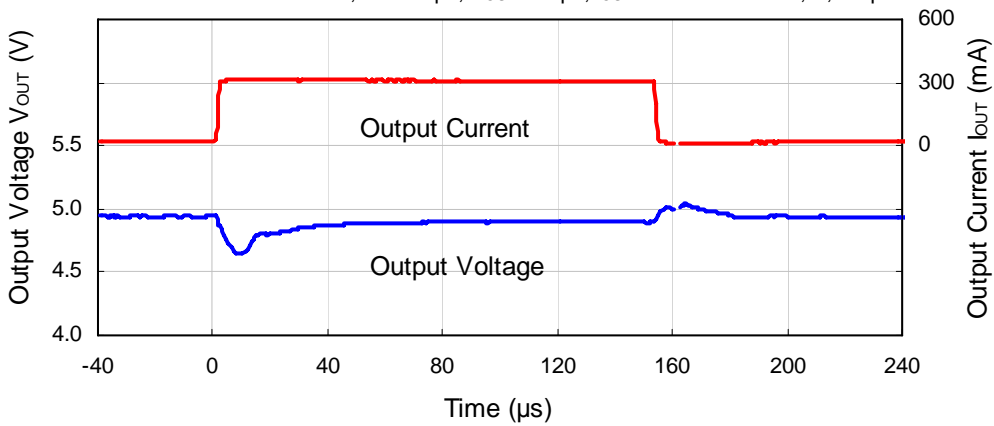



**R1510S (VR=12.0V)**

$V_{DD}=14V$ ,  $C_{IN}=2.2\mu F$ ,  $C_{OUT}=6.8\mu F$ ,  $I_{OUT}=20mA$  to  $300mA$ ,  $t_f, t_r=1\mu s$

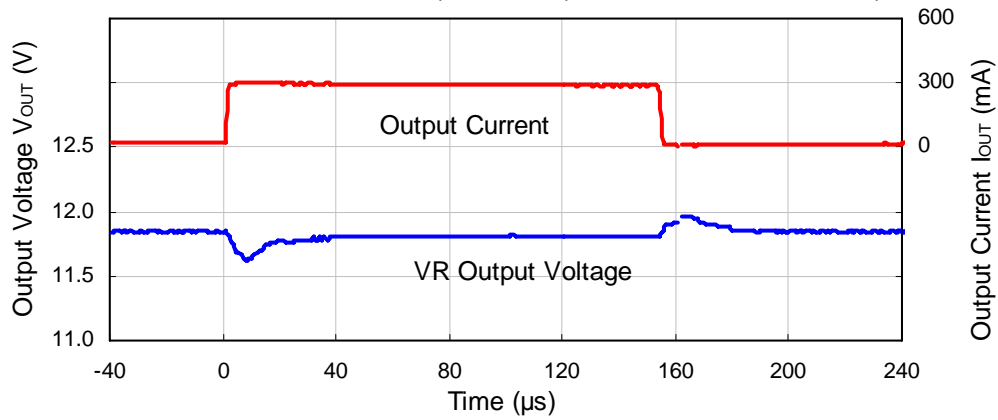

**15) Start-up Waveform (Ta=25°C)**

**R1510SxxxB/C/D (VR=5.0V)**

$C_{OUT}=6.8\mu F$ ,  $I_{OUT}=10mA$ ,  $t_f, t_r=1\mu s$

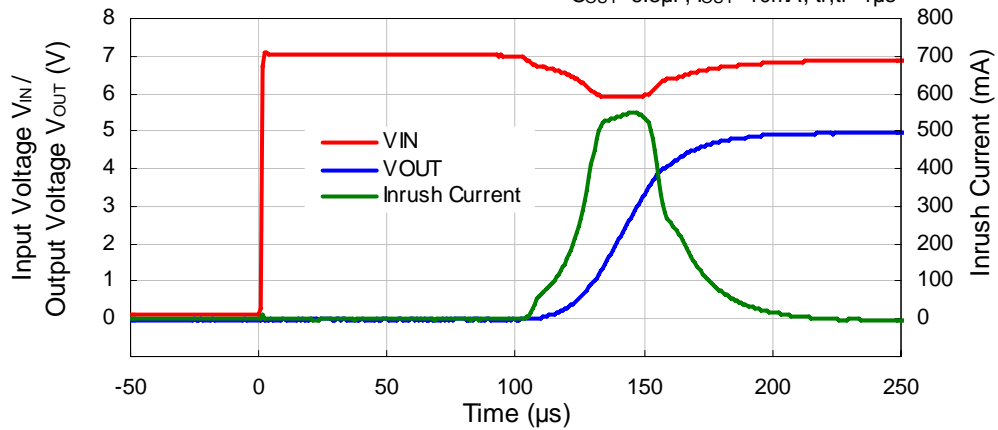

**16) Start-up Waveform by CE (Ta=25°C)**

**R1510SxxxA (VR=5.0V)**

$V_{IN}=7V$ ,  $I_{OUT}=10mA$

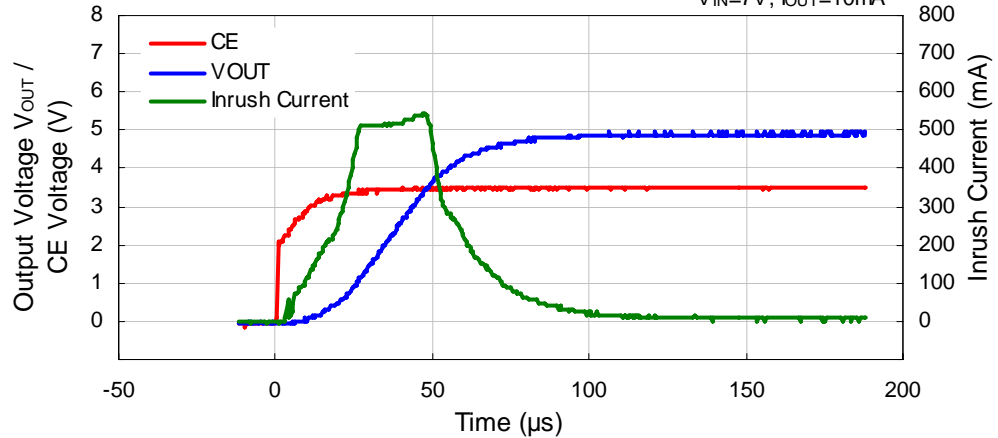

# R1510S

NO.EA-185-140724

## 17) Thermal Shutdown

### R1510S (VR=5.0V)

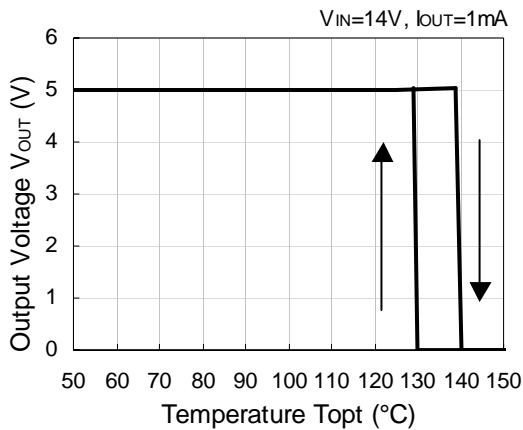

## 18) Detector Threshold Voltage vs. Operating Temperature

### R1510S (VD=2.3V)

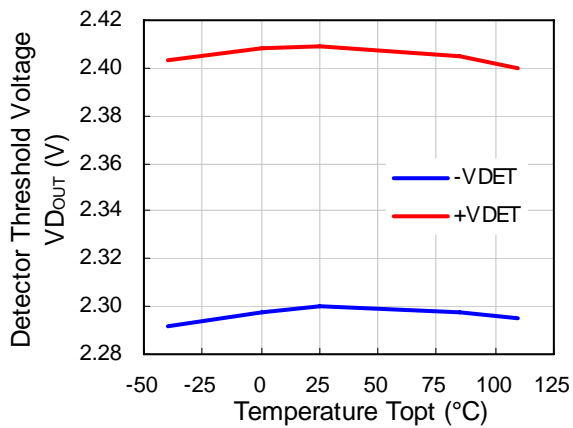

### R1510S (VD=4.8V)

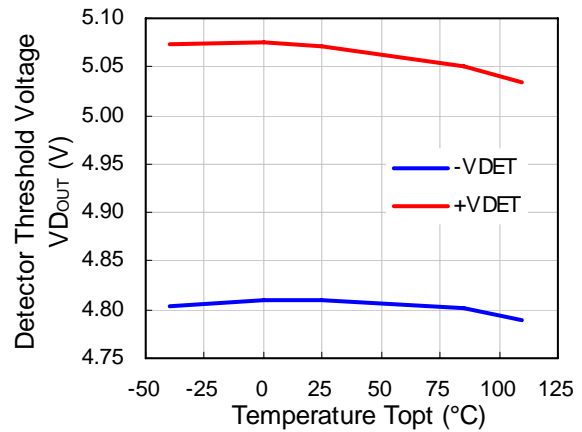

### R1510S (VD=12.0V)

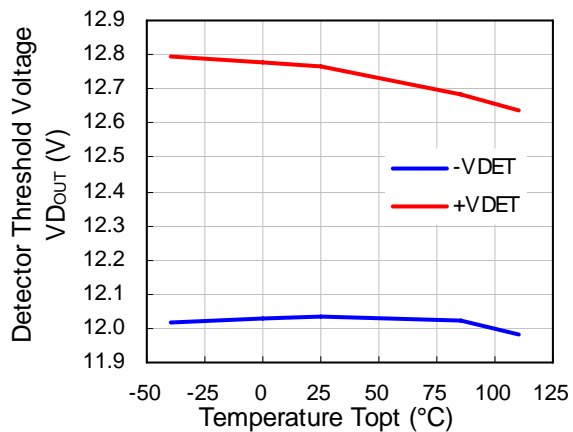

19) VD Output Voltage vs. Input Voltage

R1510SxxxA/C/D (VD=2.3V)

pull up 5V, 470kΩ

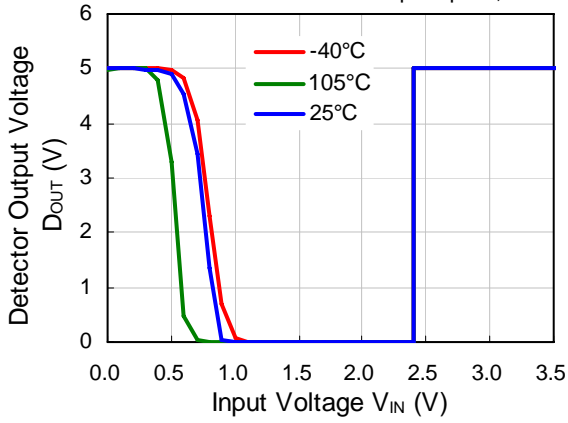

R1510SxxxA/C/D (VD=4.8V)

pull up 5V, 470kΩ

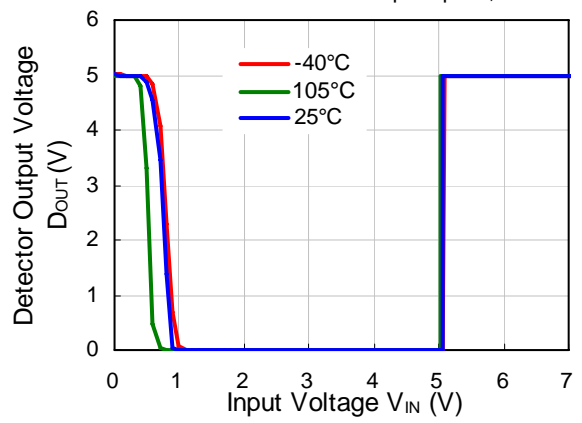

R1510SxxxA/C/D (VD=12.0V)

pull up 5V, 470kΩ

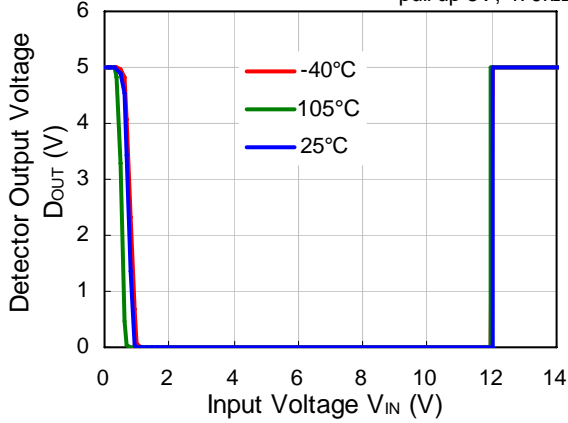

R1510SxxxB

SENSE=0V, pull up 5V, 470kΩ

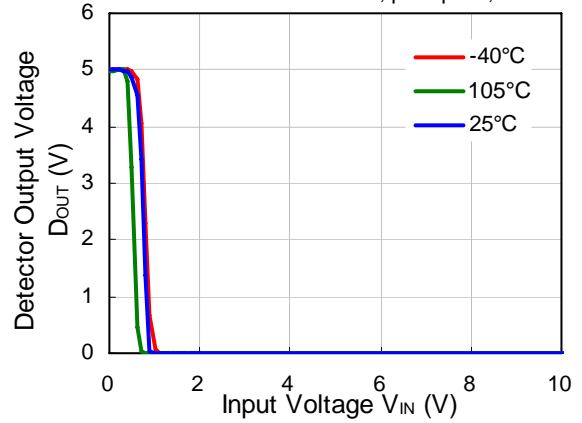

20) DOUT Sink Current vs. DOUT Output Voltage

R1510S

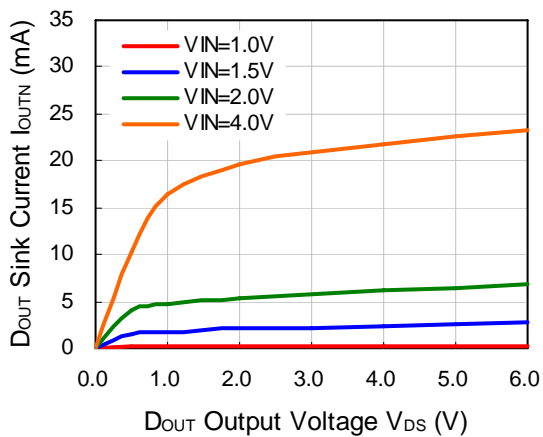

**21) D<sub>OUT</sub> Sink Current vs. Input Voltage**

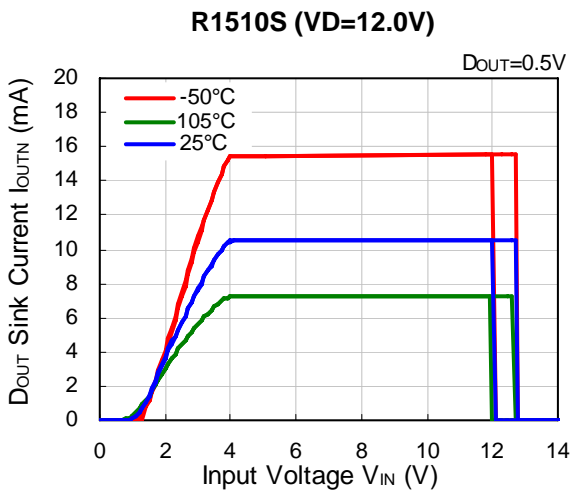
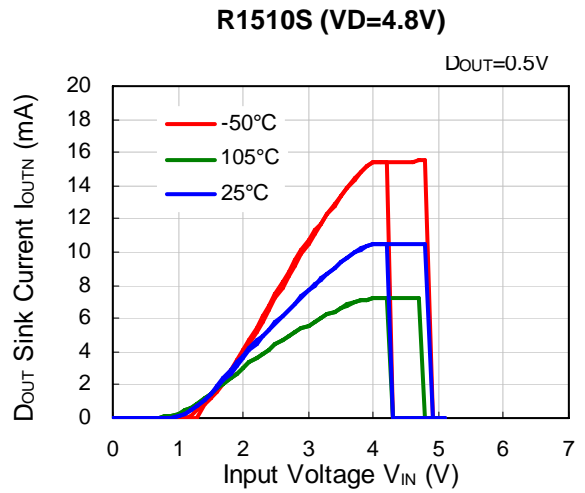
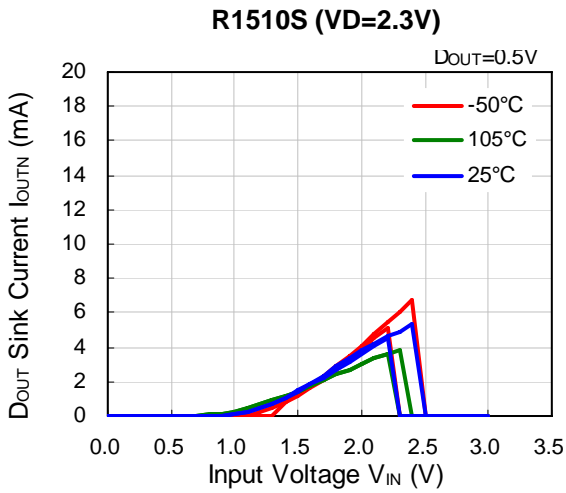

**22) C<sub>D</sub> Detector Threshold vs. Operating Voltage**

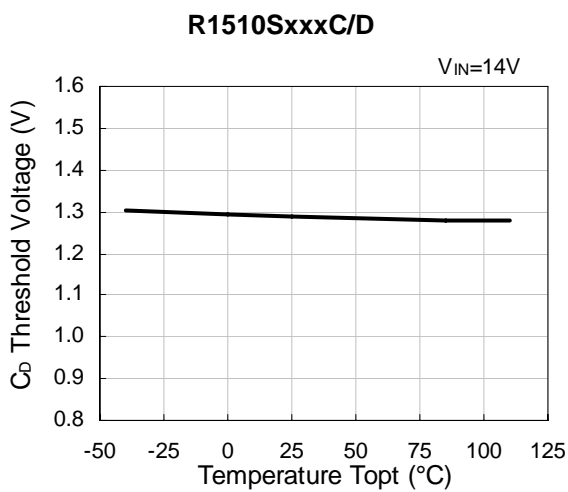

**23) C<sub>D</sub> Sink Current vs. C<sub>D</sub> Output Voltage**

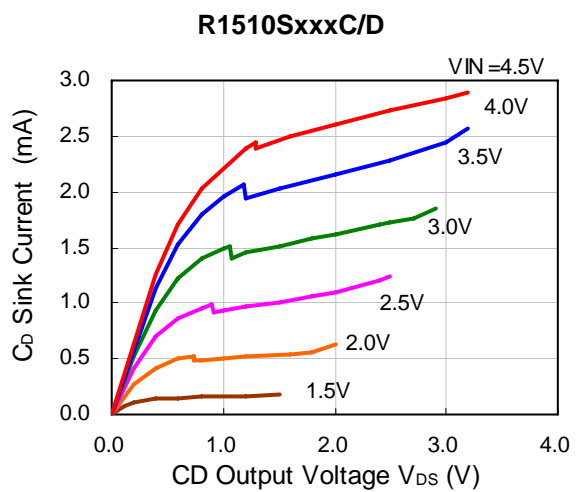

24) C<sub>D</sub> Output Current Vs. Input Voltage

R1510SxxxC/D (VD=2.3V)

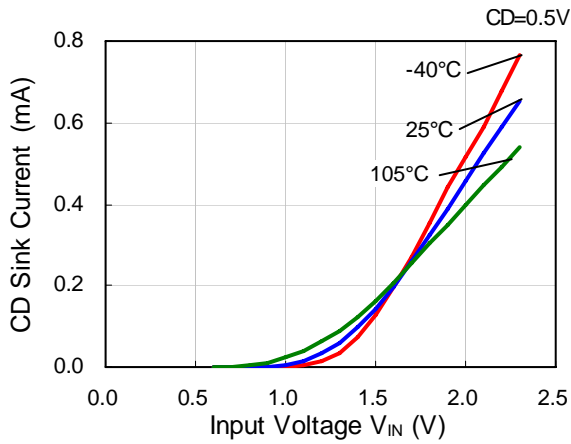

R1510SxxxC/D (VD=4.8V)

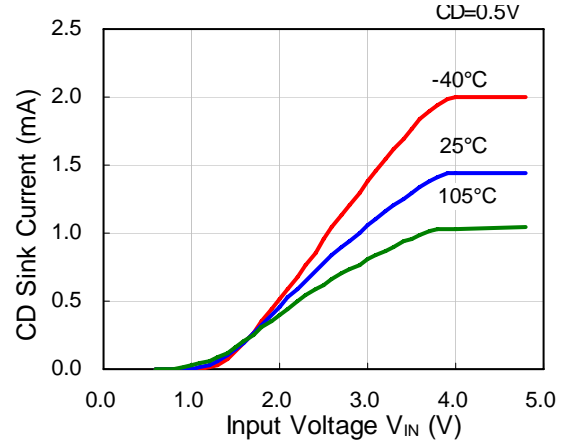

R1510SxxxC/D (VD=12.0V)

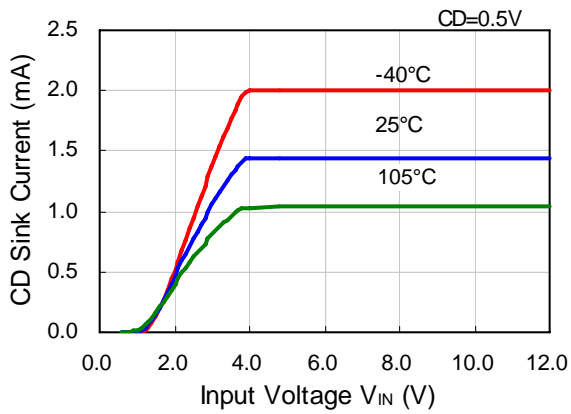

25) Output Delay Time vs. Operating Temperature

R1510SxxxA/B

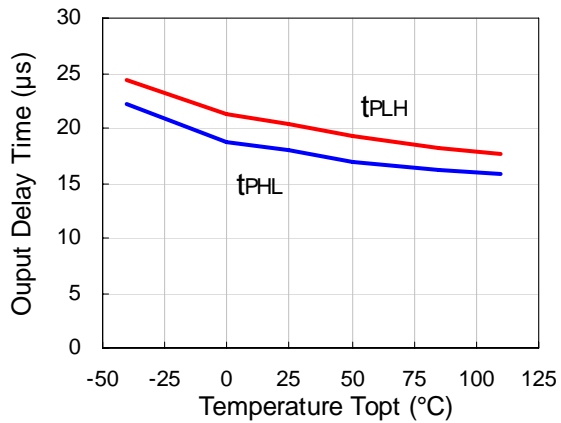

26) Release Output Delay Time vs. Operating Temperature

R1510SxxxC/D

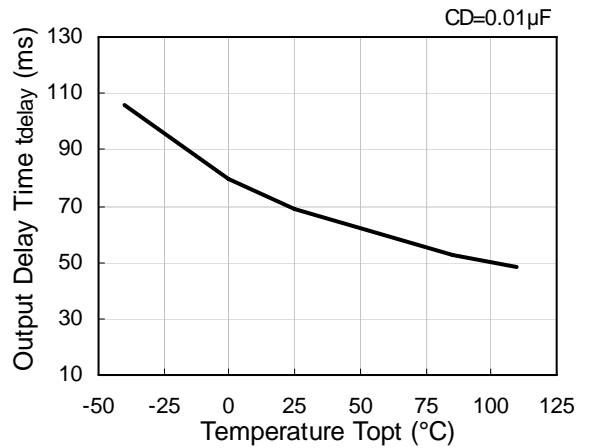

27) Output Delay Time vs. External Capacitance of Output Delay Pin

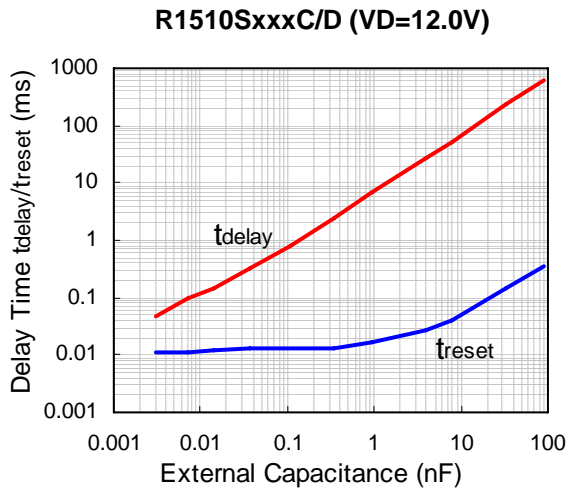
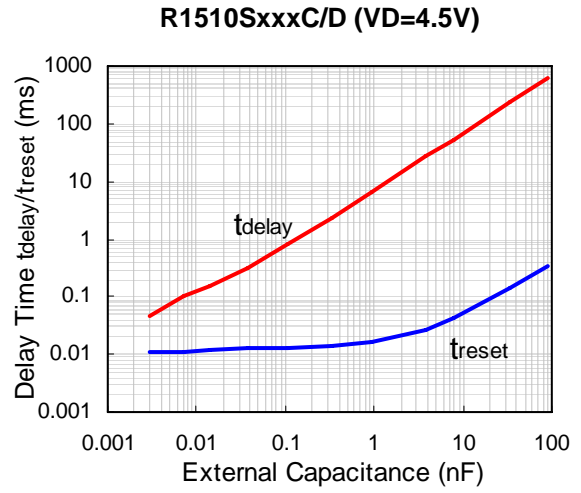
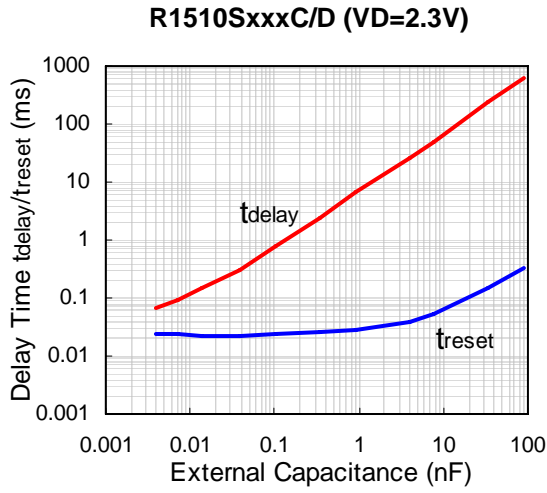

**Detection Operation Glitch of SENSE Pin Voltage**

The graph below shows that the pulse amplitude/ pulse width that can maintain the released condition when the pulse of less than the detector threshold voltage was input into SENSE pin.

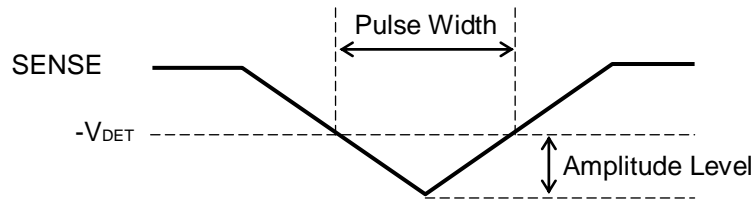
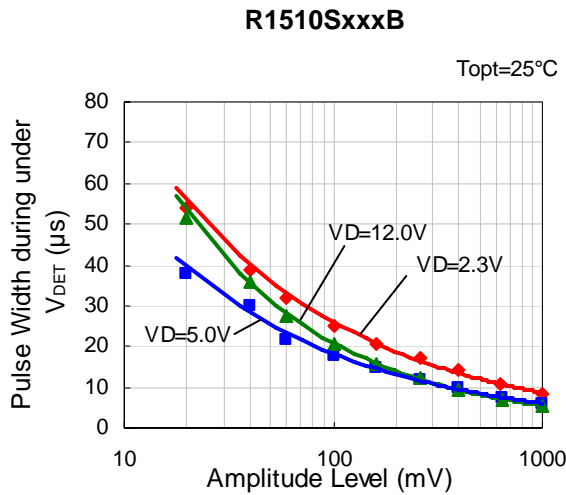

**SENSE Input Waveform**

This graph shows the maximum pulse conditions that can maintain the released condition. Please be careful to the sizes of the pulse width and the pulse amplitude going into SENSE pin because if they are bigger than the sizes of the pulse width and the pulse amplitude in this graph, the reset signal may go off.

### EQUIVALENT SERIES RESISTANCE vs. OUTPUT CURRENT

Ceramic type output capacitor is recommended for this series, however; low ESR type capacitor also could be used. For reference, the conditions below show the relationship between the output current ( $I_{OUT}$ ) of which noise level is 40 $\mu$ V (average) or less and the ESR.

Measurement Conditions

- Noise Frequency Range: 10Hz to 2MHz
- Ambient Temperature: -40°C to 105°C
- Shaded Area: Noise level is 40 $\mu$ V (average) or less
- Output Capacitor: Ceramic 6.8 $\mu$ F

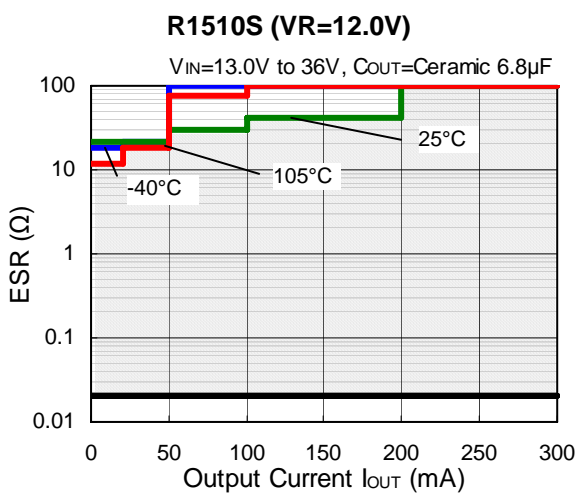
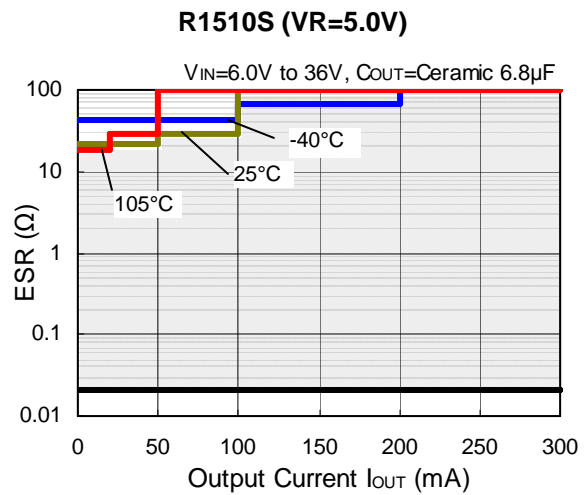
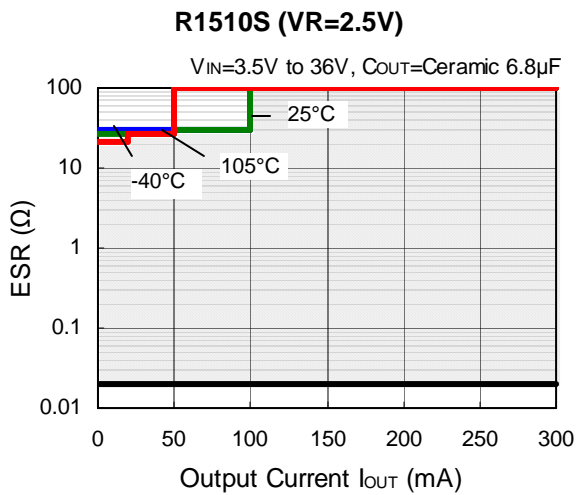





1. The products and the product specifications described in this document are subject to change or discontinuation of production without notice for reasons such as improvement. Therefore, before deciding to use the products, please refer to Ricoh sales representatives for the latest information thereon.
2. The materials in this document may not be copied or otherwise reproduced in whole or in part without prior written consent of Ricoh.
3. Please be sure to take any necessary formalities under relevant laws or regulations before exporting or otherwise taking out of your country the products or the technical information described herein.
4. The technical information described in this document shows typical characteristics of and example application circuits for the products. The release of such information is not to be construed as a warranty of or a grant of license under Ricoh's or any third party's intellectual property rights or any other rights.
5. The products listed in this document are intended and designed for use as general electronic components in standard applications (office equipment, telecommunication equipment, measuring instruments, consumer electronic products, amusement equipment etc.). Those customers intending to use a product in an application requiring extreme quality and reliability, for example, in a highly specific application where the failure or misoperation of the product could result in human injury or death (aircraft, spacevehicle, nuclear reactor control system, traffic control system, automotive and transportation equipment, combustion equipment, safety devices, life support system etc.) should first contact us.
6. We are making our continuous effort to improve the quality and reliability of our products, but semiconductor products are likely to fail with certain probability. In order to prevent any injury to persons or damages to property resulting from such failure, customers should be careful enough to incorporate safety measures in their design, such as redundancy feature, fire containment feature and fail-safe feature. We do not assume any liability or responsibility for any loss or damage arising from misuse or inappropriate use of the products.
7. Anti-radiation design is not implemented in the products described in this document.
8. The X-ray exposure can influence functions and characteristics of the products. Confirm the product functions and characteristics in the evaluation stage.
9. WLCSP products should be used in light shielded environments. The light exposure can influence functions and characteristics of the products under operation or storage.
10. There can be variation in the marking when different AOI (Automated Optical Inspection) equipment is used. In the case of recognizing the marking characteristic with AOI, please contact Ricoh sales or our distributor before attempting to use AOI.
11. Please contact Ricoh sales representatives should you have any questions or comments concerning the products or the technical information.



**Ricoh is committed to reducing the environmental loading materials in electrical devices with a view to contributing to the protection of human health and the environment.**

Ricoh has been providing RoHS compliant products since April 1, 2006 and Halogen-free products since April 1, 2012.

**RICOH** RICOH ELECTRONIC DEVICES CO., LTD.

<https://www.e-devices.ricoh.co.jp/en/>

#### Sales & Support Offices

##### **Ricoh Electronic Devices Co., Ltd.**

##### **Shin-Yokohama Office (International Sales)**

2-3, Shin-Yokohama 3-chome, Kohoku-ku, Yokohama-shi, Kanagawa, 222-8530, Japan  
Phone: +81-50-3814-7687 Fax: +81-45-474-0074

##### **Ricoh Americas Holdings, Inc.**

675 Campbell Technology Parkway, Suite 200 Campbell, CA 95008, U.S.A.  
Phone: +1-408-610-3105

##### **Ricoh Europe (Netherlands) B.V.**

##### **Semiconductor Support Centre**

Prof. W.H. Keesomlaan 1, 1183 DJ Amstelveen, The Netherlands  
Phone: +31-20-5474-309

##### **Ricoh International B.V. - German Branch**

##### **Semiconductor Sales and Support Centre**

Oberrather Strasse 6, 40472 Düsseldorf, Germany  
Phone: +49-211-6546-0

##### **Ricoh Electronic Devices Korea Co., Ltd.**

3F, Haesung Bldg, 504, Teheran-ro, Gangnam-gu, Seoul, 135-725, Korea  
Phone: +82-2-2135-5700 Fax: +82-2-2051-5713

##### **Ricoh Electronic Devices Shanghai Co., Ltd.**

Room 403, No.2 Building, No.690 Bibo Road, Pu Dong New District, Shanghai 201203,  
People's Republic of China  
Phone: +86-21-5027-3200 Fax: +86-21-5027-3299

##### **Ricoh Electronic Devices Shanghai Co., Ltd.**

##### **Shenzhen Branch**

1205, Block D (Jinlong Building), Kingkey 100, Hongbao Road, Luohu District,  
Shenzhen, China  
Phone: +86-755-8348-7600 Ext 225

##### **Ricoh Electronic Devices Co., Ltd.**

##### **Taipei office**

Room 109, 10F-1, No.51, Hengyang Rd., Taipei City, Taiwan (R.O.C.)  
Phone: +886-2-2313-1621/1622 Fax: +886-2-2313-1623

# Mouser Electronics

Authorized Distributor

Click to View Pricing, Inventory, Delivery & Lifecycle Information:

## Ricoh Electronics:

[R1510S001B-E2-FE](#) [R1510S001A-E2-FE](#) [R1510S001C-E2-FE](#) [R1510S001D-E2-FE](#) [R1510S002A-E2-FE](#)  
[R1510S002B-E2-FE](#) [R1510S002C-E2-FE](#) [R1510S011D-E2-FE](#) [R1510S012A-E2-FE](#) [R1510S012B-E2-FE](#)  
[R1510S012C-E2-FE](#) [R1510S012D-E2-FE](#) [R1510S010A-E2-FE](#) [R1510S010B-E2-FE](#) [R1510S010C-E2-FE](#)  
[R1510S011A-E2-FE](#) [R1510S011B-E2-FE](#) [R1510S011C-E2-FE](#) [R1510S008C-E2-FE](#) [R1510S008D-E2-FE](#)  
[R1510S009A-E2-FE](#) [R1510S009B-E2-FE](#) [R1510S009C-E2-FE](#) [R1510S009D-E2-FE](#) [R1510S006C-E2-FE](#)  
[R1510S007A-E2-FE](#) [R1510S007B-E2-FE](#) [R1510S007C-E2-FE](#) [R1510S008A-E2-FE](#) [R1510S008B-E2-FE](#)  
[R1510S004D-E2-FE](#) [R1510S005A-E2-FE](#) [R1510S005B-E2-FE](#) [R1510S005C-E2-FE](#) [R1510S006A-E2-FE](#)  
[R1510S006B-E2-FE](#) [R1510S003A-E2-FE](#) [R1510S003B-E2-FE](#) [R1510S003C-E2-FE](#) [R1510S003D-E2-FE](#)  
[R1510S004B-E2-FE](#) [R1510S004C-E2-FE](#)

Компания «Океан Электроники» предлагает заключение долгосрочных отношений при поставках импортных электронных компонентов на взаимовыгодных условиях!

Наши преимущества:

- Поставка оригинальных импортных электронных компонентов напрямую с производств Америки, Европы и Азии, а так же с крупнейших складов мира;
- Широкая линейка поставок активных и пассивных импортных электронных компонентов (более 30 млн. наименований);
- Поставка сложных, дефицитных, либо снятых с производства позиций;
- Оперативные сроки поставки под заказ (от 5 рабочих дней);
- Экспресс доставка в любую точку России;
- Помощь Конструкторского Отдела и консультации квалифицированных инженеров;
- Техническая поддержка проекта, помощь в подборе аналогов, поставка прототипов;
- Поставка электронных компонентов под контролем ВП;
- Система менеджмента качества сертифицирована по Международному стандарту ISO 9001;
- При необходимости вся продукция военного и аэрокосмического назначения проходит испытания и сертификацию в лаборатории (по согласованию с заказчиком);
- Поставка специализированных компонентов военного и аэрокосмического уровня качества (Xilinx, Altera, Analog Devices, Intersil, Interpoint, Microsemi, Actel, Aeroflex, Peregrine, VPT, Syfer, Eurofarad, Texas Instruments, MS Kennedy, Miteq, Cobham, E2V, MA-COM, Hittite, Mini-Circuits, General Dynamics и др.);

Компания «Океан Электроники» является официальным дистрибьютором и эксклюзивным представителем в России одного из крупнейших производителей разъемов военного и аэрокосмического назначения «JONHON», а так же официальным дистрибьютором и эксклюзивным представителем в России производителя высокотехнологичных и надежных решений для передачи СВЧ сигналов «FORSTAR».



## JONHON

«JONHON» (основан в 1970 г.)

Разъемы специального, военного и аэрокосмического назначения:

(Применяются в военной, авиационной, аэрокосмической, морской, железнодорожной, горно- и нефтедобывающей отраслях промышленности)

«FORSTAR» (основан в 1998 г.)

ВЧ соединители, коаксиальные кабели, кабельные сборки и микроволновые компоненты:

(Применяются в телекоммуникациях гражданского и специального назначения, в средствах связи, РЛС, а так же военной, авиационной и аэрокосмической отраслях промышленности).



Телефон: 8 (812) 309-75-97 (многоканальный)

Факс: 8 (812) 320-03-32

Электронная почта: [ocean@oceanchips.ru](mailto:ocean@oceanchips.ru)

Web: <http://oceanchips.ru/>

Адрес: 198099, г. Санкт-Петербург, ул. Калинина, д. 2, корп. 4, лит. А