

Temperature Controller E5C2

CSM_E5C2_DS_E_4_1

DIN-sized (48 x 48 mm) Temperature Controller with Analog Setting

- Compact, low-cost Temperature Controller.
- Incorporates proportional control and reset adjustment function.
- Consecutive mounting possible using mounting adapter.
- Incorporates a plug-in socket, thus allows to DIN-track and flush mounting.

⚠ Refer to *Safety Precautions for All Temperature Controllers*.



Model Number Structure

Model Number Legend

E5C2- □ □ □ □
1 2 3 4 5

1. Control Outputs

R: Relay

2. Control Method

20: ON-OFF control

40: Proportional control

3. Input

K: K-type thermocouple

J: J-type thermocouple

P-D: Platinum resistance thermometer (Pt100)

G: Thermistor with replaceable element

Note: A functional explanation is provided here for illustration, but models are not necessarily available for all possible combinations. Refer to *Ordering Information* when ordering.

Examples

- Relay control output, ON/OFF control, type-K thermocouple input: E5C2-R20K
- Relay control output, proportional control, thermocouple input: E5C2-R40P-D

Ordering Information

Temperature Controllers

Setting method	Indication method	Control mode	Output	Minimum scale division (°C)	Input																													
					Thermocouple			Resistance Thermometer			Thermistor																							
					K (CA) Chromel vs. alumel			J (IC) Iron vs. constantan			Platinum resistance thermometer Pt100			Thermistor (replaceable element)																				
				Standard scale (°C)	1,200	1,000	800	600	400	300	200	1,200	1,000	800	600	400	300	200	150	100	50	50	100	150	200	300	400	500	600	800	1,000	1,200		
					5	10	10	20	20	25	25	5	10	10	2	2	1	2	5	10	10	2	2	2	2	2	2	2	2	2	2	2	2	2
Analog setting	No indication	ON/OFF	Relay	Model	E5C2-R20K			E5C2-R20J			E5C2-R20P-D			E5C2-R20G																				
		Proportional (P)	Relay	Model	E5C2-R40K			E5C2-R40J			E5C2-R40P-D			---																				

Note: When placing an order, specify the temperature range and supply voltage in addition to the model number.

Standard Models (Power Supply: 100 to 120 VAC)

		Indication method		No indication	
				ON/OFF	Proportional (P)
Control mode		Relay			
Input	Output				
Input/standard scale (°C)	Thermocouple K (CA) Chromel vs. alumel	0 to 200	E5C2-R20K	E5C2-R40K	
		0 to 300	E5C2-R20K	E5C2-R40K	
		0 to 400	E5C2-R20K	E5C2-R40K	
		0 to 600	E5C2-R20K	E5C2-R40K	
		0 to 800	E5C2-R20K	E5C2-R40K	
		0 to 1,000	E5C2-R20K	E5C2-R40K	
		0 to 1,200	E5C2-R20K	E5C2-R40K	
		J (IC) Iron vs. constantan	0 to 200	E5C2-R20J	E5C2-R40J
	0 to 300	E5C2-R20J	E5C2-R40J		
	0 to 400	E5C2-R20J	E5C2-R40J		

Note: Ask your OMRON representative about models with 200 to 240 VAC power supply.

		Indication method		No indication	
				ON/OFF	Proportional (P)
Control mode		Relay			
Input	Output				
Input/standard scale (°C)	Resistance Thermometer	Platinum resistance thermometer Pt100	-50 to 50	E5C2-R20P-D	E5C2-R40P-D
		-20 to 80	E5C2-R20P-D	E5C2-R40P-D	
		0 to 50	E5C2-R20P-D	E5C2-R40P-D	
		0 to 100	E5C2-R20P-D	E5C2-R40P-D	
		0 to 200	E5C2-R20P-D	E5C2-R40P-D	
		0 to 300	E5C2-R20P-D	E5C2-R40P-D	
		0 to 400	E5C2-R20P-D	E5C2-R40P-D	
		Thermistor	THE (replaceable element)	-50 to 50	E5C2-R20G
	0 to 100	E5C2-R20G	---		
	50 to 150	E5C2-R20G	---		
	100 to 200	E5C2-R20G	---		
	150 to 300	E5C2-R20G	---		

Accessories (Order Separately)

Sockets

Name	Model
Front Connecting Socket	P2CF-08
Back Connecting Socket	P3G-08
Front Connecting Socket with Finger Protection	P2CF-08-E
Protective Cover (for finger protection)	Y92A-48G

Protective Cover

Type	Model
Hard Protective Cover	Y92A-48B

Specifications

Ratings

Supply voltage	100 to 120 VAC 50/60 Hz 200 to 240 VAC 50/60 Hz (See note 1.)
Operating voltage range	90% to 110% of rated supply voltage
Power consumption	Approx. 3 VA
Input	Thermocouple (with sensor burnout detection circuit), platinum resistance thermometer, or thermistor with replaceable element
Control method	ON/OFF or proportional control
Setting method	Analog setting
Indication method	No indication
Control output	Relay output: SPDT, 3 A at 250 VAC, resistive load (switching capacity: 330 VA)
Ambient operating temperature	-10°C to 55°C (with no icing or condensation)
Ambient operating humidity	45% to 85%

- Note: 1. Specify either 100/110/120 VAC or 200/220/240 VAC when ordering.
2. Do not use an inverter output as the power supply. (Refer to Safety Precautions for All Temperature Controllers.)

Characteristics

Setting accuracy	±2% FS max.
Hysteresis	Approx. 0.5% FS (fixed)
Proportional band	3% FS (fixed)
Control period	Approx. 20 s
Reset range	5 ±1% FS min. (See note 1.)
Insulation resistance	20 MΩ min. (at 500 VDC)
Dielectric strength	2,000 VAC, 50/60 Hz for 1 min between charged terminals and uncharged metallic parts
Vibration resistance	Malfunction: 10 to 55 Hz, 0.15-mm single amplitude for 10 min each in X, Y, and Z directions Destruction: 16.7 Hz, 2-mm double amplitude for 2 hrs each in X, Y, and Z directions
Shock resistance	Malfunction: 147 m/s ² , 3 times each in 6 directions Destruction: 294 m/s ² , 3 times each in 6 directions
Life expectancy	Electrical: 100,000 operations min. (3 A at 110 VAC, resistive load)
Weight	Approx. 200 g (with flush-mounting adapter)
Degree of protection	Front panel: IEC standard IP40 (See note 2.) Terminals: IEC standard IP00
Applicable Socket	P2CF-08 (order separately), P3G-08 (order separately)
Applicable Protective Cover	Y92A-48B (order separately)

- Note: 1. No reset function is incorporated by any E5C2 model with ON/OFF control. The reset function is used to correct offset for proportional control. If there is an offset below the set value, turn the reset adjustment clockwise.
2. A special Watertight Cover is used to achieve this degree of protection (IP66, NEMA4). Refer to Y92A-□□□N.

Connections

Connecting the Input

- Connect a thermocouple, the E52-THE□ Thermistor (replaceable element) or a platinum resistance thermometer to terminals 1 (positive) and 2 (negative) on the E5C2 as shown in the following illustration.

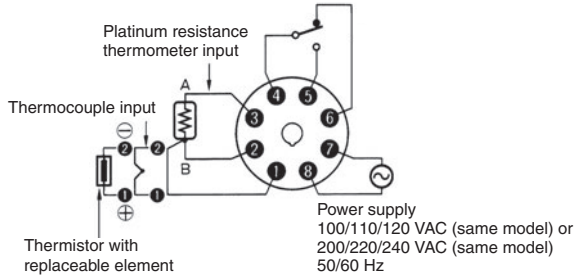

- On the E52-□□1D, the lead wires are thermocouple element wires, making them difficult to solder because solder will not stick to them easily. Remove the crimp terminal and polish the ends before attempting to solder them.

Output

- If the load circuit is a heating control system, be sure to connect the load to terminals 4 and 5. If the load circuit is a cooling control system, be sure to connect the load to terminals 4 and 6.
- We recommend using an external relay to extend the electrical life of internal relays when driving a large capacity load. This is particularly important when the output relay is switched frequently (e.g., with proportional control).

Power Supply

- If a single power supply is used for the E5C2 and the load, the supply voltage of the power supply may vary greatly when the load is open or closed if the capacity of the power supply is not large enough. Make sure that the capacity of the power supply is large enough so that the supply voltage range will be always from 90% to 110% of the rated supply voltage.
- The E5C2 operates at either 50 or 60 Hz.
- Different models must be order for 100 to 120 VAC and 200 to 240 VAC.

Nomenclature

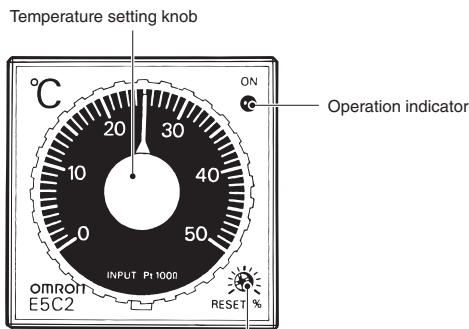

RESET adjustment shaft
No reset function is incorporated by any E5C2 model with ON/OFF control.

Operation Indicator

Indicator	Output	
	NO contacts (4 and 5)	NC contacts (4 to 6)
Red Lit	ON	OFF
Not lit	OFF	ON

Dimensions

Note: All units are in millimeters unless otherwise indicated.

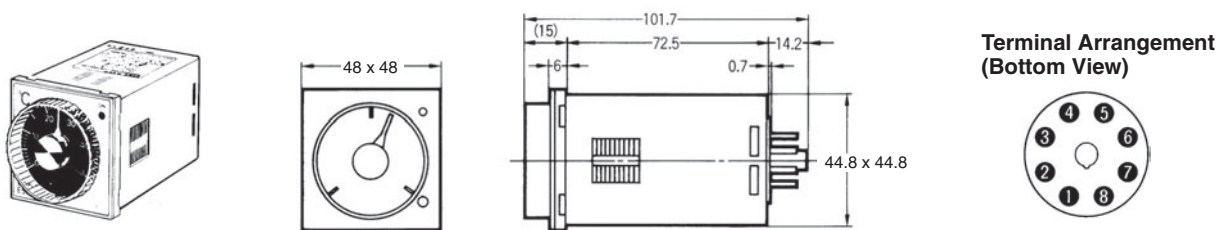

Dimensions with Flush-mounting Adapter (Accessory), and Back Connecting Socket (Sold Separately)

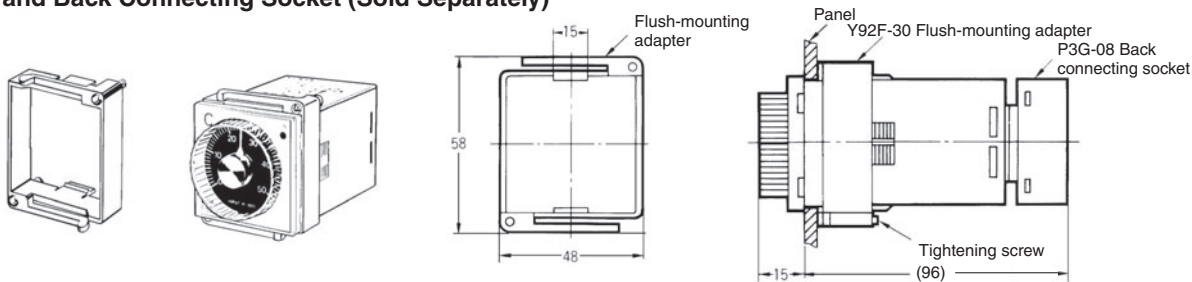

Panel Cutout

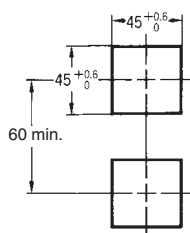

Side-by-side Mounting of N Controllers

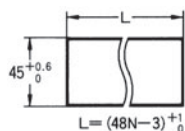

Qty.	2	3	4	5	6
L	93 ⁺¹ ₀	141 ⁺¹ ₀	189 ⁺¹ ₀	237 ⁺¹ ₀	285 ⁺¹ ₀

- Note: 1. Recommended panel thickness is 1 to 4 mm.
- 2. Close side-by-side mounting is possible (in a single direction).

Accessories (Order Separately)

Connection Sockets

P2CF-08 Front Connecting Socket

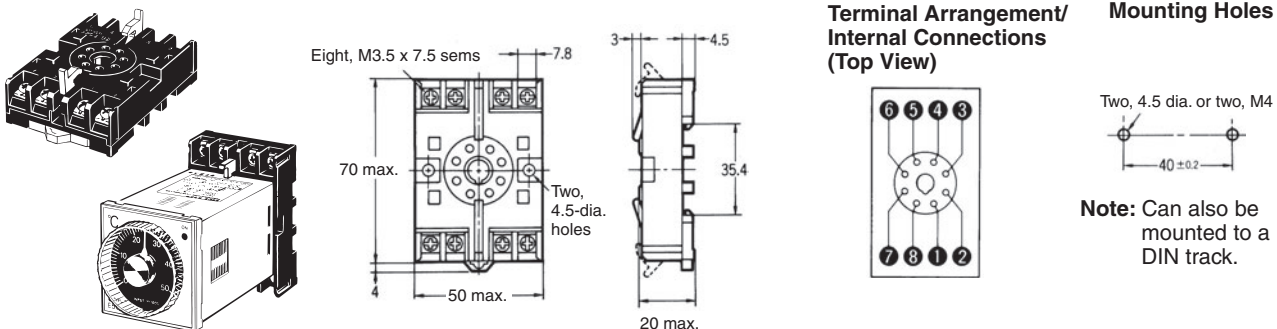

Note: A finger-protection model (P2CF-08-E) is also available.

P3G-08 Back Connecting Socket (for Flush Mounting)

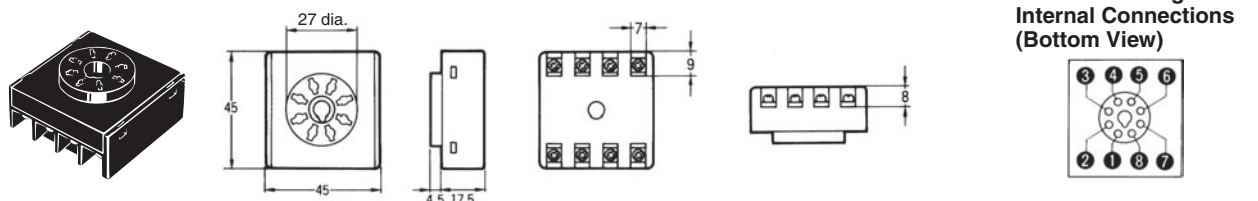

Note: A Protective Cover for finger protection (Y92A-48G) is also available.

Hard Protective Cover

A Hard Protective Cover (Y92A-48B) is available. It can be used in the following cases.

- To protect the setting section, against dust and dirt
- To prevent accidentally changing settings by touching the front of the Controller.
- To protect the Controller from water drips

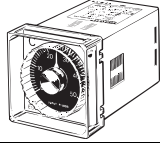
Appearance	
Model	Y92A-48B

Applicable Thermistor

Connect a Thermistor with a replaceable element (E52-THE5A, E52-THE6D, or E52-THE6F) to the E5C2-R20G. Refer to E52 for details.

Safety Precautions

Refer to *Safety Precautions for All Temperature Controllers*.

Correct Use

Mounting

Track Mounting (E5C2 with P2CF-08)

When mounting two or more E5C2 models with track-mounting sockets, leave a space of approximately 20 mm on both sides of the sockets where hooks are located.

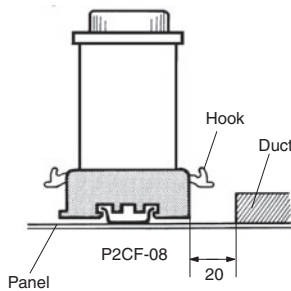

Flush Mounting

Insert E5C2 into the square hole of the panel and insert an adapter from the back so that there will be no space between E5C2 and the panel. Then, secure the E5C2 with a screw.

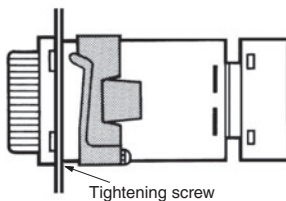

The P3G-08 can be wired in the same way as the P2CF-08.

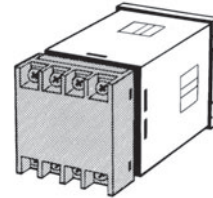

Dismounting

If flush mounted, loosen the screw of the adapter and disengage the hooks for dismounting.

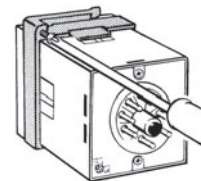

Temperature Setting

Do not turn the temperature setting knob of the E5C2 with excessive force, otherwise the stopper of the knob may break.

Others

- Do not remove the housing of the E5C2, otherwise the housing may break.
- To clean the surface of the E5C2, use a soft cloth wet with neutral detergent or alcohol. Do not use any organic solvent, such as paint thinner or benzene, strong acid or strong alkali to clean the surface of the E5C2, otherwise the surface of the E5C2 will become damaged.

ALL DIMENSIONS SHOWN ARE IN MILLIMETERS.

To convert millimeters into inches, multiply by 0.03937. To convert grams into ounces, multiply by 0.03527.

In the interest of product improvement, specifications are subject to change without notice.

Read and Understand This Catalog

Please read and understand this catalog before purchasing the products. Please consult your OMRON representative if you have any questions or comments.

Warranty and Limitations of Liability

WARRANTY

OMRON's exclusive warranty is that the products are free from defects in materials and workmanship for a period of one year (or other period if specified) from date of sale by OMRON.

OMRON MAKES NO WARRANTY OR REPRESENTATION, EXPRESS OR IMPLIED, REGARDING NON-INFRINGEMENT, MERCHANTABILITY, OR FITNESS FOR PARTICULAR PURPOSE OF THE PRODUCTS. ANY BUYER OR USER ACKNOWLEDGES THAT THE BUYER OR USER ALONE HAS DETERMINED THAT THE PRODUCTS WILL SUITABLY MEET THE REQUIREMENTS OF THEIR INTENDED USE. OMRON DISCLAIMS ALL OTHER WARRANTIES, EXPRESS OR IMPLIED.

LIMITATIONS OF LIABILITY

OMRON SHALL NOT BE RESPONSIBLE FOR SPECIAL, INDIRECT, OR CONSEQUENTIAL DAMAGES, LOSS OF PROFITS OR COMMERCIAL LOSS IN ANY WAY CONNECTED WITH THE PRODUCTS, WHETHER SUCH CLAIM IS BASED ON CONTRACT, WARRANTY, NEGLIGENCE, OR STRICT LIABILITY.

In no event shall the responsibility of OMRON for any act exceed the individual price of the product on which liability is asserted.

IN NO EVENT SHALL OMRON BE RESPONSIBLE FOR WARRANTY, REPAIR, OR OTHER CLAIMS REGARDING THE PRODUCTS UNLESS OMRON'S ANALYSIS CONFIRMS THAT THE PRODUCTS WERE PROPERLY HANDLED, STORED, INSTALLED, AND MAINTAINED AND NOT SUBJECT TO CONTAMINATION, ABUSE, MISUSE, OR INAPPROPRIATE MODIFICATION OR REPAIR.

Application Considerations

SUITABILITY FOR USE

OMRON shall not be responsible for conformity with any standards, codes, or regulations that apply to the combination of products in the customer's application or use of the products.

At the customer's request, OMRON will provide applicable third party certification documents identifying ratings and limitations of use that apply to the products. This information by itself is not sufficient for a complete determination of the suitability of the products in combination with the end product, machine, system, or other application or use.

The following are some examples of applications for which particular attention must be given. This is not intended to be an exhaustive list of all possible uses of the products, nor is it intended to imply that the uses listed may be suitable for the products:

- Outdoor use, uses involving potential chemical contamination or electrical interference, or conditions or uses not described in this catalog.
- Nuclear energy control systems, combustion systems, railroad systems, aviation systems, medical equipment, amusement machines, vehicles, safety equipment, and installations subject to separate industry or government regulations.
- Systems, machines, and equipment that could present a risk to life or property.

Please know and observe all prohibitions of use applicable to the products.

NEVER USE THE PRODUCTS FOR AN APPLICATION INVOLVING SERIOUS RISK TO LIFE OR PROPERTY WITHOUT ENSURING THAT THE SYSTEM AS A WHOLE HAS BEEN DESIGNED TO ADDRESS THE RISKS, AND THAT THE OMRON PRODUCTS ARE PROPERLY RATED AND INSTALLED FOR THE INTENDED USE WITHIN THE OVERALL EQUIPMENT OR SYSTEM.

PROGRAMMABLE PRODUCTS

OMRON shall not be responsible for the user's programming of a programmable product, or any consequence thereof.

Disclaimers

CHANGE IN SPECIFICATIONS

Product specifications and accessories may be changed at any time based on improvements and other reasons.

It is our practice to change model numbers when published ratings or features are changed, or when significant construction changes are made. However, some specifications of the products may be changed without any notice. When in doubt, special model numbers may be assigned to fix or establish key specifications for your application on your request. Please consult with your OMRON representative at any time to confirm actual specifications of purchased products.

DIMENSIONS AND WEIGHTS

Dimensions and weights are nominal and are not to be used for manufacturing purposes, even when tolerances are shown.

PERFORMANCE DATA

Performance data given in this catalog is provided as a guide for the user in determining suitability and does not constitute a warranty. It may represent the result of OMRON's test conditions, and the users must correlate it to actual application requirements. Actual performance is subject to the OMRON Warranty and Limitations of Liability.

ERRORS AND OMISSIONS

The information in this document has been carefully checked and is believed to be accurate; however, no responsibility is assumed for clerical, typographical, or proofreading errors, or omissions.

2011.4

In the interest of product improvement, specifications are subject to change without notice.

OMRON Corporation
Industrial Automation Company

<http://www.ia.omron.com/>

(c)Copyright OMRON Corporation 2011 All Right Reserved.

Компания «Океан Электроники» предлагает заключение долгосрочных отношений при поставках импортных электронных компонентов на взаимовыгодных условиях!

Наши преимущества:

- Поставка оригинальных импортных электронных компонентов напрямую с производств Америки, Европы и Азии, а так же с крупнейших складов мира;
- Широкая линейка поставок активных и пассивных импортных электронных компонентов (более 30 млн. наименований);
- Поставка сложных, дефицитных, либо снятых с производства позиций;
- Оперативные сроки поставки под заказ (от 5 рабочих дней);
- Экспресс доставка в любую точку России;
- Помощь Конструкторского Отдела и консультации квалифицированных инженеров;
- Техническая поддержка проекта, помощь в подборе аналогов, поставка прототипов;
- Поставка электронных компонентов под контролем ВП;
- Система менеджмента качества сертифицирована по Международному стандарту ISO 9001;
- При необходимости вся продукция военного и аэрокосмического назначения проходит испытания и сертификацию в лаборатории (по согласованию с заказчиком);
- Поставка специализированных компонентов военного и аэрокосмического уровня качества (Xilinx, Altera, Analog Devices, Intersil, Interpoint, Microsemi, Actel, Aeroflex, Peregrine, VPT, Syfer, Eurofarad, Texas Instruments, MS Kennedy, Miteq, Cobham, E2V, MA-COM, Hittite, Mini-Circuits, General Dynamics и др.);

Компания «Океан Электроники» является официальным дистрибьютором и эксклюзивным представителем в России одного из крупнейших производителей разъемов военного и аэрокосмического назначения «JONHON», а так же официальным дистрибьютором и эксклюзивным представителем в России производителя высокотехнологичных и надежных решений для передачи СВЧ сигналов «FORSTAR».



JONHON

«JONHON» (основан в 1970 г.)

Разъемы специального, военного и аэрокосмического назначения:

(Применяются в военной, авиационной, аэрокосмической, морской, железнодорожной, горно- и нефтедобывающей отраслях промышленности)

«FORSTAR» (основан в 1998 г.)

ВЧ соединители, коаксиальные кабели, кабельные сборки и микроволновые компоненты:

(Применяются в телекоммуникациях гражданского и специального назначения, в средствах связи, РЛС, а так же военной, авиационной и аэрокосмической отраслях промышленности).



Телефон: 8 (812) 309-75-97 (многоканальный)

Факс: 8 (812) 320-03-32

Электронная почта: ocean@oceanchips.ru

Web: <http://oceanchips.ru/>

Адрес: 198099, г. Санкт-Петербург, ул. Калинина, д. 2, корп. 4, лит. А