

## 3-TERMINAL POSITIVE VOLTAGE REGULATOR

### ■ GENERAL DESCRIPTION

The NJM7800 series of monolithic 3-Terminal Positive Voltage Regulators is constructed using the New JRC Planar epitaxial process. These regulators employ internal current-limiting, thermal-shutdown and safe-area compensation making them essentially indestructible. If adequate heat sinking is provided, they can deliver over 1A output current. They are intended as fixed voltage regulators in a wide range of applications including local (on card) regulation for elimination of distribution problems associated with single point regulation. In addition to use as fixed voltage regulators, these devices can be used with external components to obtain adjustable output voltages and currents.

### ■ FEATURES

- Operating Voltage
- Internal Short Circuit Current Limit
- Internal Thermal Overload Protection
- Excellent Ripple Rejection
- Guarantee'd 1.5A Output Current
- Package Outline TO-220F, TO-252
- Bipolar Technology

### ■ EQUIVALENT CIRCUIT

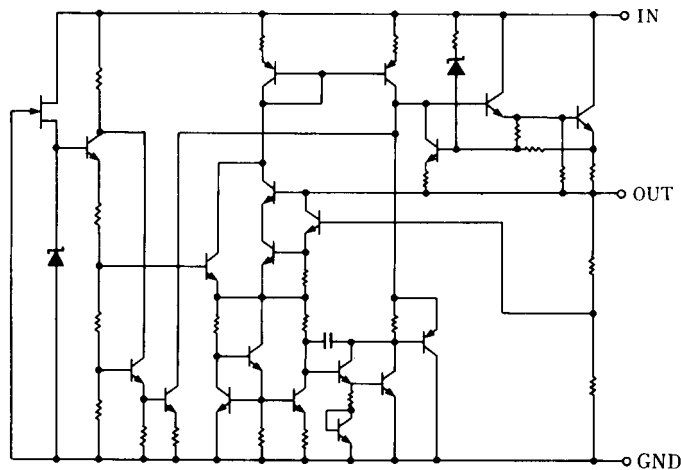

### ■ PACKAGE OUTLINE

( TO-220F )

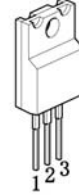

( TO-252 )

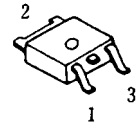

#### NJM7800FA

1. IN
2. GND
3. OUT

#### NJM7800DL1A

1. IN
2. GND
3. OUT

(note) The radiation fin is connected pin2.

# NJM7800

## ■ ABSOLUTE MAXIMUM RATINGS

(Ta=25°C)

PARAMETER	SYMBOL	MAXIMUM RATINGS		UNIT
Input Voltage	V <sub>IN</sub>	7805 to 7809 7812 to 7815 7818 to 7824	35 35 40	V
Storage Temperature Range	T <sub>stg</sub>	-40 to +150		°C
Operating Temperature Range	Operating Junction Temperature	T <sub>j</sub>	-40 to +150	°C
		T <sub>opr</sub>	-40 to +85	
Power Dissipation	P <sub>D</sub>	TO-220F TO-252	16(T <sub>C</sub> ≤70°C) 10(T <sub>C</sub> =25°C) 1(Ta≤25°C)	W

## ■ THERMAL CHARACTERISTICS

			TO220F	TO252		
Thermal Resistance	Junction-to-Ambient Temperature	θ <sub>ja</sub>	60	125	°C/W	
	Junction-to-Case	θ <sub>jc</sub>	5	12.5		

## ■ ELECTRICAL CHARACTERISTICS (C<sub>1</sub>=0.33μF, C<sub>O</sub>=0.1μF, T<sub>J</sub>=25°C)

Measurement is to be conducted in pulse testing.

PARAMETER	SYMBOL	TEST CONDITIONS	FTYP.			DL TYP.			UNIT
			MIN.	TYP.	MAX.	MIN.	TYP.	MAX.	
<b>NJM7805FA/DL1A</b>									
Output Voltage	V <sub>O</sub>	V <sub>IN</sub> =10V, I <sub>O</sub> =0.5A	4.8	5.0	5.2	4.8	5.0	5.2	V
Quiescent Current	I <sub>Q</sub>	V <sub>IN</sub> =10V, I <sub>O</sub> =0mA	-	4.2	6.0	-	4.2	6.0	mA
Load Regulation	ΔV <sub>O</sub> - I <sub>O</sub>	V <sub>IN</sub> =10V, I <sub>O</sub> =0.005 to 1.5A	-	15	50	-	15	100	mV
Line Regulation	ΔV <sub>O</sub> - V <sub>IN</sub>	V <sub>IN</sub> =7 to 25V, I <sub>O</sub> =0.5A	-	3	50	-	3	100	mV
Ripple Rejection	RR	V <sub>IN</sub> =10V, I <sub>O</sub> =0.5A, e <sub>in</sub> =2V <sub>P-P</sub> , f=120Hz	68	78	-	68	78	-	dB
Output Noise Voltage	V <sub>NO</sub>	V <sub>IN</sub> =10V, BW=10Hz to 100kHz, I <sub>O</sub> =0.5A	-	45	-	-	45	-	μV
Average Temperature Coefficient of Output Voltage	ΔV <sub>O</sub> /ΔT	V <sub>IN</sub> =10V, I <sub>O</sub> =5mA	-	-0.5	-	-	-0.5	-	mV/°C

■ **ELECTRICAL CHARACTERISTICS** ( $C_1=0.33\mu\text{F}$ ,  $C_O=0.1\mu\text{F}$ ,  $T_f=25^\circ\text{C}$ )

Measurement is to be conducted in pulse testing.

PARAMETER	SYMBOL	TEST CONDITIONS	FTYP.			DL TYP.			UNIT
			MIN.	TYP.	MAX.	MIN.	TYP.	MAX.	
<b>NJM7806FA/DL1</b>									
Output Voltage	$V_O$	$V_{IN}=11\text{V}$ , $I_O=0.5\text{A}$	5.75	6.0	6.25	5.75	6.0	6.25	V
Quiescent Current	$I_Q$	$V_{IN}=11\text{V}$ , $I_O=0\text{mA}$	-	4.3	6.0	-	4.3	6.0	mA
Load Regulation	$\Delta V_O - I_O$	$V_{IN}=11\text{V}$ , $I_O=0.005$ to $1.5\text{A}$	-	15	60	-	15	120	mV
Line Regulation	$\Delta V_O - V_{IN}$	$V_{IN}=8$ to $25\text{V}$ , $I_O=0.5\text{A}$	-	5	60	-	5	120	mV
Ripple Rejection	RR	$V_{IN}=11\text{V}$ , $I_O=0.5\text{A}$ , $e_{in}=2V_{P-P}$ , $f=120\text{Hz}$	65	75	-	65	75	-	dB
Output Noise Voltage	$V_{NO}$	$V_{IN}=11\text{V}$ , $BW=10\text{Hz}$ to $100\text{kHz}$ , $I_O=0.5\text{A}$	-	45	-	-	45	-	$\mu\text{V}$
Average Temperature Coefficient of Output Voltage	$\Delta V_O/\Delta T$	$V_{IN}=11\text{V}$ , $I_O=5\text{mA}$	-	-0.6	-	-	-0.6	-	$\text{mV}/^\circ\text{C}$
<b>NJM7808FA/DL1</b>									
Output Voltage	$V_O$	$V_{IN}=14\text{V}$ , $I_O=0.5\text{A}$	7.7	8.0	8.3	7.7	8.0	8.3	V
Quiescent Current	$I_Q$	$V_{IN}=14\text{V}$ , $I_O=0\text{mA}$	-	4.3	6.0	-	4.3	6.0	mA
Load Regulation	$\Delta V_O - I_O$	$V_{IN}=14\text{V}$ , $I_O=0.005$ to $1.5\text{A}$	-	15	80	-	15	160	mV
Line Regulation	$\Delta V_O - V_{IN}$	$V_{IN}=10.5$ to $25\text{V}$ , $I_O=0.5\text{A}$	-	6	80	-	6	160	mV
Ripple Rejection	RR	$V_{IN}=14\text{V}$ , $I_O=0.5\text{A}$ , $e_{in}=2V_{P-P}$ , $f=120\text{Hz}$	62	72	-	62	72	-	dB
Output Noise Voltage	$V_{NO}$	$V_{IN}=14\text{V}$ , $BW=10\text{Hz}$ to $100\text{kHz}$ , $I_O=0.5\text{A}$	-	55	-	-	55	-	$\mu\text{V}$
Average Temperature Coefficient of Output Voltage	$\Delta V_O/\Delta T$	$V_{IN}=14\text{V}$ , $I_O=5\text{mA}$	-	-0.8	-	-	-0.8	-	$\text{mV}/^\circ\text{C}$
<b>NJM7809FA/DL1</b>									
Output Voltage	$V_O$	$V_{IN}=15\text{V}$ , $I_O=0.5\text{A}$	8.65	9.0	9.35	8.65	9.0	9.35	V
Quiescent Current	$I_Q$	$V_{IN}=15\text{V}$ , $I_O=0\text{mA}$	-	4.3	6.0	-	4.3	6.0	mA
Load Regulation	$\Delta V_O - I_O$	$V_{IN}=15\text{V}$ , $I_O=0.005$ to $1.5\text{A}$	-	15	90	-	15	180	mV
Line Regulation	$\Delta V_O - V_{IN}$	$V_{IN}=11.5$ to $25\text{V}$ , $I_O=0.5\text{A}$	-	7	90	-	7	180	mV
Ripple Rejection	RR	$V_{IN}=15\text{V}$ , $I_O=0.5\text{A}$ , $e_{in}=2V_{P-P}$ , $f=120\text{Hz}$	62	72	-	62	72	-	dB
Output Noise Voltage	$V_{NO}$	$V_{IN}=15\text{V}$ , $BW=10\text{Hz}$ to $100\text{kHz}$ , $I_O=0.5\text{A}$	-	60	-	-	60	-	$\mu\text{V}$
Average Temperature Coefficient of Output Voltage	$\Delta V_O/\Delta T$	$V_{IN}=15\text{V}$ , $I_O=5\text{mA}$	-	-0.9	-	-	-0.9	-	$\text{mV}/^\circ\text{C}$
<b>NJM7812FA/DL1</b>									
Output Voltage	$V_O$	$V_{IN}=19\text{V}$ , $I_O=0.5\text{A}$	11.5	12.0	12.5	11.5	12.0	12.5	V
Quiescent Current	$I_Q$	$V_{IN}=19\text{V}$ , $I_O=0\text{mA}$	-	4.3	6.0	-	4.3	6.0	mA
Load Regulation	$\Delta V_O - I_O$	$V_{IN}=19\text{V}$ , $I_O=0.005$ to $1.5\text{A}$	-	25	120	-	25	240	mV
Line Regulation	$\Delta V_O - V_{IN}$	$V_{IN}=14.5$ to $30\text{V}$ , $I_O=0.5\text{A}$	-	10	120	-	10	240	mV
Ripple Rejection	RR	$V_{IN}=19\text{V}$ , $I_O=0.5\text{A}$ , $e_{in}=2V_{P-P}$ , $f=120\text{Hz}$	61	71	-	61	71	-	dB
Output Noise Voltage	$V_{NO}$	$V_{IN}=19\text{V}$ , $BW=10\text{Hz}$ to $100\text{kHz}$ , $I_O=0.5\text{A}$	-	75	-	-	75	-	$\mu\text{V}$
Average Temperature Coefficient of Output Voltage	$\Delta V_O/\Delta T$	$V_{IN}=19\text{V}$ , $I_O=5\text{mA}$	-	-1.2	-	-	-1.2	-	$\text{mV}/^\circ\text{C}$

# NJM7800

## ■ ELECTRICAL CHARACTERISTICS (C<sub>1</sub>=0.33μF, C<sub>O</sub>=0.1μF, T<sub>J</sub>=25°C)

Measurement is to be conducted in pulse testing.

PARAMETER	SYMBOL	TEST CONDITIONS	FTYP.			DL TYP.			UNIT
			MIN.	TYP.	MAX.	MIN.	TYP.	MAX.	
<b>NJM7815FA/DL1</b>									
Output Voltage	V <sub>O</sub>	V <sub>IN</sub> =23V, I <sub>O</sub> =0.5A	14.4	15.0	15.6	14.4	15.0	15.6	V
Quiescent Current	I <sub>Q</sub>	V <sub>IN</sub> =23V, I <sub>O</sub> =0mA	-	4.4	6.0	-	4.4	6.0	mA
Load Regulation	ΔV <sub>O</sub> - I <sub>O</sub>	V <sub>IN</sub> =23V, I <sub>O</sub> =0.005 to 1.5A	-	35	150	-	35	300	mV
Line Regulation	ΔV <sub>O</sub> - V <sub>IN</sub>	V <sub>IN</sub> =17.5 to 30V, I <sub>O</sub> =0.5A	-	11	150	-	11	300	mV
Ripple Rejection	RR	V <sub>IN</sub> =23V, I <sub>O</sub> =0.5A, e <sub>in</sub> =2V <sub>P-P</sub> , f=120Hz	60	70	-	60	70	-	dB
Output Noise Voltage	V <sub>NO</sub>	V <sub>IN</sub> =23V, BW=10Hz to 100kHz, I <sub>O</sub> =0.5A	-	90	-	-	90	-	μV
Average Temperature Coefficient of Output Voltage	ΔV <sub>O</sub> /ΔT	V <sub>IN</sub> =23V, I <sub>O</sub> =5mA	-	-1.5	-	-	-1.5	-	mV/°C
<b>NJM7818FA/DL1</b>									
Output Voltage	V <sub>O</sub>	V <sub>IN</sub> =27V, I <sub>O</sub> =0.5A	17.3	18.0	18.7	17.3	18.0	18.7	V
Quiescent Current	I <sub>Q</sub>	V <sub>IN</sub> =27V, I <sub>O</sub> =0mA	-	4.5	6.0	-	4.5	6.0	mA
Load Regulation	ΔV <sub>O</sub> - I <sub>O</sub>	V <sub>IN</sub> =27V, I <sub>O</sub> =0.005 to 1.5A	-	55	180	-	55	360	mV
Line Regulation	ΔV <sub>O</sub> - V <sub>IN</sub>	V <sub>IN</sub> =21 to 33V, I <sub>O</sub> =0.5A	-	15	180	-	15	360	mV
Ripple Rejection	RR	V <sub>IN</sub> =27V, I <sub>O</sub> =0.5A, e <sub>in</sub> =2V <sub>P-P</sub> , f=120Hz	59	69	-	59	69	-	dB
Output Noise Voltage	V <sub>NO</sub>	V <sub>IN</sub> =27V, BW=10Hz to 100kHz, I <sub>O</sub> =0.5A	-	100	-	-	100	-	μV
Average Temperature Coefficient of Output Voltage	ΔV <sub>O</sub> /ΔT	V <sub>IN</sub> =27V, I <sub>O</sub> =5mA	-	-1.8	-	-	-1.8	-	mV/°C
<b>NJM7820FA/DL1</b>									
Output Voltage	V <sub>O</sub>	V <sub>IN</sub> =29V, I <sub>O</sub> =0.5A	19.2	20.0	20.8	19.2	20.0	20.8	V
Quiescent Current	I <sub>Q</sub>	V <sub>IN</sub> =29V, I <sub>O</sub> =0mA	-	4.5	6.0	-	4.5	6.0	mA
Load Regulation	ΔV <sub>O</sub> - I <sub>O</sub>	V <sub>IN</sub> =29V, I <sub>O</sub> =0.005 to 1.5A	-	61	200	-	61	400	mV
Line Regulation	ΔV <sub>O</sub> - V <sub>IN</sub>	V <sub>IN</sub> =23 to 35V, I <sub>O</sub> =0.5A	-	16	200	-	16	400	mV
Ripple Rejection	RR	V <sub>IN</sub> =29V, I <sub>O</sub> =0.5A, e <sub>in</sub> =2V <sub>P-P</sub> , f=120Hz	58	68	-	58	68	-	dB
Output Noise Voltage	V <sub>NO</sub>	V <sub>IN</sub> =29V, BW=10Hz to 100kHz, I <sub>O</sub> =0.5A	-	120	-	-	120	-	μV
Average Temperature Coefficient of Output Voltage	ΔV <sub>O</sub> /ΔT	V <sub>IN</sub> =29V, I <sub>O</sub> =5mA	-	-2.0	-	-	-2.0	-	mV/°C
<b>NJM7824FA/DL1</b>									
Output Voltage	V <sub>O</sub>	V <sub>IN</sub> =33V, I <sub>O</sub> =0.5A	23.0	24.0	25.0	23.0	24.0	25.0	V
Quiescent Current	I <sub>Q</sub>	V <sub>IN</sub> =33V, I <sub>O</sub> =0mA	-	4.6	6.0	-	4.6	6.0	mA
Load Regulation	ΔV <sub>O</sub> - I <sub>O</sub>	V <sub>IN</sub> =33V, I <sub>O</sub> =0.005 to 1.5A	-	65	240	-	65	480	mV
Line Regulation	ΔV <sub>O</sub> - V <sub>IN</sub>	V <sub>IN</sub> =27 to 38V, I <sub>O</sub> =0.5A	-	18	240	-	18	480	mV
Ripple Rejection	RR	V <sub>IN</sub> =33V, I <sub>O</sub> =0.5A, e <sub>in</sub> =2V <sub>P-P</sub> , f=120Hz	56	66	-	56	66	-	dB
Output Noise Voltage	V <sub>NO</sub>	V <sub>IN</sub> =33V, BW=10Hz to 100kHz, I <sub>O</sub> =0.5A	-	120	-	-	120	-	μV
Average Temperature Coefficient of Output Voltage	ΔV <sub>O</sub> /ΔT	V <sub>IN</sub> =33V, I <sub>O</sub> =5mA	-	-2.4	-	-	-2.4	-	mV/°C

## POWER DISSIPATION VS. AMBIENT TEMPERATURE

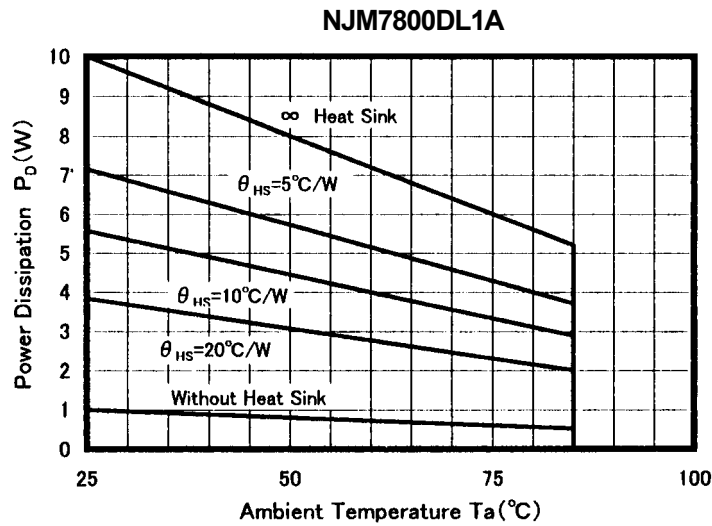
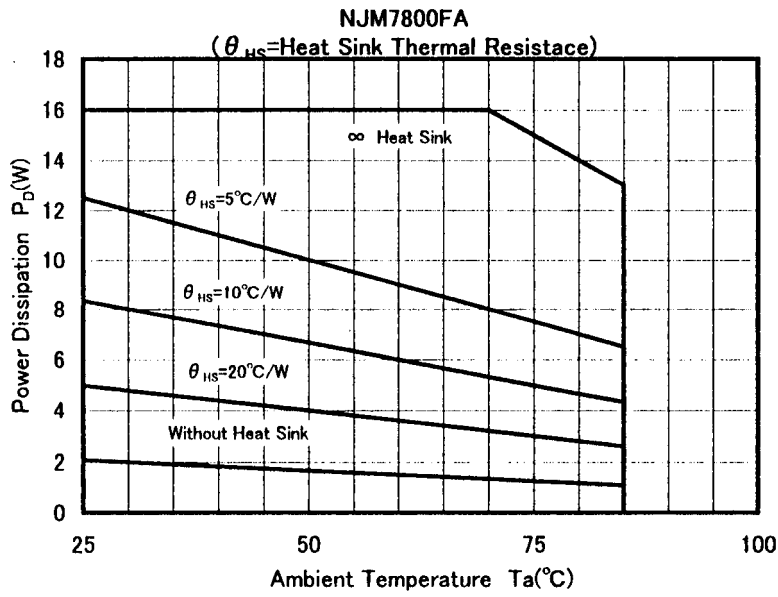

## TEST CIRCUIT

- Output Voltage, Line Regulation, Load Regulation, Quiescent Current, Average Temperature Coefficient of Output Voltage, Output Noise Voltage
- Ripple Rejection

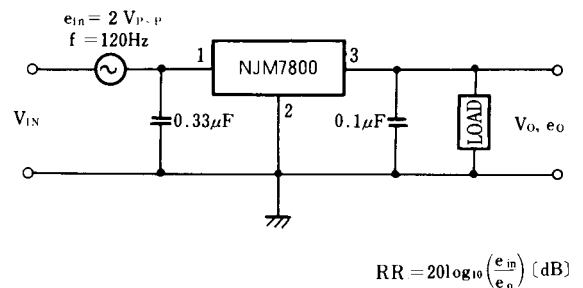
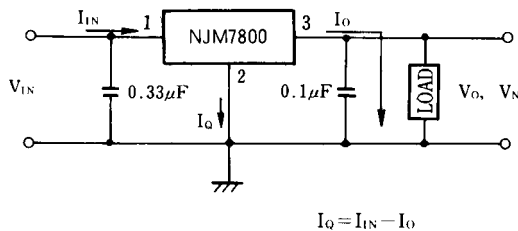

# NJM7800

## ■ TYPICAL CHARACTERISTICS

**NJM7805/15/24 Output Characteristics**  
( $I_o=0.5A$ ,  $T_j=25^\circ C$ )

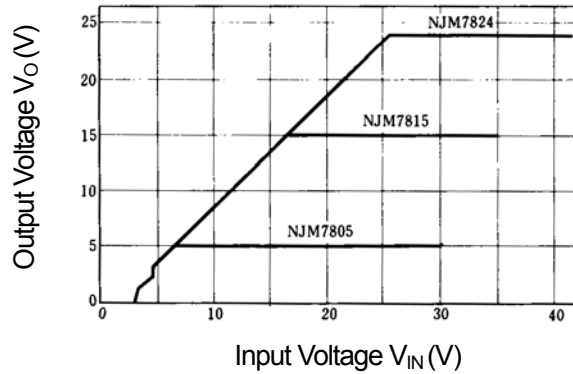

**NJM7805 Dropout Characteristics**  
( $T_j=25^\circ C$ )

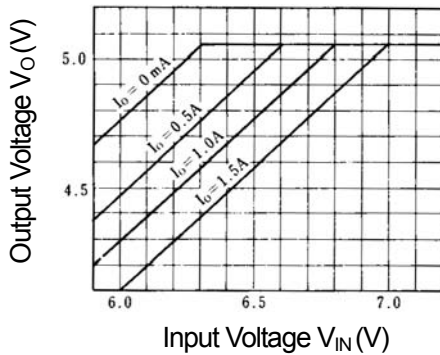

**NJM7812 Dropout Characteristics**  
( $T_j=25^\circ C$ )

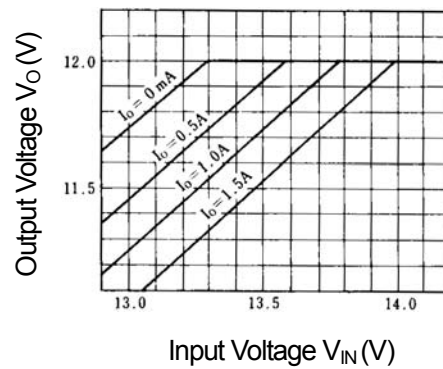

**NJM7805/15/24 Load Characteristics**  
( $T_j=25^\circ C$ )

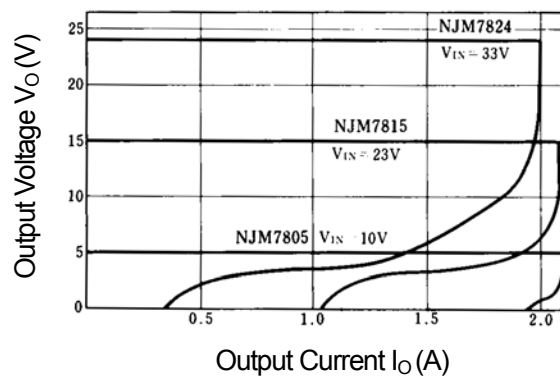

## ■ TYPICAL CHARACTERISTICS

### NJM7800 Series Short Circuit Output Current

( $T_j=25^\circ\text{C}$ ,  $\infty$  Heat Sink)

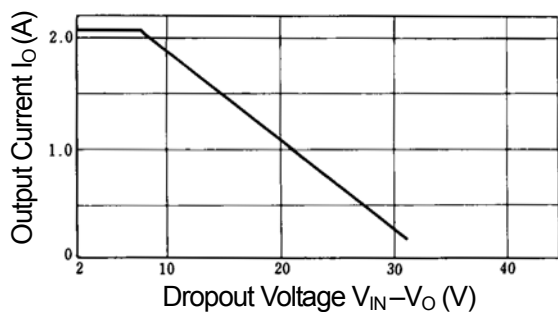

### NJM7805/24 Quiescent Current vs. Input Voltage

( $T_j=25^\circ\text{C}$ .)

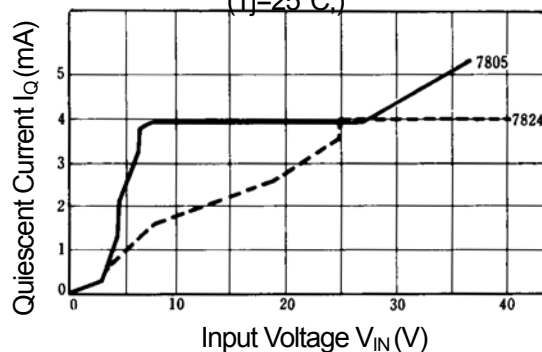

### NJM7805/15/24 Output Voltage vs. Junction Temperature

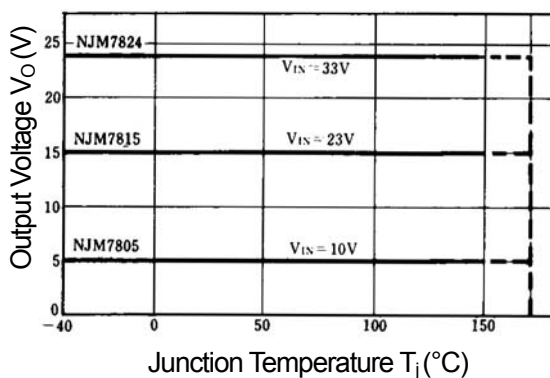

### NJM7805/15/24 Ripple Rejection vs. Frequency

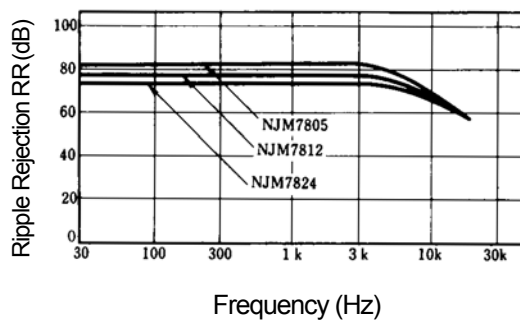

$V_{IN} = 10\text{V}$  (05)  $e_{in} = 2V_{P-P}$   
 19V (12)  
 33V (24)  
 $T_j = 25^\circ\text{C}$

## ■ TYPICAL CHARACTERISTICS

### NJM7805 Output Voltage vs. Temperature

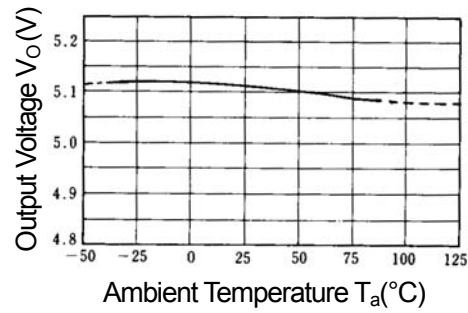

### NJM7808 Output Voltage vs. Temperature

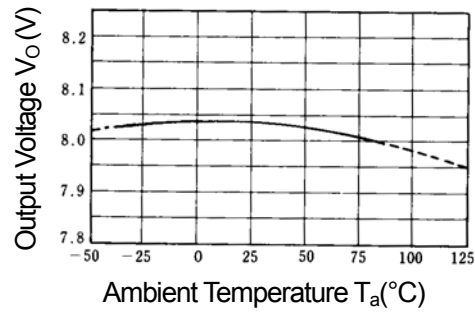

**[CAUTION]**

The specifications on this databook are only given for information, without any guarantee as regards either mistakes or omissions. The application circuits in this databook are described only to show representative usages of the product and not intended for the guarantee or permission of any right including the industrial rights.



Компания «Океан Электроники» предлагает заключение долгосрочных отношений при поставках импортных электронных компонентов на взаимовыгодных условиях!

Наши преимущества:

- Поставка оригинальных импортных электронных компонентов напрямую с производств Америки, Европы и Азии, а так же с крупнейших складов мира;
- Широкая линейка поставок активных и пассивных импортных электронных компонентов (более 30 млн. наименований);
- Поставка сложных, дефицитных, либо снятых с производства позиций;
- Оперативные сроки поставки под заказ (от 5 рабочих дней);
- Экспресс доставка в любую точку России;
- Помощь Конструкторского Отдела и консультации квалифицированных инженеров;
- Техническая поддержка проекта, помощь в подборе аналогов, поставка прототипов;
- Поставка электронных компонентов под контролем ВП;
- Система менеджмента качества сертифицирована по Международному стандарту ISO 9001;
- При необходимости вся продукция военного и аэрокосмического назначения проходит испытания и сертификацию в лаборатории (по согласованию с заказчиком);
- Поставка специализированных компонентов военного и аэрокосмического уровня качества (Xilinx, Altera, Analog Devices, Intersil, Interpoint, Microsemi, Actel, Aeroflex, Peregrine, VPT, Syfer, Eurofarad, Texas Instruments, MS Kennedy, Miteq, Cobham, E2V, MA-COM, Hittite, Mini-Circuits, General Dynamics и др.);

Компания «Океан Электроники» является официальным дистрибьютором и эксклюзивным представителем в России одного из крупнейших производителей разъемов военного и аэрокосмического назначения «JONHON», а так же официальным дистрибьютором и эксклюзивным представителем в России производителя высокотехнологичных и надежных решений для передачи СВЧ сигналов «FORSTAR».



## JONHON

«JONHON» (основан в 1970 г.)

Разъемы специального, военного и аэрокосмического назначения:

(Применяются в военной, авиационной, аэрокосмической, морской, железнодорожной, горно- и нефтедобывающей отраслях промышленности)

«FORSTAR» (основан в 1998 г.)

ВЧ соединители, коаксиальные кабели,  
кабельные сборки и микроволновые компоненты:

(Применяются в телекоммуникациях гражданского и специального назначения, в средствах связи, РЛС, а так же военной, авиационной и аэрокосмической отраслях промышленности).



Телефон: 8 (812) 309-75-97 (многоканальный)

Факс: 8 (812) 320-03-32

Электронная почта: [ocean@oceanchips.ru](mailto:ocean@oceanchips.ru)

Web: <http://oceanchips.ru/>

Адрес: 198099, г. Санкт-Петербург, ул. Калинина, д. 2, корп. 4, лит. А