

## High Speed Optocoupler, 10 Mbd

### Features

- Choice of CMR performance of 10 kV/μs, 5 kV/μs, and 100 V/μs
- High speed: 10 Mbd typical
- + 5 V CMOS compatibility
- Guaranteed AC and DC performance over temperature: - 40 to + 100 °C Temp. Range
- Pure tin leads
- Meets IEC60068-2-42 (SO<sub>2</sub>) and IEC60068-2-43 (H<sub>2</sub>S) requirements
- Low input current capability: 5 mA
- Lead-free component
- Component in accordance to RoHS 2002/95/EC and WEEE 2002/96/EC

### Agency Approvals

- UL1577, File No. E52744 System Code H or J, Double Protection
- CUL - File No. E52744, equivalent to CSA bulletin 5A
- DIN EN 60747-5-2 (VDE0884)
- Reinforced insulation rating per IEC60950 2.10.5.1
- VDE available with Option 1

### Applications

Microprocessor System Interface  
 PLC, ATE input/output isolation  
 Computer peripheral interface  
 Digital Fieldbus Isolation: CC-Link, DeviceNet, Profibus, SDS  
 High speed A/D and D/A conversion  
 AC Plasma Display Panel Level Shifting  
 Multiplexed Data Transmission  
 Digital control power supply  
 Ground loop elimination

### Description

The 6N137, SFH674x and SFH675x are single channel 10 Mbd optocouplers utilizing a high efficient input LED coupled with an integrated optical photodiode IC detector. The detector has an open drain NMOS-transistor output, providing less leakage compared to an open collector Schottky clamped transistor output.



SFH6745T, SFH6746T, SFH6747T SFH6755T, SFH6756T, SFH6757T  
 18921-3

For the single channel type, an enable function on pin 7 allows the detector to be strobed. The internal shield provides a guaranteed common mode transient immunity of 5 kV/μs for the SFH6741 and SFH6751 and 10 kV/μs for the SFH6742 and SFH6752. The use of a 0.1 μF bypass capacitor connected between pin 5 and 8 is recommended.

### Order Information

Part	Remarks
6N137	100 V/μs, Single channel, DIP-8
6N137-X006	100 V/μs, Single channel, DIP-8 400 mil (option 6)
6N137-X007	100 V/μs, Single channel, SMD-8 (option 7)
SFH6741	5 kV/μs, Single channel, DIP-8
SFH6741-X006	5 kV/μs, Single channel, DIP-8 400 mil (option 6)
SFH6741-X007	5 kV/μs, Single channel, SMD-8 (option 7)
SFH6742	10 kV/μs, Single channel, DIP-8
SFH6742-X006	10 kV/μs, Single channel, DIP-8 400 mil (option 6)
SFH6742-X007	10 kV/μs, Single channel, SMD-8 (option 7)
SFH6750	100 V/μs, Dual channel, DIP-8
SFH6750-X006	100 V/μs, Dual channel, DIP-8 400 mil (option 6)
SFH6750-X007	100 V/μs, Dual channel, SMD-8 (option 7)
SFH6751	5 kV/μs, Dual channel, DIP-8

Part	Remarks
SFH6751-X006	5 kV/μs, Dual channel, DIP-8 400 mil (option 6)
SFH6751-X007	5 kV/μs, Dual channel, SMD-8 (option 7)
SFH6752	10 kV/μs, Dual channel, DIP-8
SFH6752-X006	10 kV/μs, Dual channel, DIP-8 400 mil (option 6)
SFH6752-X007	10 kV/μs, Dual channel, SMD-8 (option 7)

### Truth Table (Positive Logic)

LED	ENABLE	OUTPUT
ON	H	L
OFF	H	H
ON	L	H
OFF	L	H
ON	NC	L
OFF	NC	H

### Absolute Maximum Ratings

$T_{amb} = 25\text{ }^{\circ}\text{C}$ , unless otherwise specified

Stresses in excess of the absolute Maximum Ratings can cause permanent damage to the device. Functional operation of the device is not implied at these or any other conditions in excess of those given in the operational sections of this document. Exposure to absolute Maximum Rating for extended periods of the time can adversely affect reliability.

### Input

Parameter	Test condition	Symbol	Value	Unit
Average forward current <sup>1)</sup>		$I_F$	20	mA
Average forward current <sup>2)</sup>		$I_F$	15	mA
Reverse input voltage		$V_R$	5	V
Enable input voltage <sup>1)</sup>		$V_E$	$V_{CC} + 0.5\text{ V}$	V
Enable input current <sup>1)</sup>		$I_E$	5	mA
Surge current	$t = 100\text{ }\mu\text{s}$	$I_{FSM}$	200	mA

<sup>1)</sup> Package: Single DIP-8

<sup>2)</sup> Package: Dual DIP-8

### Output

Parameter	Test condition	Symbol	Value	Unit
Supply voltage	1 minute max.	$V_{CC}$	7	V
Output current		$I_O$	50	mA
Output voltage		$V_O$	7	V
Output power dissipation <sup>1)</sup>		$P_{diss}$	85	mW
Output power dissipation per channel <sup>2)</sup>		$P_{diss}$	60	mW

<sup>1)</sup> Package: Single DIP-8

<sup>2)</sup> Package: Dual DIP-8

### Coupler

Parameter	Test condition	Symbol	Value	Unit
Storage temperature		$T_{stg}$	- 55 to + 150	$^{\circ}\text{C}$
Operating temperature		$T_{amb}$	- 40 to + 100	$^{\circ}\text{C}$
Lead solder temperature <sup>1)</sup>	for 10 sec.		260	$^{\circ}\text{C}$
Solder reflow temperature <sup>2)</sup>	for 1 minute		260	$^{\circ}\text{C}$
Isolation test voltage	$t = 1.0\text{ sec.}$	$V_{ISO}$	5300	$V_{RMS}$

<sup>1)</sup> Package: DIP-8 through hole

<sup>2)</sup> Package: DIP-8 SMD



### Recommended Operating Conditions

Parameter	Test condition	Symbol	Min	Typ.	Max	Unit
Operating temperature		$T_{amb}$	- 40		100	°C
Supply voltage		$V_{cc}$	4.5		5.5	V
Input current low level		$I_{FL}$	0		250	μA
Input current high level		$I_{FH}$	5		15	mA
Logic high enable voltage		$V_{EH}$	2.0		$V_{CC}$	V
Logic low enable voltage		$V_{EL}$	0.0		0.8	V
Output pull up resistor		$R_L$	330		4 K	Ω
Fanout	$R_L = 1\text{ k}\Omega$	N			5	-

### Electrical Characteristics

$T_{amb} = 25\text{ °C}$  and  $V_{cc} = 5.5\text{ V}$ , unless otherwise specified

Minimum and maximum values are testing requirements. Typical values are characteristics of the device and are the result of engineering evaluation. Typical values are for information only and are not part of the testing requirements.

### Input

Parameter	Test condition	Symbol	Min	Typ.	Max	Unit
Input forward voltage	$I_F = 10\text{ mA}$	$V_F$	1.1	1.4	1.7	V
Reverse current	$V_R = 4.5\text{ V}$	$I_R$		1		μA
Input capacitance	$f = 1\text{ MHz}$ , $V_F = 0\text{ V}$	$C_I$		55		pF

### Output

Parameter	Test condition	Symbol	Min	Typ.	Max	Unit
High level supply current (single channel)	$V_E = 0.5\text{ V}$ , $I_F = 0\text{ mA}$	$I_{CCH}$		4.1	7.0	mA
	$V_E = V_{CC}$ , $I_F = 0\text{ mA}$	$I_{CCH}$		3.3	6.0	mA
High level supply current (dual channel)	$I_F = 0\text{ mA}$	$I_{CCH}$		8.2	14.0	mA
Low level supply current	$V_E = 0.5\text{ V}$ , $I_F = 10\text{ mA}$	$I_{CCL}$		4.0	7.0	mA
	$V_E = V_{CC}$ , $I_F = 10\text{ mA}$	$I_{CCL}$		3.3	6.0	mA
High level output current	$V_E = 2.0\text{ V}$ , $V_O = 5.5\text{ V}$ , $I_F = 250\text{ }\mu\text{A}$	$I_{OH}$		0.002	1	μA
Low level output voltage	$V_E = 2.0\text{ V}$ , $I_F = 5\text{ mA}$ , $I_{OL}(\text{sinking}) = 13\text{ mA}$	$V_{OL}$		0.2	0.6	V
Input threshold current	$V_E = 2.0\text{ V}$ , $V_O = 5.5\text{ V}$ , $I_{OL}(\text{sinking}) = 13\text{ mA}$	$I_{TH}$		2.4	5.0	mA
High level enable current	$V_E = 2.0\text{ V}$	$I_{EH}$		- 0.6	- 1.6	mA
Low level enable current	$V_E = 0.5\text{ V}$	$I_{EL}$		- 0.8	- 1.6	mA
High level enable voltage		$V_{EH}$	2.0			V
Low level enable voltage		$V_{EL}$			0.8	V

### Switching Characteristics

Over Recommended Temperature ( $T_a = -40$  to  $+100$  °C),  $V_{CC} = 5$  V,  $I_F = 7.5$  mA unless otherwise specified.

All Typical at  $T_a = 25$  °C,  $V_{CC} = 5$  V.

Parameter	Test condition	Symbol	Min	Typ.	Max	Unit
Propagation delay time to high output level	$R_L = 350 \Omega$ , $C_L = 15$ pF	$t_{PLH}$	20	48	75*	ns
		$t_{PLH}$			100	ns
Propagation delay time to low output level	$R_L = 350 \Omega$ , $C_L = 15$ pF	$t_{PHL}$	25	50	75*	ns
		$t_{PHL}$			100	ns
Pulse width distortion	$R_L = 350 \Omega$ , $C_L = 15$ pF	$ t_{PHL} - t_{PLH} $		2.9	35	ns
Propagation delay skew	$R_L = 350 \Omega$ , $C_L = 15$ pF	$t_{PSK}$		8	40	ns
Output rise time (10 - 90 %)	$R_L = 350 \Omega$ , $C_L = 15$ pF	$t_r$		23		ns
Output fall time (90 - 10 %)	$R_L = 350 \Omega$ , $C_L = 15$ pF	$t_f$		7		ns
Propagation delay time of enable from $V_{EH}$ to $V_{EL}$	$R_L = 350 \Omega$ , $C_L = 15$ pF, $V_{EL} = 0$ V, $V_{EH} = 3$ V	$t_{ELH}$		12		ns
Propagation delay time of enable from $V_{EL}$ to $V_{EH}$	$R_L = 350 \Omega$ , $C_L = 15$ pF, $V_{EL} = 0$ V, $V_{EH} = 3$ V	$t_{EHL}$		11		ns

\* 75ns applies to the 6N137 only, a JEDEC registered specification



Figure 1. Single Channel Test Circuit for  $t_{PLH}$ ,  $t_{PHL}$ ,  $t_r$  and  $t_f$



Figure 2. Dual Channel Test Circuit for  $t_{PLH}$ ,  $t_{PHL}$ ,  $t_r$  and  $t_f$

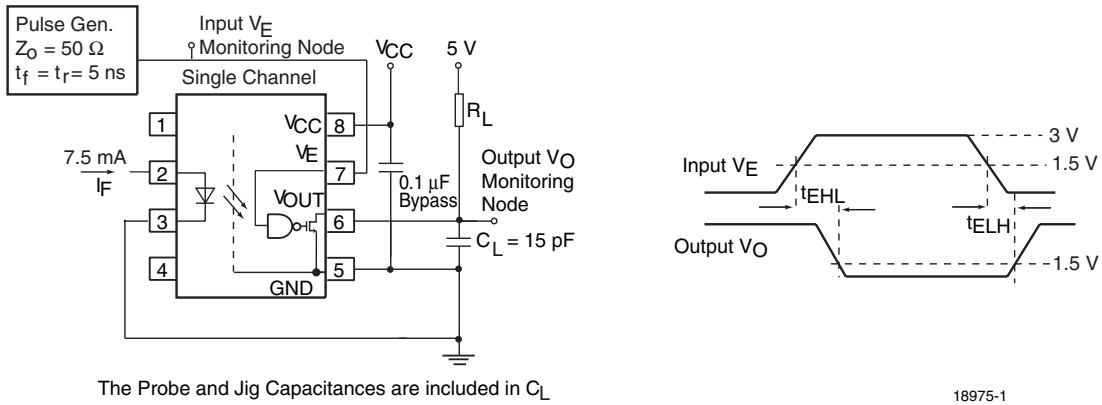

The Probe and Jig Capacitances are included in  $C_L$

18975-1

Figure 3. Single Channel Test Circuit for  $t_{EHL}$  and  $t_{ELH}$

### Common Mode Transient Immunity

Parameter	Test condition	Symbol	Min	Typ.	Max	Unit
Common mode transient immunity (high)	$ V_{CM}  = 10 \text{ V}$ , $V_{CC} = 5 \text{ V}$ , $I_F = 0 \text{ mA}$ , $V_{O(\min)} = 2 \text{ V}$ , $R_L = 350 \Omega$ , $T_{\text{amb}} = 25 \text{ }^\circ\text{C}$ <sup>1)</sup>	$ CM_H $	100			V/ $\mu\text{s}$
	$ V_{CM}  = 50 \text{ V}$ , $V_{CC} = 5 \text{ V}$ , $I_F = 0 \text{ mA}$ , $V_{O(\min)} = 2 \text{ V}$ , $R_L = 350 \Omega$ , $T_{\text{amb}} = 25 \text{ }^\circ\text{C}$ <sup>2)</sup>	$ CM_H $	5000	10000		V/ $\mu\text{s}$
	$ V_{CM}  = 1 \text{ kV}$ , $V_{CC} = 5 \text{ V}$ , $I_F = 0 \text{ mA}$ , $V_{O(\min)} = 2 \text{ V}$ , $R_L = 350 \Omega$ , $T_{\text{amb}} = 25 \text{ }^\circ\text{C}$ <sup>3)</sup>	$ CM_H $	10000	15000		V/ $\mu\text{s}$
	$ V_{CM}  = 10 \text{ V}$ , $V_{CC} = 5 \text{ V}$ , $I_F = 7.5 \text{ mA}$ , $V_{O(\max)} = 0.8 \text{ V}$ , $R_L = 350 \Omega$ , $T_{\text{amb}} = 25 \text{ }^\circ\text{C}$ <sup>1)</sup>	$ CM_L $	100			V/ $\mu\text{s}$
	$ V_{CM}  = 50 \text{ V}$ , $V_{CC} = 5 \text{ V}$ , $I_F = 7.5 \text{ mA}$ , $V_{O(\max)} = 0.8 \text{ V}$ , $R_L = 350 \Omega$ , $T_{\text{amb}} = 25 \text{ }^\circ\text{C}$ <sup>2)</sup>	$ CM_L $	5000	10000		V/ $\mu\text{s}$
	$ V_{CM}  = 1 \text{ kV}$ , $V_{CC} = 5 \text{ V}$ , $I_F = 7.5 \text{ mA}$ , $V_{O(\max)} = 0.8 \text{ V}$ , $R_L = 350 \Omega$ , $T_{\text{amb}} = 25 \text{ }^\circ\text{C}$ <sup>3)</sup>	$ CM_L $	10000	15000		V/ $\mu\text{s}$

1) For 6N137 and SFH6750

2) For SFH6741 and SFH6751

3) For SFH6742 and SFH6752



Figure 4. Single Channel Test Circuit for Common Mode Transient Immunity



Figure 5. Dual Channel Test Circuit for Common Mode Transient Immunity

## Safety and Insulation Ratings

As per IEC60747-5-2, §7.4.3.8.1, this optocoupler is suitable for "safe electrical insulation" only within the safety ratings. Compliance with the safety ratings shall be ensured by means of protective circuits.

Parameter	Test condition	Symbol	Min	Typ.	Max	Unit
Climatic Classification (according to IEC 68 part 1)				55/110/21		
Comparative Tracking Index		CTI	175		399	
$V_{IOTM}$			8000			V
$V_{IORM}$			630			V
$P_{SI}$					500	mW
$I_{SI}$					300	mA
$T_{SI}$					175	°C
Creepage	standard DIP-8		7			mm
Clearance	standard DIP-8		7			mm
Creepage	400mil DIP-8		8			mm
Clearance	400mil DIP-8		8			mm
Insulation thickness, reinforced rated	per IEC60950 2.10.5.1		0.2			mm

## Typical Characteristics ( $T_{amb} = 25\text{ }^{\circ}\text{C}$ unless otherwise specified)



Figure 6. Forward Voltage vs. Ambient Temperature



Figure 7. Forward Voltage vs. Forward Current

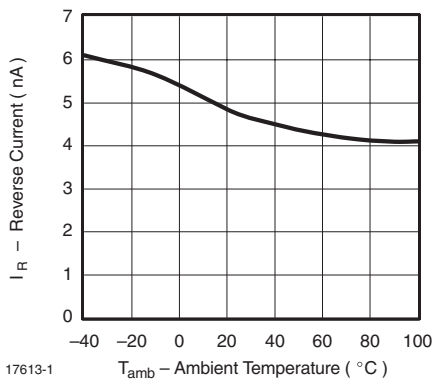

Figure 8. Reverse Current vs. Ambient Temperature

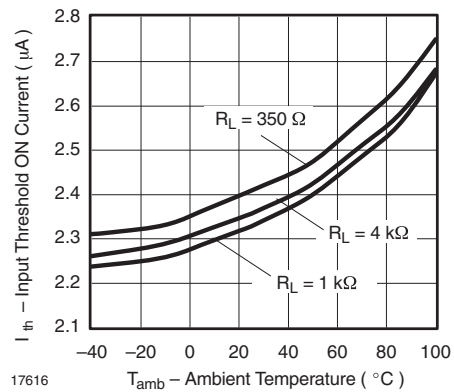

Figure 11. Input Threshold ON Current vs. Ambient Temperature

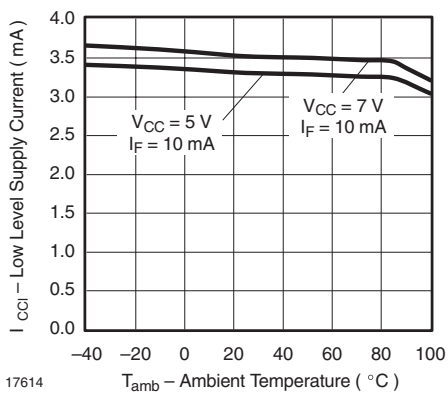

Figure 9. Low Level Supply Current vs. Ambient Temperature

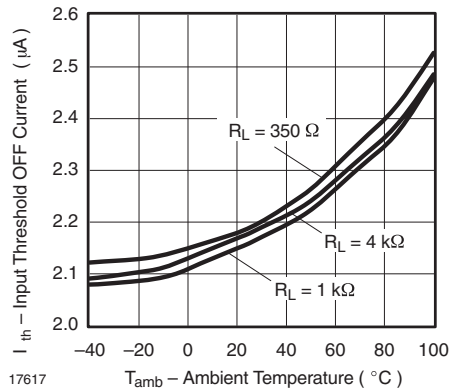

Figure 12. Input Threshold OFF Current vs. Ambient Temperature

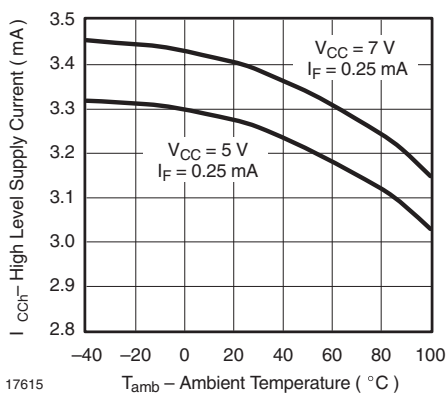

Figure 10. High Level Supply Current vs. Ambient Temperature

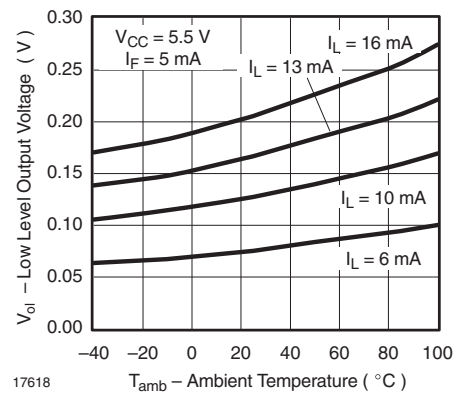

Figure 13. Low Level Output Voltage vs. Ambient Temperature



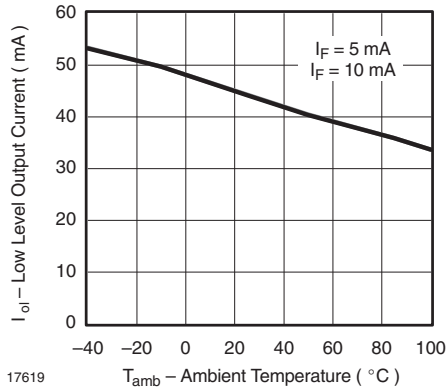

Figure 14. Low Level Output Current vs. Ambient Temperature

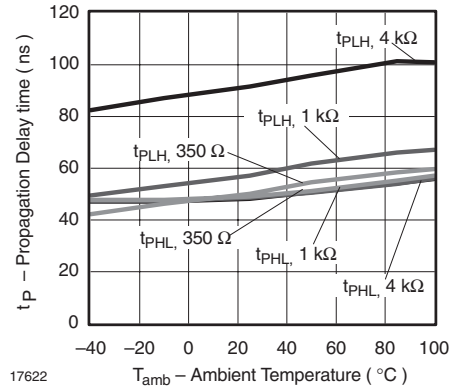

Figure 17. Propagation Delay vs. Ambient Temperature



Figure 15. High Level Output Current vs. Ambient Temperature



Figure 18. Propagation Delay vs. Forward Current



Figure 16. Output Voltage vs. Forward Input Current



Figure 19. Pulse Width Distortion vs. Ambient Temperature



Figure 20. Pulse Width Distortion vs. Forward Current



Figure 23. Enable Propagation Delay vs. Ambient Temperature



Figure 21. Rise and Fall Time vs. Ambient Temperature



Figure 22. Rise and Fall Time vs. Forward Current



## Package Dimensions in Inches (mm)

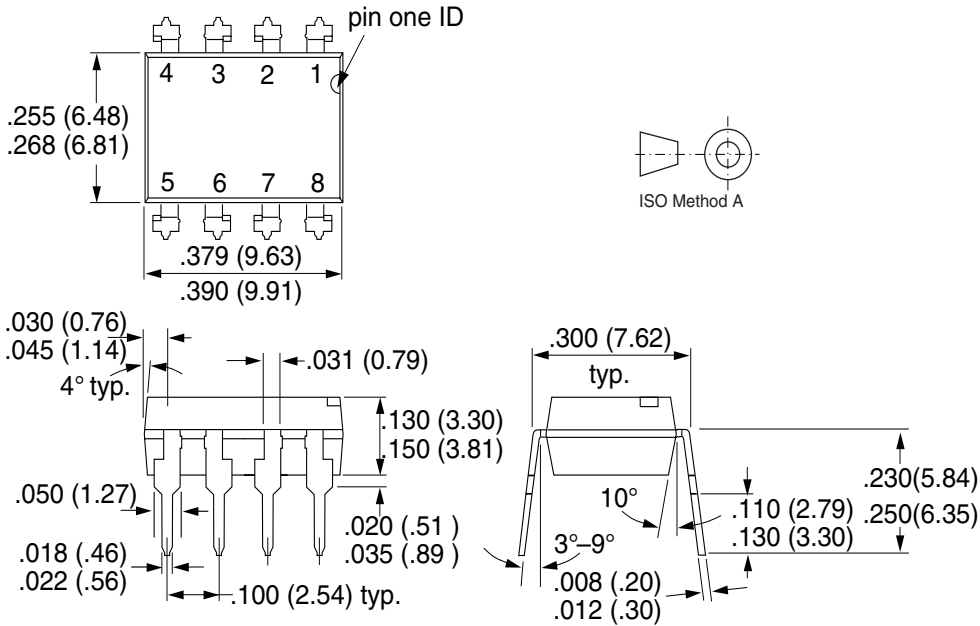

i178006

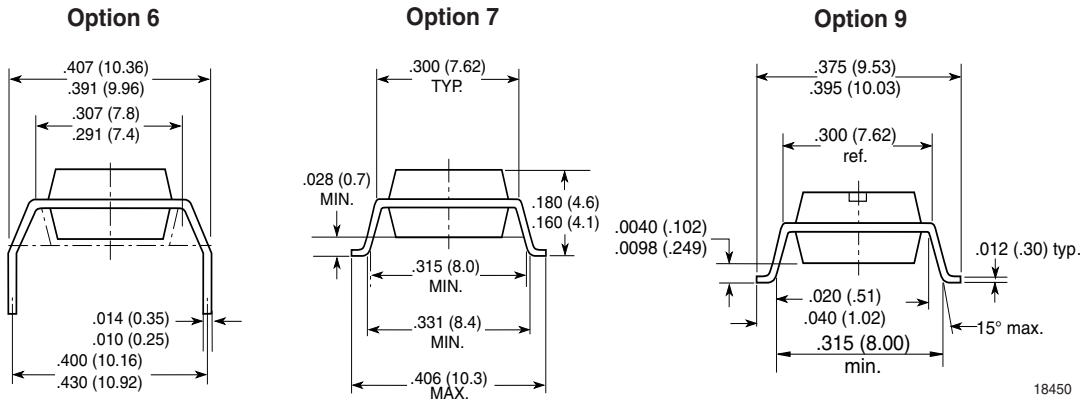

18450

### Ozone Depleting Substances Policy Statement

It is the policy of Vishay Semiconductor GmbH to

1. Meet all present and future national and international statutory requirements.
2. Regularly and continuously improve the performance of our products, processes, distribution and operating systems with respect to their impact on the health and safety of our employees and the public, as well as their impact on the environment.

It is particular concern to control or eliminate releases of those substances into the atmosphere which are known as ozone depleting substances (ODSs).

The Montreal Protocol (1987) and its London Amendments (1990) intend to severely restrict the use of ODSs and forbid their use within the next ten years. Various national and international initiatives are pressing for an earlier ban on these substances.

Vishay Semiconductor GmbH has been able to use its policy of continuous improvements to eliminate the use of ODSs listed in the following documents.

1. Annex A, B and list of transitional substances of the Montreal Protocol and the London Amendments respectively
2. Class I and II ozone depleting substances in the Clean Air Act Amendments of 1990 by the Environmental Protection Agency (EPA) in the USA
3. Council Decision 88/540/EEC and 91/690/EEC Annex A, B and C (transitional substances) respectively.

Vishay Semiconductor GmbH can certify that our semiconductors are not manufactured with ozone depleting substances and do not contain such substances.

We reserve the right to make changes to improve technical design  
and may do so without further notice.

Parameters can vary in different applications. All operating parameters must be validated for each customer application by the customer. Should the buyer use Vishay Semiconductors products for any unintended or unauthorized application, the buyer shall indemnify Vishay Semiconductors against all claims, costs, damages, and expenses, arising out of, directly or indirectly, any claim of personal damage, injury or death associated with such unintended or unauthorized use.

Vishay Semiconductor GmbH, P.O.B. 3535, D-74025 Heilbronn, Germany  
Telephone: 49 (0)7131 67 2831, Fax number: 49 (0)7131 67 2423



# 6N137/ SFH6741 / 42 / 50 / 51 / 52

---

Vishay Semiconductors

This datasheet has been download from:

[www.datasheetcatalog.com](http://www.datasheetcatalog.com)

Datasheets for electronics components.

Компания «Океан Электроники» предлагает заключение долгосрочных отношений при поставках импортных электронных компонентов на взаимовыгодных условиях!

Наши преимущества:

- Поставка оригинальных импортных электронных компонентов напрямую с производств Америки, Европы и Азии, а так же с крупнейших складов мира;
- Широкая линейка поставок активных и пассивных импортных электронных компонентов (более 30 млн. наименований);
- Поставка сложных, дефицитных, либо снятых с производства позиций;
- Оперативные сроки поставки под заказ (от 5 рабочих дней);
- Экспресс доставка в любую точку России;
- Помощь Конструкторского Отдела и консультации квалифицированных инженеров;
- Техническая поддержка проекта, помощь в подборе аналогов, поставка прототипов;
- Поставка электронных компонентов под контролем ВП;
- Система менеджмента качества сертифицирована по Международному стандарту ISO 9001;
- При необходимости вся продукция военного и аэрокосмического назначения проходит испытания и сертификацию в лаборатории (по согласованию с заказчиком);
- Поставка специализированных компонентов военного и аэрокосмического уровня качества (Xilinx, Altera, Analog Devices, Intersil, Interpoint, Microsemi, Actel, Aeroflex, Peregrine, VPT, Syfer, Eurofarad, Texas Instruments, MS Kennedy, Miteq, Cobham, E2V, MA-COM, Hittite, Mini-Circuits, General Dynamics и др.);

Компания «Океан Электроники» является официальным дистрибьютором и эксклюзивным представителем в России одного из крупнейших производителей разъемов военного и аэрокосмического назначения «JONHON», а так же официальным дистрибьютором и эксклюзивным представителем в России производителя высокотехнологичных и надежных решений для передачи СВЧ сигналов «FORSTAR».



## JONHON

«JONHON» (основан в 1970 г.)

Разъемы специального, военного и аэрокосмического назначения:

(Применяются в военной, авиационной, аэрокосмической, морской, железнодорожной, горно- и нефтедобывающей отраслях промышленности)

«FORSTAR» (основан в 1998 г.)

ВЧ соединители, коаксиальные кабели, кабельные сборки и микроволновые компоненты:

(Применяются в телекоммуникациях гражданского и специального назначения, в средствах связи, РЛС, а так же военной, авиационной и аэрокосмической отраслях промышленности).



Телефон: 8 (812) 309-75-97 (многоканальный)

Факс: 8 (812) 320-03-32

Электронная почта: [ocean@oceanchips.ru](mailto:ocean@oceanchips.ru)

Web: <http://oceanchips.ru/>

Адрес: 198099, г. Санкт-Петербург, ул. Калинина, д. 2, корп. 4, лит. А