

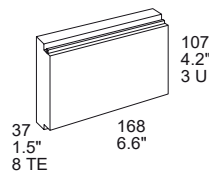

## PSC/PSL Series Positive Switching Regulators

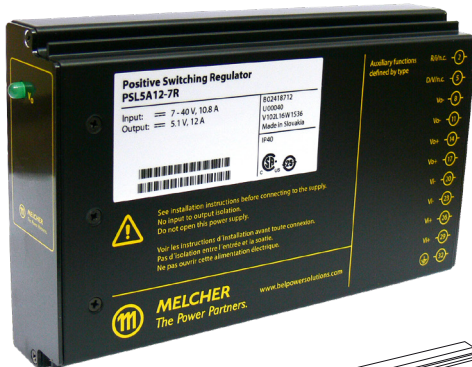
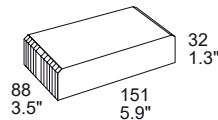

The PSC and PSL Series positive switching regulators are designed as power supplies for electronic systems, where no input-to-output isolation is required. Their major advantages include a high level of efficiency, high reliability, low output ripple, and excellent dynamic response. Models with input voltages up to 144 V are specially designed for secondary switched and battery-driven mobile applications. The converters are suitable for railway applications according to EN 50155 and EN 50121. Two type of housings are available allowing operation up to 71 °C. The PSC Series is designed for wall or chassis mounting with faston connections, whereas the PSL Series is designed for insertion into a 19" DIN-rack and exhibits a H11 connector. Various options are available to adapt the converters to different applications.

### Features

- RoHS lead-free-solder and lead-solder-exempted products are available
- 5 year warranty for RoHS compliant products with an extended temperature range
- Input voltage up to 144 VDC
- Single output of 3.3 to 48 VDC
- No input-to-output isolation
- High efficiency up to 97%
- Extremely wide input voltage range
- Low input-to-output differential voltage
- Very good dynamic properties
- Input undervoltage lockout
- Output voltage adjustment and inhibit function
- Continuously no-load and short-circuit proof
- All boards are coated with a protective lacquer

Safety-approved to the latest edition of IEC/EN 60950-1 and UL/CSA 60950-1



### Table of Contents

Description.....	1
Model Selection.....	2
Functional Description.....	5
Electrical Input Data.....	6
Electrical Output Data.....	8
Auxiliary Functions.....	12

Electromagnetic Compatibility (EMC).....	13
Immunity to Environmental Conditions.....	15
Mechanical Data.....	16
Safety and Installation Instructions.....	17
Description of Options.....	19
Accessories.....	21

## Model Selection

Table 1: PSC Series

Output voltage $V_{o,nom}$ [V]	Output current $I_{o,nom}$ [A]	Operating input voltage range $V_i$ [V]	Nom. input voltage $V_{o,nom}$ [V]	Efficiency <sup>2</sup>		Type designation	Options
				$\eta_{min}$ [%]	$\eta_{typ}$ [%]		
5.1	10	8 - 80	40	77.5	79	PSC5A10-9iRG	-7, L, C, D, non-G
5.1	11	8 - 40	20	78	79	PSC5A11-2 <sup>3</sup>	---
5.1	12	7 - 40	20	83.5	85.5	PSC5A12-9iRG	-7, L, P, C, D, non-G
12	6	18 - 144 <sup>1</sup>	60	88	89	PSC126-9iRG	-7, L, C, D, non-G
12	8	15 - 80	40	91	93	PSC128-9iRG	-7, L, P, C, D, non-G
12	9	15 - 40	30	89	90	PSC129-2iR <sup>4</sup>	---
15	6	22 - 144 <sup>1</sup>	60	89	91	PSC156-9iRG	L, C, D,
15	8	19 - 80	40	90	92.5	PSC158-9iRG	-7, L, P, C, D, non-G
15	9	19 - 40	30	91	93.5	PSC159-2iR <sup>5</sup>	---
24	6	31 - 144 <sup>1</sup>	60	93	94	PSC246-9iRG	-7, L, P, C, D, non-G
24	8	29 - 80	40	93	95	PSC248-9iRG	-7, L, P, C, D, non-G
24	9	29 - 60	40	94	96	PSC249-2iR <sup>6</sup>	---
36	6	44 - 144 <sup>1</sup>	80	95	96	PSC366-9iRG	-7, L, P, C, D, non-G
36	8	42 - 80	60	95	96.6	PSC368-9iRG	-7, L, P, C, D, non-G
48	6	58 - 144 <sup>1</sup>	80	96	97	PSC486-9iRG	-7, L, P, C, D, non-G

<sup>1</sup> Surges up to 156 V for 2 s; see *Electrical Input Data*

<sup>2</sup> Efficiency at  $V_{i,nom}$  and  $I_{o,nom}$

<sup>3</sup> Obsolete. Use PSCA12-9iRG !

<sup>4</sup> Obsolete. Use PSC128-9LiRG !

<sup>5</sup> Obsolete. Use PSC158-9LiRG !

<sup>6</sup> Obsolete. Use PSC248-9LiRG !

Table 2: PSL Series

Output voltage $V_{o,nom}$ [V]	Output current $I_{o,nom}$ [A]	Operating input voltage range $V_i$ [V]	Nom. input voltage $V_{o,nom}$ [V]	Efficiency <sup>2</sup>		Type designation	Options
				$\eta_{min}$ [%]	$\eta_{max}$ [%]		
5.1	10	8 - 80	40	77.5	79	PSL5A10-9RG	-7, L, i, C, non-G
5.1	12	7 - 40	20	83.5	85.5	PSL5A12-9RG	-7, L, C, non-G
12	6	18 - 144 <sup>1</sup>	60	88	89	PSL126-9RG	-7, L, C, non-G
12	8	15 - 80	40	89	90	PSL128-9RG	L, C
15	6	22 - 144 <sup>1</sup>	60	89	91	PSL156-9RG	L, C
15	8	19 - 80	40	90	92.5	PSL158-9RG	-7, L, i, C, non-G
24	6	31 - 144 <sup>1</sup>	60	93	94	PSL246-9RG	-7, L, C, non-G
24	8	29 - 80	40	93	95	PSL248-9RG	-7, L, C, K, non-G
36	6	44 - 144 <sup>1</sup>	80	95	96	PSL366-9RG	-7, L, C, non-G
36	8	42 - 80	60	95	96.6	PSL368-9RG	-7, L, C, non-G
48	6	58 - 144 <sup>1</sup>	80	96	97	PSL486-9RG	-7, L, non-G

<sup>1</sup> Surges up to 156 V for 2 s; see *Electrical Input Data*

<sup>2</sup> Efficiency at  $V_{i,nom}$  and  $I_{o,nom}$

 NFND: Not for new designs.

 Preferred for new designs.

### Part Number Description

#### PSC Series

PSC 12 6 -7 L i R P C D G

Positive switching regulator in case C03.....	PSC
Nominal output voltage in volt .....	3.3 to 48
Nominal output current in ampere .....	6 to 12
Operational ambient temperature range $T_A$	
-10 to 50 °C .....	-2
-25 to 71 °C (option) .....	-7
-40 to 71 °C .....	-9
Input filter (option) .....	L
Inhibit input .....	i
Control input for output voltage adjustment <sup>1</sup> .....	R
Potentiometer <sup>1</sup> (option) .....	P
Thyristor crowbar (option) .....	C
Input/output voltage monitor (option).....	D
RoHS-compliant for all 6 substances .....	G

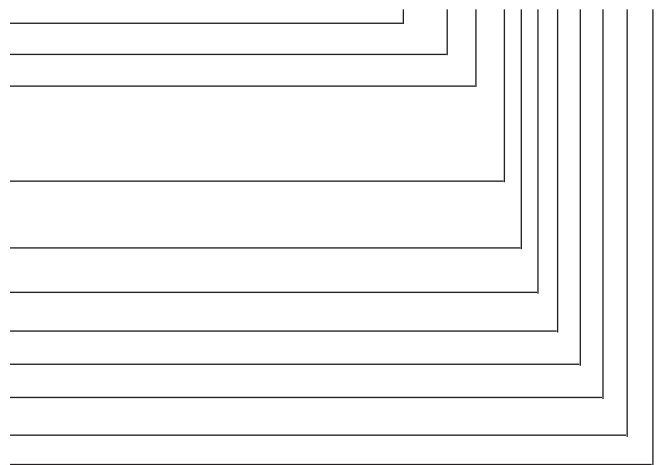

<sup>1</sup> Feature R excludes option P and vice versa.

Example: PSC126-7LiPCG designates a positive switching regulator with a 12 V, 6 A output, ambient temperature range of -25 to 71 °C, input filter, inhibit input, output adjust potentiometer, thyristor crowbar, RoHS-compliant

#### PSL Series

PSL 12 6 -7 L R C K G

Positive switching regulator in case C03.....	PSC
Nominal output voltage in volt .....	5.1 to 48
Nominal output current in ampere .....	6 to 12
Operational ambient temperature range $T_A$	
-10 to 50 °C .....	-2
-25 to 71 °C (option) .....	-7
-40 to 71 °C .....	-9
Input filter (option) .....	L
Inhibit input <sup>1</sup> .....	i
Control input for output voltage adjustment <sup>1</sup> .....	R
Thyristor crowbar (option) .....	C
Coding strip (option) .....	K
RoHS-compliant for all 6 substances .....	G

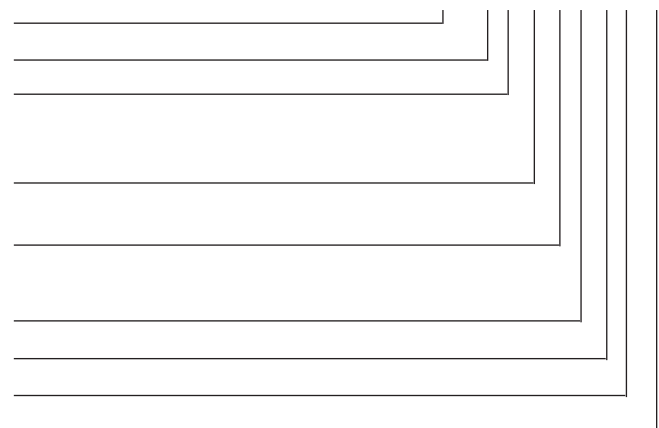

<sup>1</sup> Feature R excludes option i and vice versa.

Example: PSL126-9LRCKG designates a positive switching regulator with a 12 V, 6 A output, ambient temperature range of -40 to 71 °C, input filter, output voltage adjust, and thyristor crowbar, RoHS-compliant.

NFND: Not for new designs.

Preferred for new designs.

### Customer-Specific Models

Positive switching regulator in case C03.....	PSC
Positive switching regulator in case L04 .....	PSL
Nominal output voltage in Volt (without decimals).....	12
Decimal places:	
0.0 V.....	Z
0.1 V.....	A
0.15 V.....	B
0.2 V.....	C
0.25 V.....	D
0.3 V.....	E
0.4 V.....	F
0.5 V.....	G
0.6 V.....	H
0.7 V.....	J
0.8 V.....	K
0.9 V.....	L
other.....	Y
Output current in Amperes .....	3
Identification character .....	A, B, ...
Temperature range and options .....	-9iRG

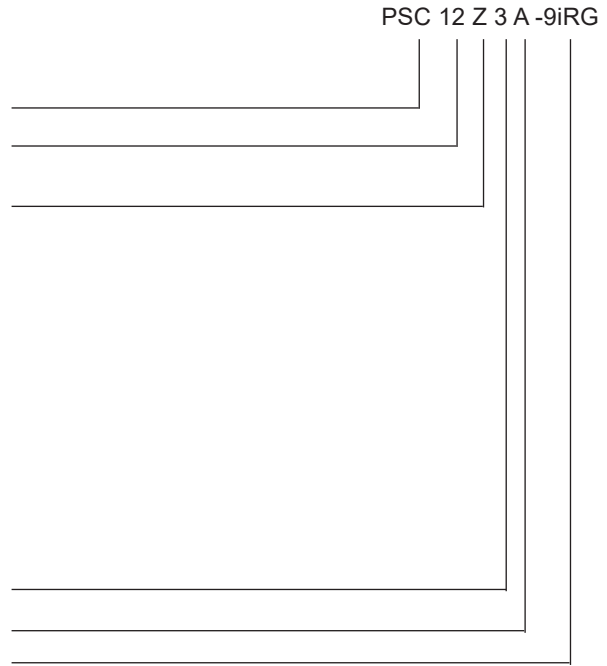

### Product Marking

Type designation, applicable safety approval marks, warnings, pin allocation, patent nos., and company logo.

Identification of LED and optional potentiometers. Label with input voltage range, nominal output voltage and current, protection degree, batch no., serial no., and data code including production site, version (modification status), and date of production.

**Functional Description**

The switching regulators are designed using the buck converter topology. The input is not electrically isolated from the output. During the on period of the switching transistor, current is transferred to the output, and energy is stored in the output choke. During the off period, this energy forces the current to continue flowing through the output, to the load, and back through the freewheeling diode. Regulation is accomplished by varying the duty cycle (on to off ratio) of the power switch. The regulator is equipped with an undervoltage lockout, but no overvoltage shutdown.

These regulators are ideal for a wide range of applications, where input to output isolation is not necessary, or where already provided by an external front end (e.g., a transformer with rectifier). To optimize customer's needs, additional options and accessories are available.

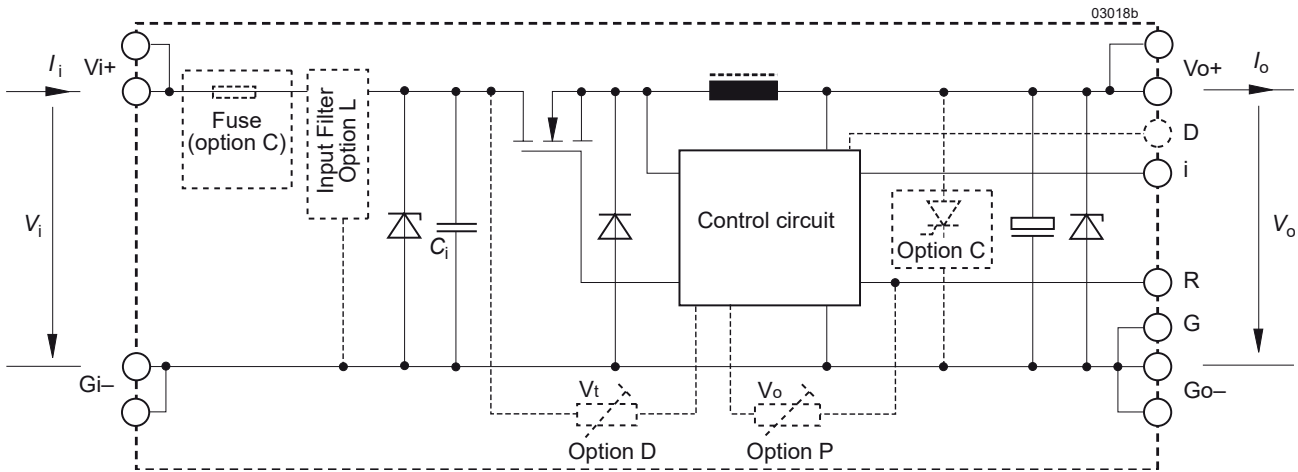

Fig. 1  
Block diagram PSC

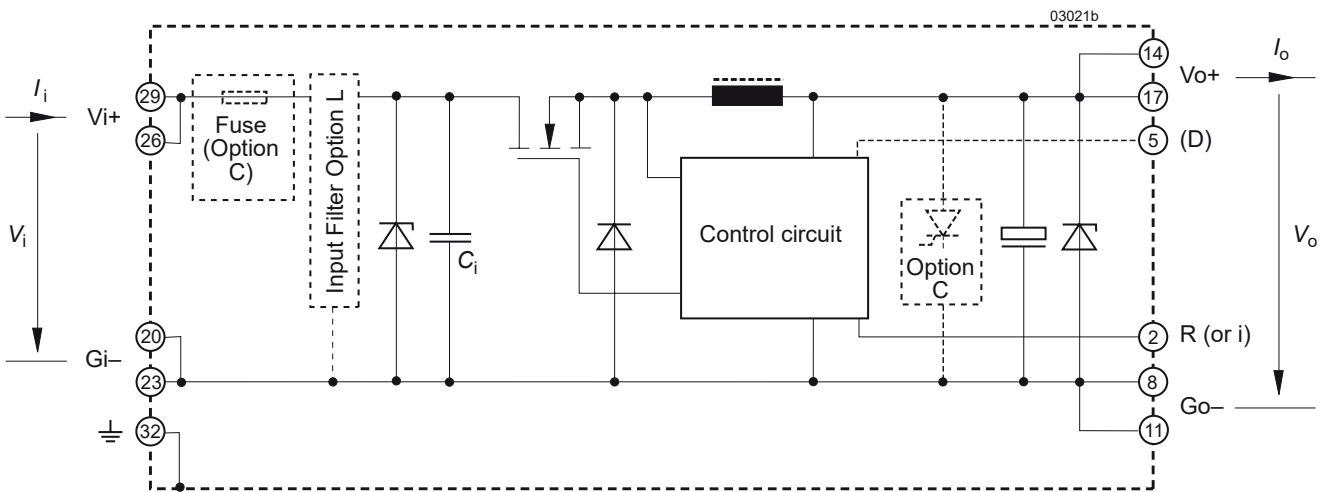

Fig. 2  
Block diagram PSL

## Electrical Input Data

General Conditions:  $T_A = 25\text{ °C}$ , unless  $T_C$  is specified

Table 3a: Input data

Model		PSC5A11-2			PSC129-2			PSC159-2			PSC249-2			Unit	
Characteristics		Conditions		min	typ	max	min	typ	max	min	typ	max	min		typ
$V_i$	Operating input voltage	$I_o = 0 - I_{o,nom}$ $T_{C,min} - T_{C,max}$		8	40		15	40		19	40		29	60	V
$\Delta V_{io,min}$	Min. diff. voltage $V_i - V_o$					2.9		3		4		5			
$V_{i,UVL}$	Undervoltage lockout			7.3		7.3		7.3		12					
$I_o$	No-load input current	$I_o = 0, V_{i,min} - V_{i,max}$			50			50			50			50	mA
$I_{in,p}$	Inrush peak current	$V_{i,nom}$		150			150			250			250		A
$t_{in,r}$	Inrush current rise time	$V_{i,nom}$		5			5			5			5		$\mu$ s
$V_{i,RFI}$	EN 55011, 0.15 - 30 MHz	$V_{i,nom}, I_{o,nom}$		A			A			A			A		Class

Table 3b: Input data

Model		PSC5A12 / PSL5A12			PSC5A10 / PSL5A10			PSC128 / PSL128			Unit		
Characteristics		Conditions		min	typ	max	min	typ	max	min		typ	max
$V_i$	Operating input voltage	$I_o = 0 - I_{o,nom}$ $T_{C,min} - T_{C,max}$		7	40		8	80		15	80		V
$\Delta V_{io,min}$	Min. diff. voltage $V_i - V_o$					1.9		2.9		3			
$V_{i,UVL}$	Undervoltage lockout			6.3		7.3		7.3		7.3			
$I_o$	No-load input current	$I_o = 0, V_{i,min} - V_{i,max}$			45			40			35		mA
$I_{in,p}$	Inrush peak current	$V_{i,nom}$	without opt. L	150			250			250			A
			with opt. L	250			350		350				
$t_{in,r}$	Inrush current rise time	$V_{i,nom}$	without opt. L	5			5			5			$\mu$ s
			with opt. L	25			25		25				
$V_{i,RFI}$	EN 55011, 0.15 - 30 MHz	$V_{i,nom}, I_{o,nom}$			B <sup>1</sup>			B <sup>1</sup>			B <sup>1</sup>		Class

Table 3c: Input data

Model		PSC158 / PSL158			PSC248 / PSL248			PSC368 / PSL368			Unit		
Characteristics		Conditions		min	typ	max	min	typ	max	min		typ	max
$V_i$	Operating input voltage	$I_o = 0 - I_{o,nom}$ $T_{C,min} - T_{C,max}$		19	80		29	80		42	80		V
$\Delta V_{io,min}$	Min. diff. voltage $V_i - V_o$					4		5		6			
$V_{i,UVL}$	Undervoltage lockout			7.3		12		19					
$I_o$	No-load input current	$I_o = 0, V_{i,min} - V_{i,max}$			35			35			40		mA
$I_{in,p}$	Inrush peak current	$V_{i,nom}$	without opt. L	250			250			250			A
			with opt. L	350			350		350				
$t_{in,r}$	Inrush current rise time	$V_{i,nom}$	without opt. L	5			5			5			$\mu$ s
			with opt. L	25			25		25				
$V_{i,RFI}$	EN 55011, 0.15 - 30 MHz	$V_{i,nom}, I_{o,nom}$			B <sup>1</sup>			B <sup>1</sup>			B <sup>1</sup>		Class

<sup>1</sup> With option L and an additional external input cap  $C_{ext} = 120\text{ }\mu\text{F}/100\text{ V}$ , e.g., Nichicon or similar

Table 3d: Input data

Model			PSC126 / PSL126			PSC156 / PSL156			PSC246 / PSL246			Unit
Characteristics		Conditions	min	typ	max	min	typ	max	min	typ	max	
$V_i$	Operating input voltage	$I_o = 0 - I_{o,nom}^1$ $T_{C,min} - T_{C,max}$	18		144 <sup>2</sup>	22		144 <sup>2</sup>	31		144 <sup>2</sup>	V
$\Delta V_{io,min}$	Min. diff. voltage $V_i - V_o$				6			7			7	
$V_{i,UVL}$	Undervoltage lockout				12			15			19	
$I_{i0}$	No-load input current	$I_o = 0, V_{i,min} - V_{i,max}$			35			35			35	mA
$I_{inr,p}$	Inrush peak current	$V_{i,nom}$	without opt. L		250			250			250	A
			with opt. L		350			350			350	
$t_{inr,r}$	Inrush current rise time	$V_{i,nom}$	without opt. L		5			5			5	$\mu$ s
			with opt. L		25			25			25	
$V_{i,RFI}$	EN 55011, 0.15 - 30 MHz	$V_{i,nom}, I_{o,nom}$			B <sup>1</sup>			B <sup>1</sup>			B <sup>1</sup>	Class

Table 3e: Input data

Model			PSC366 / PSL366			PSC486 / PSL486			Unit
Characteristics		Conditions	min	typ	max	min	typ	max	
$V_i$	Operating input voltage	$I_o = 0 - I_{o,nom}^1$ $T_{C,min} - T_{C,max}$	44		144 <sup>2</sup>	58		144 <sup>2</sup>	V
$\Delta V_{io,min}$	Min. diff. voltage $V_i - V_o$				8			10	
$V_{i,UVL}$	Undervoltage lockout				29			40	
$I_{i0}$	No-load input current	$I_o = 0, V_{i,min} - V_{i,max}$			40			45	mA
$I_{inr,p}$	Inrush peak current	$V_{i,nom}$	without opt. L		250			250	A
			with opt. L		350			350	
$t_{inr,r}$	Inrush current rise time	$V_{i,nom}$	without opt. L		5			5	$\mu$ s
			with opt. L		25			25	
$V_{i,RFI}$	EN 55011, 0.15 - 30 MHz	$V_{i,nom}, I_{o,nom}$			B <sup>1</sup>			B <sup>1</sup>	Class

<sup>1</sup> With option L and an additional external input cap  $C_{ext} = 120 \mu F/100 V$ , e.g., Nichicon or similar

<sup>2</sup> Surges up to 156 V for 2 s

### External Input Circuitry

The sum of the lengths of the supply lines to the source or to the nearest capacitor  $\geq 100 \mu F$  (a + b) should not exceed 5 m, unless option L is fitted. This option is recommended in order to prevent power line oscillations and reduce superimposed interference voltages.

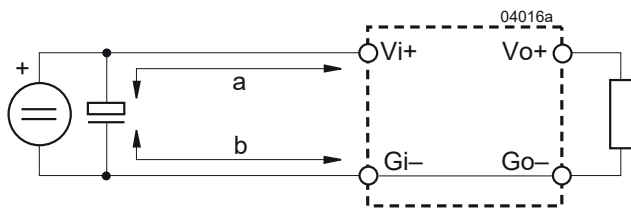
 Fig. 3  
 Switching regulator with long supply lines.

### Electrical Output Data

General conditions:

- $T_A = 25\text{ °C}$ , unless  $T_C$  is specified
- R-input open (or  $V_o$  set to  $V_{o\text{ nom}}$  with option P)

Table 4a: Output data

Output			PSC5A11			PSC129			PSC159			PSC249			Unit	
Characteristics			Conditions			min	typ	max	min	typ	max	min	typ	max		
$V_o$	Output voltage		$V_{i\text{ nom}}, I_{o\text{ nom}}$			5.05	5.15		11.6	12.4		14.5	15.5	23.3	24.7	V
$I_o$	Output current		$V_{i\text{ min}} - V_{i\text{ max}}$			0		11.0	0		9.0	0		9.0	0	A
$I_{oL}$	Output current limitation		$T_{C\text{ min}} - T_{C\text{ max}}$			11.0		14.3	9.0		11.7	9.0		11.7	9.0	
$V_o$	Output voltage noise	Switching frequency	$V_{i\text{ nom}}, I_{o\text{ nom}}$ IEC/EN 61204					55			150			200		mV <sub>pp</sub>
		Total	BW = 20 MHz					60			160			210		
$\Delta V_{oV}$	Static line regulation		$V_{i\text{ min}} - V_{i\text{ max}}, I_{o\text{ nom}}$					100			240			300		mV
$\Delta V_{oI}$	Static load regulation		$V_{i\text{ nom}}, I_o = 0 - I_{o\text{ nom}}$					100			120			150		
$V_{oD}$	Dynamic load regulation	Voltage deviation	$V_{i\text{ nom}}$ $I_{o\text{ nom}} \leftrightarrow 1/3 I_{o\text{ nom}}$					130			360			450		μs
$t_d$		Recovery time	IEC/EN 61204					50			60			60		
$\alpha_{V_o}$	Temperature coefficient $\Delta V_o / \Delta T_C (T_{C\text{ min}} - T_{C\text{ max}})$		$V_{i\text{ min}} - V_{i\text{ max}}$ $I_o = 0 - I_{o\text{ nom}}$					±0.02			±0.02			±0.02		%/K

Table 4b: Output data

Output			PSC5A12 / PSL5A12			PSC5A10 / PSL5A10			PSC128 / PSL128			Unit			
Characteristics			Conditions			min	typ	max	min	typ	max		min	typ	max
$V_o$	Output voltage		$V_{i\text{ nom}}, I_{o\text{ nom}}$			5.07		5.13	5.07		5.13	11.93		12.07	V
$I_o$	Output current		$V_{i\text{ min}} - V_{i\text{ max}}$			0		12.0	0		11.0	0		9.0	A
$I_{oL}$	Output current limitation		$T_{C\text{ min}} - T_{C\text{ max}}$			12.0		15.6	11.0		14.3	9.0		11.7	
$V_o$	Output voltage noise	Switching frequency	$V_{i\text{ nom}}, I_{o\text{ nom}}$ IEC/EN 61204					55			55			150	mV <sub>pp</sub>
		Total	BW = 20 MHz					60			60			160	
$\Delta V_{oV}$	Static line regulation		$V_{i\text{ min}} - V_{i\text{ max}}, I_{o\text{ nom}}$					100			100			240	mV
$\Delta V_{oI}$	Static load regulation		$V_{i\text{ nom}}, I_o = 0 - I_{o\text{ nom}}$					100			100			120	
$V_{oD}$	Dynamic load regulation	Voltage deviation	$V_{i\text{ nom}}$ $I_{o\text{ nom}} \leftrightarrow 1/3 I_{o\text{ nom}}$					150			130			360	μs
$t_d$		Recovery time	IEC/EN 61204					50			50			60	
$\alpha_{V_o}$	Temperature coefficient $\Delta V_o / \Delta T_C (T_{C\text{ min}} - T_{C\text{ max}})$		$V_{i\text{ min}} - V_{i\text{ max}}$ $I_o = 0 - I_{o\text{ nom}}$					±0.02			±0.02			±0.02	%/K



Table 4c: Output data. General conditions as per table 4a

Output			PSC158 / PSL158			PSC248 / PSL248			PSC368 / PSL368			Unit
Characteristics		Conditions	min	typ	max	min	typ	max	min	typ	max	
$V_o$	Output voltage	$V_{i\text{nom}}, I_{o\text{nom}}$	14.91		15.09	23.68		24.14	35.78		36.22	V
$I_o$	Output current	$V_{i\text{min}} - V_{i\text{max}}$	0		8.0	0		8.0	0		8.0	A
$I_{oL}$	Output current limitation	$T_{C\text{min}} - T_{C\text{max}}$	8.0		10.4	8.0		10.4	8.0		10.4	
$V_o$	Output voltage noise	Switching frequency	$V_{i\text{nom}}, I_{o\text{nom}}$ IEC/EN 61204	50	90	55	150	80	190			mV <sub>pp</sub>
		Total	BW = 20 MHz	54	94	60	155	85	195			
$\Delta V_{oV}$	Static line regulation	$V_{i\text{min}} - V_{i\text{max}}, I_{o\text{nom}}$		70	100	150	220	200	270			mV
$\Delta V_{oI}$	Static load regulation	$V_{i\text{nom}}, I_o = 0 - I_{o\text{nom}}$		30	45	120	160	125	160			
$V_{od}$	Dynamic load regulation	Voltage deviation	$V_{i\text{nom}}$ $I_{o\text{nom}} \leftrightarrow 1/3 I_{o\text{nom}}$	130		150		220				
$t_d$		Recovery time	IEC/EN 61204	60		80		100			$\mu\text{s}$	
$\alpha_{Vo}$	Temperature coefficient $\Delta V_o / \Delta T_C (T_{C\text{min}} - T_{C\text{max}})$	$V_{i\text{min}} - V_{i\text{max}}$ $I_o = 0 - I_{o\text{nom}}$			$\pm 0.02$			$\pm 0.02$			$\pm 0.02$	%/K

Table 4d: Output data. General conditions as per table 4a

Output			PSC126 / PSL126			PSC156 / PSL156			PSC246 / PSL246			Unit
Characteristics		Conditions	min	typ	max	min	typ	max	min	typ	max	
$V_o$	Output voltage	$V_{i\text{nom}}, I_{o\text{nom}}$	11.93		12.07	14.91		15.09	23.86		24.14	V
$I_o$	Output current	$V_{i\text{min}} - V_{i\text{max}}$	0		6.0	0		6.0	0		6.0	A
$I_{oL}$	Output current limitation	$T_{C\text{min}} - T_{C\text{max}}$	6.0		7.8	6.0		7.8	6.0		7.8	
$V_o$	Output voltage noise	Switching frequency	$V_{i\text{nom}}, I_{o\text{nom}}$ IEC/EN 61204	30	45	50	70	50	70			mV <sub>pp</sub>
		Total	BW = 20 MHz	34	49	54	74	54	75			
$\Delta V_{oV}$	Static line regulation	$V_{i\text{min}} - V_{i\text{max}}, I_{o\text{nom}}$		25	40	25	40	80	100			mV
$\Delta V_{oI}$	Static load regulation	$V_{i\text{nom}}, I_o = 0 - I_{o\text{nom}}$		60		60		80				
$V_{od}$	Dynamic load regulation	Voltage deviation	$V_{i\text{nom}}$ $I_{o\text{nom}} \leftrightarrow 1/3 I_{o\text{nom}}$	150		130		360				
$t_d$		Recovery time	IEC/EN 61204	50		50		60			$\mu\text{s}$	
$\alpha_{Vo}$	Temperature coefficient $\Delta V_o / \Delta T_C (T_{C\text{min}} - T_{C\text{max}})$	$V_{i\text{min}} - V_{i\text{max}}$ $I_o = 0 - I_{o\text{nom}}$			$\pm 0.02$			$\pm 0.02$			$\pm 0.02$	%/K

Table 4e: Output data. General conditions as per table 4a

Output		PSC366 / PSL366			PSC486 / PSL486			Unit	
Characteristics	Conditions	min	typ	max	min	typ	max		
$V_o$	Output voltage	$V_{i\text{nom}}, I_{o\text{nom}}$		35.78	36.22	47.71	48.29	V	
$I_{o\text{nom}}$	Output current	$V_{i\text{min}} - V_{i\text{max}}$		0	6.0	0	6.0	A	
$I_{oL}$	Output current limitation	$T_{C\text{min}} - T_{C\text{max}}$		6.0	7.8	6.0	7.8		
$V_o$	Output voltage noise	Switching frequency	$V_{i\text{nom}}, I_{o\text{nom}}$ IEC/EN 61204		50	90	55	110	mV <sub>pp</sub>
		Total	BW = 20 MHz		54	94	95	115	
$\Delta V_{oV}$	Static line regulation	$V_{i\text{min}} - V_{i\text{max}}, I_{o\text{nom}}$		200	300	100	200	mV	
$\Delta V_{oI}$	Static load regulation	$V_{i\text{nom}}, I_o = 0 - I_{o\text{nom}}$		120	200	180	250		
$V_{od}$	Dynamic load regulation	Voltage deviation	$V_{i\text{nom}}$ $I_{o\text{nom}} \leftrightarrow 1/3 I_{o\text{nom}}$		140		150		
$t_d$		Recovery time	IEC/EN 61204		100		100	$\mu\text{s}$	
$\alpha_{Vo}$	Temperature coefficient $\Delta V_o / \Delta T_C (T_{C\text{min}} - T_{C\text{max}})$	$V_{i\text{min}} - V_{i\text{max}}$ $I_o = 0 - I_{o\text{nom}}$			$\pm 0.02$		$\pm 0.02$	%/K	

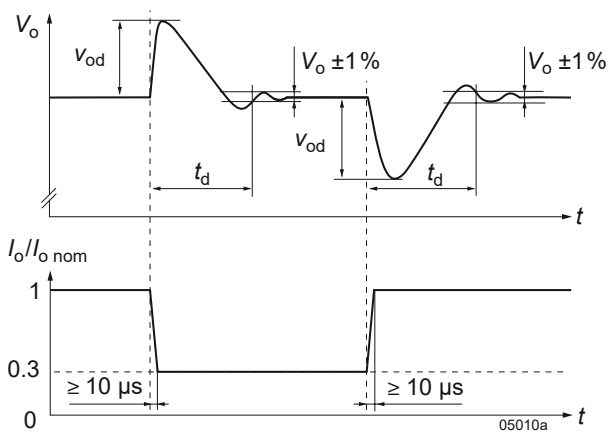

Fig. 4  
Switching regulator with long supply lines.

**Thermal Considerations**

When a switching regulator is located in free, quasi-stationary air (convection cooling) at a temperature  $T_A = 71\text{ °C}$  and is operated at  $I_{o,nom}$ , the case temperature  $T_C$  will be about  $95\text{ °C}$  after the warm-up phase, measured at the measuring point of case temperature  $T_C$ ; see *Mechanical Data*.

Under practical operating conditions, the ambient temperature  $T_A$  may exceed  $71\text{ °C}$ , provided that additional measures (heat sink, fan, etc.) are taken to ensure that the case temperature  $T_C$  does not exceed its maximum value of  $95\text{ °C}$ .

Example: Sufficient forced cooling allows  $T_{A,max} = 85\text{ °C}$ . A simple check of the case temperature  $T_C$  ( $T_C \leq 95\text{ °C}$ ) at full load ensures correct operation of the system.

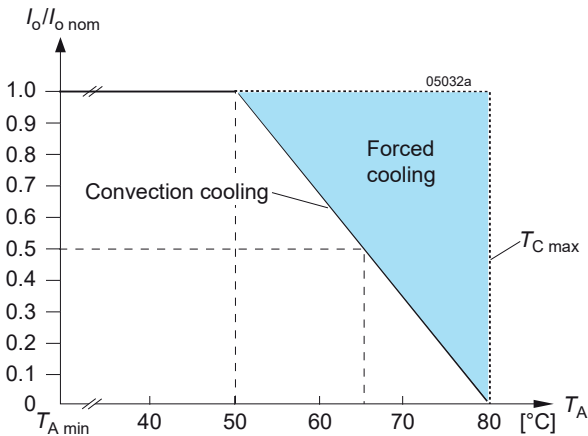

Fig. 5a  
Output current derating vs. temperature (models -2)

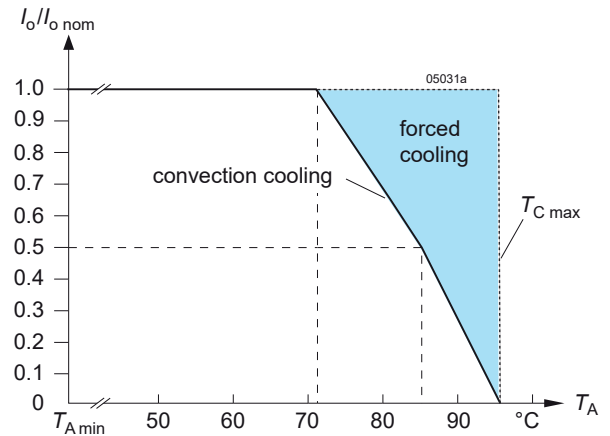

Fig. 5b  
Output current derating vs. temperature (models -7 and -9)

**Output Protection and Short Circuit Behaviour**

A voltage suppressor diode, which in worst case conditions fails into a short circuit (or a thyristor crowbar, option C), protects the output against an internally generated over-voltage. Such an overvoltage could occur due to a failure of either the control circuit or the switching transistor. The output protection is not designed to withstand externally applied overvoltages.

A constant current limitation circuit holds the output current almost constant, when an overload or a short circuit is applied to the output. It acts self-protecting and recovers automatically after removal of the overload or short circuit condition.

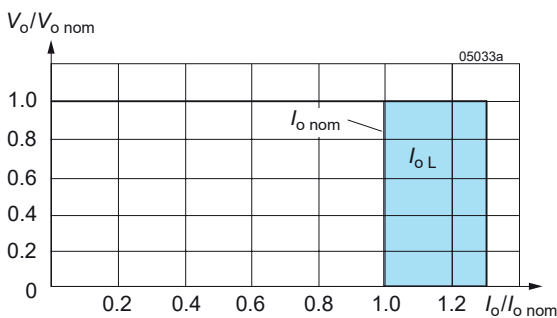

Fig. 6  
Overload, short-circuit behaviour  $V_o$  versus  $I_o$ .

**Parallel and Series Connection**

Outputs of equal nominal voltages can be parallel-connected. However, the use of a single regulator with higher output power, is always the better solution.

In parallel-connected operation, one or several outputs may operate continuously at their current limit knee-point which will cause an increase of the heat generation. Consequently, the max. ambient temperature should be reduced by  $10\text{ °C}$ .

Outputs can be series-connected with any other regulator. In series-connection the maximum output current is limited by the lowest current limitation, but electrically separated source voltages are needed for each regulator.

## Auxiliary Functions

### i Inhibit (Remote On / Off)

The inhibit input allows the switching regulator output to be disabled via a control signal. In systems with several converters, this feature can be used, for example, to control the activation sequence of the converters by a logic signal (TTL, C-MOS, etc.). An output voltage overshoot will not occur, when switching on or off.

**Note:** With open i-input, the output is enabled.

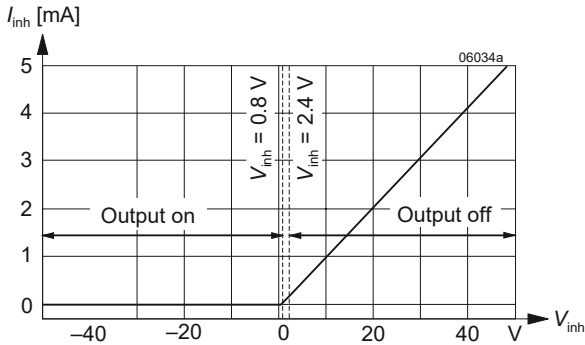

Fig. 7  
Typical inhibit current  $I_{inh}$  versus inhibit voltage  $V_{inh}$

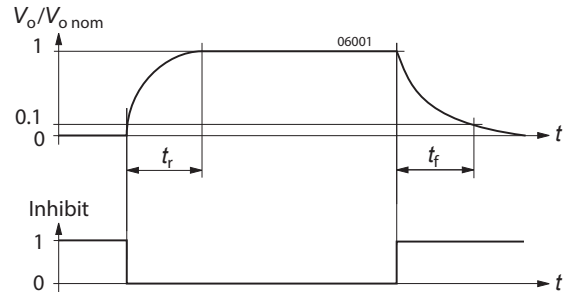

Fig. 8  
Output response as a function of inhibit signal

Table 4: Inhibit characteristics

Characteristics		Conditions	min	typ	max	Unit
$V_{inh}$	Inhibit input voltage	$V_o = \text{on}$	-50		+0.8	V
		$V_o = \text{off}$	+2.4		+50	
$t_r$	Switch-on time	$V_i = V_{i,nom}$		130		ms
$t_f$	Switch-off time	$R_L = V_{o,nom} / I_{o,nom}$		25		
$I_{inh}$	Input current when inhibited	$V_i = V_{i,nom}$		25		mA

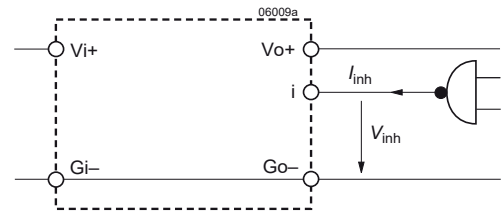

Fig. 89  
Definition of  $I_{inh}$  and  $V_{inh}$

### R Output Voltage Adjust

**Note:** With open R input,  $V_o \approx V_{o,nom}$ .

The output voltage  $V_o$  can either be adjusted with an external voltage source ( $V_{ext}$ ) or with an external resistor ( $R_{ext1}$  or  $R_{ext2}$ ). The adjustment range is 0 – 108% of  $V_{o,nom}$ . The minimum differential voltage  $\Delta V_{io,min}$  between input and output (see *Electrical Input Data*) should be maintained.

a)  $V_o = 0 - V_{o,max}$ , using  $V_{ext}$  between R and G (Go- for PSL):

$$V_{ext} \approx 2.5 \text{ V} \cdot \frac{V_o}{V_{o,nom}} \quad V_o \approx V_{o,nom} \cdot \frac{V_{ext}}{2.5 \text{ V}}$$

**Caution:** To prevent damage,  $V_{ext}$  should not exceed 20 V, nor be negative.

b)  $V_o = 0$  to  $V_{o,nom}$ , using  $R_{ext1}$  between R and G (Go- for PSL):

$$R_{ext1} \approx \frac{4000 \Omega \cdot V_o}{V_{o,nom} - V_o} \quad V_o \approx \frac{V_{o,nom} \cdot R_{ext1}}{R_{ext1} + 4000 \Omega}$$

c)  $V_o = V_{o,nom}$  to  $V_{o,max}$ , using  $R_{ext2}$  between R and G (Go- for PSL):

$$R_{ext2} \approx \frac{4000 \Omega \cdot V_o \cdot (V_{o,nom} - 2.5 \text{ V})}{2.5 \text{ V} \cdot (V_o - V_{o,nom})}$$

$$V_o \approx \frac{V_{o,nom} \cdot 2.5 \text{ V} \cdot R_{ext2}}{2.5 \text{ V} \cdot (R_{ext2} + 4000 \Omega) - V_{o,nom} \cdot 4000 \Omega}$$

**Caution:** To prevent damage,  $R_{ext2}$  should never be less than 47 k $\Omega$

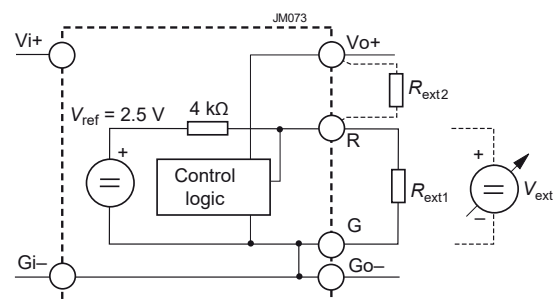

Fig. 10  
Voltage adjustment via R-input

### LED Output Voltage Indicator

An LED indicator (yellow for PSC, green for PSL) is illuminated, when the output voltage is higher than approx. 3 V.

## Electromagnetic Compatibility (EMC)

### Electromagnetic Immunity

Table 6: Electromagnetic immunity type tests

Phenomenon	Standard	Level	Coupling mode	Value applied	Waveform	Source imped.	Test procedure	In oper.	Perf. crit. <sup>2</sup>
Voltage surge <sup>3</sup>	IEC 60571-1	3	i/c, +i/-i	800 V <sub>p</sub>	100 μs	100 Ω	1 positive and 1 negative surge per coupling mode	yes	B
				1500 V <sub>p</sub>	50 μs				
				3000 V <sub>p</sub>	5 μs				
				4000 V <sub>p</sub>	1 μs				
				7000 V <sub>p</sub>	100 ns				
Electrostatic discharge	IEC/EN 61000-4-2	4 <sup>3</sup>	contact discharge to case	8000 V <sub>p</sub> <sup>3</sup>	1/50 ns	330 Ω	10 pos. & 10 neg. discharges	yes	A <sup>5</sup>
		2 <sup>4</sup>		4000 V <sub>p</sub> <sup>4</sup>					
Electromagnetic field	IEC/EN 61000-4-3	3 <sup>3</sup>	antenna	10 V/m <sup>3</sup>	AM 80% / 1 kHz	N/A	80 – 1000 MHz	yes	A
		2 <sup>4</sup>		3 V/m <sup>4</sup>					
Electrical fast transients / burst	IEC/EN 61000-4-4	3	i/c, +i/-i	2000 V <sub>p</sub>	bursts of 5/50 ns; 5 kHz repet. rate; transients with 15 ms burst duration; 300 ms period	50 Ω	60 s positive 60 s negative transients per coupling mode	yes	A <sup>5</sup> B <sup>4</sup>
Surges	IEC/EN 61000-4-5	2 <sup>3</sup>	i/c	1000 V <sub>p</sub>	1.2 / 50 μs	12 Ω 9 μF	5 pos. & 5 neg. surges per coupling mode	yes	B <sup>5</sup>
			+i/-i	500 V <sub>p</sub>					
Conducted disturbances	IEC/EN 61000-4-6	3 <sup>3</sup>	i, o, signal wires	10 VAC <sup>3</sup>	AM 80% / 1 kHz	150 Ω	0.15 – 80 MHz	yes	A
		2 <sup>4</sup>		3 VAC <sup>4</sup>					

<sup>1</sup> i = input, o = output, c = case.

<sup>2</sup> A = Normal operation, no deviation from specifications, B = Normal operation, temporary loss of function or deviation from specs possible

<sup>3</sup> Not applicable for -2 models

<sup>4</sup> Valid for -2 models

<sup>5</sup> Option L necessary; with option C, manual reset might be necessary.

### Electromagnetic Emission

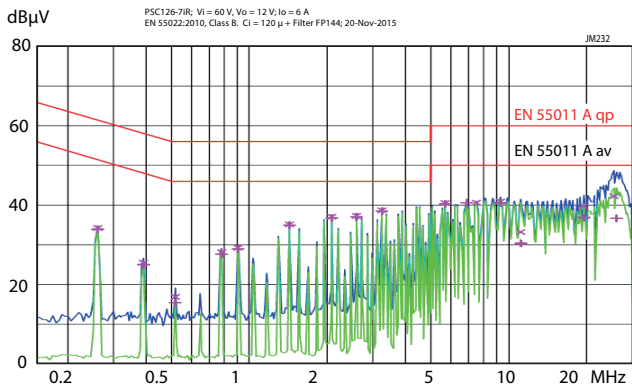

**Fig. 11a**  
**PSC126-7iR: Conducted disturbances at the input as per EN 55011, at  $V_i = 60\text{ V}$ ,  $V_o = 12\text{ V}$ ,  $I_o = 6\text{ A}$ . External  $C_i = 120\text{ }\mu\text{F}$  + Filter FP144.**

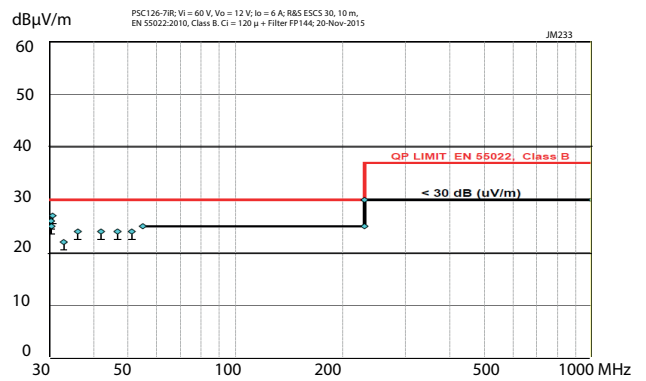

**Fig. 11b**  
**PSC126-7iR: Radiated disturbances in 10 m distance, as per EN 55011, at  $V_i = 60\text{ V}$ ,  $V_o = 12\text{ V}$ ,  $I_o = 6\text{ A}$ .**

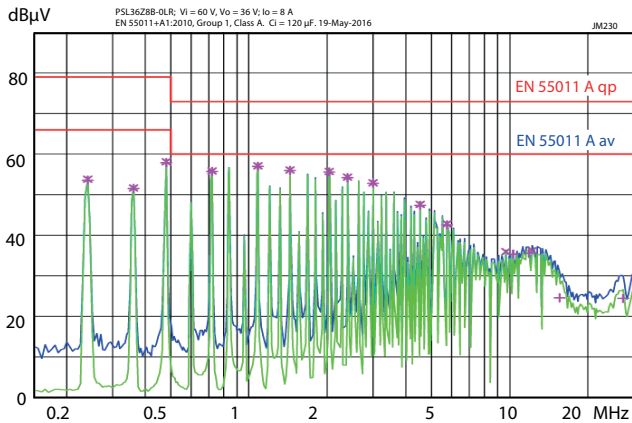

**Fig. 12a**  
**PSL36Z8B: Conducted disturbances at the input according to EN 55011, group 1, class A, at  $V_i = 60\text{ V}$ ,  $V_o = 12\text{ V}$ ,  $I_o = 8\text{ A}$ ; external  $C_{ext} = 120\text{ }\mu\text{F}$ .**

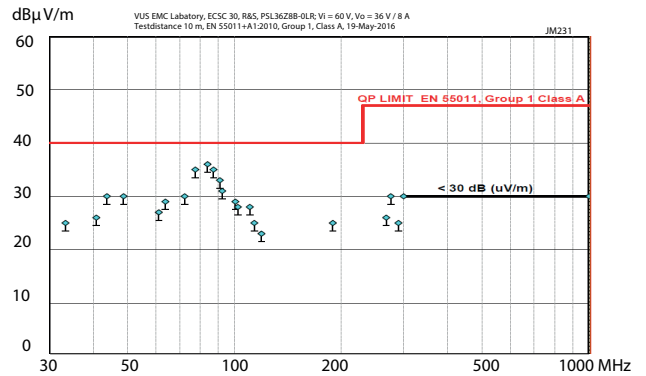

**Fig. 12b**  
**PSL36Z8B: Radiated disturbances in 10 m distance, according to EN 55011, at  $V_i = 60\text{ V}$ ,  $V_o = 12\text{ V}$ ,  $I_o = 8\text{ A}$ ; external  $C_{ext} = 120\text{ }\mu\text{F}$ .**

## Immunity to Environmental Conditions

Table 7: Mechanical and climatic stress

Test method		Standard	Test Conditions		Status
Cab	Damp heat steady state	IEC/EN 60068-2-78 MIL-STD-810D section 507.2	Temperature:	40 ±2 °C	Regulator not operating
			Relative humidity:	93 ±2/-3 %	
			Duration:	56 days	
Ea	Shock (half-sinusoidal)	IEC/EN 60068-2-27 MIL-STD-810D section 516.3	Acceleration amplitude:	50 g <sub>n</sub> = 490 m/s <sup>2</sup>	Regulator operating
			Bump duration:	11 ms	
			Number of bumps:	18 (3 in each direction)	
Fc	Vibration (sinusoidal)	IEC/EN 60068-2-6 MIL-STD-810D section 514.3	Acceleration amplitude:	0.35 mm (10 – 60 Hz)	Regulator operating
				5 g <sub>n</sub> = 49 m/s <sup>2</sup> (60 - 2000 Hz)	
			Frequency (1 Oct/min):	10 – 2000 Hz	
			Test duration:	7.5 h (2.5 h in each axis)	
Fda	Random vibration wide band Reproducibility high	IEC/EN 60068-2-35 DIN 40046 part 23	Acceleration spectral density:	0.05 g <sub>n</sub> <sup>2</sup> /Hz	Regulator operating
			Frequency band:	20 to 500 Hz	
			Acceleration magnitude:	4.9 g <sub>n rms</sub>	
			Test duration:	3 h (1 h in each axis)	
Kb	Salt mist cyclic (sodium chloride NaCl solution)	IEC/EN 60068-2-52	Concentration:	5 % (30 °C)	Regulator not operating
			Duration:	2 h per cycle	
			Storage:	40 °C, 93% rel. humidity	
			Storage duration:	22 h per cycle	
			Number of cycles:	3	

## Temperatures

Table 8: Temperature specifications, valid for air pressure of 800 to 1200 hPa (800 to 1200 mbar)

Temperature			-2			-7 (Option)			-9			Unit
Characteristics		Conditions	min	typ	max	min	typ	max	min	typ	max	
T <sub>A</sub>	Ambient temperature <sup>1</sup>	Regulator operating	- 10		50	- 25		71	- 40		71	° C
T <sub>C</sub>	Case temperature		- 10		80	- 25		95	- 40		95	
T <sub>S</sub>	Storage temperature <sup>1</sup>	Not operational	- 25		100	- 40		100	- 55		85	

<sup>1</sup> See *Thermal Considerations and Overtemperature Protection*.

## Reliability

Table 9: Typical MTBF and device hours

MTBF	Ground benign	Ground fixed		Ground mobile	Device hours <sup>1</sup>
Case temperature	T <sub>c</sub> = 40 °C	T <sub>c</sub> = 40 °C	T <sub>c</sub> = 70 °C	T <sub>c</sub> = 50 °C	
MTBF accord. to MIL-HDBK-217F	660 000 h	143 000 h	81 000 h	68 000 h	2 800 000 h

<sup>1</sup> Statistical values, based on an average of 4300 working hours per year and in general field use

**Mechanical Data**

**PSC models**

Dimensions in mm.

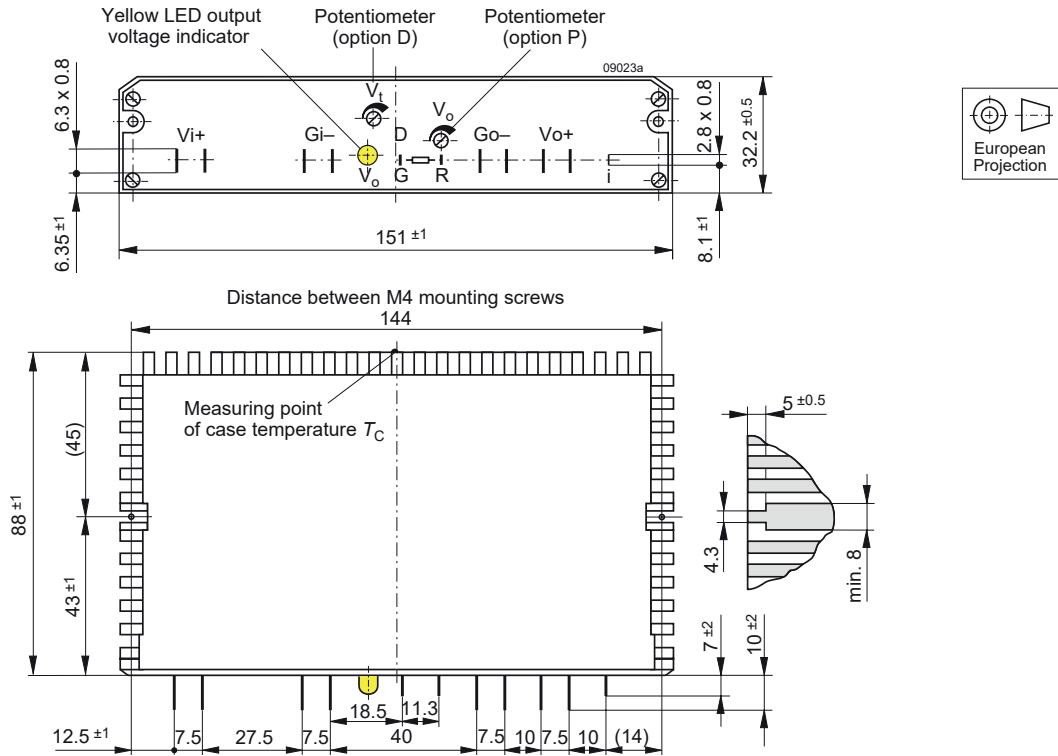

Fig. 13  
Case C03, weight 440 g; Aluminium, black finish and self cooling

**PSL models**

The regulators are designed to be inserted into a DIN-rack according to IEC 60297-3. Dimensions in mm.

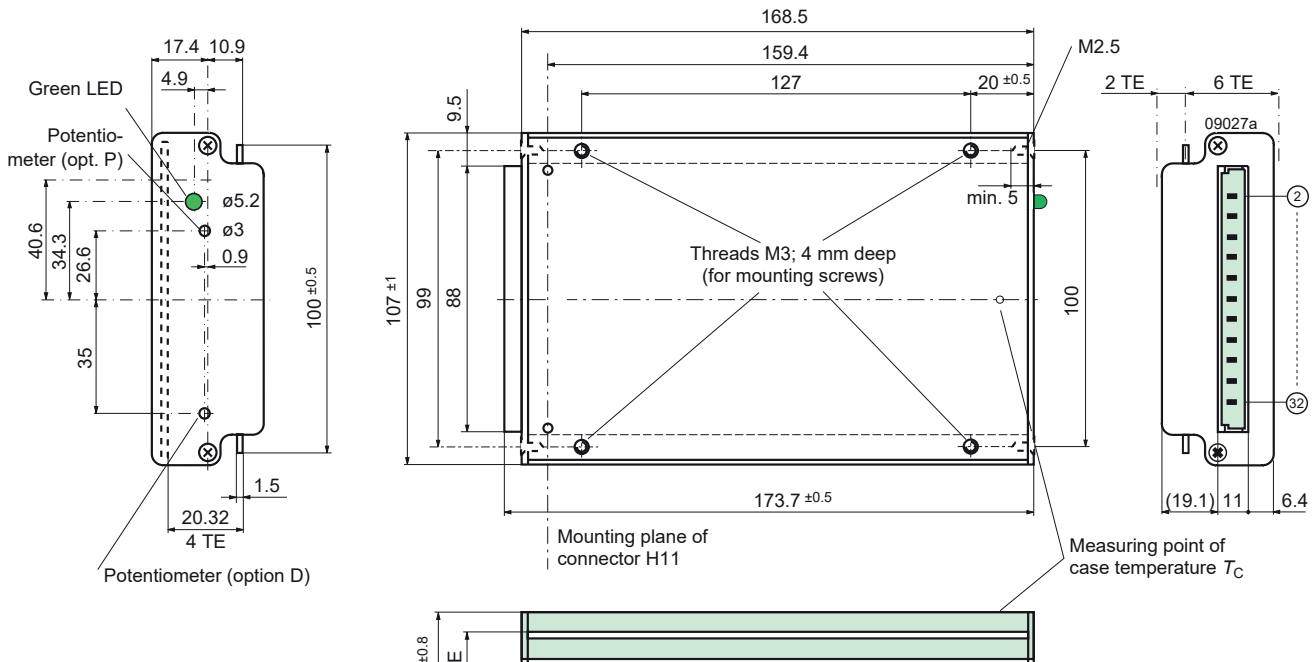

Fig. 14  
Case L04, weight 550 g; Aluminium, fully enclosed, black finish EP powder-coated, and self cooling



## Safety and Installation Instructions

### Pin Allocation

The pins of PSC models are printed onto the case of the regulator.

The pin allocation of PSL models is shown in the table below:

Table 10: H11 connector pin allocation (PSL models)

Electrical Determination	Type H11	
	Pin No.	Design.
R-input (or inhibit input) <sup>1</sup>	2	R (i)
Undervoltage monitor (Option D)	5	D
Output voltage (negative)	8	Go-
Output voltage (negative)	11	Go-
Output voltage (positive)	14	Vo+
Output voltage (positive)	17	Vo+
Input voltage (negative)	20	Gi-
Input voltage (negative)	23	Gi-
Input voltage (positive)	26	Vi+
Input voltage (positive)	29	Vi+
Protective earth PE (leading pin)	32	

<sup>1</sup> R-input is used for the inhibit function. Consequently, option R and i exclude each other.

### Installation Instruction

Installation must strictly follow the national safety regulations in compliance with the enclosure, mounting, creepage, clearance, casualty, markings, and segregation requirements of the end-use application.

Check for hazardous voltages before connecting. Connections of PSC models can be made using fast-on or soldering technique. PSL models should be plugged into a DIN-rack

The input and the output circuit are not separated, i.e., the negative path is internally interconnected.

The regulators should be connected to a secondary circuit.

Do not open the regulator !

Ensure that a unit failure (e.g., by an internal short-circuit) does not result in a hazardous condition.

### Cleaning Liquids

In order to avoid possible damage, any penetration of cleaning fluids must be prevented, since the power supplies are not hermetically sealed.

### Protection Degree

The protection degree is IP 30 (IP 20, if equipped with option P, D, or D1 and for PSC models). It applies only, if the regulator is plugged-in or the matching female connector is properly attached.

### Standards and Approvals

All switching regulators have been approved according to the latest edition of IEC/EN 60950-1 and UL/CSA60950-1.

The regulators have been evaluated for:

- Building in
- The use in a pollution degree 2 environment
- Connecting the input to a secondary circuit, which is subject to a maximum transient rating of 1500 V.

The switching regulators are subject to manufacturing surveillance in accordance with the above mentioned standards and with ISO 9001:2015.

### Isolation

The resistance of the protective earth connection (max. 0.1  $\Omega$ ) is tested only for PSL models.

PSC models: Electric strength test voltage between input connected with output against case: 2200 VDC,  $\geq 1$  s (for some PSC models only with version V103 or higher).

PSL models: The electric strength between the input, interconnected with the output, and the case is tested with 500 VDC (all -2 models), 750 VDC (models with  $V_{i\max} = 80$  V), or 1500 VDC (models with  $V_{i\max} = 144$ ) during  $\geq 1$  s.

These tests are performed in the factory as routine test in accordance with EN 50514 and IEC/EN 60950. The electric strength test should not be repeated by the customer.

### Railway Application

The regulators have been developed observing the railway standards EN 50155 and EN 50121. All boards are coated with a protective lacquer.

## Description of Options

### -7 Temperature Range

This option defines restricted temperature range as specified in table 8 (not for new designs).

### P Potentiometer

**Note:** Option P is not recommended for new designs and not for several regulators operating in parallel connection.

Option P excludes the R function; the R-input (pin 16) should be left open-circuit. The output voltage  $V_o$  can be adjusted in the range 90 – 110% of  $V_{o\text{ nom}}$ .

However, the minimum differential voltage  $\Delta V_{i\text{ o min}}$  between input and output specified in *Electrical Input Data* should be respected.

### L Input Filter

Option L is recommended to reduce superimposed interference voltages and to prevent oscillations, if input lines exceed the length of approx. 5 m in total. The fundamental wave (approx. 120 kHz) of the reduced interference voltage between  $V_i+$  and  $G_i-$  has, with an input line inductance of 5  $\mu\text{H}$ , a maximum magnitude of 4 mVAC.

The input impedance of the switching regulator at 120 kHz is about 3.5  $\Omega$ . The harmonics are small in comparison with the fundamental wave.

With option L, the maximum permissible additionally superimposed ripple  $v_i$  of the input voltage (rectifier mode) at a specified input frequency  $f_i$  has the following values:

$$V_{i\text{ max}} = 10 V_{pp} \text{ at } 100 \text{ Hz or } V_{pp} = 1000 \text{ Hz}/f_i \cdot 1V$$

### C Thyristor Crowbar

Option C protects the load against power supply malfunction. It is not designed to sink external currents. A fixed-value monitoring circuit checks the output voltage  $V_o$ . When the trigger voltage  $V_{o\text{ c}}$  is reached, the thyristor crowbar triggers and disables the output. It can be deactivated by removal of the input voltage. In case of a defect switching transistor, the internal fuse prevents excessive current.

Type of the fuse:

- Regulators with  $I_{o\text{ nom}} = 6 \text{ A}$ : 6.3 A / 250 V, slow, 5 x 20 mm
- Regulators with  $I_{o\text{ nom}} > 6 \text{ A}$ : 16 A / 250 V, slow, 5 x 20 mm

**Note:** The crowbar can be reset by removal of the input voltage only. The inhibit signal cannot deactivate the thyristor.

Table 11: Crowbar trigger levels

Characteristics		Conditions	$V_o = 5.1 \text{ V}$			$V_o = 12 \text{ V}$			$V_o = 15 \text{ V}$			$V_o = 24 \text{ V}$			$V_o = 36 \text{ V}$			Unit
			min	typ	max	min	typ	max	min	typ	max	min	typ	max	min	typ	max	
$V_{o\text{ c}}$	Trigger voltage	$T_{c\text{ min}} - T_{c\text{ max}}$	5.8	6.8		13.5	16		16.5	19		27	31		40	45		V
$t_s$	Delay time	$V_{i\text{ min}} - V_{i\text{ max}}$ $I_o = 0 - I_{o\text{ nom}}$		1.5			1.5			1.5			1.5			1.5		$\mu\text{s}$

### D Input Undervoltage Monitor

Terminal D and  $G_o-$  are connected to a normally conducting field effect transistor (JFET). A 0.5 W Zener diode protects against overvoltages.

The switching characteristics of the option D output are shown in fig. 16.

The voltage  $V_t$  can be externally adjusted by a trim potentiometer. The hysteresis  $V_H$  of  $V_t$  is <2%. Pin D stays low for a minimum time  $t_{\text{low min}}$ , in order to prevent any oscillation.  $V_t$  can be set to a value between  $V_{i\text{ min}}$  and  $V_{i\text{ max}}$ . Note that the JFET becomes conductive, when  $V_D$  exceeds approx. 7 V.

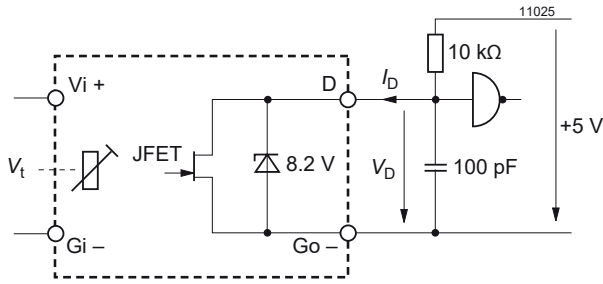

Fig. 15  
Test circuit with definition of voltage  $V_D$  and current  $I_D$

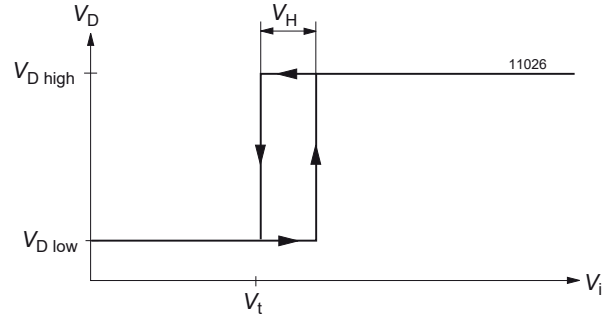

Fig. 16  
Definition of  $V_t$  and  $V_H$

Table 12: Data of option D

Characteristics		Conditions	PSC / PSL			Unit
			min	typ	max	
$V_{D,low}$	Low impedance	$V_i < V_t, I_D \leq 2.5 \text{ mA}$			0.8	V
$V_{D,high}$	High impedance	$V_i > V_t + V_H, I_D > 25 \text{ mA}$	4.75			
$t_{low \text{ min}}$	Min. duration $V_{D,low}$			30		ms
$t_{Df}$	Response to $V_{D,low}$			1		ms
$I_D$	Current through D				20	mA

### K Connector Coding Strip

For PSL models only.

### G RoHS Compliance

Models with G are RoHS-compliant for all six substances.

### Accessories

A variety of electrical and mechanical accessories are available including:

- Battery sensor [S-KSMH...] for using the regulator as battery charger. Different cell characteristics can be selected; see fig. 17 and the [Temperature Sensors](#) data sheet.

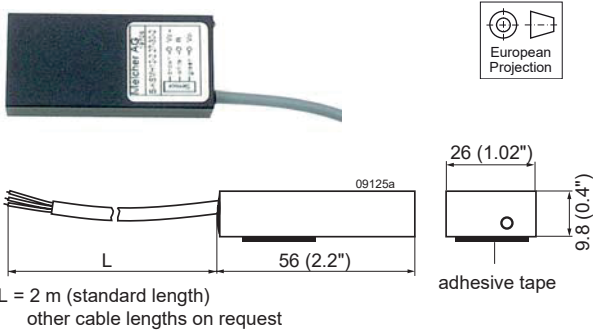

Fig. 17  
Battery temperature sensors

### Accessories suitable for PSC models

- Solder-tags for direct mounting of the regulator to a PCB board (Delivery content: 10 pcs); see fig. 18.
- Different filters and ring core chokes for ripple and interference reduction; see fig. 19
- PCB isolation pads for easy and safe PCB-mounting; see fig. 20
- Input filters FP; see table 13 and fig. 21.

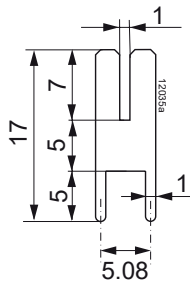

Fig. 18  
Solder tag HZZ01204-G.

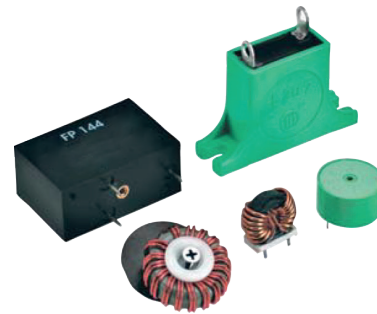

Fig. 19  
Different filters

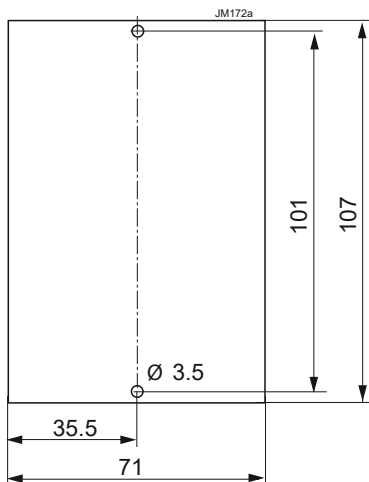

Fig. 20  
Different mating connectors, including code key system

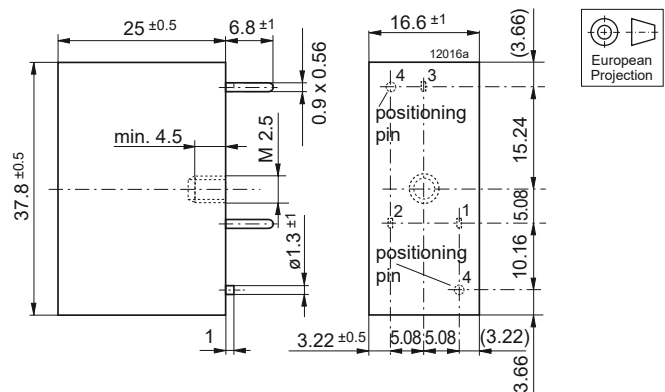

Fig. 21  
Mechanical data of FP filters. Weight approx. 30 g

Table 13: Input filters FP.  $T_A = 25^\circ\text{C}$  unless otherwise specified

Characteristics		Conditions	FP 38 <sup>2</sup>			FP 80			FP 144			Unit
			min	typ	max	min	typ	max	min	typ	max	
$I_{Fn}$	Rated current <sup>1</sup>	$L = 0.75 L_o$	4			4			2			A
$V_{Fn}$	Rated voltage	$T_{C\min} - T_{C\max}$	5		40	5		80	15		144	VDC
$R_F$	Ohmic resistance		18	20	22	18	20	22	90	95	100	mΩ
$L_o$	No load inductance	$I_L = 0, T_{C\min} - T_{C\max}$	30	34	38	30	34	38	88	100	112	μH
$T_A$	Ambient temperature	$I_F = I_{Fn}$	- 40		80	- 40		80	- 40		95	°C
$T_C$	Case temperature		- 40		92	- 40		92	- 40		98	
$T_S$	Storage temperature	Not operational	- 40		100	- 40		100	- 55		100	

<sup>1</sup> For currents  $I_F > 4$  A the following derating takes place:  $T_{A\max} = 100 - 1.3 \cdot I_F^2$  [°C],  $T_{C\max} = 100 - 0.49 \cdot I_F^2$  [°C].

<sup>2</sup> FP 38 is obsolete.

### Accessories suitable for PSL models:

- Various mating connectors H11, including screw, solder, fast-on, or press-fit terminals; see the data sheet [Cassette Style Mating Connectors](#).
- Code key system for connector coding. Coding wedges HZZ00202-G (5 pieces); see fig. 22.
- Various front panels for 19" racks with 3U height, Schroff or Intermas; see fig. 23.

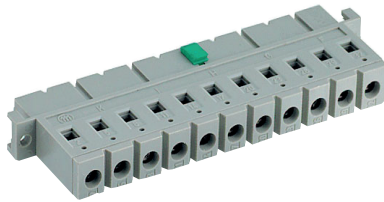

Fig. 22  
Different mating connectors, including code key system



Fig. 23  
Different front panels

For additional accessory product information, see the accessory data sheets listed with each product series at our web site.

**NUCLEAR AND MEDICAL APPLICATIONS** - These products are not designed or intended for use as critical components in life support systems, equipment used in hazardous environments, or nuclear control systems.

**TECHNICAL REVISIONS** - The appearance of products, including safety agency certifications pictured on labels, may change depending on the date manufactured. Specifications are subject to change without notice.

Компания «Океан Электроники» предлагает заключение долгосрочных отношений при поставках импортных электронных компонентов на взаимовыгодных условиях!

Наши преимущества:

- Поставка оригинальных импортных электронных компонентов напрямую с производств Америки, Европы и Азии, а так же с крупнейших складов мира;
- Широкая линейка поставок активных и пассивных импортных электронных компонентов (более 30 млн. наименований);
- Поставка сложных, дефицитных, либо снятых с производства позиций;
- Оперативные сроки поставки под заказ (от 5 рабочих дней);
- Экспресс доставка в любую точку России;
- Помощь Конструкторского Отдела и консультации квалифицированных инженеров;
- Техническая поддержка проекта, помощь в подборе аналогов, поставка прототипов;
- Поставка электронных компонентов под контролем ВП;
- Система менеджмента качества сертифицирована по Международному стандарту ISO 9001;
- При необходимости вся продукция военного и аэрокосмического назначения проходит испытания и сертификацию в лаборатории (по согласованию с заказчиком);
- Поставка специализированных компонентов военного и аэрокосмического уровня качества (Xilinx, Altera, Analog Devices, Intersil, Interpoint, Microsemi, Actel, Aeroflex, Peregrine, VPT, Syfer, Eurofarad, Texas Instruments, MS Kennedy, Miteq, Cobham, E2V, MA-COM, Hittite, Mini-Circuits, General Dynamics и др.);

Компания «Океан Электроники» является официальным дистрибьютором и эксклюзивным представителем в России одного из крупнейших производителей разъемов военного и аэрокосмического назначения «JONHON», а так же официальным дистрибьютором и эксклюзивным представителем в России производителя высокотехнологичных и надежных решений для передачи СВЧ сигналов «FORSTAR».



## JONHON

«JONHON» (основан в 1970 г.)

Разъемы специального, военного и аэрокосмического назначения:

(Применяются в военной, авиационной, аэрокосмической, морской, железнодорожной, горно- и нефтедобывающей отраслях промышленности)

«FORSTAR» (основан в 1998 г.)

ВЧ соединители, коаксиальные кабели, кабельные сборки и микроволновые компоненты:

(Применяются в телекоммуникациях гражданского и специального назначения, в средствах связи, РЛС, а так же военной, авиационной и аэрокосмической отраслях промышленности).



Телефон: 8 (812) 309-75-97 (многоканальный)

Факс: 8 (812) 320-03-32

Электронная почта: [ocean@oceanchips.ru](mailto:ocean@oceanchips.ru)

Web: <http://oceanchips.ru/>

Адрес: 198099, г. Санкт-Петербург, ул. Калинина, д. 2, корп. 4, лит. А