



Description

The RCM Series converters are reliable power supplies for railway and transportation systems. There are 2 input voltage ranges covering all common railway batteries. The output delivers 150 or 300 W at 12 or 24 V. The converters are designed for chassis mounting and exhibit a closed housing.

Many options are available, such as an output ORing FET for redundant operation, output voltage adjustment, interruption time of 10 ms (class ST2), shutdown input, and an output voltage monitor controlling a relay (change-over contact).

Features

- RoHS lead-free-solder product
- 2 input voltage ranges, covering all railway batteries
- 2 output voltages, 12 and 24 V
- Closed housing for chassis mounting
- Extremely high efficiency and high power density
- Low inrush current
- 3 connectors: Input, output, auxiliary
- Overtemperature, overvoltage, overcurrent, and overload protection
- Many options available
- Compliant to EN 50155, EN 50121-3-2
- Fire and smoke: compliant to EN 45545 and NFPA 130

Safety-approved to the latest edition of IEC/EN 60950-1 and UL/CSA 60950-1 in process



¹ pending



Table of Contents

Table of Contents	Page	Page	
Description	1	Electromagnetic Compatibility (EMC)	9
Model Selection	2	Immunity to Environmental Conditions	11
Functional Description	3	Mechanical Data	12
Electrical Input Data	4	Safety and Installation Instructions	13
Electrical Output Data	6	Accessories	14
Description of Options	8		

Copyright © 2017, Bel Power Solutions Inc. All rights reserved.



Model Selection

Table 1: Model Selection

$V_{i \min}^1$ [V]	Input voltage			$V_{i \max}^1$ [V]	Output		Power $P_{o \text{ nom}}$ [W]	Efficiency		Model	Options
	$V_{i \text{ cont}}$ [V]				$V_{o \text{ nom}}$ [V]	$I_{o \text{ nom}}$ [A]		η_{\min}^2 [%]	η_{typ} [%]		
14.4	16.8	(24)	45	50.4	12 24	12.5 6.25	150 150	88 89		24RCM150-12 24RCM150-24	D, M, Q, F
43.2	50.4	(110)	137.5	154	12 24	12.5 6.25	150 150	91 91	92.5 93	110RCM150-12 110RCM150-24	D, M, Q, F
14.4	16.8	(24)	45	50.4	12 24	25 12.5	300 300	89 90		24RCM300-12 24RCM30024	D, M, Q, F
43.2	50.4	(110)	137.5	154	12 24	25 12.5	300 300	91 92	93.5	110RCM300-12 110RCM300-24	D, M, Q, F

¹ Short time; see table 2 for details

² Efficiency at $T_A = 25^\circ\text{C}$, $V_{i \text{ nom}}$, $I_{o \text{ nom}}$, $V_{o \text{ nom}}$, only option D fitted

Part Number Description

Operating input voltage $V_{i \text{ cont}}$ (continuously):

16.8 – 45 VDC 24
 50.4 – 137.5 VDC 110

Series RCM

Output power:

150 W 150
 300 W 300

Nominal output voltage:

12 V -12
 24 V -24

Auxiliary functions and options:

Out OK, output voltage adjust, shutdown ¹ D
 Interruption time M
 ORing FET Q
 Fuse F

110 RCM 150 -24 D M Q

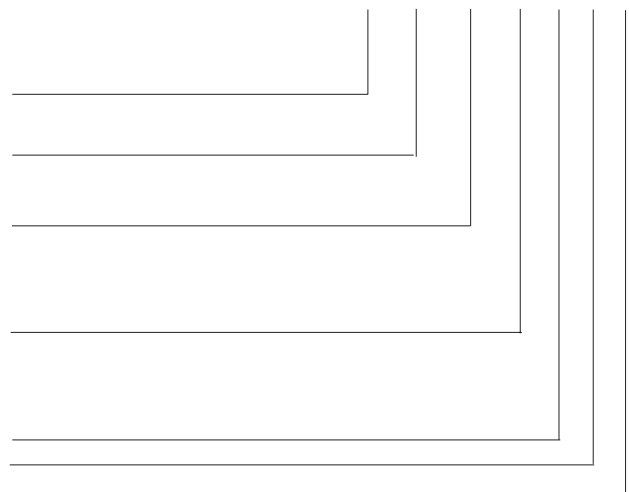

¹ Opt. D requires the signal connector.

Note: The sequence of options must follow the order above.

Note: All models are RoHS-compliant for all six substances.

Example: 110RCM150-24DMQ: DC-DC converter, input voltage range 50.4 to 137.5 V continuously, output providing 24 V / 6.25 A, monitoring relay, output voltage adjust, shutdown input, interruption time 10 ms, integrated ORing FET, operating ambient temperature $T_A = -40$ to 70°C , RoHS-compliant for all six substances.

Available combinations of options:

24/110RCMxxx-xx	No option
24/110RCMxxx-xxD	Basic communication model
24/110RCMxxx-xxDF	Industrial version
24/110RCMxxx-xxDMQ	Railway version
24/110RCMxxx-xxDMQF	All options

Product Marking

Type designation, applicable safety approval and recognition marks, CE mark, pin allocation, and product logo.

Input voltage range and input current, nominal output voltage and current, degree of protection, batch no., serial no., and data code including production site, version (modification status) and date of production.

Functional Description

The converters are designed as active clamp forward converters with a switching frequency of approximately 135 kHz. The built-in high-efficient input filter together with a small input capacitance generates very low inrush current of short duration. An antiparallel suppressor diode acts as reverse polarity protection together with the external circuit breaker or fuse.

The circuitry providing the interruption time (opt. M) is located after the input filter.

The rectification on the secondary side is provided by synchronous rectifiers, in order to keep the losses as low as possible. The output voltage control logic is located on the secondary side and influences the primary logic through magnetic feedback.

An auxiliary converter supplies all circuits with a stable bias voltage.

An output ORing FET is available (option Q) and allows for a redundant power supply system. If there are no external circuit breakers, it is possible to order the converter with incorporated fuse (opt. F). Because this fuse is not accessible, a serial diode provides the reverse polarity protection (only with option F or M).

Opt. D encompasses an additional signal connector and allows for output voltage adjust and a primary shutdown. An output voltage monitor controls a relay with a change-over contact.

The converter is mounted onto a base plate, which acts as heat sink. An additional heatsink for air cooling is available as accessory.

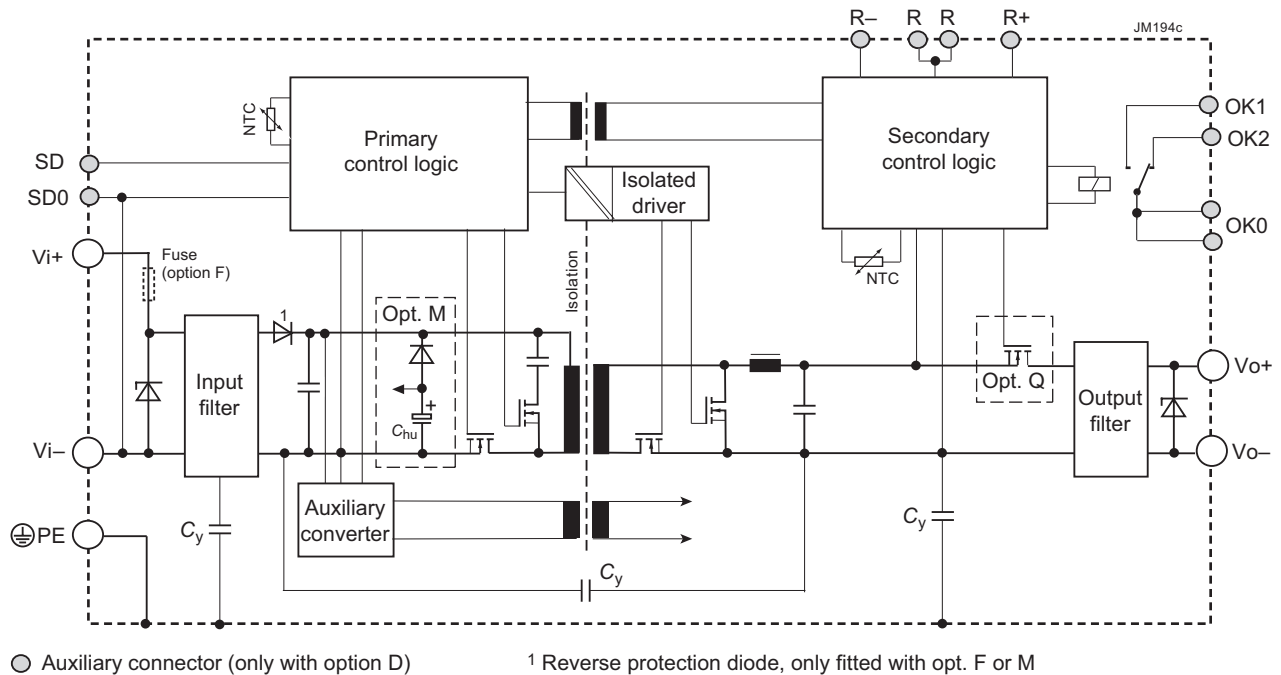

Fig. 1
Block diagram

Electrical Input Data

General Conditions:

- $T_A = 25\text{ °C}$, unless T_C is specified.
- R input not connected

Table 2a: Input data of RCM150

Input			24RCM150			110RCM150			Unit	
Characteristics	Conditions	min	typ	max	min	typ	max			
V_i	Operating input voltage	$I_o = 0 - I_{o\text{ max}}$ $T_{C\text{ min}} - T_{C\text{ max}}$		16.8	(24)	45.0	50.4	(110)	137.5	V
V_{i2s}	for ≤ 2 s	without shutdown		14.4		50.4	43.2		154	
$V_{i\text{ nom}}$	Nominal input voltage	24, 36			72, 96, 110					
$V_{i\text{ abs}}$	Input voltage limits	3 s without damage		0		55	0		165	
I_i	Typical input current	$V_{i\text{ nom}}, I_{o\text{ nom}}$					1.5			A
P_{i0}	No-load input power	$V_{i\text{ min}} - V_{i\text{ max}}, I_o = 0$					4 ²		6	W
P_{iSD}	Idle input power	$V_{i\text{ min}} - V_{i\text{ max}}, V_{SD} = 0$ V					0.7 ²		1.5	
C_i	Input capacitance ¹						10			μF
R_i	Input resistance								100	m Ω
I_{inrp}	Peak inrush current	$V_i = 137.5$ V, $I_{o\text{ nom}}$							20	A
t_{inrd}	Duration of inrush current								10	ms
t_{on}	Start-up time at switch on	$0 \rightarrow V_{i\text{ min}}, I_{o\text{ nom}}$				1000			1000	
	Start-up time after removal of shutdown	$V_{i\text{ min}} \geq 16.8$ V, $I_{o\text{ nom}}$ $V_{SD} = 0 \rightarrow 5$ V				300			300	

Table 2b: Input data of RCM300

Input			24RCM300			110RCM300			Unit	
Characteristics	Conditions	min	typ	max	min	typ	max			
V_i	Operating input voltage	$I_o = 0 - I_{o\text{ max}}$ $T_{C\text{ min}} - T_{C\text{ max}}$		16.8	(24)	45.0	50.4	(110)	137.5	V
V_{i2s}	for ≤ 2 s	without shutdown		14.4		50.4	43.2		154	
$V_{i\text{ nom}}$	Nominal input voltage	24 (36)			(72) (96) 110					
$V_{i\text{ abs}}$	Input voltage limits	3 s without damage		0		55	0		165	
I_i	Typical input current	$V_{i\text{ nom}}, I_{o\text{ nom}}$					3			A
P_{i0}	No-load input power	$V_{i\text{ min}} - V_{i\text{ max}}, I_o = 0$					5			W
P_{iSD}	Idle input power	$V_{i\text{ min}} - V_{i\text{ max}}, V_{SD} = 0$ V							1	
C_i	Input capacitance ¹						12			μF
R_i	Input resistance									m Ω
I_{inrp}	Peak inrush current	$V_i = 137.5$ V, $I_{o\text{ nom}}$								A
t_{inrd}	Duration of inrush current								0	ms
t_{on}	Start-up time at switch on	$0 \rightarrow V_{i\text{ min}}, I_{o\text{ nom}}$				1000			1000	
	Start-up time after removal of shutdown	$V_{i\text{ min}} \geq 16.8$ V, $I_{o\text{ nom}}$ $V_{SD} = 0 \rightarrow 5$ V				300			300	

¹ Not smoothed by the inrush current limiter at start-up (for inrush current calculation)

² Typ. value at $V_{i\text{ max}}$. At lower V_i , the idle and low-load input power is smaller.

Input Transient and Reverse Polarity Protection

A suppressor diode and a symmetrical input filter form an effective protection against input transients, which typically occur in most installations, but especially in battery-driven mobile applications. If the input voltage has the wrong polarity, an antiparallel diode will cause the external input circuit breaker or fuse to trip. If the fuse is incorporated (opt. F), a serial diode prevents reverse current.

Input Under-/Overvoltage Lockout

If the input voltage is out of range, an internally generated inhibit signal disables the converter to avoid any damage.

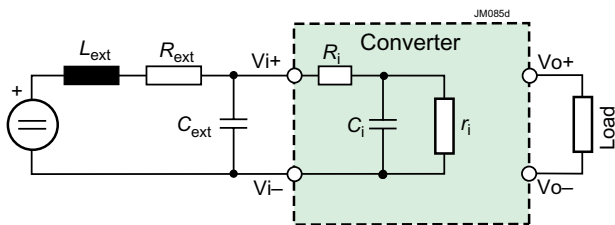

Fig. 2
Input configuration

Inrush Current and Stability with Long Supply Lines

The converter operates with relatively small input capacitance C_i resulting in low inrush current of short duration.

If a converter is connected to the power source through supply lines with reasonable length, no additional measures are necessary to ensure stable operation.

Only in the case of very long supply lines exhibiting a considerable inductance L_{ext} , an additional external capacitor C_{ext} connected across the input pins improves the stability and prevents oscillations.

Actually, an RCM Series converter with its load acts as negative resistor r_i , because the input current I_i rises, when the input voltage V_i is decreased. It tends to oscillate with a resonant frequency determined by the line inductance L_{ext} and the input capacitance $C_i + C_{ext}$, damped by the resistor R_{ext} . The whole system is not linear at all and eludes a simple calculation. One basic condition is given by the formula:

$$C_i + C_{ext} > \frac{L_{ext} \cdot P_{o,max}}{R_{ext} \cdot V_{i,min}^2} \quad \left(r_i = \frac{dV_i}{dI_i} \right)$$

R_{ext} is the series resistor of the voltage source including supply lines. If this condition is not fulfilled, the converter may not

Table 3: Recommended values for the capacitor C_{ext}

$V_{B,nom}$	RC150	RCM300	Rated voltage
24 V	1500 μ F	3000 μ F	40 V
36 V	1000 μ F	2000 μ F	63 V
72 V	220 μ F	440 μ F	125 V
110 V	100 μ F	200 μ F	200 V

reach stable operating conditions. Worst case conditions are at lowest V_i and highest output power P_o .

Recommended values for C_{ext} for different batteries are listed in table 3, which should allow for stable operation up to an input inductance of 2 mH. C_i is specified in table 2.

Efficiency

The efficiency depends on the model and on the input voltage.

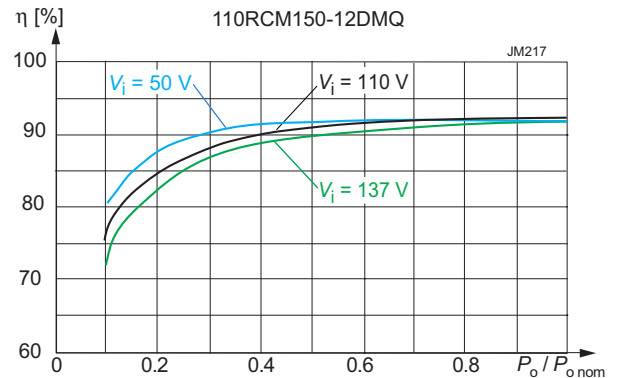

Fig. 3a
Efficiency versus V_i and P_o (110RCM150-12)

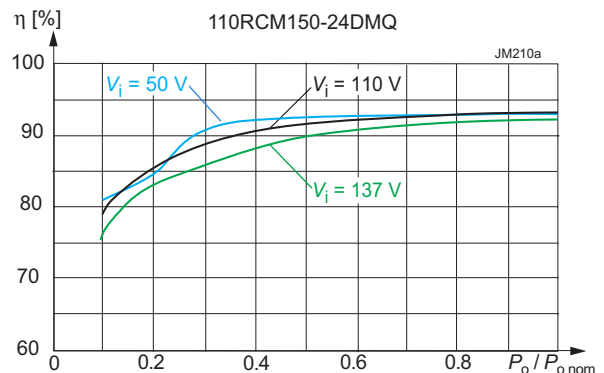

Fig. 3b
Efficiency versus V_i and P_o (110RCM150-24)

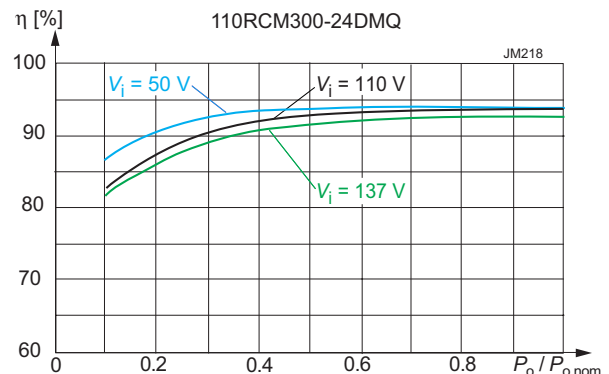

Fig. 3c
Efficiency versus V_i and P_o (110RCM300-24)

Electrical Output Data

General Conditions:

- $T_A = 25^\circ\text{C}$, unless T_C is specified.
- R input not connected

Table 4a: Output data of RCM150

Output			12 V			24 V			Unit
Characteristics		Conditions	min	typ	max	min	typ	max	
V_o	Output voltage ¹	$V_{i\text{ nom}}, 0.5 I_{o\text{ nom}}$	11.88	12	12.12	23.76	24	24.24	V
V_{ow}	Worst case output voltage	$V_{i\text{ min}} - V_{i\text{ max}}$ $T_{C\text{ min}} - T_{C\text{ max}}, 0 - I_{o\text{ nom}}$	11.64		12.36	23.28		24.72	
V_{odroop}	Voltage droop			-20			-40		mV/A
V_{oP}	Overvoltage protection ²		14.3	15	15.8	28.5	30	31.5	V
V_{oL}	Overvoltage shutdown ⁶			14			28		
$I_{o\text{ nom}}$	Nominal output current			12.5			6.25		A
I_{oL}	Output current limit	$T_{C\text{ min}} - T_{C\text{ max}}$	13.0		14.4	6.5		7.2	
v_o	Output noise ³	Switch. frequ.	$V_{i\text{ nom}}, I_{o\text{ nom}}$			80			mV _{pp}
		Total incl. spikes	BW = 20 MHz			120			
v_{od}	Dynamic load regulation	Voltage deviation ⁵	$V_{i\text{ nom}}$ $0.1 \leftrightarrow 0.9 I_{o\text{ nom}}$			1000			
t_d ⁴		Recovery time				5			ms
α_{V_o}	Temp. coefficient of V_o (NTC)	$0 - I_{o\text{ nom}}, T_{C\text{ min}} - T_{C\text{ max}}$	-0.02		0	-0.02		0	%/K

Table 4b: Output data of RCM300

Output			12 V			24 V			Unit
Characteristics		Conditions	min	typ	max	min	typ	max	
V_o	Output voltage ¹	$V_{i\text{ nom}}, 0.5 I_{o\text{ nom}}$	11.88	12	12.12	23.76	24	24.24	V
V_{ow}	Worst case output voltage	$V_{i\text{ min}} - V_{i\text{ max}}$ $T_{C\text{ min}} - T_{C\text{ max}}, 0 - I_{o\text{ nom}}$	11.64		12.36	23.28		24.72	
V_{odroop}	Voltage droop								mV/A
V_{oP}	Overvoltage protection ²		14.3	15	15.8	28.5	30	31.5	V
V_{oL}	Overvoltage shutdown ⁶			14			28		
$I_{o\text{ nom}}$	Nominal output current			25			12.5		A
I_{oL}	Output current limit	$T_{C\text{ min}} - T_{C\text{ max}}$				13.5		15	
v_o	Output noise ³	Switch. frequ.	$V_{i\text{ nom}}, I_{o\text{ nom}}$			80			mV _{pp}
		Total incl. spikes	BW = 20 MHz			120			
v_{od}	Dynamic load regulation	Voltage deviation ⁵	$V_{i\text{ nom}}$ $0.1 \leftrightarrow 0.9 I_{o\text{ nom}}$						
t_d ⁴		Recovery time				5			ms
α_{V_o}	Temp. coefficient of V_o (NTC)	$0 - I_{o\text{ nom}}, T_{C\text{ min}} - T_{C\text{ max}}$	-0.02		0	-0.02		0	%/K

¹ If the output voltage is increased above $V_{o\text{ nom}}$ through R-input control, the output power should be reduced accordingly, so that $P_{o\text{ max}}$ and $T_{C\text{ max}}$ are not exceeded.

² Breakdown voltage of the incorporated suppressor diode at 1 mA. Exceeding this value might damage the suppressor diode.

³ Measured according to IEC/EN 61204 with a probe described in annex A

⁴ Recovery time until V_o returns to $\pm 1\%$ of V_o ; see fig. 4.

⁵ No overshoot at switch on.

⁶ Output overvoltage protection by an electronic circuitry.

Output Voltage Regulation

Line and load regulation of the output is so good that input voltage and output current have virtually no influence to the output voltage.

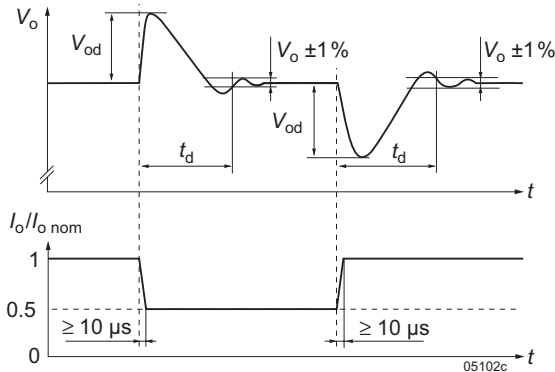

Fig. 4
Typical dynamic load regulation of output voltage

Thermal Considerations

A temperature protection is incorporated in the primary and secondary control logic each.

Output Current Limitation

The output is continuously protected against open-circuit (no load) and short-circuit by an electronic current limitation with rectangular characteristic; see fig. 5.

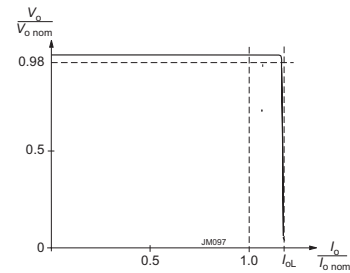

Fig. 5
Rectangular current limitation of single-output models

Parallel and Series Connection

The outputs of max. 5 RCM Series converters may be connected in series without restrictions.

Note: If the sum of the output voltages is greater than 60 V, it cannot be considered being SELV (Safety Extra Low Voltage) according to the safety standards.

Parallel operation is only recommended for redundant systems (option Q). To ensure proper current sharing, the load lines should have equal length and section. The output voltage exhibits a slight droop characteristic, which facilitates current sharing. In addition, the output voltage tends to be lowered with increasing temperature.

Redundant Systems

For redundant systems, we recommend the options Q and D, see *Options*.

LED Indicator

The converters exhibit a green LED "Out OK", signaling that the output voltage is within the specified range.

Description of Options

Option D: Output Monitor, Output Adjust, Shutdown

Option D consists of several auxiliary functions and encompasses an additional auxiliary connector.

Output Voltage Adjust (R)

Note: With open R-input, $V_o = V_{o, nom}$.

The converter allows for adjusting the output voltage in the range of 80 to 105% of $V_{o, nom}$. The adjust is accomplished by an external resistor R_{ext1} or R_{ext2} , connected to the R-input; see fig. 6.

Depending on the value of the required output voltage, the resistor shall be connected:

either: Between the R-pin and R- to adjust the output voltage to a value below $V_{o, nom}$:

$$R_{ext1} \approx 4 \text{ k}\Omega \cdot \frac{V_o}{V_{o, nom} - V_o} - 15.8 \text{ k}\Omega$$

Note: $R_{ext1} = 0 \Omega$ reduces V_o to 80%.

or: Between the R-pin and R+ to adjust the output voltage to a value greater than $V_{o, nom}$:

$$R_{ext2} \approx 4 \text{ k}\Omega \cdot \frac{(V_o - 2.5 \text{ V})}{2.5 \text{ V} \cdot (V_o/V_{o, nom} - 1)} - 682 \text{ k}\Omega$$

Note: $R_{ext2} = 0 \Omega$ increases V_o to 105%.

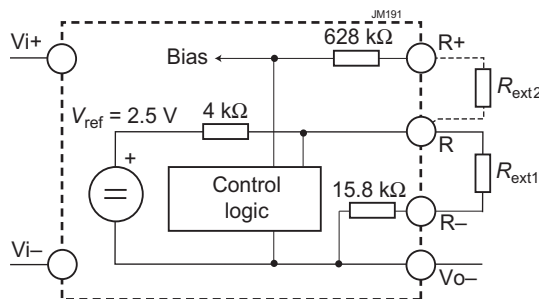

Fig. 6
Output voltage control via R-input

Output Voltage Monitor (D)

The output voltage V_o is monitored. When V_o is in range, a relay with a change-over contact is activated.

Note: The trigger levels are typ. $\pm 5\%$ of $V_{o, nom}$ (with open R-input).

Data of relay contacts: 0.4 A / 150 VDC or 10 A / 250 VAC

Primary Shutdown (SD)

The output of the converter may be enabled or disabled by a logic signal (e.g. CMOS) applied between the shutdown pin SD and SD0 (= Vi-). If the shutdown function is not required, pin SD can be left open-circuit. Voltage on pin SD:

Converter operating: 12 to 154 V or open-circuit
Converter disabled: -2 to +2 V

The output response is shown in fig. 7.

Note: In systems consisting of several converters, this feature may be used to control the activation sequence by logic signals or to enable the power source to start up, before full load is applied.

Interruption Time (M)

The interruption time t_{hu} is specified in the railway standard EN 50155 clause 5.1.1.3: Class S2 is 10 ms. It is measured at $V_{B, nom}$ (nominal battery voltage) for interruption and short-circuit of the input. After such an event, the system is ready for the next event after 10 s. Fig. 7 shows the output voltage V_o , if option M is fitted.

For less critical applications, option M is not required (class S1, no interruption time).

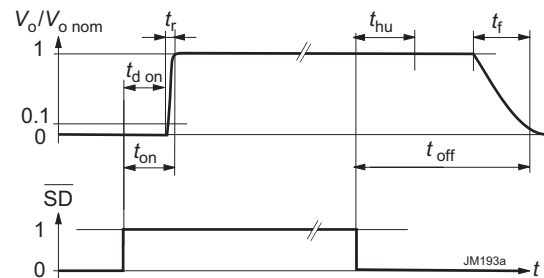

Fig. 7
Typical output response to the SD-signal. If option M is not fitted, $t_{hu} = 0$ ms.

ORing FET (Q) for Redundant Systems

The outputs of 2 parallel connected converters are separated with ORing diodes (built by FETs). If one converter fails, the remaining one must be capable to still deliver the full power to the load. If more power is needed, the system may be extended to more parallel converters (n+1 redundancy).

Current sharing must be ensured by load lines of equal section and length. In addition, a slight droop characteristic of the output voltage and a negative temperature coefficient are helpful as well.

To keep the losses as small as possible, the ORing diode is replaced by a FET. The voltage drop is approx. 22 mV (not dependent of I_o).

Note: In the case of a failing converter, the output voltage is maintained by the redundant converters. However, the failing item should be identified and replaced. We recommend the Out OK function (option D).

Incorporated Fuse (F)

The railway standard EN 50155 bans fuses in the converters. Consequently, the installer must preview an external fuse or circuit breaker. However, when this is not possible, we offer an incorporated fuse. This fuse is not accessible and will not trip, except if the converter is defect.

Note: Converters with option F and option Q are protected against input reverse polarity by a series diode.

Table 5: Recommended for external fuses

Converter	Fuse specification	Ordering number
24RCM150-12, -24	15 A fast acting	BEL 3AB (P) 15-R
24RCM300-12, -24	25 A fast acting	Littlefuse 0314025
110RCM150-12, -24	5 A fast acting	BEL 3AB (P) 5-R
110RCM300-12, -24	8 A fast acting	BEL 3AB (P) 8-R

Electromagnetic Compatibility (EMC)

Electromagnetic Immunity

Table 6: Electromagnetic immunity (type tests)

Phenomenon	Standard	Level	Coupling mode ¹	Value applied	Waveform	Source imped.	Test procedure	In oper.	Perf. crit. ²
Electrostatic discharge (to case)	IEC/EN 61000-4-2	4 ³	contact discharge	6000 V _p	1/50 ns	330 Ω	10 positive and 10 negative discharges	yes	A
			air discharge	8000 V _p					
Electromagnetic field	IEC/EN 61000-4-3	x ⁴	antenna	20 V/m	AM 80% /1 kHz	n.a.	80 – 800 MHz	yes	A
				10 V/m					
				5 V/m					
				3 V/m					
Electrical fast transients/burst	IEC/EN 61000-4-4	3 ⁶	capacitive, o/c	±2000 V _p	bursts of 5/50 ns 2.5/5 kHz over 15 ms; burst period: 300 ms	50 Ω	60 s positive 60 s negative transients per coupling mode	yes	A
		3	i/c, +i/-i direct						
Surges	IEC/EN 61000-4-5	3 ⁹	i/c	±2000 V _p	1.2/50 μs	42 Ω 0.5 μF	5 pos. and 5 neg. surges per coupling mode	yes	A
			+i/-i	±1000 V _p					
Conducted disturbances	IEC/EN 61000-4-6	3 ¹⁰	i, o, signal wires	10 VAC (140 dBμV)	AM 80% 1 kHz	150 Ω	0.15 – 80 MHz	yes	A

¹ i = input, o = output, c = case

² A = normal operation, no deviation from specs.; B = normal operation, temporary loss of function or deviation from specs possible

³ Exceeds EN 50121-3-2:2015 table 6.3

⁴ Corresponds to EN 50121-3-2:2015 table 6.1

⁵ Corresponds to EN 50121-3-2:2015 table 6.2 (compliance with digital mobile phones).

⁶ Corresponds to EN 50121-3-2:2015 table 5.2

⁹ Covers or exceeds EN 50121-3-2:2015 table 4.3

¹⁰ Corresponds to EN 50121-3-2:2015 table 5.1 (radio frequency common mode).

Electromagnetic Emissions

The conducted emissions (fig. 9) have been tested according to EN 55011 (similar to EN 55022, much better values than requested by EN 50121-3-2:2015, table 1.1). The limits in fig. 9 apply to quasipeak values, which are always lower than peak values.

Radiated emissions have been tested according to EN 55011 (similar to EN 55022), class A, as requested in EN 50121-3-2:2015, table 3.1. The test is executed with horizontal and vertical polarization. The worse result is shown in fig. 9.

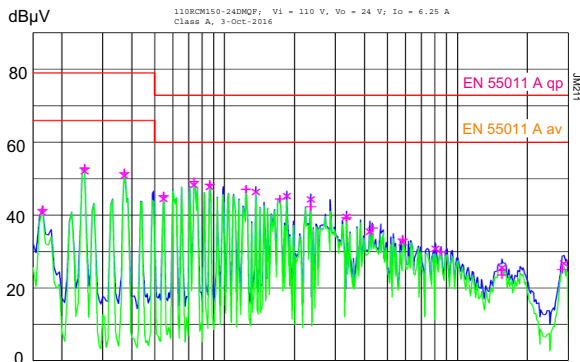

Fig. 8
110RCM150-24: Typ. disturbance voltage at the input ($V_i = 110\text{ V}$, $I_{i\text{ nom}}$, resistive load, quasi peak and average)

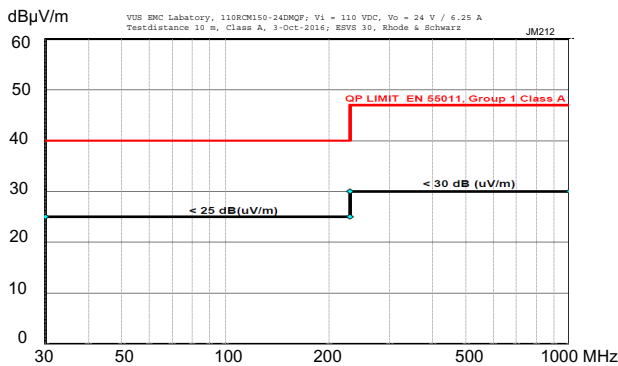

Fig. 9
110RCM150-24: Typ. radiated disturbances in 10 m distance ($V_i = 110\text{ V}$, $I_{i\text{ nom}}$, resistive load, quasi peak).

Immunity to Environmental Conditions

Table 7: Mechanical and climatic stress. Air pressure 800 – 1200 hPa

Test method		Standard	Test conditions		Status
Db	Damp heat test, cyclic	EN 50155:2007, clause 12.2.5 IEC/EN 60068-2-30	Temperature: Cycles (respiration effect): Duration:	55 °C and 25 °C 2 2× 24 h	Converter not operating
Bd	Dry heat test steady state	EN 50155:2007, clause 12.2.4 IEC/EN 60068-2-2	Temperature: Duration:	70 °C 6 h	Converter operating
Ad	Cooling test steady state	EN 50155:2007, clause 12.2.3 IEC/EN 60068-2-1	Temperature, duration Performance test	−40 °C, 2 h +25 °C	Conv. not operating
--	Low temperature storage test	EN 50155:2007, clause 12.2.14 IEC/EN 60068-2-1	Temperature, duration then start-up	−40 °C, 16 h	Conv. not operating
Ka ¹	Salt mist test sodium chloride (NaCl) solution	EN 50155:2007, clause 12.2.10 IEC/EN 60068-2-11 class ST2	Temperature: Duration:	35 ±2 °C 16 h	Converter not operating
--	Shock	EN 50155:2007 clause 12.2.11 EN 61373 sect. 10, class B, body mounted ¹	Acceleration amplitude: Bump duration: Number of bumps:	5.1 g _n 30 ms 18 (3 in each direction)	Converter operating
--	Simulated long life testing at increased random vibration levels	EN 50155:2007 clause 12.2.11 EN 61373 sect. 8 and 9, class B, body mounted ²	Acceleration spectral density: Frequency band: Acceleration magnitude: Test duration:	0.02 g _n ² /Hz 5 – 150 Hz 0.8 g _{n,rms} 15 h (5 h in each axis)	Converter operating

¹ This test is not mandatory in EN 50155. It was not yet executed.

² Body mounted = chassis of a railway coach

Temperatures

Table 8: Temperature specifications, valid for an air pressure of 800 – 1200 hPa (800 – 1200 mbar)

Temperature		Conditions	EN 50155 Class TX			Unit
Characteristics			min	max	10 min.	
T _A	Ambient temperature	Converter operating ¹	−40	70	85	°C
T _C	Case temperature ²		−40	84		
T _S	Storage temperature	Not operational	−55	85		

¹ Over temperature shutdown

² Measured at the measurement point T_C; see *Mechanical Data*.

Reliability

Table 9: MTBF and device hours

Ratings at specified case temperature between failures ¹	Model	MTBF	Demonstrated hours
Accord. to IEC 62380	110RCM+150-24		

¹ Statistical values, based upon an average of 4300 working hours per year and in general field use over 5 years; upgrades and customer-induced errors are excluded.

Mechanical Data

Dimensions in mm.

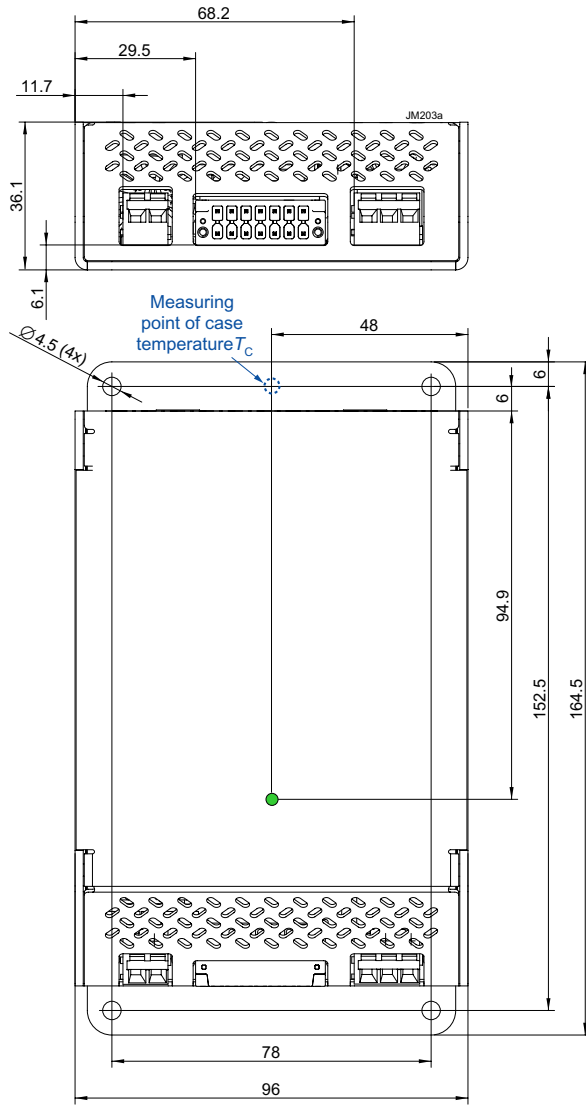

Fig. 10
 Case RCM01, weight approx. 520 g,
 Aluminum, EP-powder coated

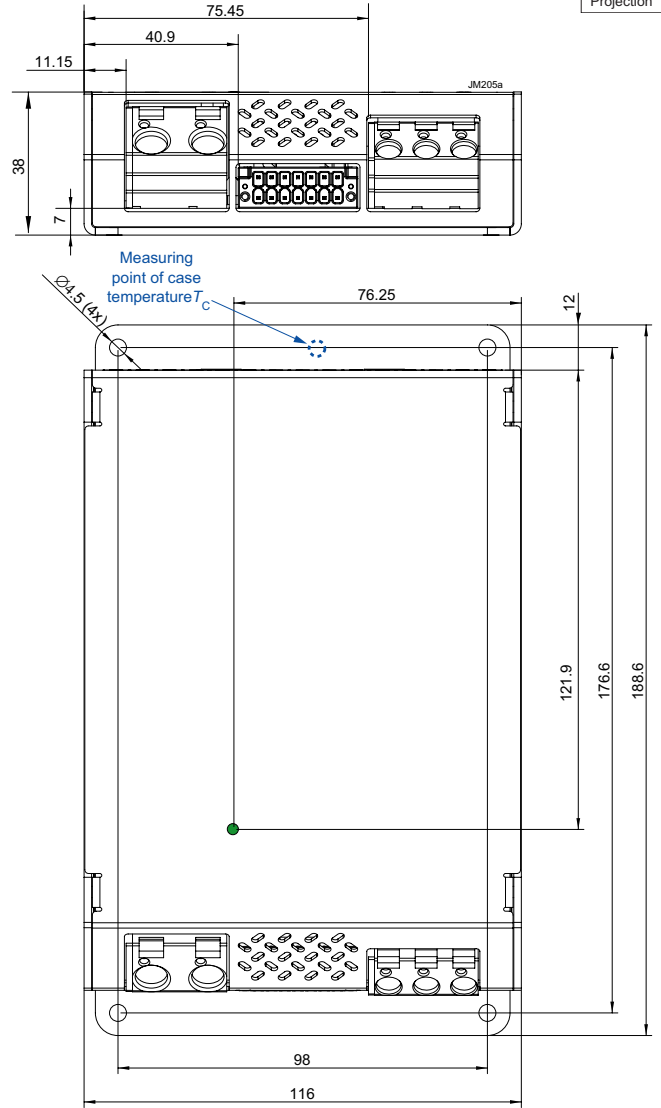

Fig. 11
 Case RCM02, weight approx. 820 g,
 Aluminum, EP-powder coated

Safety and Installation Instruction

Connectors and Pin Allocation of RCM150

- Input connector, 3 pins: Wago 236-403: Vi+, Vi-, PE; recommended wire section: 1.5 – 2.5 mm², 16 – 12 AWG
- Output connector, 2 pins: Wago 236-402: Vo+, Vo-; recommended wire section: 1.5 – 2.5 mm², 16 – 12 AWG
- Auxiliary connector: Phoenix Contact 1713883; recommended wire section: 0.2 – 1.5 mm², 24 – 16 AWG; pin allocation see fig. 12.

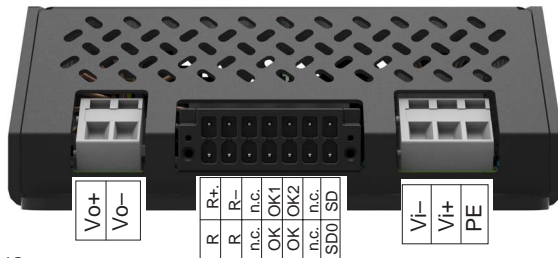

Fig. 12
Pin allocation of RCM150

Connectors and Pin Allocation of RCM300

- Input connector, 3 pins: Wago 745-353: Vi-, Vi+, PE recommended wire section: 2.5 – 6 mm², 14 – 10 AWG
- Output connector, 2 pins: Wago 745-602/006, Vo-, Vo+ recommended wire section: 2.5 – 16 mm², 14 – 6 AWG
- Auxiliary connector: Phoenix Contact 1713883; recommended wire section: 0.2 – 1.5 mm², 24 – 16 AWG; pin allocation see fig. 13.

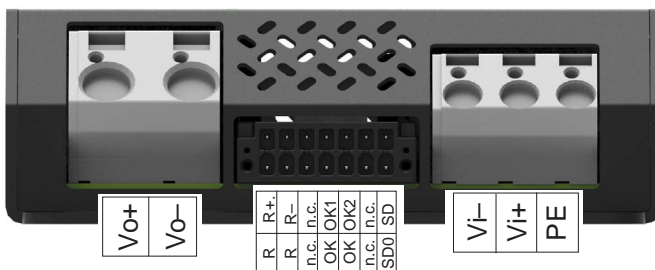

Fig. 13
Pin allocation of RCM300

Table 10: Isolation

Characteristic		Input to		Output to case	OK contacts to			Unit
		output ¹	case+output		input	case	outputs	
Electric strength test	Factory test >1 s	4.2	2.86	1.0	2.86	2.86	2.86	kVDC
	AC test voltage equivalent to actual factory test	3.0	2.0	0.7	2.0	2.0	2.0	kVAC
Insulation resistance		>300 ²	>300 ²	>100	>300	>300	>300	MΩ
Creepage distances		5.0	3.5	1.5	3.5	3.5	3.5	mm

¹ Pretest of subassemblies in accordance with IEC/EN 60950

² Tested at 500 VDC

Installation Instruction

These converters are components, intended exclusively for inclusion by an industrial assembly process or by a professionally competent person. Installation must strictly follow the national safety regulations in respect of the enclosure, mounting, creepage distances, clearances, markings and segregation requirements of the end-use application.

Connection to the system shall only be effected with cables with suitable section (primary and secondary connector in cage clamp technique).

The auxiliary connector shall be connected via the suitable female connector; see *Accessories*.

Other installation methods may not meet the safety requirements. Check that PE is safely connected to protective earth.

No fuse is incorporated in the converter (except for option F). An external circuit breaker or a fuse in the wiring to one or both input pins.

Do not open the converters, or the warranty will be invalidated. Make sure that there is sufficient airflow available for convection cooling and that the temperature of the bottom plate is within the specified range. This should be verified by measuring the case temperature at the specified measuring point, when the converter is operated in the end-use application. $T_{C\ max}$ should not be exceeded. Ensure that a failure of the converter does not result in a hazardous condition.

Standards and Approvals

The RCM Series converters are approved according to the safety standards IEC/EN 60950-1 and UL/CSA 60950-1 2nd Ed.

They have been evaluated for:

- Class I equipment
- Building in
- Double or reinforced insulation based on 250 VAC or 240 VDC between input and output, and between input and the relay contacts (OK0, OK1, OK2).
- Pollution degree 2 environment

The converters are subject to manufacturing surveillance in accordance with the above mentioned UL standards and with ISO 9001:2008.

Cleaning Liquids and Protection Degree

The converters are not hermetically sealed. In order to avoid possible damage, any penetration of liquids shall be avoided.

The converters correspond to protection degree IP 20.

Railway Applications

The RCM Series converters have been designed observing the railway standards EN 50155:2007 and EN 50121:2015.

All boards are coated with a protective lacquer. The converters comply with the fire & smoke standard EN 45545, HL1 to HL3.

Voltage Withstand Test

The electric strength test is performed in the factory as routine test in accordance with EN 50514 and IEC/EN 60950 and should not be repeated in the field. The Company will not honor warranty claims resulting from incorrectly executed electric strength tests.

Accessories

Female Connector

A suitable female connector is available.

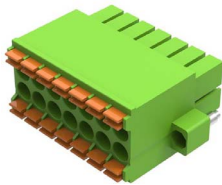

Fig. 14
Female connector 14 pins, HZZ00145-G

Additional Heatsink

A suitable heat sink for air cooling is available, if cooling by wall or a chassis mounting is not possible; see fig. 15.

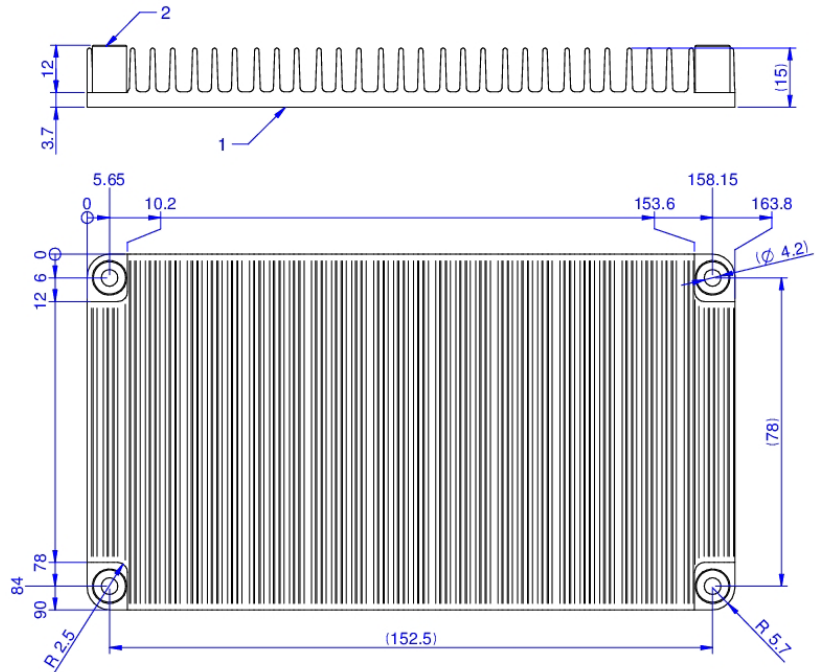

Fig. 15
Additional heatsink for RCM 150

NUCLEAR AND MEDICAL APPLICATIONS - These products are not designed or intended for use as critical components in life support systems, equipment used in hazardous environments, or nuclear control systems.

TECHNICAL REVISIONS - The appearance of products, including safety agency certifications pictured on labels, may change depending on the date manufactured. Specifications are subject to change without notice.

Copyright © 2017, Bel Power Solutions Inc. All rights reserved.

www.belpowersolutions.com

Mouser Electronics

Authorized Distributor

Click to View Pricing, Inventory, Delivery & Lifecycle Information:

[Bel Power Solutions:](#)

[HZZ00145-G](#)

Компания «Океан Электроники» предлагает заключение долгосрочных отношений при поставках импортных электронных компонентов на взаимовыгодных условиях!

Наши преимущества:

- Поставка оригинальных импортных электронных компонентов напрямую с производств Америки, Европы и Азии, а так же с крупнейших складов мира;
- Широкая линейка поставок активных и пассивных импортных электронных компонентов (более 30 млн. наименований);
- Поставка сложных, дефицитных, либо снятых с производства позиций;
- Оперативные сроки поставки под заказ (от 5 рабочих дней);
- Экспресс доставка в любую точку России;
- Помощь Конструкторского Отдела и консультации квалифицированных инженеров;
- Техническая поддержка проекта, помощь в подборе аналогов, поставка прототипов;
- Поставка электронных компонентов под контролем ВП;
- Система менеджмента качества сертифицирована по Международному стандарту ISO 9001;
- При необходимости вся продукция военного и аэрокосмического назначения проходит испытания и сертификацию в лаборатории (по согласованию с заказчиком);
- Поставка специализированных компонентов военного и аэрокосмического уровня качества (Xilinx, Altera, Analog Devices, Intersil, Interpoint, Microsemi, Actel, Aeroflex, Peregrine, VPT, Syfer, Eurofarad, Texas Instruments, MS Kennedy, Miteq, Cobham, E2V, MA-COM, Hittite, Mini-Circuits, General Dynamics и др.);

Компания «Океан Электроники» является официальным дистрибьютором и эксклюзивным представителем в России одного из крупнейших производителей разъемов военного и аэрокосмического назначения «**JONHON**», а так же официальным дистрибьютором и эксклюзивным представителем в России производителя высокотехнологичных и надежных решений для передачи СВЧ сигналов «**FORSTAR**».



JONHON

«**JONHON**» (основан в 1970 г.)

Разъемы специального, военного и аэрокосмического назначения:

(Применяются в военной, авиационной, аэрокосмической, морской, железнодорожной, горно- и нефтедобывающей отраслях промышленности)

«**FORSTAR**» (основан в 1998 г.)

ВЧ соединители, коаксиальные кабели,
кабельные сборки и микроволновые компоненты:

(Применяются в телекоммуникациях гражданского и специального назначения, в средствах связи, РЛС, а так же военной, авиационной и аэрокосмической отраслях промышленности).



Телефон: 8 (812) 309-75-97 (многоканальный)

Факс: 8 (812) 320-03-32

Электронная почта: ocean@oceanchips.ru

Web: <http://oceanchips.ru/>

Адрес: 198099, г. Санкт-Петербург, ул. Калинина, д. 2, корп. 4, лит. А