

3.3 mm Pitch Small Size Connectors for Internal Power Source

DF33C Series

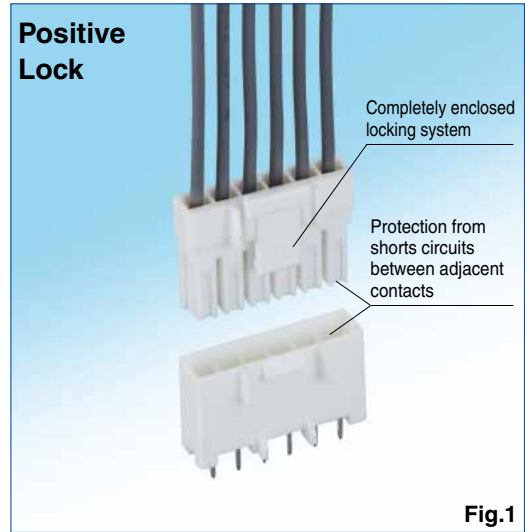
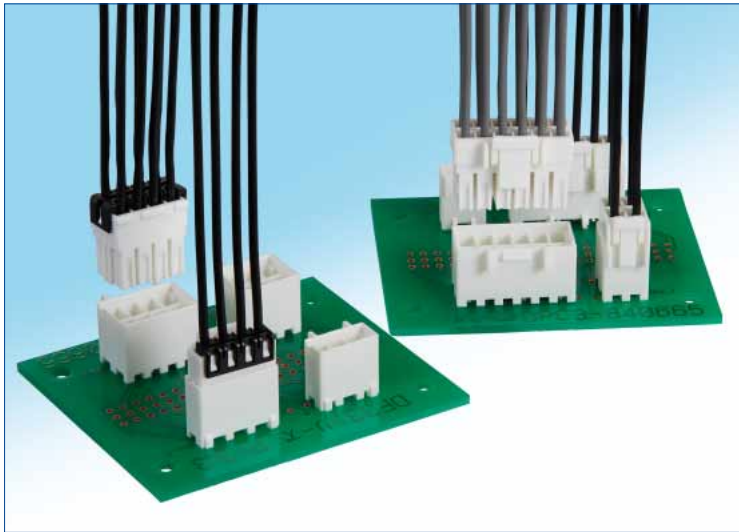

■ Features

1. 5 Amps capacity

When used with 20 AWG wire, this connector has a maximum capacity of 5 Amps.

(For rated current with other types of wires, please refer to the table on the next page)

2. Secure lock mechanism

Outer locking mechanism prevents accidental unmating due to external shocks or drops. (Fig.1)

3. Incorrect mating prevention

Two different housings, a standard and R type, are available to ensure mis-mating does not occur when using multiple DF33C connectors on the same design. (Fig.2)

4. Accurate board placement

Guide posts are used to help with board placement and prevent incorrect mating to the PCB.

5. Supports resin sealing

Accepts resin sealing up to 6.5 mm without affecting the performance.

6. Short circuit prevention

The housing protects each contact by enclosing them in a “box” which also makes each contact independent of each other. This design prevents short circuits between adjacent contacts.

7. Excellent contact retention

A retainer is available to increase contact/cable retention and to assure complete contact insertion. The retainer should also be used when any mechanical stress could be applied to the cable.

8. Prevents solder cracking

To avoid solder crack, a glass-filled resin is used in the header housing to decrease thermal shrinkage.

9. Easy mating operation

A clear tactile click is delivered upon the completion of the mating process. This simplifies mating and increases work efficiency, especially when operating in a noisy environment.

10. Glow Wire compliance (Compliant with IEC 60695-2-11)

Keying for multiple use

● Standard type (Resin: White)

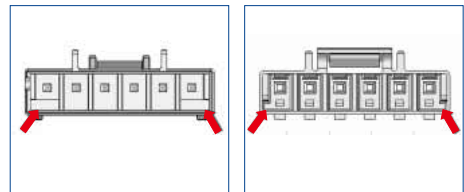

● R type (Resin: Black)

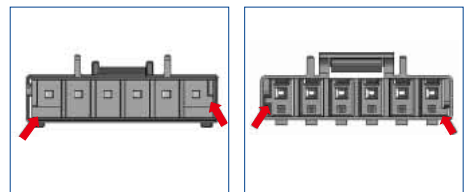

* The image on the left show header (the board dip side), the image on the right show the socket (cabel side).

* This guide key position is indicated in position facing the mating surface of the header.

Fig.2

Product Specifications

Ratings	Rated Current (Note 1)	No. of rows	No. of Contacts	20 AWG	22 AWG	Operating Temperature Range	-35 – 85°C (Note 2)
	Rated Voltage	1	2 to 6 contacts	5A	5A	Operating Humidity Range	40 – 80% (Note 3)
		2	4 to 12 contacts	5A	4A	Storage Temperature Range	-10 – 60°C (Note 4)
	AC/DC 500V					Storage Humidity Range	40 – 70% (Note 4)

Items	Specifications	Conditions
1. Contact Resistance	No more than 10 mΩ (initially)	Measured at 20 mV or below and 1 mA
2. Insulation Resistance	No less than 1,000 MΩ	Measured at DC 500 V
3. Withstanding Voltage	No flashover or breakdown	Apply AC 1500 V for one minute
4. Contact Insertion and Extraction Forces	0.5N Min, 4.5N Max	Measured with a □ 0.5 ±0.002 steel pin
5. Durability	Contact Resistance: no more than 20 mΩ	30 mating cycles
6. Vibration Resistance	No electrical discontinuity of 1μs or greater	Frequency 10-55 Hz, half amplitude 0.75 mm, 3 directions, 10 times each
7. Shock Resistance	No electrical discontinuity of 1μs or greater	Acceleration: 490 m/s ² , 11 ms, Semi-sinusoidal 3 direction 3 times each.
8. Moisture-resistance	Contact Resistance: no more than 20 mΩ Insulation Resistance: no less than 500 MΩ	Left at temperature 40 ±2°C, humidity 90 to 95%, 96 hours
9. Temperature Cycles	Contact Resistance: no more than 20 mΩ Insulation Resistance: no less than 1000 MΩ	-55°C : 30 minutes → 85°C : 30 minutes 5 cycles
10. Soldering Heat Resistance	The resin parts should withstand the temperature and resist melting.	Flow: 260°C, 10 sec. Hand solder: Soldering iron temperature, 300°C, 3 sec.

Note 1 : This is the maximum current rating while all pins are powered or used as all power lines.

If you split the current over multiple lines, please factor in your own safety margin. Please contact Hirose Electric for inquiries on the assignment of pins and on the currents that can be delivered.

Note 2 : Includes temperature rise caused by current flow.

Note 3 : The connector should be completely dry. (no condensation present)

Note 4 : The term “storage” refers to the long-term storage condition of unused products before PCB mounting.

The operating temperature and humidity ranges are applied while in a non-energized state, while in transport or after PCB mounting.

Materials

Product	Component	Materials	Finish	UL rating
Crimp socket	Insulator	PBT	White (Note 1)	UL94V-0
Crimp contact	Contact	Copper alloy	Tin plating	————
Pin header	Insulator	PBT	White (Note 1)	UL94V-0
	Contact	Brass	Tin plating	————
Retainer	Insulator	PBT	Black	UL94V-0

Note 1 : Resin color of different guide key type (DF33CR) is black.

Product Number Structure

●Connector

DF33C R – 2 S – 3.3 C

① ② ③ ④ ⑤ ⑥

●Contact

DF33A – 2022 SCF

⑦ ⑧

① Series Name: DF33C	④ Connector type S: Single row socket DS: Double row socket P: Single row pin header DP: Double row pin header RS: Single row retainer RDS: Double row retainer	⑥ Termination/terminal shape C: Crimp housing DSA: Straight pin header Blank : Retainer
② Guide key shape None: Standard (Resin color: White) R: Different guide key type (Resin color: Black)	⑤ Contact pitch: 3.3 mm	⑦ Applicable wire size 2022: 20 to 22 AWG
③ No. of contacts: 2 to 6 (single row product) : 4 to 12 (double row product)		⑧ Packing type SCF: Socket contact / reel SC: Socket contact / pack

Single row straight pin header

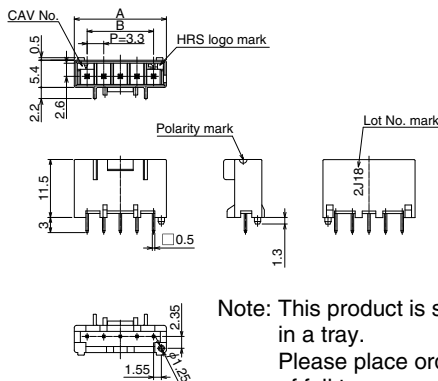

Note: This product is sold and packaged in a tray.
 Please place orders by the number of full trays required.

[Specification No.]
 (24): Tin plating, tray package specification

Standard type (Resin: White)

Part No.	HRS No.	No. of Contacts	A	B	Quantity/Tray
DF33C-2P-3.3DSA(24)	676-1131-2 24	2	8.4	3.3	135
DF33C-3P-3.3DSA(24)	676-1132-5 24	3	11.7	6.6	95
DF33C-4P-3.3DSA(24)	676-1133-8 24	4	15.0	9.9	75
DF33C-5P-3.3DSA(24)	676-1134-0 24	5	18.3	13.2	60
DF33C-6P-3.3DSA(24)	676-1135-3 24	6	21.6	16.5	50

R type (Different guide key type. Resin color: Black)

Available upon request.
 Please contact your local Hirose sales representative.

Recommended PCB layout (Recommended PCB thickness t=1.6 ±0.1)

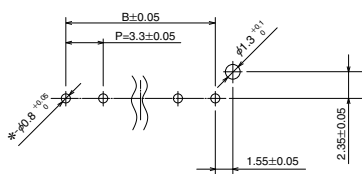

Dimensions in mated condition Application figure

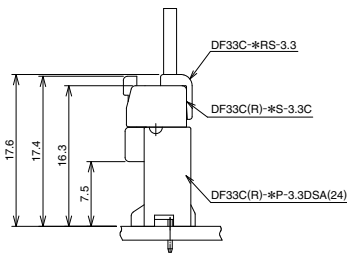

Note: The retainer can be used on both the standard and R type housings.

Double row, straight pin header

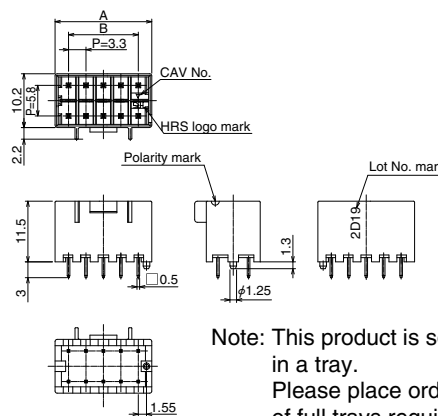

Note: This product is sold and packaged in a tray.
 Please place orders by the number of full trays required.

[Specification No.]
 (24): Tin plating, tray package specification

Standard type (Resin color: White)

Part No.	HRS No.	No. of Contacts	A	B	Quantity/Tray
DF33C-4DP-3.3DSA(24)	676-1113-0 24	4	8.4	3.3	135
DF33C-6DP-3.3DSA(24)	676-1114-3 24	6	11.7	6.6	95
DF33C-8DP-3.3DSA(24)	676-1115-6 24	8	15.0	9.9	75
DF33C-10DP-3.3DSA(24)	676-1116-9 24	10	18.3	13.2	60
DF33C-12DP-3.3DSA(24)	676-1117-1 24	12	21.6	16.5	50

R type (Different guide key type. Resin color: Black)

Available upon request.
 Please contact your local Hirose sales representative.

Recommended PCB layout (Recommended PCB thickness t=1.6 ±0.1)

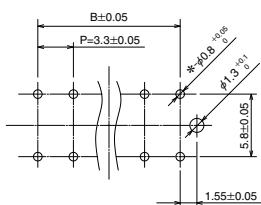

Application figure

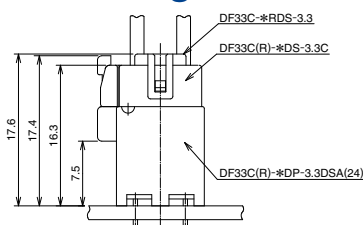

Note: The retainer can be used on both the standard and R type housings.

Single row socket

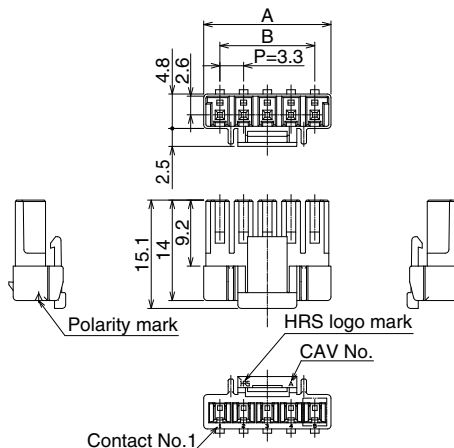

Standard type (Resin color: White)

Part No.	HRS No.	No.of Contacts	A	B
DF33C-2S-3.3C	676-1136-6 00	2	7.8	3.3
DF33C-3S-3.3C	676-1137-9 00	3	11.1	6.6
DF33C-4S-3.3C	676-1138-1 00	4	14.4	9.9
DF33C-5S-3.3C	676-1139-4 00	5	17.7	13.2
DF33C-6S-3.3C	676-1140-3 00	6	21.0	16.5

Note: This product is sold as a 100 pcs/pack.
Please place orders in full pack quantities.
*For the retainers, please refer to page 5.

R type (Different guide key type. Resin color: black)

Available upon request.
Please contact your local Hirose sales representative.

Double row socket

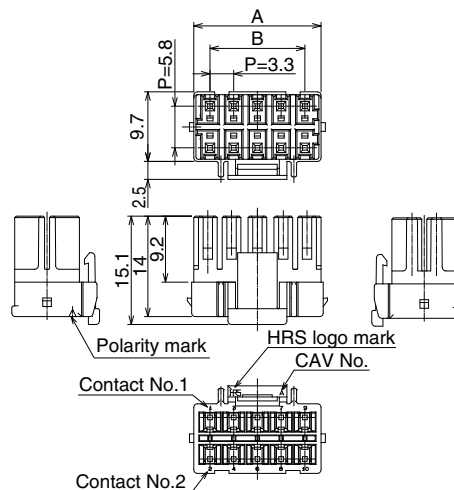
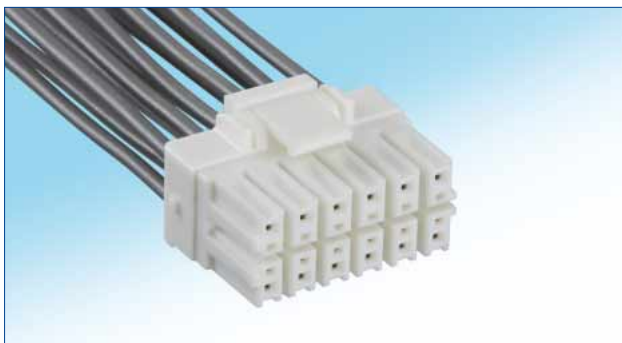

Standard type (Resin color: White)

Part No.	HRS No.	No.of Contacts	A	B
DF33C-4DS-3.3C	676-1119-7 00	4	7.8	3.3
DF33C-6DS-3.3C	676-1120-6 00	6	11.1	6.6
DF33C-8DS-3.3C	676-1121-9 00	8	14.4	9.9
DF33C-10DS-3.3C	676-1122-1 00	10	17.7	13.2
DF33C-12DS-3.3C	676-1123-4 00	12	21.0	16.5

Note: This product is sold as a 100 pcs/pack.
Please place orders in full pack quantities.
*For the retainers, please refer to page 5.

R type (Different guide key type. Resin color: black)

Available upon request.
Please contact your local Hirose sales representative.

Single row retainer

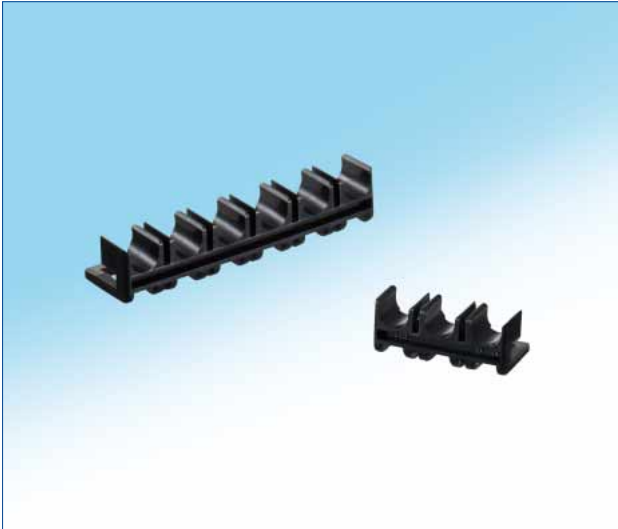

Part No.	HRS No.	No.of Contacts	A	B
DF33C-2RS-3.3	676-1141-6 00	2	6.2	3.3
DF33C-3RS-3.3	676-1142-9 00	3	9.5	6.6
DF33C-4RS-3.3	676-1143-1 00	4	12.8	9.9
DF33C-5RS-3.3	676-1144-4 00	5	16.1	13.2
DF33C-6RS-3.3	676-1145-7 00	6	19.4	16.5

Note: This product is sold as a 100 pcs/pack.
Please place orders in full pack quantities.

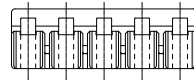
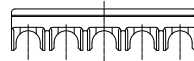
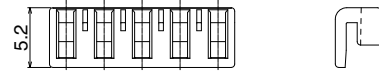
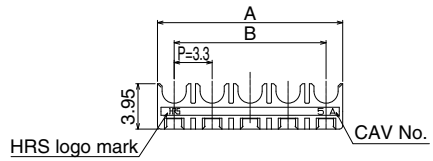

Double row retainer



Part No.	HRS No.	No.of Contacts	A	B
DF33C-4RDS-3.3	676-1125-0 00	4	3.3	8.0
DF33C-6RDS-3.3	676-1126-2 00	6	6.6	11.3
DF33C-8RDS-3.3	676-1127-5 00	8	9.9	14.6
DF33C-10RDS-3.3	676-1128-8 00	10	13.2	17.9
DF33C-12RDS-3.3	676-1129-0 00	12	16.5	21.2

Note: This product is sold as a 100 pcs/pack.
Please place orders in full pack quantities.

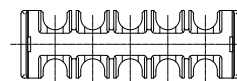
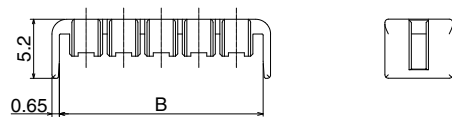
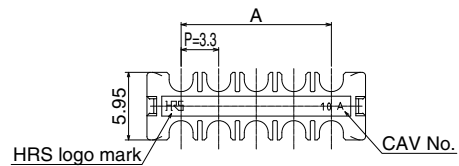

◆ Socket crimp contact

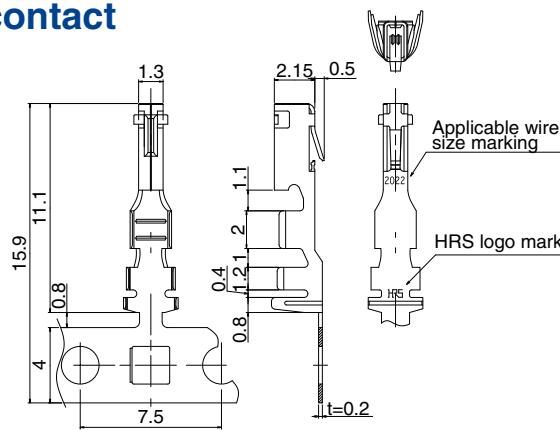

[Specification No.]
(40): 1 reel contains 5,000 pcs

Part No.	HRS No.	Applicable cable				Packaging	Finish
		Style	Jacket diameter	Wire size	Stranded wire conductor		
DF33A-2022SCF(40)	676-1093-5 40	1007	φ1.5 to 1.9mm	22 AWG	17/0.16mm	5,000 /reel	Tin plated
				20 AWG	21/0.18mm		
DF33A-2022SC	676-1094-8	1007	φ1.7mm	22 AWG	17/0.06mm	100 /pack	
			φ1.8mm	20 AWG	21/0.18mm		

Note 1 : Applicable wire with tin plated solid soft conductor.

Note 2 : When using other than the recommended wire, contact your nearest Hirose representative.

Strip length: 2.7 to 3.5mm

◆ Applicable crimp tool

Type	Part No.	HRS No.	Applicable Contact
Applicator	AP105-DF33-2022S	901-4603-0 00	DF33A-2022SCF(40)
Press main body	CM-105C	901-0001-0 00	-
Hand tool	HT304/DF33-2022S	550-0300-1	DF33A-2022SC
Contact unmating tool	DF33-C-PO	902-4551-2 00	DF33A-2022SCF(40) DF33A-2022SC

Note 1 : Hirose does not guarantee products that have been damaged from the use of inapplicable tools

Note 2 : Please do the crimping operations according to the "Crimping quality standard" and "Crimp condition".

◆ Unmating Procedure

- Contact unmating tool: DF33-C-PO
- Applicable contact: DF33A-2022SCF(40), DF33A-2022SC
- Operation method (Example) DF33C-*S-3.3C, DF33A-2022SCF(40)

Housing cross-section figure

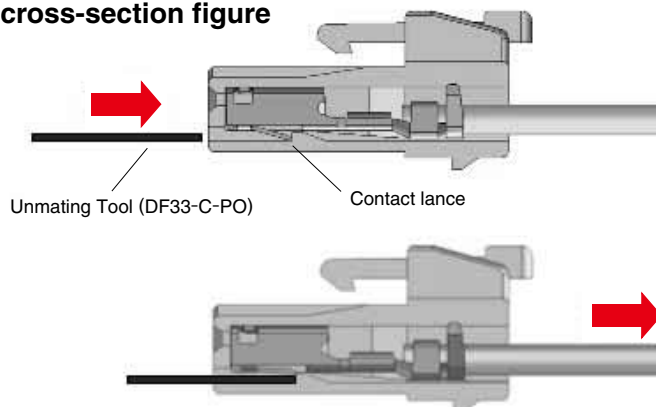

1. Insert the unmating tool and move or disengage the contact lance. (as shown in the example on the left)

2. Make sure that the lance has moved sufficiently enough to allow the terminated wire to be removed easily.

Note: Prior to reusing a crimp contact, make sure that the lance is raised sufficiently to engage with the housing again.



Caution

There are parts on the crimp contact that can cause injuries, please use caution when unmating the contacts.

◆ Operating Precautions

- These connectors can become damaged if excessive force is applied during extraction. If you experience difficulty when unmating this connector, gently push it further into the housing and then operate the lock and release the connector.
- When performing a resin sealing, pay attention to the surface tension of the resin and fill accordingly.
- Wire routing inside the device can cause added tension to be applied to the contacts. Use of a retainer will help remedy the stress placed on the contact.
- Prior to reusing a terminated wire, make sure that the contact's lance is raised to the proper height.
- There may be a slight variance in the color of the molding between production lots, this variance will not affect the performance of the connector.
- Please refer to the documents "Cable assembly Procedure", "Crimp condition" and "Crimp quality standards" for the cable assembly procedures.
- Please refer to the "Nylon Connector Guide" for handling instructions.

◆ Ratings

If the connector is rated at 3 A, and the wire used with the connector only has a 1 A capacity, the connection will be regarded as a 1 A connection. Please make sure that you do not place too much current through this connector. Even though the connector may be rated to take the current applied to it, currents are not always distributed equally due to the differences in wiring path or contact resistance. Due to this precaution, the current may exceed the ratings previously discussed. In these cases, use 1/3 of the noted rating as the maximum. Do not mate/unmate this connector when energized with a live current

(Note 1) "Live" mating and unmating is defined as "to conduct the mating and unmating process while the system is conducting electricity"

◆ Usage Under Harsh Environments

When using these connectors in a harsh environment such as one with repeated high and low temperatures, please contact us for advice.

USA:

HIROSE ELECTRIC (U.S.A.), INC. HEADQUARTERS
2688 Westhills Court, Simi Valley, CA 93065-6235
Phone : +1-805-522-7958
Fax : +1-805-522-3217
<http://www.hirose.com/us/>

USA:

HIROSE ELECTRIC (U.S.A.), INC. DETROIT OFFICE (AUTOMOTIVE)
17197 N. Laurel Park Drive, Suite 253, Livonia, MI 48152
Phone : +1-734-542-9963
Fax : +1-734-542-9964
<http://www.hirose.com/us/>

GERMANY:

HIROSE ELECTRIC EUROPE B.V. NUERNBERG OFFICE
Muggenhofer Str. 136 90429 Nuernberg
Phone : +49-911 32 68 89 63
Fax : +49-911 32 68 89 69
<http://www.hirose.com/eu/>

UNITED KINGDOM:

HIROSE ELECTRIC EUROPE BV (UK BRANCH)
4 Newton Court, Kelvin Drive, Knowlhill, Milton Keynes, MK5 8NH
Phone : +44-1908 202050
Fax : +44-1908 202058
<http://www.hirose.com/eu/>

CHINA:

HIROSE ELECTRIC TECHNOLOGIES (SHENZHEN) CO., LTD.
Room 09-13, 19/F, Office Tower Shun Hing Square, Di Wang Commercial Centre, 5002 Shen Nan Dong Road, Shenzhen City, Guangdong Province, 518008
Phone : +86-755-8207-0851
Fax : +86-755-8207-0873
<http://www.hirose.com/cn/>

KOREA:

HIROSE KOREA CO., LTD.
250, Huimanggongwon-ro, Siheung-si, Gyeonggi-do, Korea, 429-849
Phone : +82-31-496-7000,7124
Fax : +82-31-496-7100
<http://www.hirose.co.kr/>

INDIA:

HIROSE ELECTRIC SINGAPORE PTE. LTD. BANGALORE LIAISON OFFICE
Unit No-403, 4th Floor, No-84, Barton Centre, Mahatma Gandhi (MG) Road, Bangalore 560 001, Karnataka, India
Phone : +91-80-4120 1907
Fax : +91-80-4120 9908
<http://www.hirose.com/sg/>

USA:

HIROSE ELECTRIC (U.S.A.), INC. SAN JOSE OFFICE
3255 Scott Boulevard, Building 7, Suite 101 Santa Clara, CA 95054
Phone : +1-408-253-9640
Fax : +1-408-253-9641
<http://www.hirose.com/us/>

THE NETHERLANDS:

HIROSE ELECTRIC EUROPE B.V.
Hogehillweg #8 1101 CC Amsterdam Z-0
Phone : +31-20-6557460
Fax : +31-20-6557469
<http://www.hirose.com/eu/>

GERMANY:

HIROSE ELECTRIC EUROPE B.V. HANOVER OFFICE
Bayernstr. 3, Haus C 30855 Langenhagen, Germany
Phone : +49-511 97 82 61 30
Fax : +49-511 97 82 61 35
<http://www.hirose.com/eu/>

CHINA:

HIROSE ELECTRIC (SHANGHAI) CO., LTD.
1601, Henderson Metropolitan, NO.300, East Nanjing Road, Huangpu District, Shanghai, China 200001
Phone : +86-21-6391-3355
Fax : +86-21-6391-3335
<http://www.hirose.com/cn/>

HONG KONG:

HIROSE ELECTRIC HONGKONG TRADING CO., LTD.
Room 1001, West Wing, Tsim Sha Tsui Centre, 66 Mody Road, Tsim Sha Tsui East, Kowloon, Hong Kong
Phone : +852-2803-5338
Fax : +852-2591-6560
<http://www.hirose.com/hk/>

SINGAPORE:

HIROSE ELECTRIC SINGAPORE PTE. LTD.
10 Anson Road #26-16, International Plaza 079903, Singapore
Phone : +65-6324-6113
Fax : +65-6324-6123
<http://www.hirose.com/sg/>

MALAYSIA:

HIROSE ELECTRIC SINGAPORE PTE. LTD.
1-10-07, Suntech @ Penang Cybercity (1164), Lintang Mayang Pasir 3, 11950, Bayan Baru, Penang, Malaysia.
Phone : +604-619-2564
Fax : +604-619-2574
<http://www.hirose.com/sg/>

USA:

HIROSE ELECTRIC (U.S.A.), INC. CHICAGO OFFICE
580 Waters Edge Lane, Suite 205 Lombard IL 60148
Phone : +1-630-282-6701
Mail : inquiries@hirose.com
<http://www.hirose.com/us/>

GERMANY:

HIROSE ELECTRIC EUROPE B.V. GERMAN BRANCH
Herzog-Carl-Strasse 4 D-73760 Ostfildern (Scharnhäuser Park)
Phone : +49-711-4560-02-1
Fax : +49-711-4560-02-299
<http://www.hirose.com/eu/>

FRANCE:

HIROSE ELECTRIC EUROPE B.V. PARIS OFFICE
Regus La Garenne Colombes, Place de La Belgique, 71 Boulevard National La Garenne Colombes, 92250, France
Phone : +33 (0) 1 7082 3170
Fax : +33 (1) 7082 3101
<http://www.hirose.com/eu/>

CHINA:

HIROSE ELECTRIC (SHANGHAI) CO., LTD. BEIJING BRANCH
A1001, Ocean International Center, Building 56# East 4th Ring Middle Road, ChaoYang District, Beijing, 100025
Phone : +86-10-5165-9332
Fax : +86-10-5908-1381
<http://www.hirose.com/cn/>

TAIWAN:

HIROSE ELECTRIC TAIWAN CO., LTD.
103 8F, No.87, Zhengzhou Rd., Taipei
Phone : +886-2-2555-7377
Fax : +886-2-2555-7350
<http://www.hirose.com/tw/>

INDIA:

HIROSE ELECTRIC SINGAPORE PTE. LTD. DELHI LIAISON OFFICE
Office NO.519, Regus-Green Boulevard, Level5, Tower C, Sec62, Plot B-9A, Block B, Noida, 201301, Uttar Pradesh, India
Phone : +91-12-660-8018
Fax : +91-120-4804949
<http://www.hirose.com/sg/>

THAILAND:

HIROSE ELECTRIC SINGAPORE PTE. LTD. BANGKOK OFFICE (REPRESENTATIVE OFFICE)
Unit 4703, 47th FL., 1 Empire Tower, South Sathorn Road, Yannawa, Sathorn, Bangkok 10120 Thailand
Phone : +66-2-686-1255
Fax : +66-2-686-3433
<http://www.hirose.com/sg/>

**HIROSE ELECTRIC CO.,LTD.**

2-6-3, Nakagawa Chuoh, Tsuzuki-Ku, Yokohama-Shi 224-8540, JAPAN
TEL: +81-45-620-3526 Fax: +81-45-591-3726
<http://www.hirose.com>
<http://www.hirose-connectors.com>

Компания «Океан Электроники» предлагает заключение долгосрочных отношений при поставках импортных электронных компонентов на взаимовыгодных условиях!

Наши преимущества:

- Поставка оригинальных импортных электронных компонентов напрямую с производств Америки, Европы и Азии, а так же с крупнейших складов мира;
- Широкая линейка поставок активных и пассивных импортных электронных компонентов (более 30 млн. наименований);
- Поставка сложных, дефицитных, либо снятых с производства позиций;
- Оперативные сроки поставки под заказ (от 5 рабочих дней);
- Экспресс доставка в любую точку России;
- Помощь Конструкторского Отдела и консультации квалифицированных инженеров;
- Техническая поддержка проекта, помощь в подборе аналогов, поставка прототипов;
- Поставка электронных компонентов под контролем ВП;
- Система менеджмента качества сертифицирована по Международному стандарту ISO 9001;
- При необходимости вся продукция военного и аэрокосмического назначения проходит испытания и сертификацию в лаборатории (по согласованию с заказчиком);
- Поставка специализированных компонентов военного и аэрокосмического уровня качества (Xilinx, Altera, Analog Devices, Intersil, Interpoint, Microsemi, Actel, Aeroflex, Peregrine, VPT, Syfer, Eurofarad, Texas Instruments, MS Kennedy, Miteq, Cobham, E2V, MA-COM, Hittite, Mini-Circuits, General Dynamics и др.);

Компания «Океан Электроники» является официальным дистрибьютором и эксклюзивным представителем в России одного из крупнейших производителей разъемов военного и аэрокосмического назначения «JONHON», а так же официальным дистрибьютором и эксклюзивным представителем в России производителя высокотехнологичных и надежных решений для передачи СВЧ сигналов «FORSTAR».



JONHON

«JONHON» (основан в 1970 г.)

Разъемы специального, военного и аэрокосмического назначения:

(Применяются в военной, авиационной, аэрокосмической, морской, железнодорожной, горно- и нефтедобывающей отраслях промышленности)

«FORSTAR» (основан в 1998 г.)

ВЧ соединители, коаксиальные кабели, кабельные сборки и микроволновые компоненты:

(Применяются в телекоммуникациях гражданского и специального назначения, в средствах связи, РЛС, а так же военной, авиационной и аэрокосмической отраслях промышленности).



Телефон: 8 (812) 309-75-97 (многоканальный)

Факс: 8 (812) 320-03-32

Электронная почта: ocean@oceanchips.ru

Web: <http://oceanchips.ru/>

Адрес: 198099, г. Санкт-Петербург, ул. Калинина, д. 2, корп. 4, лит. А