

**PLEASE CHECK WWW.MOLEX.COM FOR LATEST PART INFORMATION**

**Part Number:** [0003096061](#)  
**Status:** **Active**  
**Overview:** [standard\\_093](#)  
**Description:** 2.36mm (.093") Diameter Standard .093 Pin and Socket Receptacle Housing, 6 Circuits, Dual Row, Panel Mount, Black

**Documents:**

<a href="#">3D Model</a>	<a href="#">Product Specification PS-02-09 (PDF)</a>
<a href="#">Packaging Specification (PDF)</a>	<a href="#">Product Specification PS-43660-9999 (PDF)</a>
<a href="#">Drawing (PDF)</a>	<a href="#">RoHS Certificate of Compliance (PDF)</a>

**Agency Certification**

CSA	LR19980
UL	E29179

**General**

Product Family	Crimp Housings
Series	<a href="#">1261</a>
Comments	14.0A max. can be achieved when housing is used with 42477 or 42478 terminals
Overview	<a href="#">standard_093</a>
Product Name	Standard .093"

**Physical**

Circuits (maximum)	6
Color - Resin	Natural
Flammability	94V-2
Gender	Male
Glow-Wire Compliant	No
Lock to Mating Part	Yes
Material - Resin	Nylon
Number of Rows	2
Packaging Type	Bag
Panel Mount	Yes
Pitch - Mating Interface (in)	0.198 In
Pitch - Mating Interface (mm)	5.03 mm
Stackable	No
Temperature Range - Operating	-40°C to +105°C

**Electrical**

Current - Maximum per Contact	11A
-------------------------------	-----

**Material Info**

Old Part Number	1261RBK
-----------------	---------

**Reference - Drawing Numbers**

Packaging Specification	PK-1261-001
Product Specification	PS-02-09, PS-43660-9999
Sales Drawing	SD-1261-*

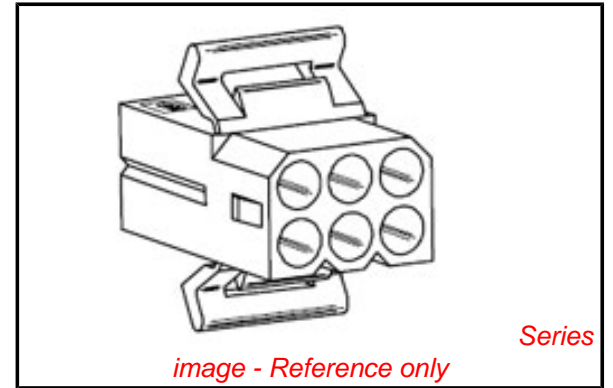

*image - Reference only*

**EU RoHS**

**ELV and RoHS Compliant**

**REACH SVHC**

Not Reviewed

**Halogen-Free**

**Status**

**Not Reviewed**

**Need more information on product environmental compliance?**

Email [productcompliance@molex.com](mailto:productcompliance@molex.com)  
 For a multiple part number RoHS Certificate of Compliance, [click here](#)

Please visit the [Contact Us](#) section for any non-product compliance questions.

**China RoHS**



**Search Parts in this Series**

[1261Series](#)

**Mates With**

[03-09-7062](#) , [3099](#)

**Use With**

[1189](#) Crimp Terminals, [1190](#) Crimp Terminals, [1376](#) Male PC Tail Terminals, [1377](#) Female PC Tail Terminals, [1380](#) Male Crimp Terminals, [1381](#) Female Crimp Terminals, [1433](#) Crimp Terminals, [1434](#) Male Crimp Terminals, [2151](#) , [2870](#) , [2871](#) , [4550](#) , [6271](#) , [42477](#) , [42478](#)

13 12 11 10 9 8 7 6 5 4 3 2 1

J  
I  
H  
G  
F  
E  
D  
C  
B  
A

J  
I  
H  
G  
F  
E  
D  
C  
B  
A

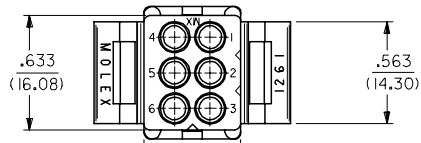

CIRCUIT I.D. (3 PL.)

OPTIONAL MOUNTING EAR (PREBENT SHOWN) & RIB, SEE DETAIL 3 & 4

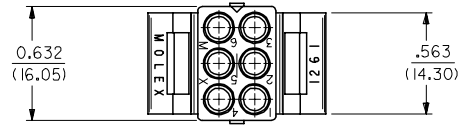
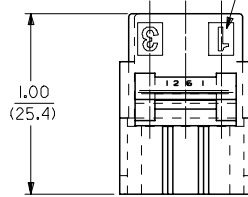
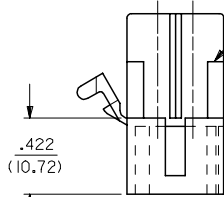
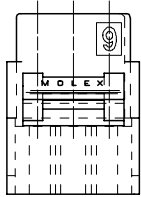

OPTIONAL MOUNTING EAR (PREBENT SHOWN) SEE DETAIL 3 & 4

OPTIONAL LOCK RAMP

CIRCUIT I.D. (3 PL.)

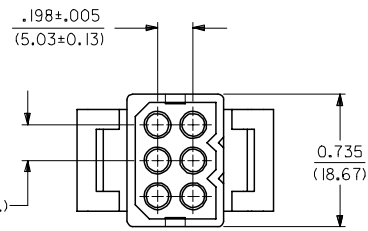
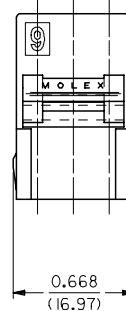
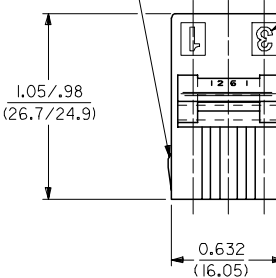
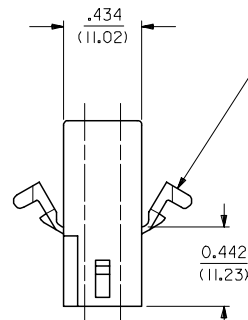

.198±.005 (5.03±0.13) (2 PL.)

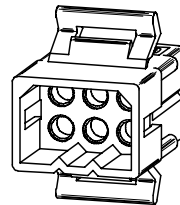

PLUG

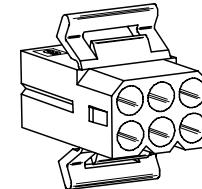
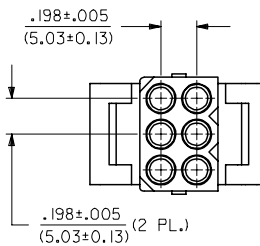

RECEPTACLE

<b>REVISED NOTES</b> EC NO: UCP2006-2424 DRAWN/PRD/DR 2006/06/08 CHKD: AEL/HAG 2006/06/08 APPR: FSM/TH 2006/06/09	<b>QUALITY SYMBOLS</b> ▽=0 ▽=0	<b>GENERAL TOLERANCES (UNLESS SPECIFIED)</b>		<b>DIMENSION STYLE</b> IN/MM	<b>SCALE</b> 2:1	<b>DESIGN UNITS</b> INCH	THIRD ANGLE PROJECTION	
		mm	INCH	DRAWN BY	DATE	TITLE	.093/(2.36) HOUSING, PLUG AND RECEPTACLE, 6 CKT., .198/(5.03)CTRS. MOLEX INCORPORATED	
		4 PLACES ± .007	± .007	GWC	11/6/89			
		3 PLACES ± .010	± .010	CHECKED BY	DATE			
2 PLACES ± 0.18	± 0.10	RW	11/6/89					
1 PLACE ± 0.25	± .007	APPROVED BY	DATE		MATERIAL NO. DOCUMENT NO. SHEET NO. SD-1261-* 1 OF 2			
ANGULAR ± 2 °		GWF	11/6/89					
DRAFT WHERE APPLICABLE MUST REMAIN WITHIN DIMENSIONS		SEE CHART		THIS DRAWING CONTAINS INFORMATION THAT IS PROPRIETARY TO MOLEX INCORPORATED AND SHOULD NOT BE USED WITHOUT WRITTEN PERMISSION				

12 11 10 9 8 7 6 5 4 3 2 1

13 12 11 10 9 8 7 6 5 4 3 2 1

**PLUG**

PART NO.	ENG. NO.
03-09-2061	I261-P
23-09-2061	I261-P-100
03-09-2062	I261-P1
23-09-2062	I261-P1-100
03-09-7061	I261-PBK
03-09-7062	I261-PIBK
27-09-2093	I261-PI-200
50-29-0099	I261-PI-300

**RECEPTACLE**

PART NO.	ENG. NO.
03-09-1061	I261-R
23-09-1061	I261-R-100
03-09-1062	I261-R1
23-09-1062	I261-R1-100
03-09-1063	I261-R2
23-09-1063	I261-R2-100
03-09-1064	I261-R3
27-09-1063	I261-R2-200
03-09-6064	I261-R3BK
03-09-6063	I261-R2BK
03-09-6062	I261-RIBK
03-09-6061	I261-RBK
50-29-1500	I261-R3-300

**LEGEND: PLUG**

I261-P\*\*\*-\*\*\*  
 P = PLUG  
 BLANK = PLUG WITH PREBENT MOUNTING EARS  
 I = PLUG WITHOUT MOUNTING EARS  
 COLOR: BLANK=NATURAL COLOR  
 AM=AMBER BK=BLACK BU=BLUE  
 BN=BROWN GY=GRAY GN=GREEN  
 OR=ORANGE RD=RED YW=YELLOW  
 MATERIAL: BLANK = NYLON 6/6, U.L. 94V-2  
 100 = POLYPROPYLENE, U.L. 94V-0  
 200 = NYLON 6/6, U.L. 94V-0, RED  
 300 = NYLON 6/6, U.L. 94V-2, BLACK  
 UV RESISTANT

**LEGEND: RECEPTACLE**

I261-R\*\*\*-\*\*\*  
 R = RECEPTACLE  
 BLANK = WITH STD. MOUNTING EARS, WITH LOCK RAMP  
 1 = WITH STD. MOUNTING EARS, WITHOUT LOCK RAMP  
 2 = WITHOUT MOUNTING EARS, WITHOUT LOCK RAMP  
 3 = WITHOUT MOUNTING EARS, WITH LOCK RAMP  
 4 = WITH PREBENT MOUNTING EARS, WITH LOCK RAMP  
 5 = WITH PREBENT MOUNTING EARS, WITHOUT LOCK RAMP  
 COLOR: BLANK=NATURAL COLOR  
 AM=AMBER BK=BLACK BU=BLUE  
 BN=BROWN GY=GRAY GN=GREEN  
 OR=ORANGE RD=RED YW=YELLOW  
 MATERIAL: BLANK = NYLON 6/6, U.L. 94V-2  
 100 = POLYPROPYLENE, U.L. 94V-0  
 200 = NYLON 6/6, U.L. 94V-0, RED  
 300 = NYLON 6/6, U.L. 94V-2, BLACK  
 UV RESISTANT

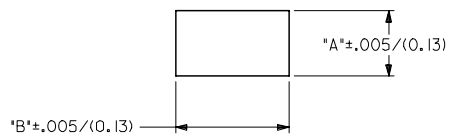
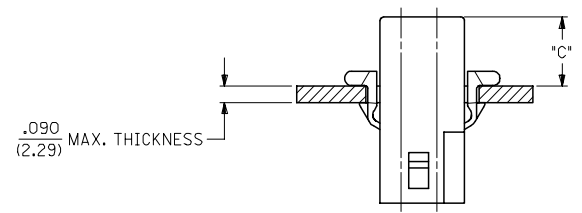

MOUNTING HOLE CUTOUT

HOUSING	DIM. 'A'	DIM. 'B'	DIM. 'C' (STD. EAR)	DIM. 'C' (PREBENT)
PLUG	.750/(19.05)	.695/(17.65)	.39/(9.9)	.40/(10.1)
RECEPTACLE	.718/(18.24)	.600/(15.24)	.40/(10.1)	.41/(10.3)

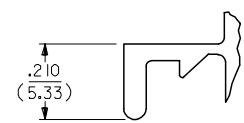

DETAIL 3

.093/(2.36) STANDARD MOUNTING EAR  
 (SCALE 4:1)

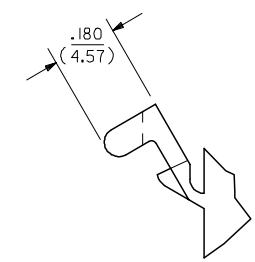
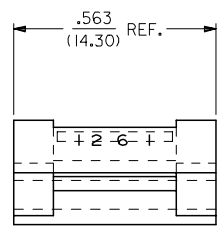

DETAIL 4

.093/(2.36) PREBENT MOUNTING EAR  
 (SCALE 4:1)

**NOTES:**

1. MATERIAL: SEE LEGEND
2. FINISH: NONE.
3. PRODUCT SPECIFICATION: PS-43660-9999
4. PACKAGING INFORMATION: PK-1261-001
5. HOUSINGS FOR USE WITH MOLEX .093/(2.36) PIN AND SOCKET TERMINALS.
6. CIRCUIT I.D. NUMBERS ON SIDE OF HOUSING APPEAR ON PARTS FROM TOOLS BUILT AFTER 9/3/91.
7. WHERE DENOTED IN CHART, TOOLS ARE BUILT WITH PREBENT MOUNTING EARS PER DETAIL 4 AND SUPERSEDE ALL TOOLS PREVIOUSLY BUILT WITH THE STANDARD MOUNTING EAR.
8. TEXT AND CIRCUIT IDENTIFIERS ARE SHOWN IN APPROXIMATE LOCATION BUT MAY VARY TO ACCOMMODATE TOOLING.

UPDATED NOTES EC NO: UCP2006-2424 DRAWN: P. DDER 2006/06/08 CHKD: AELHAG 2006/06/08 APPR: FSM TH 2006/06/09	QUALITY SYMBOLS ▽=0 ▽=0	GENERAL TOLERANCES (UNLESS SPECIFIED) mm INCH 4 PLACES ± .007 ± .0007 3 PLACES ± .010 ± .0010 2 PLACES ± 0.18 ± .010 1 PLACE ± 0.25 ± .010 ANGULAR ± 2 °	DIMENSION STYLE IN/MM DRAWN BY DATE GJC 11/10/89 CHECKED BY DATE RW 11/10/89 APPROVED BY DATE GWF 11/10/89	SCALE 4:1 DESIGN UNITS INCH THIRD ANGLE PROJECTION	MATERIAL NO. SEE CHART DOCUMENT NO. SD-1261-* SHEET NO. 2 OF 2
		DRAFT WHERE APPLICABLE MUST REMAIN WITHIN DIMENSIONS		MOLEX INCORPORATED	

12 11 10 9 8 7 6 5 4 3 2 1

Компания «Океан Электроники» предлагает заключение долгосрочных отношений при поставках импортных электронных компонентов на взаимовыгодных условиях!

Наши преимущества:

- Поставка оригинальных импортных электронных компонентов напрямую с производств Америки, Европы и Азии, а так же с крупнейших складов мира;
- Широкая линейка поставок активных и пассивных импортных электронных компонентов (более 30 млн. наименований);
- Поставка сложных, дефицитных, либо снятых с производства позиций;
- Оперативные сроки поставки под заказ (от 5 рабочих дней);
- Экспресс доставка в любую точку России;
- Помощь Конструкторского Отдела и консультации квалифицированных инженеров;
- Техническая поддержка проекта, помощь в подборе аналогов, поставка прототипов;
- Поставка электронных компонентов под контролем ВП;
- Система менеджмента качества сертифицирована по Международному стандарту ISO 9001;
- При необходимости вся продукция военного и аэрокосмического назначения проходит испытания и сертификацию в лаборатории (по согласованию с заказчиком);
- Поставка специализированных компонентов военного и аэрокосмического уровня качества (Xilinx, Altera, Analog Devices, Intersil, Interpoint, Microsemi, Actel, Aeroflex, Peregrine, VPT, Syfer, Eurofarad, Texas Instruments, MS Kennedy, Miteq, Cobham, E2V, MA-COM, Hittite, Mini-Circuits, General Dynamics и др.);

Компания «Океан Электроники» является официальным дистрибьютором и эксклюзивным представителем в России одного из крупнейших производителей разъемов военного и аэрокосмического назначения «JONHON», а так же официальным дистрибьютором и эксклюзивным представителем в России производителя высокотехнологичных и надежных решений для передачи СВЧ сигналов «FORSTAR».



## JONHON

«JONHON» (основан в 1970 г.)

Разъемы специального, военного и аэрокосмического назначения:

(Применяются в военной, авиационной, аэрокосмической, морской, железнодорожной, горно- и нефтедобывающей отраслях промышленности)

«FORSTAR» (основан в 1998 г.)

ВЧ соединители, коаксиальные кабели, кабельные сборки и микроволновые компоненты:

(Применяются в телекоммуникациях гражданского и специального назначения, в средствах связи, РЛС, а так же военной, авиационной и аэрокосмической отраслях промышленности).



Телефон: 8 (812) 309-75-97 (многоканальный)

Факс: 8 (812) 320-03-32

Электронная почта: [ocean@oceanchips.ru](mailto:ocean@oceanchips.ru)

Web: <http://oceanchips.ru/>

Адрес: 198099, г. Санкт-Петербург, ул. Калинина, д. 2, корп. 4, лит. А