



RF Power LDMOS Transistors

N-Channel Enhancement-Mode Lateral MOSFETs

These 32 W RF power LDMOS transistors are designed for cellular base station applications requiring very wide instantaneous bandwidth capability covering the frequency range of 1805 to 1995 MHz.

1800 MHz

- Typical Single-Carrier W-CDMA Performance: $V_{DD} = 28$ Vdc, $I_{DQ} = 1000$ mA, $P_{out} = 32$ W Avg., Input Signal PAR = 9.9 dB @ 0.01% Probability on CCDF.

| Frequency | G_{ps} (dB) | η_D (%) | Output PAR (dB) | ACPR (dBc) | IRL (dB) |
|-----------|---------------|--------------|-----------------|------------|----------|
| 1805 MHz | 19.6 | 32.1 | 7.2 | -34.7 | -12 |
| 1840 MHz | 20.1 | 32.1 | 7.2 | -35.0 | -17 |
| 1880 MHz | 19.9 | 31.6 | 7.2 | -35.4 | -12 |

1900 MHz

- Typical Single-Carrier W-CDMA Performance: $V_{DD} = 28$ Vdc, $I_{DQ} = 1000$ mA, $P_{out} = 32$ W Avg., Input Signal PAR = 9.9 dB @ 0.01% Probability on CCDF.

| Frequency | G_{ps} (dB) | η_D (%) | Output PAR (dB) | ACPR (dBc) | IRL (dB) |
|-----------|---------------|--------------|-----------------|------------|----------|
| 1930 MHz | 21.0 | 32.2 | 7.5 | -34.4 | -17 |
| 1960 MHz | 21.3 | 32.2 | 7.4 | -34.4 | -19 |
| 1995 MHz | 21.6 | 32.9 | 7.1 | -33.9 | -12 |

Features

- Designed for Wide Instantaneous Bandwidth Applications
- Greater Negative Gate-Source Voltage Range for Improved Class C Operation
- Able to Withstand Extremely High Output VSWR and Broadband Operating Conditions
- Optimized for Doherty Applications

A2T18S160W31SR3
A2T18S160W31GSR3

1805–1995 MHz, 32 W AVG., 28 V
AIRFAST RF POWER LDMOS
TRANSISTORS

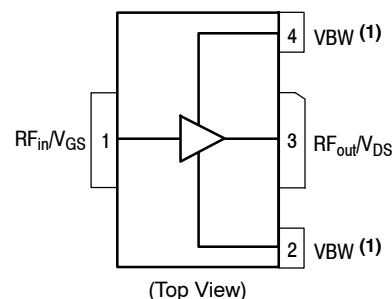
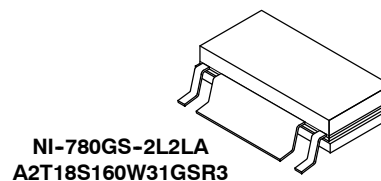
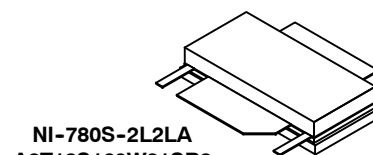

Figure 1. Pin Connections

- Device can operate with the V_{DD} current supplied through pin 2 or pin 4 alone.

Table 1. Maximum Ratings

| Rating | Symbol | Value | Unit |
|--|-----------|-------------|-----------|
| Drain-Source Voltage | V_{DSS} | -0.5, +65 | Vdc |
| Gate-Source Voltage | V_{GS} | -6.0, +10 | Vdc |
| Operating Voltage | V_{DD} | 32, +0 | Vdc |
| Storage Temperature Range | T_{stg} | -65 to +150 | °C |
| Case Operating Temperature Range | T_C | -40 to +125 | °C |
| Operating Junction Temperature Range (1,2) | T_J | -40 to +225 | °C |
| CW Operation @ $T_C = 25^\circ\text{C}$ Derate above 25°C | CW | 185 1.0 | W W/°C |

Table 2. Thermal Characteristics

| Characteristic | Symbol | Value (2,3) | Unit |
|---|-----------------|-------------|------|
| Thermal Resistance, Junction to Case Case Temperature 76°C , 32 W CW, 28 Vdc, $I_{DQ} = 1000\text{ mA}$, 1840 MHz | $R_{\theta JC}$ | 0.36 | °C/W |

Table 3. ESD Protection Characteristics

| Test Methodology | Class |
|---------------------------------------|-------|
| Human Body Model (per JESD22-A114) | 2 |
| Machine Model (per EIA/JESD22-A115) | B |
| Charge Device Model (per JESD22-C101) | IV |

Table 4. Electrical Characteristics ($T_A = 25^\circ\text{C}$ unless otherwise noted)

| Characteristic | Symbol | Min | Typ | Max | Unit |
|----------------|--------|-----|-----|-----|------|
|----------------|--------|-----|-----|-----|------|

Off Characteristics

| | | | | | |
|---|-----------|---|---|----|-----------------|
| Zero Gate Voltage Drain Leakage Current ($V_{DS} = 65\text{ Vdc}$, $V_{GS} = 0\text{ Vdc}$) | I_{DSS} | — | — | 10 | μAdc |
| Zero Gate Voltage Drain Leakage Current ($V_{DS} = 32\text{ Vdc}$, $V_{GS} = 0\text{ Vdc}$) | I_{DSS} | — | — | 5 | μAdc |
| Gate-Source Leakage Current ($V_{GS} = 5\text{ Vdc}$, $V_{DS} = 0\text{ Vdc}$) | I_{GSS} | — | — | 1 | μAdc |

On Characteristics

| | | | | | |
|--|--------------|-----|------|-----|-----|
| Gate Threshold Voltage ($V_{DS} = 10\text{ Vdc}$, $I_D = 160\ \mu\text{Adc}$) | $V_{GS(th)}$ | 1.2 | 1.8 | 2.2 | Vdc |
| Gate Quiescent Voltage ($V_{DD} = 28\text{ Vdc}$, $I_D = 1000\text{ mAdc}$, Measured in Functional Test) | $V_{GS(Q)}$ | 2.1 | 2.6 | 3.1 | Vdc |
| Drain-Source On-Voltage ($V_{GS} = 10\text{ Vdc}$, $I_D = 1.6\text{ Adc}$) | $V_{DS(on)}$ | 0.1 | 0.14 | 0.3 | Vdc |

Functional Tests (4,5) (In Freescale Test Fixture, 50 ohm system) $V_{DD} = 28\text{ Vdc}$, $I_{DQ} = 1000\text{ mA}$, $P_{out} = 32\text{ W Avg.}$, $f = 1880\text{ MHz}$, Single-Carrier W-CDMA, IQ Magnitude Clipping, Input Signal PAR = 9.9 dB @ 0.01% Probability on CCDF. ACPR measured in 3.84 MHz Channel Bandwidth @ $\pm 5\text{ MHz}$ Offset.

| | | | | | |
|--|----------|------|-------|-------|-----|
| Power Gain | G_{ps} | 18.5 | 19.9 | 21.5 | dB |
| Drain Efficiency | η_D | 27.0 | 31.6 | — | % |
| Output Peak-to-Average Ratio @ 0.01% Probability on CCDF | PAR | 6.7 | 7.2 | — | dB |
| Adjacent Channel Power Ratio | ACPR | — | -35.4 | -32.0 | dBc |
| Input Return Loss | IRL | — | -12 | -6.5 | dB |

1. Continuous use at maximum temperature will affect MTTF.
2. MTTF calculator available at <http://www.freescale.com/rf/calculators>.
3. Refer to [AN1955](#), *Thermal Measurement Methodology of RF Power Amplifiers*. Go to <http://www.freescale.com/rf> and search for AN1955.
4. Part internally matched both on input and output.
5. Measurements made with device in straight lead configuration, before any lead forming operation is applied. Lead forming is used for gull wing (GS) parts.

(continued)

Table 4. Electrical Characteristics ($T_A = 25^\circ\text{C}$ unless otherwise noted) (continued)

| Characteristic | Symbol | Min | Typ | Max | Unit |
|--|-----------------------|-----|-------|-----|-------|
| Load Mismatch (In Freescale Test Fixture, 50 ohm system) $I_{DQ} = 1000\text{ mA}$, $f = 1840\text{ MHz}$ | | | | | |
| VSWR 10:1 at 32 Vdc, 173 W CW Output Power (3 dB Input Overdrive from 129 W CW Rated Power) | No Device Degradation | | | | |
| Typical Performance (In Freescale Test Fixture, 50 ohm system) $V_{DD} = 28\text{ Vdc}$, $I_{DQ} = 1000\text{ mA}$, 1805–1880 MHz Bandwidth | | | | | |
| P_{out} @ 1 dB Compression Point, CW | P1dB | — | 129 | — | W |
| AM/PM (Maximum value measured at the P3dB compression point across the 1805–1880 MHz frequency range.) | Φ | — | -15 | — | ° |
| VBW Resonance Point (IMD Third Order Intermodulation Inflection Point) | VBW _{res} | — | 110 | — | MHz |
| Gain Flatness in 75 MHz Bandwidth @ $P_{out} = 32\text{ W Avg.}$ | G _F | — | 0.5 | — | dB |
| Gain Variation over Temperature (-30°C to +85°C) | ΔG | — | 0.006 | — | dB/°C |
| Output Power Variation over Temperature (-30°C to +85°C) (1) | $\Delta P1dB$ | — | 0.005 | — | dB/°C |

Table 5. Ordering Information

| Device | Tape and Reel Information | Package |
|------------------|---|----------------|
| A2T18S160W31SR3 | R3 Suffix = 250 Units, 44 mm Tape Width, 13-inch Reel | NI-780S-2L2LA |
| A2T18S160W31GSR3 | | NI-780GS-2L2LA |

1. Exceeds recommended operating conditions. See CW operation data in Maximum Ratings table.

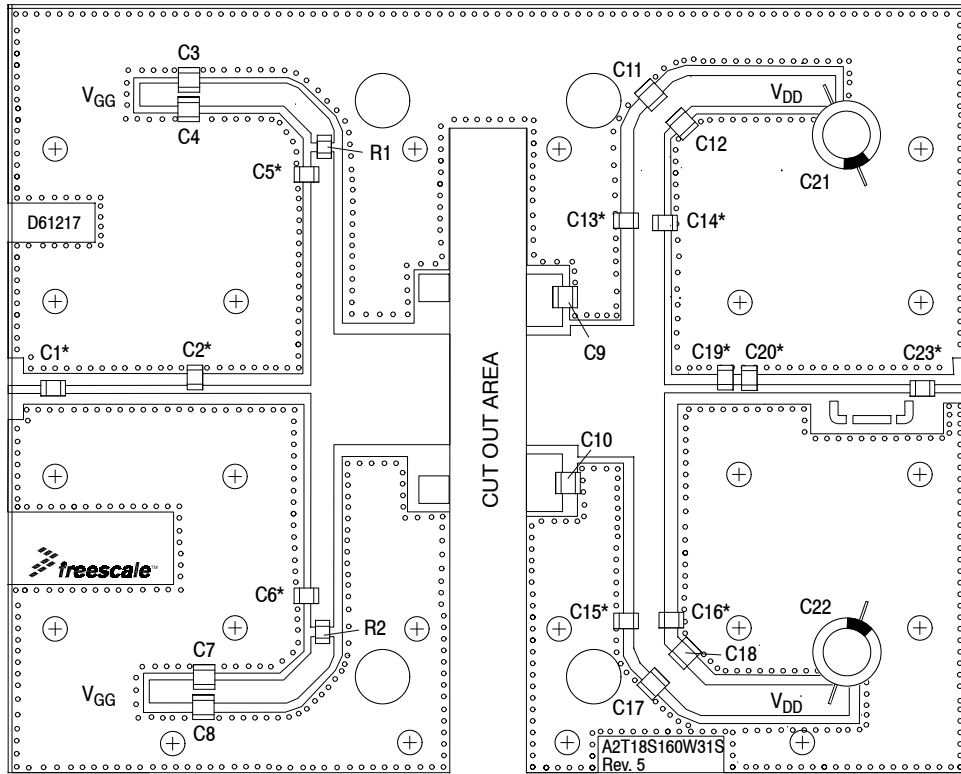

*C1, C2, C5, C6, C13, C14, C15, C16, C19, C20, and C23 are mounted vertically.

Figure 2. A2T18S160W31SR3 Test Circuit Component Layout

Table 6. A2T18S160W31SR3 Test Circuit Component Designations and Values

| Part | Description | Part Number | Manufacturer |
|---|---|----------------------|--------------|
| C1, C13, C14, C15, C16, C23 | 8.2 pF Chip Capacitors | ATC100B8R2CT500XT | ATC |
| C2 | 1.7 pF Chip Capacitor | ATC100B1R7BT500XT | ATC |
| C3, C4, C7, C8, C9, C10, C11, C12, C17, C18 | 10 μ F Chip Capacitors | GRM32ER61H106KA12L | Murata |
| C5, C6 | 9.1 pF Chip Capacitors | ATC100B9R1CT500XT | ATC |
| C19 | 2.2 pF Chip Capacitor | ATC100B2R2JT500XT | ATC |
| C20 | 0.5 pF Chip Capacitor | ATC100B0R5BT500XT | ATC |
| C21, C22 | 470 μ F, 63 V Electrolytic Capacitors | MCGPR63V477M13X26-RH | Multicomp |
| R1, R2 | 2.37 Ω , 1/4 W Chip Resistors | CRCW12062R37FNEA | Vishay |
| PCB | Rogers RO4350B, 0.020", $\epsilon_r = 3.66$ | D61217 | MTL |

TYPICAL CHARACTERISTICS — 1805–1880 MHz

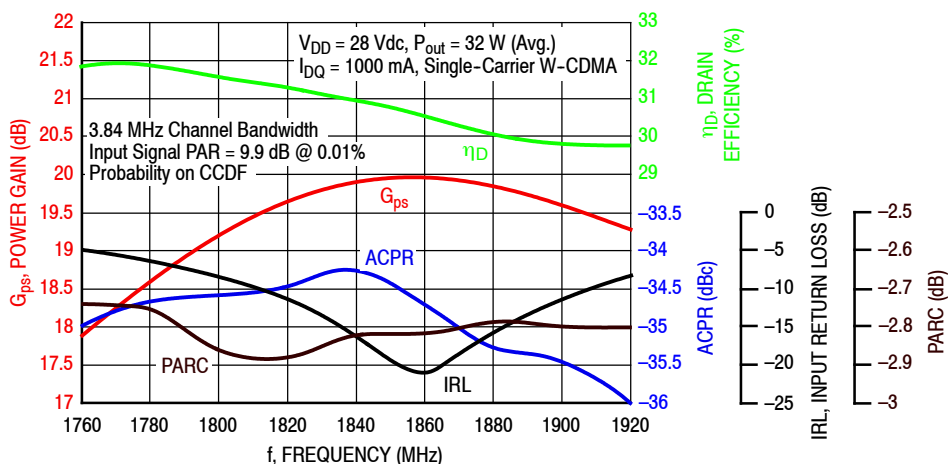

Figure 3. Single-Carrier Output Peak-to-Average Ratio Compression (PARC) Broadband Performance @ P_{out} = 32 Watts Avg.

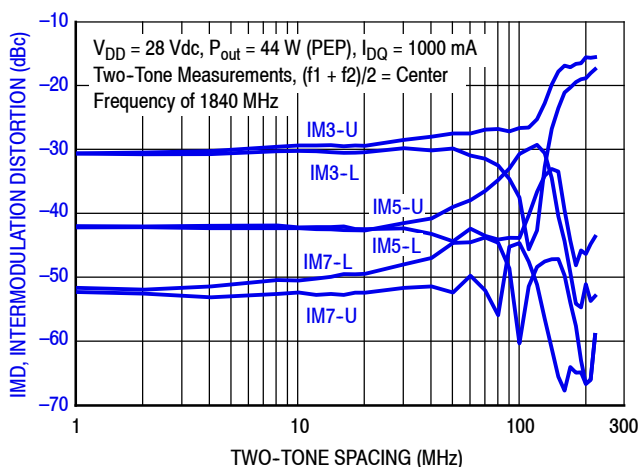

Figure 4. Intermodulation Distortion Products versus Two-Tone Spacing

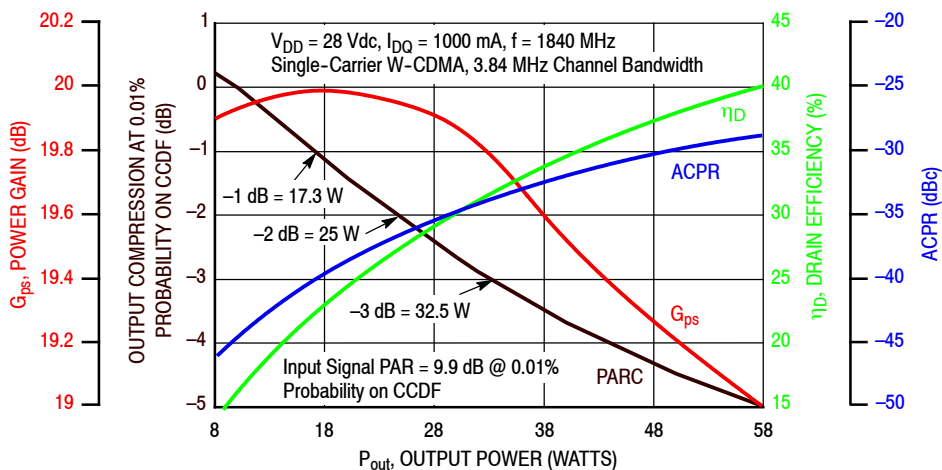

Figure 5. Output Peak-to-Average Ratio Compression (PARC) versus Output Power

TYPICAL CHARACTERISTICS — 1805–1880 MHz

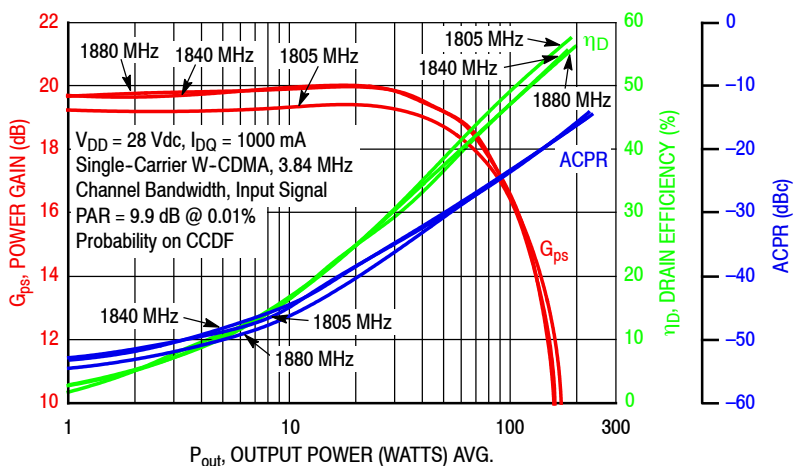

Figure 6. Single-Carrier W-CDMA Power Gain, Drain Efficiency and ACPR versus Output Power

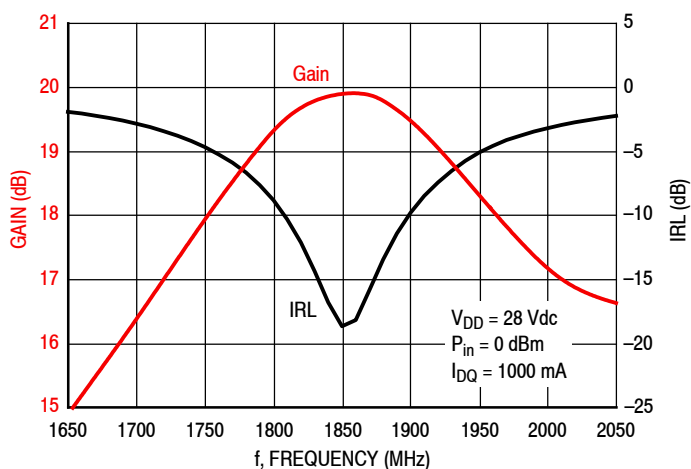

Figure 7. Broadband Frequency Response

Table 7. Load Pull Performance — Maximum Power Tuning
 $V_{DD} = 28 \text{ Vdc}$, $I_{DQ} = 1041 \text{ mA}$, Pulsed CW, $10 \mu\text{sec(on)}$, 10% Duty Cycle

| f (MHz) | $Z_{\text{source}} (\Omega)$ | $Z_{\text{in}} (\Omega)$ | Max Output Power | | | | | |
|---------|------------------------------|--------------------------|----------------------------------|-----------|-------|-----|--------------|-----------|
| | | | P1dB | | | | | |
| | | | $Z_{\text{load}}^{(1)} (\Omega)$ | Gain (dB) | (dBm) | (W) | η_D (%) | AM/PM (°) |
| 1805 | $0.77 - j2.95$ | $0.81 + j3.12$ | $1.85 - j3.49$ | 19.0 | 51.9 | 156 | 50.2 | -9 |
| 1840 | $0.80 - j3.23$ | $0.93 + j3.34$ | $1.93 - j3.61$ | 19.0 | 52.0 | 157 | 50.4 | -11 |
| 1880 | $1.00 - j3.43$ | $1.14 + j3.63$ | $2.03 - j3.75$ | 19.0 | 51.8 | 150 | 49.3 | -11 |

| f (MHz) | $Z_{\text{source}} (\Omega)$ | $Z_{\text{in}} (\Omega)$ | Max Output Power | | | | | |
|---------|------------------------------|--------------------------|----------------------------------|-----------|-------|-----|--------------|-----------|
| | | | P3dB | | | | | |
| | | | $Z_{\text{load}}^{(2)} (\Omega)$ | Gain (dB) | (dBm) | (W) | η_D (%) | AM/PM (°) |
| 1805 | $0.77 - j2.95$ | $0.75 + j3.23$ | $1.89 - j3.56$ | 17.0 | 53.0 | 199 | 54.2 | -13 |
| 1840 | $0.80 - j3.23$ | $0.86 + j3.47$ | $1.96 - j3.58$ | 17.0 | 53.0 | 200 | 55.0 | -15 |
| 1880 | $1.00 - j3.43$ | $1.05 + j3.80$ | $2.03 - j3.43$ | 17.4 | 52.9 | 197 | 56.3 | -15 |

(1) Load impedance for optimum P1dB power.

(2) Load impedance for optimum P3dB power.

 Z_{source} = Measured impedance presented to the input of the device at the package reference plane.

 Z_{in} = Impedance as measured from gate contact to ground.

 Z_{load} = Measured impedance presented to the output of the device at the package reference plane.

Table 8. Load Pull Performance — Maximum Drain Efficiency Tuning
 $V_{DD} = 28 \text{ Vdc}$, $I_{DQ} = 1041 \text{ mA}$, Pulsed CW, $10 \mu\text{sec(on)}$, 10% Duty Cycle

| f (MHz) | $Z_{\text{source}} (\Omega)$ | $Z_{\text{in}} (\Omega)$ | Max Drain Efficiency | | | | | |
|---------|------------------------------|--------------------------|----------------------------------|-----------|-------|-----|--------------|-----------|
| | | | P1dB | | | | | |
| | | | $Z_{\text{load}}^{(1)} (\Omega)$ | Gain (dB) | (dBm) | (W) | η_D (%) | AM/PM (°) |
| 1805 | $0.77 - j2.95$ | $0.82 + j3.23$ | $3.67 - j0.62$ | 22.5 | 49.3 | 85 | 61.0 | -10 |
| 1840 | $0.80 - j3.23$ | $0.87 + j3.45$ | $2.54 - j0.27$ | 23.1 | 49.3 | 85 | 62.6 | -11 |
| 1880 | $1.00 - j3.43$ | $1.07 + j3.82$ | $2.12 - j0.54$ | 23.0 | 49.7 | 93 | 66.7 | -14 |

| f (MHz) | $Z_{\text{source}} (\Omega)$ | $Z_{\text{in}} (\Omega)$ | Max Drain Efficiency | | | | | |
|---------|------------------------------|--------------------------|----------------------------------|-----------|-------|-----|--------------|-----------|
| | | | P3dB | | | | | |
| | | | $Z_{\text{load}}^{(2)} (\Omega)$ | Gain (dB) | (dBm) | (W) | η_D (%) | AM/PM (°) |
| 1805 | $0.77 - j2.95$ | $0.81 + j3.37$ | $3.49 - j0.50$ | 20.6 | 50.6 | 115 | 67.0 | -16 |
| 1840 | $0.80 - j3.23$ | $0.90 + j3.56$ | $2.96 - j0.69$ | 20.6 | 50.9 | 124 | 68.1 | -17 |
| 1880 | $1.00 - j3.43$ | $1.12 + j3.91$ | $2.66 - j0.75$ | 20.7 | 51.0 | 126 | 70.4 | -20 |

(1) Load impedance for optimum P1dB efficiency.

(2) Load impedance for optimum P3dB efficiency.

 Z_{source} = Measured impedance presented to the input of the device at the package reference plane.

 Z_{in} = Impedance as measured from gate contact to ground.

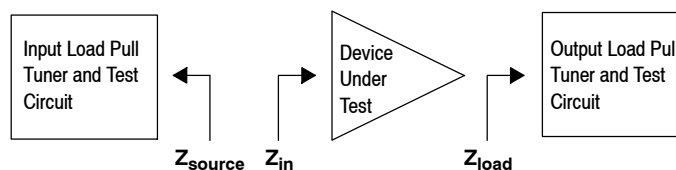
 Z_{load} = Measured impedance presented to the output of the device at the package reference plane.

P1dB – TYPICAL LOAD PULL CONTOURS — 1840 MHz

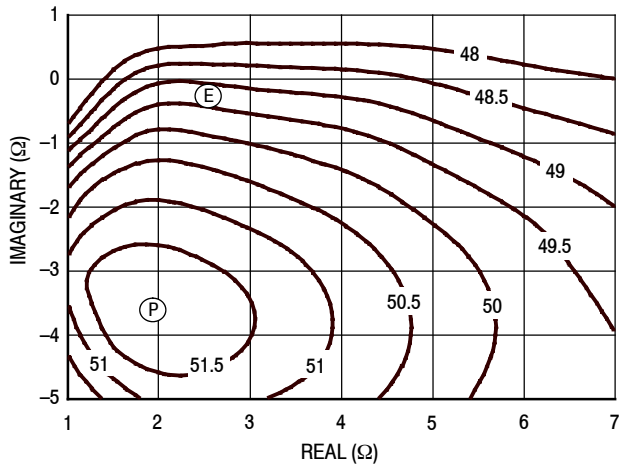

Figure 8. P1dB Load Pull Output Power Contours (dBm)

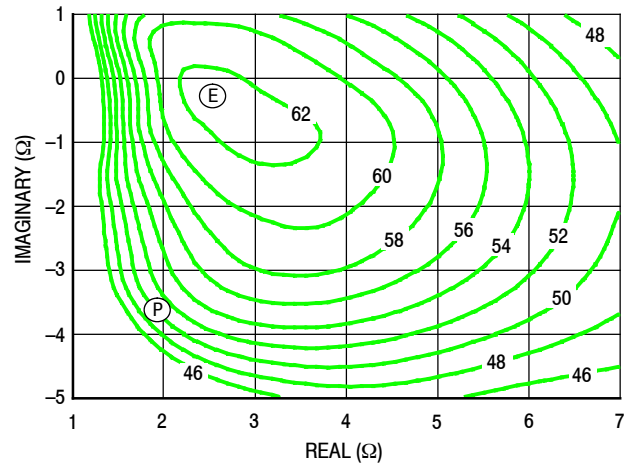

Figure 9. P1dB Load Pull Efficiency Contours (%)

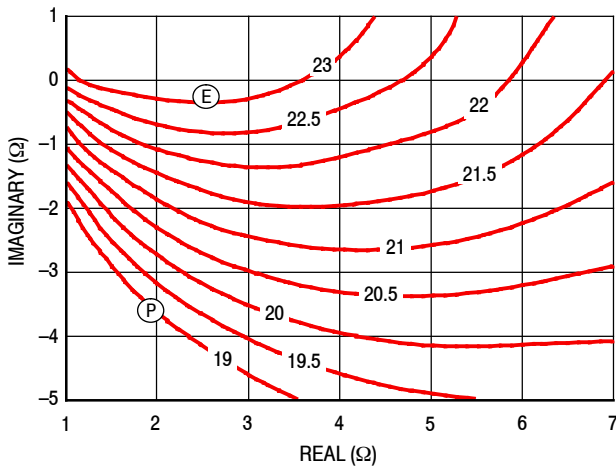

Figure 10. P1dB Load Pull Gain Contours (dB)

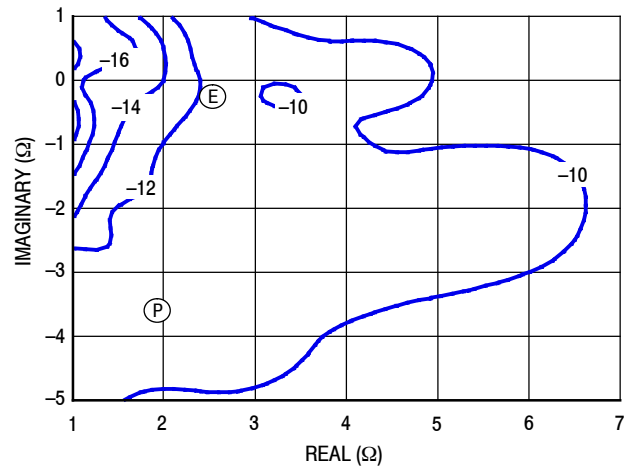

Figure 11. P1dB Load Pull AM/PM Contours (°)

NOTE: (P) = Maximum Output Power
(E) = Maximum Drain Efficiency

- Gain
- Drain Efficiency
- Linearity
- Output Power

P3dB – TYPICAL LOAD PULL CONTOURS — 1840 MHz

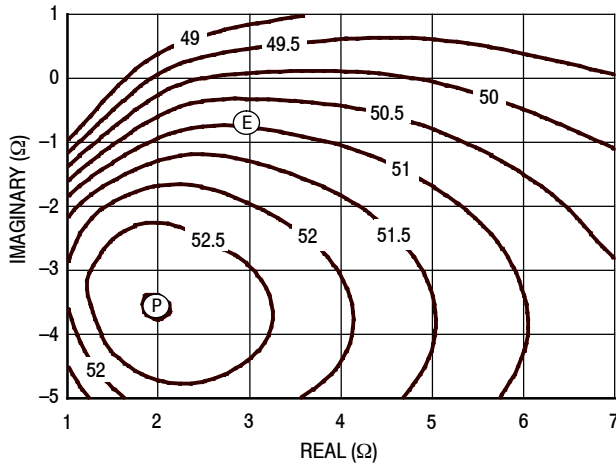

Figure 12. P3dB Load Pull Output Power Contours (dBm)

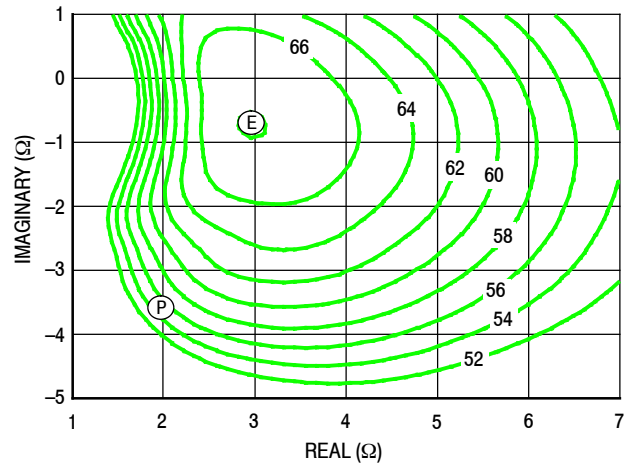

Figure 13. P3dB Load Pull Efficiency Contours (%)

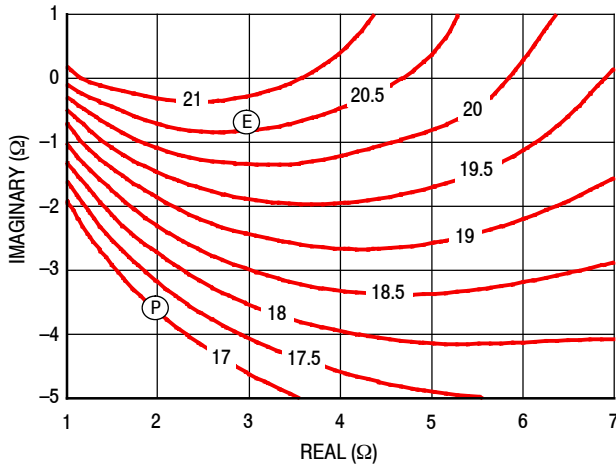

Figure 14. P3dB Load Pull Gain Contours (dB)

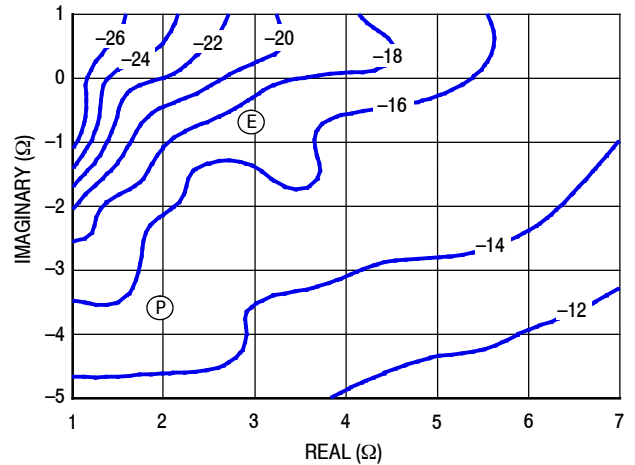
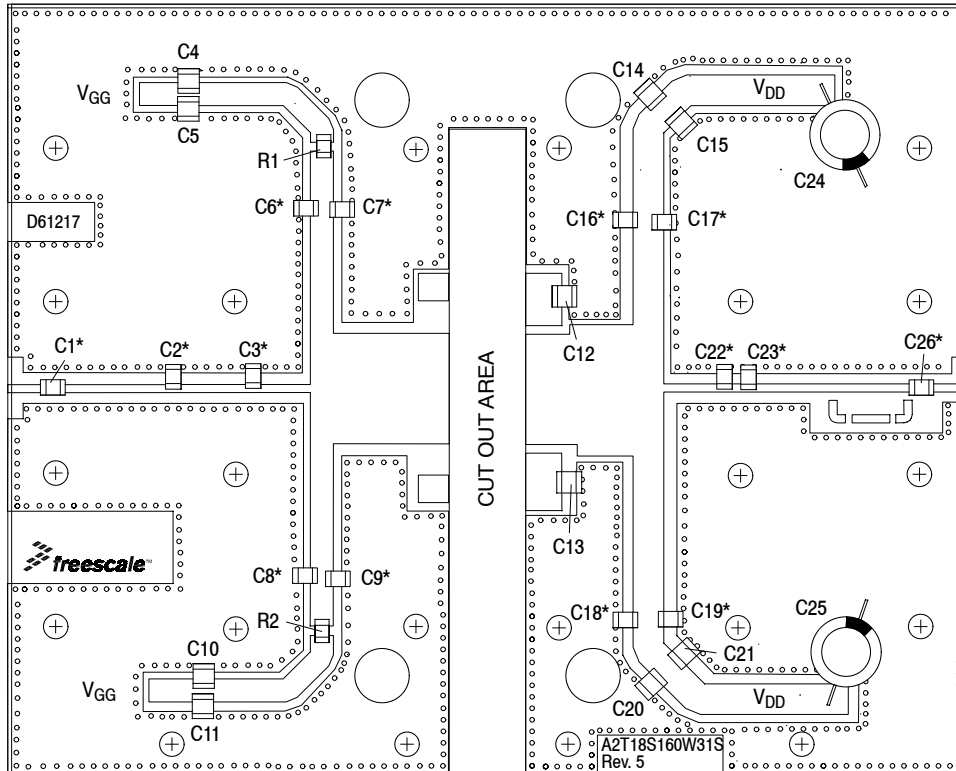

Figure 15. P3dB Load Pull AM/PM Contours (°)

NOTE: (P) = Maximum Output Power
(E) = Maximum Drain Efficiency

- Gain
- Drain Efficiency
- Linearity
- Output Power



*C1, C2, C3, C6, C7, C8, C9, C16, C17, C18, C19, C22, C23, and C26 are mounted vertically.

Figure 16. A2T18S160W31SR3 Test Circuit Component Layout — 1930–1995 MHz

Table 9. A2T18S160W31SR3 Test Circuit Component Designations and Values — 1930–1995 MHz

| Part | Description | Part Number | Manufacturer |
|--|---|----------------------|--------------|
| C1, C6, C7, C8, C9, C16, C17, C18, C19, C26 | 8.2 pF Chip Capacitors | ATC100B8R2CT500XT | ATC |
| C2 | 0.8 pF Chip Capacitor | ATC100B0R8BT500XT | ATC |
| C3 | 1.0 pF Chip Capacitor | ATC100B1R0BT500XT | ATC |
| C4, C5, C10, C11, C12, C13, C14, C15, C20, C21 | 10 μ F Chip Capacitors | GRM32ER61H106KA12L | Murata |
| C22 | 2.2 pF Chip Capacitor | ATC100B2R2JT500XT | ATC |
| C23 | 0.5 pF Chip Capacitor | ATC100B0R5BT500XT | ATC |
| C24, C25 | 470 μ F, 63 V Electrolytic Capacitors | MCGPR63V477M13X26-RH | Multicomp |
| R1, R2 | 2.37 Ω , 1/4 W Chip Resistors | CRCW12062R37FNEA | Vishay |
| PCB | Rogers RO4350B, 0.020", $\epsilon_r = 3.66$ | D61217 | MTL |

TYPICAL CHARACTERISTICS — 1930–1995 MHz

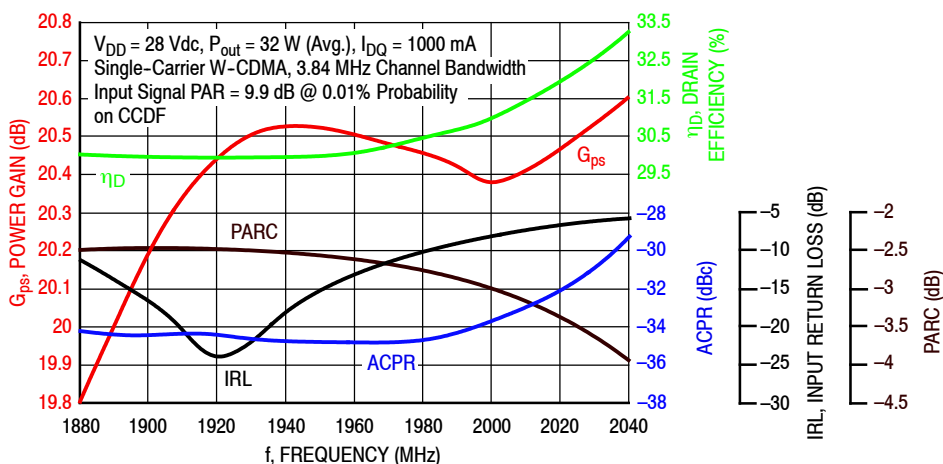

Figure 17. Single-Carrier Output Peak-to-Average Ratio Compression (PARC) Broadband Performance @ $P_{out} = 32$ Watts Avg.

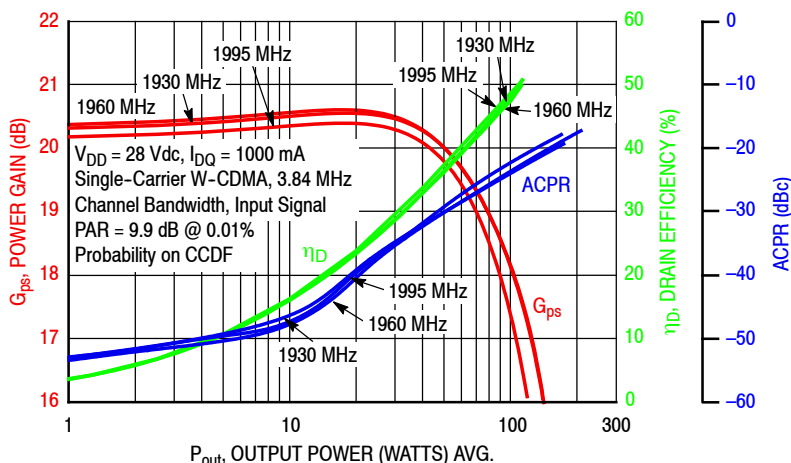

Figure 18. Single-Carrier W-CDMA Power Gain, Drain Efficiency and ACPR versus Output Power

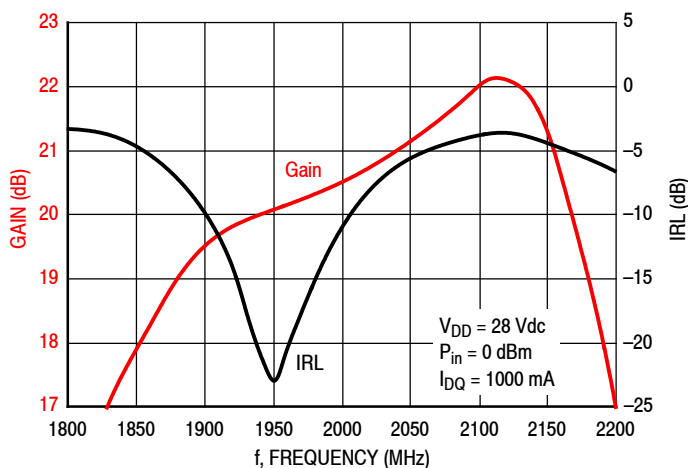

Figure 19. Broadband Frequency Response

Table 10. Load Pull Performance — Maximum Power Tuning
 $V_{DD} = 28 \text{ Vdc}$, $I_{DQ} = 1044 \text{ mA}$, Pulsed CW, $10 \mu\text{sec}(\text{on})$, 10% Duty Cycle

| f (MHz) | Z_{source} (Ω) | Z_{in} (Ω) | Max Output Power | | | | | |
|------------|-------------------------------------|---------------------------------|---|-----------|-------|-----|-----------------|-----------------------|
| | | | P1dB | | | | | |
| | | | $Z_{\text{load}}^{(1)}$ (Ω) | Gain (dB) | (dBm) | (W) | η_D (%) | AM/PM ($^\circ$) |
| 1930 | $1.28 - j3.84$ | $1.45 + j4.15$ | $1.49 - j2.77$ | 20.3 | 52.2 | 166 | 56.2 | -10 |
| 1960 | $1.53 - j4.20$ | $1.80 + j4.46$ | $1.49 - j2.90$ | 20.4 | 52.4 | 173 | 57.9 | -11 |
| 1995 | $2.15 - j4.41$ | $2.49 + j4.79$ | $1.54 - j3.27$ | 20.4 | 52.3 | 170 | 55.2 | -12 |

| f (MHz) | Z_{source} (Ω) | Z_{in} (Ω) | Max Output Power | | | | | |
|------------|-------------------------------------|---------------------------------|---|-----------|-------|-----|-----------------|-----------------------|
| | | | P3dB | | | | | |
| | | | $Z_{\text{load}}^{(2)}$ (Ω) | Gain (dB) | (dBm) | (W) | η_D (%) | AM/PM ($^\circ$) |
| 1930 | $1.28 - j3.84$ | $1.43 + j4.30$ | $1.70 - j3.10$ | 18.1 | 53.3 | 212 | 60.1 | -16 |
| 1960 | $1.53 - j4.20$ | $1.80 + j4.66$ | $1.70 - j3.17$ | 18.2 | 53.4 | 217 | 61.6 | -17 |
| 1995 | $2.15 - j4.41$ | $2.53 + j5.08$ | $1.66 - j3.36$ | 18.3 | 53.2 | 211 | 59.4 | -17 |

(1) Load impedance for optimum P1dB power.

(2) Load impedance for optimum P3dB power.

 Z_{source} = Measured impedance presented to the input of the device at the package reference plane.

 Z_{in} = Impedance as measured from gate contact to ground.

 Z_{load} = Measured impedance presented to the output of the device at the package reference plane.

Table 11. Load Pull Performance — Maximum Drain Efficiency Tuning
 $V_{DD} = 28 \text{ Vdc}$, $I_{DQ} = 1044 \text{ mA}$, Pulsed CW, $10 \mu\text{sec}(\text{on})$, 10% Duty Cycle

| f (MHz) | Z_{source} (Ω) | Z_{in} (Ω) | Max Drain Efficiency | | | | | |
|------------|-------------------------------------|---------------------------------|---|-----------|-------|-----|-----------------|-----------------------|
| | | | P1dB | | | | | |
| | | | $Z_{\text{load}}^{(1)}$ (Ω) | Gain (dB) | (dBm) | (W) | η_D (%) | AM/PM ($^\circ$) |
| 1930 | $1.28 - j3.84$ | $1.51 + j4.28$ | $1.85 - j1.07$ | 23.4 | 50.1 | 103 | 68.4 | -15 |
| 1960 | $1.53 - j4.20$ | $1.91 + j4.57$ | $1.81 - j1.49$ | 23.1 | 50.7 | 118 | 70.3 | -16 |
| 1995 | $2.15 - j4.41$ | $2.69 + j4.90$ | $1.75 - j1.77$ | 23.1 | 50.6 | 114 | 66.1 | -16 |

| f (MHz) | Z_{source} (Ω) | Z_{in} (Ω) | Max Drain Efficiency | | | | | |
|------------|-------------------------------------|---------------------------------|---|-----------|-------|-----|-----------------|-----------------------|
| | | | P3dB | | | | | |
| | | | $Z_{\text{load}}^{(2)}$ (Ω) | Gain (dB) | (dBm) | (W) | η_D (%) | AM/PM ($^\circ$) |
| 1930 | $1.28 - j3.84$ | $1.55 + j4.38$ | $2.26 - j1.34$ | 20.9 | 51.5 | 142 | 71.9 | -21 |
| 1960 | $1.53 - j4.20$ | $2.03 + j4.74$ | $2.05 - j1.25$ | 21.3 | 51.2 | 130 | 73.0 | -24 |
| 1995 | $2.15 - j4.41$ | $2.78 + j5.10$ | $1.96 - j1.87$ | 20.9 | 51.6 | 145 | 69.3 | -23 |

(1) Load impedance for optimum P1dB efficiency.

(2) Load impedance for optimum P3dB efficiency.

 Z_{source} = Measured impedance presented to the input of the device at the package reference plane.

 Z_{in} = Impedance as measured from gate contact to ground.

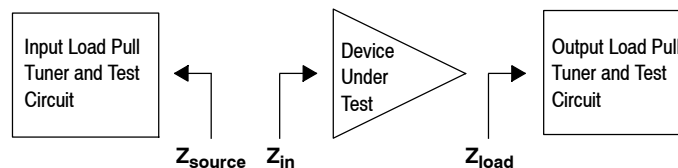
 Z_{load} = Measured impedance presented to the output of the device at the package reference plane.

P1dB – TYPICAL LOAD PULL CONTOURS — 1960 MHz

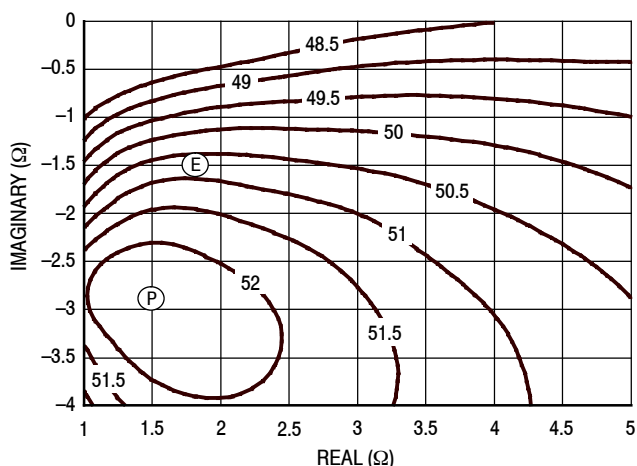

Figure 20. P1dB Load Pull Output Power Contours (dBm)

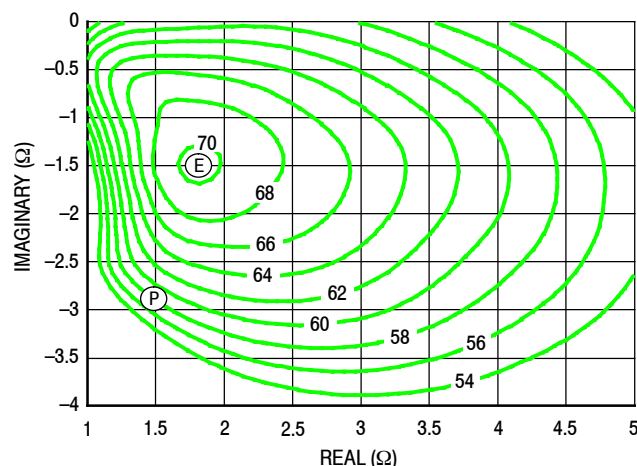

Figure 21. P1dB Load Pull Efficiency Contours (%)

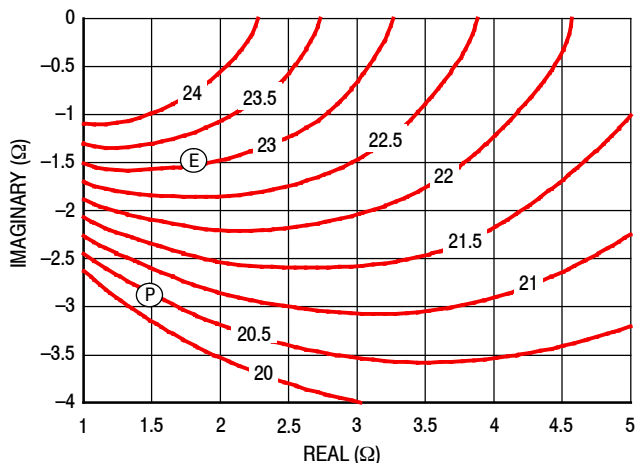

Figure 22. P1dB Load Pull Gain Contours (dB)

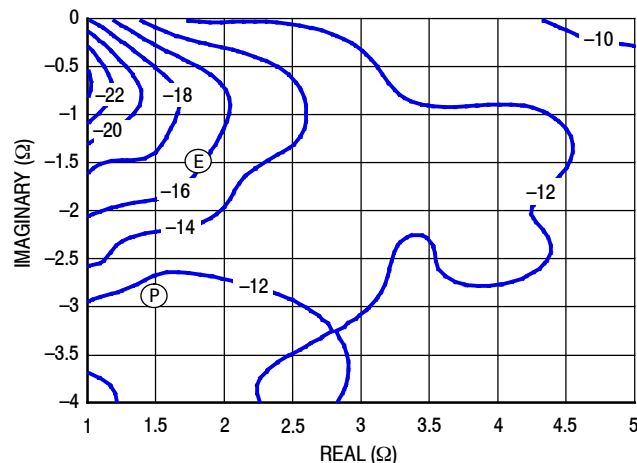

Figure 23. P1dB Load Pull AM/PM Contours (°)

NOTE: (P) = Maximum Output Power
(E) = Maximum Drain Efficiency

- Gain
- Drain Efficiency
- Linearity
- Output Power

P3dB - TYPICAL LOAD PULL CONTOURS — 1960 MHz

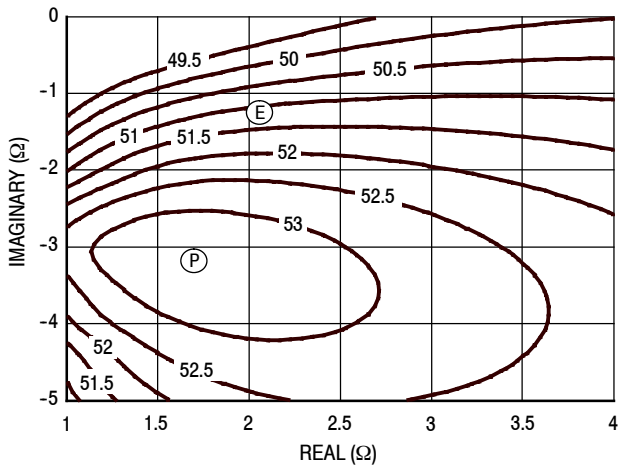

Figure 24. P3dB Load Pull Output Power Contours (dBm)

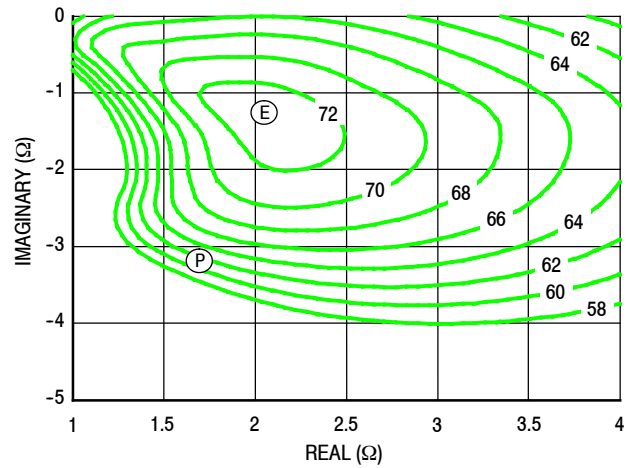

Figure 25. P3dB Load Pull Efficiency Contours (%)

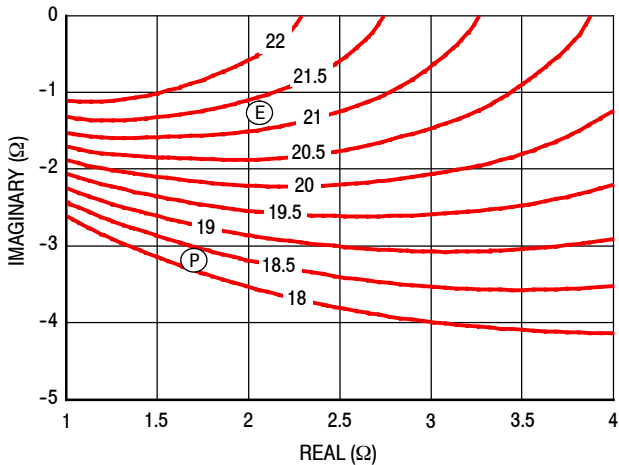

Figure 26. P3dB Load Pull Gain Contours (dB)

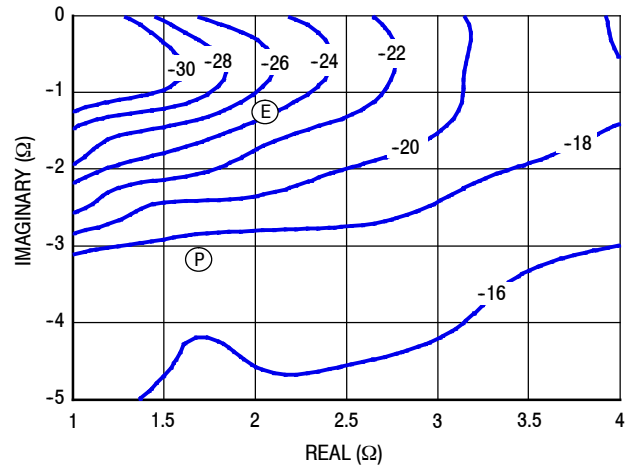

Figure 27. P3dB Load Pull AM/PM Contours (°)

NOTE: (P) = Maximum Output Power
 (E) = Maximum Drain Efficiency

- Gain
- Drain Efficiency
- Linearity
- Output Power

P3dB - TYPICAL CARRIER LOAD PULL CONTOURS — 1960 MHz

PACKAGE DIMENSIONS

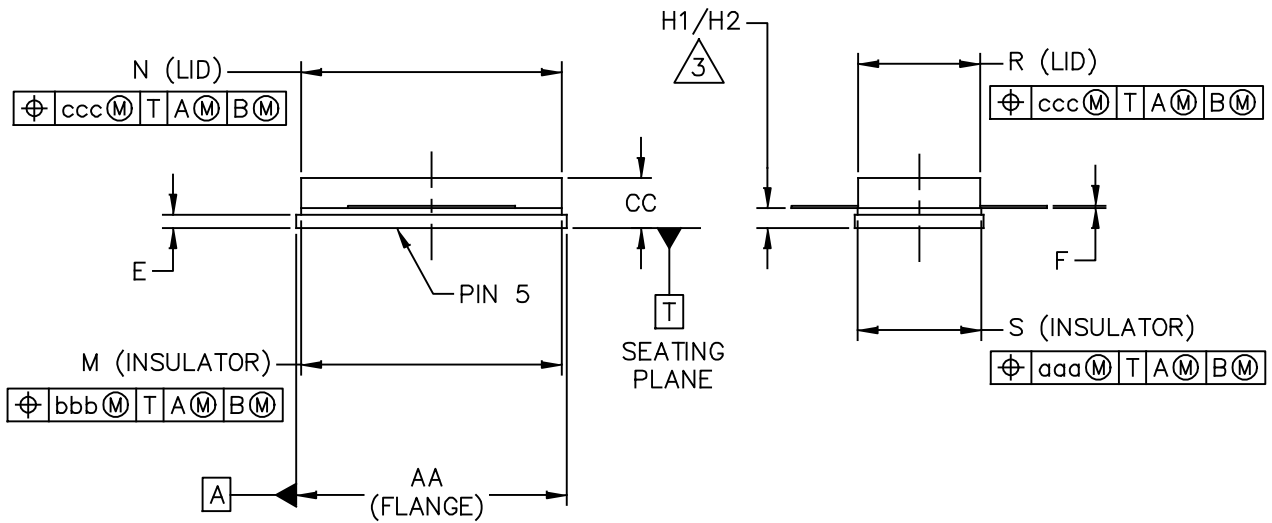
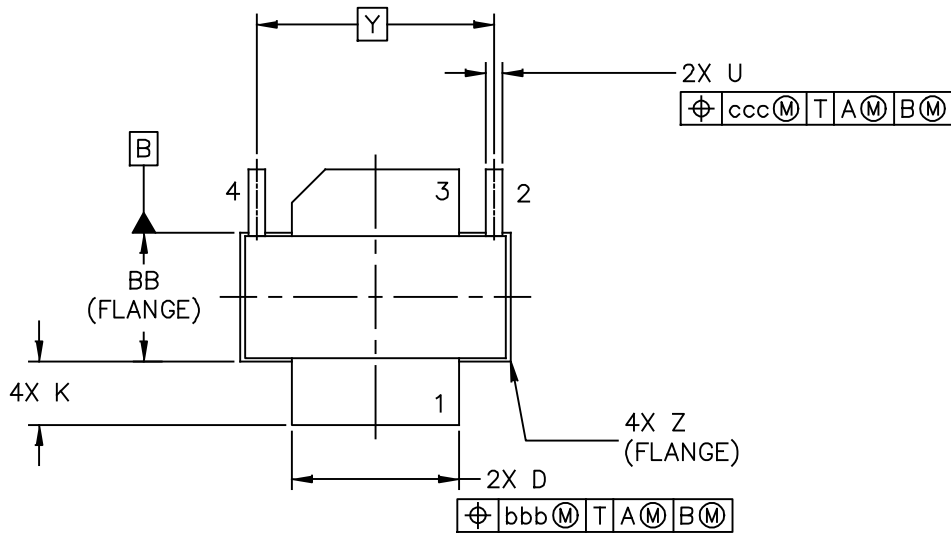

| | | |
|---|--------------------------|----------------------------|
| © FREESCALE SEMICONDUCTOR, INC. ALL RIGHTS RESERVED. | MECHANICAL OUTLINE | PRINT VERSION NOT TO SCALE |
| TITLE: NI-780S-2L2LA | DOCUMENT NO: 98ASA00658D | REV: 0 |
| | STANDARD: NON-JEDEC | |
| | 05 DEC 2014 | |

NOTES:

1. CONTROLLING DIMENSION: INCH.
2. INTERPRET DIMENSIONS AND TOLERANCES PER ASME Y14.5M-1994.

3. DIMENSIONS H1 AND H2 ARE MEASURED .030 INCH (0.762 MM) AWAY FROM THE FLANGE TO CLEAR THE EPOXY FLOW OUT REGION PARALLEL TO DATUM B. H1 APPLIES TO PINS 1 & 3. H2 APPLIES TO PINS 2 & 4.

| DIM | INCH | | MILLIMETER | | DIM | INCH | | MILLIMETER | |
|---|------|------|--------------------|-------|--------------------------------------|----------------------------|-------|------------|-------|
| | MIN | MAX | MIN | MAX | | MIN | MAX | MIN | MAX |
| AA | .805 | .815 | 20.45 | 20.70 | R | .365 | .375 | 9.27 | 9.53 |
| BB | .380 | .390 | 9.65 | 9.91 | S | .365 | .375 | 9.27 | 9.53 |
| CC | .125 | .170 | 3.18 | 4.32 | U | .045 | .055 | 1.14 | 1.40 |
| D | .495 | .505 | 12.57 | 12.83 | Y | .710 BSC | | 18.03 BSC | |
| E | .035 | .045 | 0.89 | 1.14 | Z | R.000 | R.040 | R0.00 | R1.02 |
| F | .003 | .007 | 0.08 | 0.18 | aaa | .005 | | 0.13 | |
| H1 | .057 | .067 | 1.45 | 1.70 | bbb | .010 | | 0.25 | |
| H2 | .054 | .070 | 1.37 | 1.78 | ccc | .015 | | 0.38 | |
| K | .170 | .210 | 4.32 | 5.33 | | | | | |
| M | .774 | .786 | 19.66 | 19.96 | | | | | |
| N | .772 | .788 | 19.61 | 20.02 | | | | | |
| © FREESCALE SEMICONDUCTOR, INC. ALL RIGHTS RESERVED. | | | MECHANICAL OUTLINE | | | PRINT VERSION NOT TO SCALE | | | |
| TITLE: NI-780S-2L2LA | | | | | DOCUMENT NO: 98ASA00658D REV: 0 | | | | |
| | | | | | STANDARD: NON-JEDEC | | | | |
| | | | | | 05 DEC 2014 | | | | |

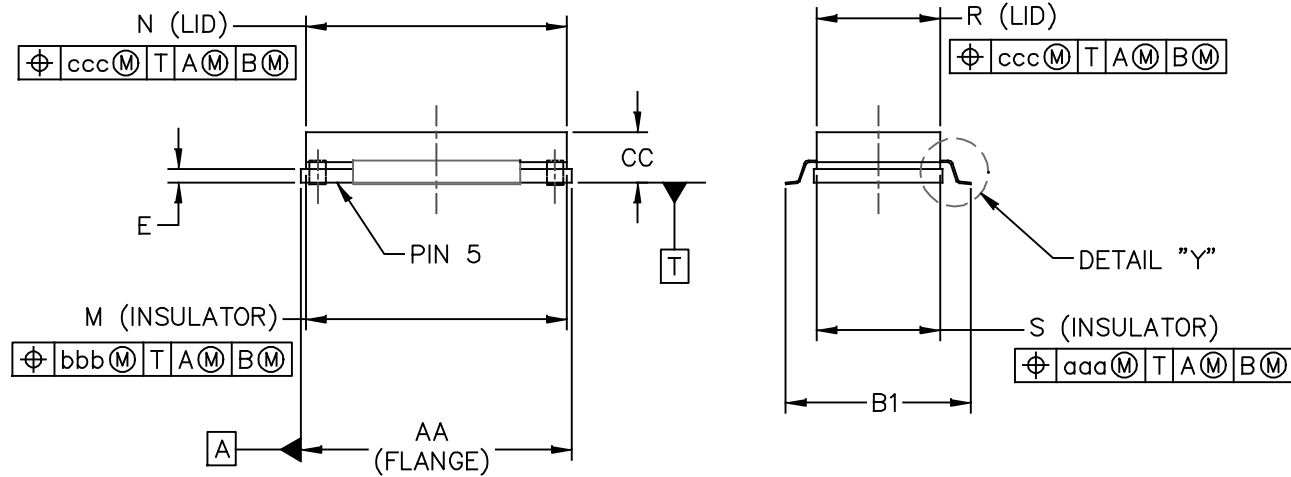
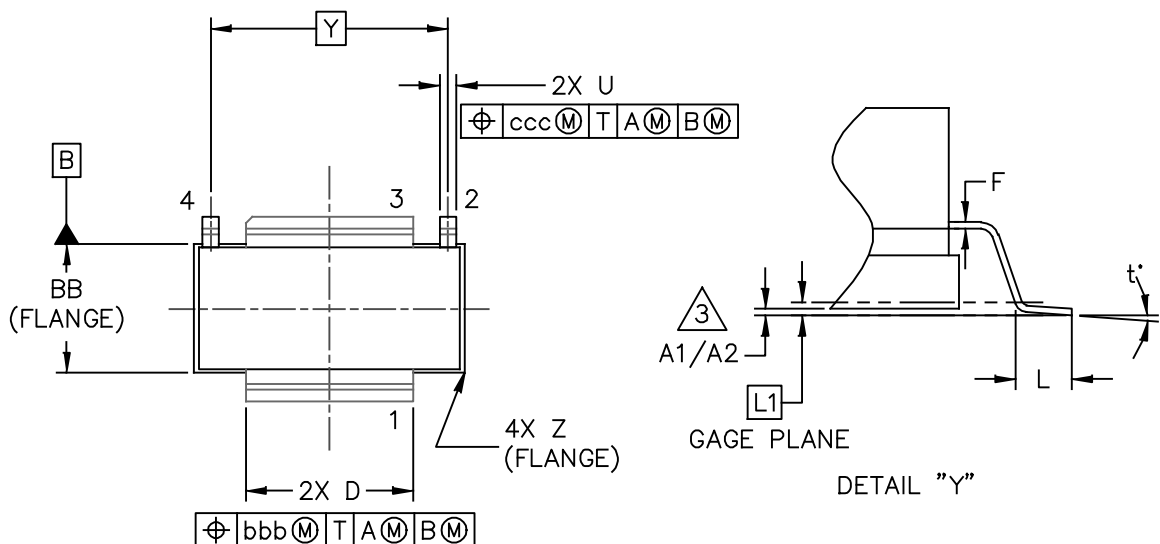

| | | | | | |
|---|--|--------------------|--------------------------|----------------------------|-------------|
| © FREESCALE SEMICONDUCTOR, INC. ALL RIGHTS RESERVED. | | MECHANICAL OUTLINE | | PRINT VERSION NOT TO SCALE | |
| TITLE: NI-780GS-2L2LA | | | DOCUMENT NO: 98ASA00624D | | REV: 0 |
| | | | STANDARD: NON-JEDEC | | |
| | | | | | 05 DEC 2014 |

NOTES:

1. CONTROLLING DIMENSION: INCH.
2. INTERPRET DIMENSIONS AND TOLERANCES PER ASME Y14.5M-1994.

3. DIMENSION A1/A2 IS MEASURED WITH REFERENCE TO DATUM T. THE POSITIVE VALUE IMPLIES THAT THE PACKAGE BOTTOM IS HIGHER THAN THE LEAD BOTTOM. A1 APPLIES TO PINS 1 AND 3. A2 APPLIES TO PINS 2 AND 4.

| DIM | INCH | | MILLIMETER | | DIM | INCH | | MILLIMETER | |
|---|----------|------|--------------------|-------|--------------------------|----------------------------|--------|------------|-------|
| | MIN | MAX | MIN | MAX | | MIN | MAX | MIN | MAX |
| AA | .805 | .815 | 20.45 | 20.70 | R | .365 | .375 | 9.27 | 9.53 |
| A1 | .002 | .008 | 0.05 | 0.20 | S | .365 | .375 | 9.27 | 9.53 |
| A2 | .002 | .008 | 0.05 | 0.20 | U | .045 | .055 | 1.14 | 1.40 |
| BB | .380 | .390 | 9.65 | 9.91 | Y | .710 BSC | | 18.03 BSC | |
| B1 | .546 | .562 | 13.87 | 14.27 | Z | R.000 | R.040 | R0.00 | R1.02 |
| CC | .125 | .170 | 3.18 | 4.32 | t' | 0' | 8' | 0' | 8' |
| D | .495 | .505 | 12.57 | 12.83 | aaa | .005 | | 0.13 | |
| E | .035 | .045 | 0.89 | 1.14 | bbb | .010 | | 0.25 | |
| F | .003 | .007 | 0.08 | 0.18 | ccc | .015 | | 0.38 | |
| L | .038 | .046 | 0.97 | 1.17 | | | | | |
| L1 | .010 BSC | | 0.25 BSC | | | | | | |
| M | .774 | .786 | 19.66 | 19.96 | | | | | |
| N | .772 | .788 | 19.61 | 20.02 | | | | | |
| © FREESCALE SEMICONDUCTOR, INC. ALL RIGHTS RESERVED. | | | MECHANICAL OUTLINE | | | PRINT VERSION NOT TO SCALE | | | |
| TITLE: NI-780GS-2L2LA | | | | | DOCUMENT NO: 98ASA00624D | | REV: 0 | | |
| | | | | | STANDARD: NON-JEDEC | | | | |
| | | | | | 05 DEC 2014 | | | | |

Refer to the following resources to aid your design process.

Application Notes

- AN1955: Thermal Measurement Methodology of RF Power Amplifiers

Engineering Bulletins

- EB212: Using Data Sheet Impedances for RF LDMOS Devices

Software

- Electromigration MTTF Calculator
- RF High Power Model
- s2p File

Development Tools

- Printed Circuit Boards

To Download Resources Specific to a Given Part Number:

1. Go to <http://www.freescale.com/rf>
2. Search by part number
3. Click part number link
4. Choose the desired resource from the drop down menu

REVISION HISTORY

The following table summarizes revisions to this document.

| Revision | Date | Description |
|----------|----------|---------------------------------|
| 0 | May 2015 | • Initial Release of Data Sheet |

How to Reach Us:

Home Page:
freescale.com

Web Support:
freescale.com/support

Information in this document is provided solely to enable system and software implementers to use Freescale products. There are no express or implied copyright licenses granted hereunder to design or fabricate any integrated circuits based on the information in this document.

Freescale reserves the right to make changes without further notice to any products herein. Freescale makes no warranty, representation, or guarantee regarding the suitability of its products for any particular purpose, nor does Freescale assume any liability arising out of the application or use of any product or circuit, and specifically disclaims any and all liability, including without limitation consequential or incidental damages. "Typical" parameters that may be provided in Freescale data sheets and/or specifications can and do vary in different applications, and actual performance may vary over time. All operating parameters, including "typicals," must be validated for each customer application by customer's technical experts. Freescale does not convey any license under its patent rights nor the rights of others. Freescale sells products pursuant to standard terms and conditions of sale, which can be found at the following address: freescale.com/SalesTermsandConditions.

Freescale and the Freescale logo are trademarks of Freescale Semiconductor, Inc., Reg. U.S. Pat. & Tm. Off. Airfast is a trademark of Freescale Semiconductor, Inc. All other product or service names are the property of their respective owners.

© 2015 Freescale Semiconductor, Inc.

Компания «Океан Электроники» предлагает заключение долгосрочных отношений при поставках импортных электронных компонентов на взаимовыгодных условиях!

Наши преимущества:

- Поставка оригинальных импортных электронных компонентов напрямую с производств Америки, Европы и Азии, а так же с крупнейших складов мира;
- Широкая линейка поставок активных и пассивных импортных электронных компонентов (более 30 млн. наименований);
- Поставка сложных, дефицитных, либо снятых с производства позиций;
- Оперативные сроки поставки под заказ (от 5 рабочих дней);
- Экспресс доставка в любую точку России;
- Помощь Конструкторского Отдела и консультации квалифицированных инженеров;
- Техническая поддержка проекта, помощь в подборе аналогов, поставка прототипов;
- Поставка электронных компонентов под контролем ВП;
- Система менеджмента качества сертифицирована по Международному стандарту ISO 9001;
- При необходимости вся продукция военного и аэрокосмического назначения проходит испытания и сертификацию в лаборатории (по согласованию с заказчиком);
- Поставка специализированных компонентов военного и аэрокосмического уровня качества (Xilinx, Altera, Analog Devices, Intersil, Interpoint, Microsemi, Actel, Aeroflex, Peregrine, VPT, Syfer, Eurofarad, Texas Instruments, MS Kennedy, Miteq, Cobham, E2V, MA-COM, Hittite, Mini-Circuits, General Dynamics и др.);

Компания «Океан Электроники» является официальным дистрибьютором и эксклюзивным представителем в России одного из крупнейших производителей разъемов военного и аэрокосмического назначения «JONHON», а так же официальным дистрибьютором и эксклюзивным представителем в России производителя высокотехнологичных и надежных решений для передачи СВЧ сигналов «FORSTAR».



JONHON

«JONHON» (основан в 1970 г.)

Разъемы специального, военного и аэрокосмического назначения:

(Применяются в военной, авиационной, аэрокосмической, морской, железнодорожной, горно- и нефтедобывающей отраслях промышленности)

«FORSTAR» (основан в 1998 г.)

ВЧ соединители, коаксиальные кабели, кабельные сборки и микроволновые компоненты:

(Применяются в телекоммуникациях гражданского и специального назначения, в средствах связи, РЛС, а так же военной, авиационной и аэрокосмической отраслях промышленности).



Телефон: 8 (812) 309-75-97 (многоканальный)

Факс: 8 (812) 320-03-32

Электронная почта: ocean@oceanchips.ru

Web: <http://oceanchips.ru/>

Адрес: 198099, г. Санкт-Петербург, ул. Калинина, д. 2, корп. 4, лит. А