

Precision, Micropower, Single Supply Instrumentation Amplifier (Fixed Gain = 10 or 100)

FEATURES

- Gain Error: 0.04% Max
- Gain Nonlinearity: 0.0008% (8ppm) Max
- Gain Drift: 4ppm/°C Max
- Supply Current: 105µA Max
- Offset Voltage: 160µV Max
- Offset Voltage Drift: 0.4µV/°C Typ
- Offset Current: 600pA Max
- CMRR, G = 100: 100dB Min
- 0.1Hz to 10Hz Noise: 0.9µVp-p Typ
2.3pAp-p Typ
- Gain Bandwidth Product: 250kHz Min
- Single or Dual Supply Operation
- Surface Mount Package Available

APPLICATIONS

- Differential Signal Amplification in Presence of Common Mode Voltage
- Micropower Bridge Transducer Amplifier
 - Thermocouples
 - Strain Gauges
 - Thermistors
- Differential Voltage-to-Current Converter
- Transformer Coupled Amplifier
- 4mA to 20mA Bridge Transmitter

LT, LTC and LT are registered trademarks of Linear Technology Corporation.

DESCRIPTION

The LT[®]1101 establishes the following milestones: (1) It is the first micropower instrumentation amplifier, (2) It is the first single supply instrumentation amplifier, (3) It is the first instrumentation amplifier to feature fixed gains of 10 and/or 100 in low cost, space-saving 8-lead packages.

The LT1101 is completely self-contained: no external gain setting resistor is required. The LT1101 combines its micropower operation (75µA supply current) with a gain error of 0.008%, gain linearity of 3ppm, gain drift of 1ppm/°C. The output is guaranteed to drive a 2k load to ±10V with excellent gain accuracy.

Other precision specifications are also outstanding: 50µV input offset voltage, 130pA input offset current, and low drift (0.4µV/°C and 0.7pA/°C). In addition, unlike other instrumentation amplifiers, there is no output offset voltage contribution to total error.

A full set of specifications are provided with ±15V dual supplies and for single 5V supply operation. The LT1101 can be operated from a single lithium cell or two Ni-Cad batteries. Battery voltage can drop as low as 1.8V, yet the LT1101 still maintains its gain accuracy. In single supply applications, both input and output voltages swing to within a few millivolts of ground. The output sinks current while swinging to ground—no external, power consuming pull down resistors are needed.

TYPICAL APPLICATION



LT1101 • TA01

Gain Error Distribution

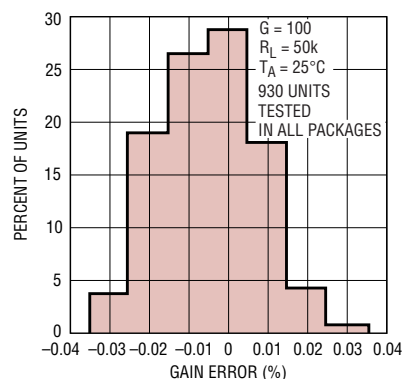

LT1101 • TA02

1101fa

LT1101

ABSOLUTE MAXIMUM RATINGS (Note 1)

Supply Voltage	$\pm 22V$	Operating Temperature Range	
Differential Input Voltage	$\pm 36V$	LT1101AM/LT1101M (OBSOLETE) ...	$-55^{\circ}C$ to $125^{\circ}C$
Input Voltage	Equal to Positive Supply Voltage	LT1101AI/LT1101I	$-40^{\circ}C$ to $85^{\circ}C$
 10V Below Negative Supply Voltage	LT1101AC/LT1101C	$0^{\circ}C$ to $70^{\circ}C$
Output Short Circuit Duration	Indefinite	Storage Temperature Range	$-65^{\circ}C$ to $150^{\circ}C$
		Lead Temperature (Soldering, 10 sec)	$300^{\circ}C$

PACKAGE/ORDER INFORMATION

<p>TOP VIEW</p> <p>H PACKAGE 8-LEAD TO-5 METAL CAN</p> <p>$T_{JMAX} = 150^{\circ}C$, $\theta_{JA} = 150^{\circ}C/W$, $\theta_{JC} = 45^{\circ}C/W$</p>	<p>TOP VIEW</p> <p>N PACKAGE 8-LEAD PDIP</p> <p>$T_{JMAX} = 150^{\circ}C$, $\theta_{JA} = 130^{\circ}C/W$</p> <p>J PACKAGE 8-LEAD CERDIP</p> <p>$T_{JMAX} = 150^{\circ}C$, $\theta_{JA} = 100^{\circ}C/W$</p>	<p>TOP VIEW</p> <p>SW PACKAGE 16-LEAD PLASTIC SO</p> <p>$T_{JMAX} = 150^{\circ}C$, $\theta_{JA} = 100^{\circ}C/W$</p>	
ORDER PART NUMBER	ORDER PART NUMBER		ORDER PART NUMBER
LT1101AMH LT1101MH LT1101ACH LT1101CH	LT1101AMJ8 LT1101MJ8 LT1101ACJ8 LT1101CJ8	LT1101AIN8 LT1101IN8 LT1101ACN8 LT1101CN8	LT1101SW LT1101ISW
OBSOLETE PACKAGES Consider the N8 as an Alternate Source			

Consult LTC Marketing for parts specified with wider operating temperature ranges.

ELECTRICAL CHARACTERISTICS

$V_S = 5V$, $0V$, $V_{CM} = 0.1V$, $V_{REF(PIN 1)} = 0.1V$, $G = 10$ or 100 , $T_A = 25^{\circ}C$, unless otherwise noted. (Note 4)

SYMBOL	PARAMETER	CONDITIONS	LT1101AM/AI/AC			LT1101M/I/C			UNITS
			MIN	TYP	MAX	MIN	TYP	MAX	
G_E	Gain Error	$G = 100$, $V_0 = 0.1V$ to $3.5V$, $R_L = 50k$		0.010	0.050		0.011	0.075	%
		$G = 10$, $V_0 = 0.1V$ to $3.5V$, $R_L = 50k$		0009	0.040		0.010	0.060	%
G_{NL}	Gain Nonlinearity	$G = 100$, $R_L = 50k$		20	60		20	75	ppm
		$G = 10$, $R_L = 50k$ (Note 2)		3	7		3	8	ppm
V_{OS}	Input Offset Voltage			50	160		60	220	μV
		LT1101SW					250	600	μV
I_{OS}	Input Offset Current			0.13	0.60		0.15	0.90	nA
I_B	Input Bias Current			6	8		6	10	nA
I_S	Supply Current			75	105		78	120	μA

1101fa

ELECTRICAL CHARACTERISTICS $V_S = 5V, 0V, V_{CM} = 0.1V, V_{REF(PIN 1)} = 0.1V, G = 10 \text{ or } 100, T_A = 25^\circ C$, unless otherwise noted. (Note 4)

SYMBOL	PARAMETER	CONDITIONS	LT1101AM/AI/AC			LT1101M/I/C			UNITS
			MIN	TYP	MAX	MIN	TYP	MAX	
CMRR	Common Mode Rejection Ratio	1k Source Imbalance	95	106		92	105		dB
		$G = 100, V_{CM} = 0.07V \text{ to } 3.4V$ $G = 10, V_{CM} = 0.07V \text{ to } 3.1V$	84	100		82	99		dB
	Minimum Supply Voltage	(Note 5)		1.8	2.3		1.8	2.3	V
V_O	Maximum Output Voltage Swing	Output High, 50k to GND	4.1	4.3		4.1	4.3		V
		Output High, 2k to GND	3.5	3.9		3.5	3.9		V
		Output Low, $V_{REF} = 0$, No Load		3.3	6		3.3	6	mV
		Output Low, $V_{REF} = 0$, 2k to GND		0.5	1		0.5	1	mV
		Output Low, $V_{REF} = 0, I_{SINK} = 100\mu A$		90	130		90	130	mV
BW	Bandwidth	$G = 100$ (Note 2)	2.0	3.0		2.0	3.0		kHz
		$G = 10$ (Note 2)	22	33		22	33		kHz
SR	Slew Rate	(Note 2)	0.04	0.07		0.04	0.07		V/ μs

$V_S = \pm 15V, V_{CM} = 0V, T_A = 25^\circ C$, Gain = 10 or 100, unless otherwise noted.

SYMBOL	PARAMETER	CONDITIONS	LT1101AM/AI/AC			LT1101M/I/C			UNITS
			MIN	TYP	MAX	MIN	TYP	MAX	
G_E	Gain Error	$G = 100, V_O = \pm 10V, R_L = 50k$		0.008	0.040		0.009	0.060	%
		$G = 100, V_O = \pm 10V, R_L = 2k$		0.011	0.055		0.012	0.070	%
		$G = 100, V_O = \pm 10V, R_L = 50k \text{ or } 2k$		0.008	0.040		0.009	0.060	%
G_{NL}	Gain Nonlinearity	$G = 100, R_L = 50k$		7	16		8	20	ppm
		$G = 100, R_L = 2k$		24	45		25	60	ppm
		$G = 10, R_L = 50k \text{ or } 2k$		3	8		3	9	ppm
V_{OS}	Input Offset Voltage	LT1101SW		50	160		60	220	μV
							250	600	μV
I_{OS}	Input Offset Current			0.13	0.60		0.15	0.90	nA
I_B	Input Bias Current			6	8		6	10	nA
		Input Resistance Common Mode Differential Mode	(Note 2) (Note 2)	4 7	7 12		3 5	7 12	$G\Omega$ $G\Omega$
e_n	Input Noise Voltage	0.1Hz to 10Hz (Note 3)		0.9	1.8		0.9		μV_{p-p}
		Input Noise Voltage Density	$f_0 = 10Hz$ (Note 3) $f_0 = 1000Hz$ (Note 3)		45 43	64 54		45 43	
i_n	Input Noise Current	0.1Hz to 10Hz (Note 3)		2.3	4.0		2.3		pA_{p-p}
		Input Noise Current Density	$f_0 = 10Hz$ (Note 3) $f_0 = 1000Hz$		0.06 0.02	0.10		0.06 0.02	
	Input Voltage Range	$G = 100$	13.0	13.8		13.0	13.8		V
			-14.4	-14.7		-14.4	-14.7		V
		$G = 10$	11.5	12.5		11.5	12.5		V
			-13.0	-13.3		-13.0	-13.3		V
CMRR	Common Mode Rejection Ratio	1k Source Imbalance	100	112		98	112		dB
		$G = 100$, Over CM Range $G = 10$, Over CM Range	84	100		82	99		dB
PSRR	Power Supply Rejection Ratio	$V_S = +2.2V, -0.1V \text{ to } \pm 18V$	102	114		100	114		dB
I_S	Supply Current			92	130		94	150	μA

ELECTRICAL CHARACTERISTICS $V_S = \pm 15V$, $V_{CM} = 0V$, $T_A = 25^\circ C$, Gain = 10 or 100, unless otherwise noted.

SYMBOL	PARAMETER	CONDITIONS	LT1101AM/AI			LT1101M/I			UNITS
			MIN	TYP	MAX	MIN	TYP	MAX	
V_O	Maximum Output Voltage Swing	$R_L = 50k$ $R_L = 2k$	13.0 11.0	14.2 13.2		13.0 11.0	14.2 13.2		V V
BW	Bandwidth	G = 100 (Note 2) G = 10 (Note 2)	2.3 25	3.5 37		2.3 25	3.5 37		kHz kHz
SR	Slew Rate		0.06	0.10		0.06	0.10		V/ μs

ELECTRICAL CHARACTERISTICS $V_S = \pm 15V$, $V_{CM} = 0V$, Gain = 10 or 100, $-55^\circ C \leq T_A \leq 125^\circ C$ for AM/M grades, $-40^\circ C \leq T_A \leq 85^\circ C$ for AI/I grades, unless otherwise noted.

SYMBOL	PARAMETER	CONDITIONS	LT1101AM/AI			LT1101M/I			UNITS
			MIN	TYP	MAX	MIN	TYP	MAX	
G_E	Gain Error	G = 100, $V_O = \pm 10V$, $R_L = 50k$ G = 100, $V_O = \pm 10V$, $R_L = 5k$ G = 10, $V_O = \pm 10V$, $R_L = 50k$ or $5k$		0.024 0.030 0.015	0.070 0.100 0.070		0.026 0.035 0.018	0.100 0.130 0.100	% % %
TCG_E	Gain Error Drift (Note 2)	G = 100, $R_L = 50k$ G = 100, $R_L = 5k$ G = 10, $R_L = 50k$ or $5k$		2 2 1	4 7 4		2 2 1	5 8 5	ppm/ $^\circ C$ ppm/ $^\circ C$ ppm/ $^\circ C$
G_{NL}	Gain Nonlinearity	G = 100, $R_L = 50k$ G = 100, $R_L = 5k$ G = 10, $R_L = 50k$ G = 10, $R_L = 5k$		24 70 4 10	70 300 13 40		26 75 5 12	90 500 15 60	ppm ppm ppm ppm
V_{OS}	Input Offset Voltage	LT1101ISW		90	350		110 110	500 950	μV μV
$\Delta V_{OS}/\Delta T$	Input Offset Voltage Drift	(Note 2) LT1101ISW		0.4	2.0		0.5 0.5	2.8 4.8	$\mu V/^\circ C$ mV/ $^\circ C$
I_{OS}	Input Offset Current			0.16	0.80		0.19	1.30	nA
$\Delta I_{OS}/\Delta T$	Input Offset Current Drift	(Note 2)		0.5	4.0		0.8	7.0	pA/ $^\circ C$
I_B	Input Bias Current			7	10		7	12	nA
$\Delta I_B/\Delta T$	Input Bias Current Drift	(Note 2)		10	25		10	30	pA/ $^\circ C$
CMRR	Common Mode Rejection Ratio	G = 100, $V_{CM} = -14.4V$ to $13V$ G = 100, $V_{CM} = -13V$ to $11.5V$	96 80	111 99		94 78	111 98		dB dB
PSRR	Power Supply Rejection Ratio	$V_S = 3.0$, $-0.1V$ to $\pm 18V$	98	110		94	110		dB
I_S	Supply Current			105	165		108	190	μA
V_O	Maximum Output Voltage Swing	$R_L = 50k$ $R_L = 5k$	12.5 11.0	14.0 13.5		12.5 11.0	14.0 13.5		V V

ELECTRICAL CHARACTERISTICS $V_S = \pm 15V$, $V_{CM} = 0V$, Gain = 10 or 100, $0^\circ C \leq T_A \leq 70^\circ C$, unless otherwise noted.

SYMBOL	PARAMETER	CONDITIONS	LT1101AC			LT1101C/S			UNITS
			MIN	TYP	MAX	MIN	TYP	MAX	
G _E	Gain Error	G = 100, V _O = ±10V, R _L = 50k		0.012	0.055		0.014	0.080	%
		G = 100, V _O = ±10V, R _L = 2k		0.018	0.085		0.020	0.100	%
		G = 10, V _O = ±10V, R _L = 50k or 2k		0.009	0.055		0.010	0.080	%
TCG _E	Gain Error Drift (Note 2)	G = 100, R _L = 50k		1	4		1	5	ppm/°C
		G = 100, R _L = 2k		2	7		2	9	ppm/°C
		G = 10, R _L = 50k or 5k		1	4		1	5	ppm/°C
G _{NL}	Gain Nonlinearity	G = 100, R _L = 50k		9	25		10	35	ppm
		G = 100, R _L = 2k		33	75		36	100	ppm
		G = 10, R _L = 50k or 2k		4	10		4	11	ppm
V _{OS}	Input Offset Voltage			70	250		85	350	μV
		LT1101SW					300	800	μV
ΔV _{OS} /ΔT	Input Offset Voltage Drift	(Note 2)		0.4	2.0		0.5	2.8	μV/°C
		LT1101SW					1.2	4.5	μV/°C
I _{OS}	Input Offset Current			0.14	0.70		0.17	1.10	nA
ΔI _{OS} /ΔT	Input Offset Current Drift	(Note 2)		0.5	4.0		0.8	7.0	pA/°C
I _B	Input Bias Current			6	9		6	11	nA
ΔI _B /ΔT	Input Bias Current Drift	(Note 2)		10	25		10	30	pA/°C
CMRR	Common Mode Rejection Ratio	G = 100, V _{CM} = -14.4V to 13V		98	112		96	112	dB
		G = 100, V _{CM} = -13V to 11.5V		82	100		80	99	dB
PSRR	Power Supply Rejection Ratio	V _S = 2.5, -0.1V to ±18V		100	112		97	112	dB
I _S	Supply Current			98	148		100	170	μA
V _O	Maximum Output Voltage Swing	R _L = 50k		±12.5	±14.1		±12.5	±14.1	V
		R _L = 2k		±10.5	±13.0		±10.5	±13.0	V

ELECTRICAL CHARACTERISTICS

$V_S = 5V, 0V, V_{CM} = 0.1V, V_{REF(PIN\ 1)} = 0.1V, \text{Gain} = 10 \text{ or } 100,$
 $-40^\circ\text{C} \leq T_A \leq 85^\circ\text{C}$ for Al/I grades, unless otherwise noted (Note 4).

SYMBOL	PARAMETER	CONDITIONS	LT1101AM/AI			LT1101M/I			UNITS	
			MIN	TYP	MAX	MIN	TYP	MAX		
G_E	Gain Error	$G = 100, V_0 = 0.1V \text{ to } 3.5V, R_L = 50k$		0.026	0.080		0.028	0.120	%	
		$G = 10, V_{CM} = 0.15, R_L = 50k$		0.011	0.070		0.014	0.100	%	
TCG_E	Gain Error Drift	$R_L = 50k$ (Note 2)		1	4		1	5	ppm/ $^\circ\text{C}$	
G_{NL}	Gain Nonlinearity	$G = 100, R_L = 50k$		45	110		48	140	ppm	
		$G = 10, R_L = 50k$ (Note 2)		4	13		5	15	ppm	
V_{OS}	Input Offset Voltage	LT1101ISW		90	350		110	500	μV	
							110	950	μV	
$\Delta V_{OS}/\Delta T$	Input Offset Voltage Drift	(Note 2) LT1101ISW		0.4	2.0		0.5	2.8	$\mu\text{V}/^\circ\text{C}$	
							0.5	4.8	$\mu\text{V}/^\circ\text{C}$	
I_{OS}	Input Offset Current			0.16	0.80		0.19	1.30	nA	
$\Delta V_{OS}/\Delta T$	Input Offset Current Drift	(Note 2)		0.5	4.0		0.8	7.0	$\text{pA}/^\circ\text{C}$	
I_B	Input Bias Current			7	10		7	12	nA	
$\Delta I_B/\Delta T$	Input Bias Current Drift	(Note 2)		10	25		10	30	$\text{pA}/^\circ\text{C}$	
CMRR	Common Mode Rejection Ratio	$G = 100, V_{CM} = 0.1V \text{ to } 3.2V$	91	105		88	104		dB	
		$G = 10, V_{CM} = 0.1V \text{ to } 2.9V, V_{REF} = 0.15V$	80	98		77	97		dB	
I_S	Supply Current			88	135		92	160	μA	
V_0	Maximum Output Voltage Swing	Output High, 50k to GND	3.8	4.1		3.8	4.1		V	
		Output High, 2k to GND	3.0	3.7		3.0	3.7		V	
		Output Low, $V_{REF} = 0$, No Load		4.5	8		4.5	8		mV
		Output Low, $V_{REF} = 0$, 2k to GND		0.7	1.5		0.7	1.5		mV
		Output Low, $V_{REF} = 0, I_{SINK} = 100\mu\text{A}$		125	170		125	170		mV

ELECTRICAL CHARACTERISTICS $V_S = 5V, 0V, V_{CM} = 0.1V, V_{REF(PIN 1)} = 0.1V, \text{Gain} = 10 \text{ or } 100,$
 $0^\circ\text{C} \leq T_A \leq 70^\circ\text{C},$ unless otherwise noted (Note 4).

SYMBOL	PARAMETER	CONDITIONS	LT1101AC			LT1101C/S			UNITS
			MIN	TYP	MAX	MIN	TYP	MAX	
G _E	Gain Error	G = 100, V _O = 0.1V to 3.5V, R _L = 50k		0.017	0.065		0.018	0.095	%
		G = 10, V _{CM} = 0.15V, R _L = 50k		0.010	0.060		0.012	0.080	%
TCG _E	Gain Error Drift	R _L = 50k (Note 2)		1	4		1	5	ppm/°C
G _{NL}	Gain Nonlinearity	G = 100, R _L = 50k		25	80		25	100	ppm
		G = 10, R _L = 50k (Note 2)		4	10		4	11	ppm
V _{OS}	Input Offset Voltage	LT1101SW		70	250		85	350	μV
							300	800	μV
ΔV _{OS} /ΔT	Input Offset Voltage Drift	(Note 2)		0.4	2.0		0.5	2.8	μV/°C
		LT1101SW					1.2	4.5	μV/°C
I _{OS}	Input Offset Current			0.14	0.70		0.17	1.10	nA
ΔI _{OS} /ΔT	Input Offset Current Drift	(Note 2)		0.5	4.0		0.8	7	pA/°C
I _B	Input Bias Current			6	9		6	11	nA
ΔI _B /ΔT	Input Bias Current Drift	(Note 2)		10	25		10	30	pA/°C
CMRR	Common Mode Rejection Ratio	G = 100, V _{CM} = 0.07V to 3.3V	93	105		90	104		dB
		G = 10, V _{CM} = 0.07V to 3V, V _{REF} = 0.15V	82	99		80	98		dB
I _S	Supply Current			80	120		85	145	μA
V _O	Maximum Output Voltage Swing	Output High, 50k to GND	4.0	4.2		4.0	4.2		V
		Output High, 2k to GND	3.3	3.8		3.3	3.8		V
		Output Low, V _{REF} = 0, No Load		4	7		4	7	mV
		Output Low, V _{REF} = 0, 2k to GND		0.6	1.2		0.6	1.2	mV
		Output Low, V _{REF} = 0, I _{SINK} = 100μA		100	150		100	150	mV

Note 1: Absolute Maximum Ratings are those values beyond which the life of a device may be impaired.

Note 2: This parameter is not tested. It is guaranteed by design and by inference from other tests.

Note 3: This parameter is tested on a sample basis only.

Note 4: These test conditions are equivalent to V_S = 4.9V, -0.1V, V_{CM} = 0V, V_{REF(PIN1)} = 0V.

Note 5: Minimum supply voltage is guaranteed by the power supply rejection test. The LT1101 actually works at 1.8V supply with minimal degradation in performance.

TYPICAL PERFORMANCE CHARACTERISTICS

Gain = 100 Nonlinearity Distribution



Gain = 10 Nonlinearity Distribution



Gain vs Frequency



Gain Error Over Temperature



Gain Nonlinearity Temperature

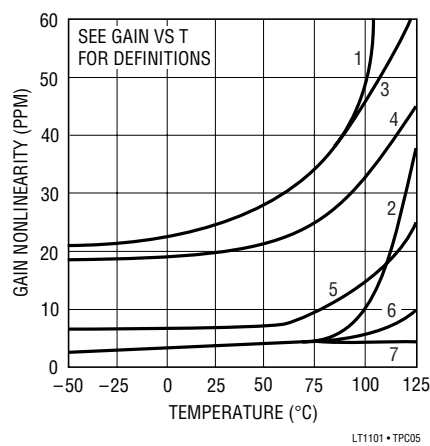

Input Offset Voltage Distribution



Supply Current vs Temperature



Input Bias and Offset Currents vs Temperature

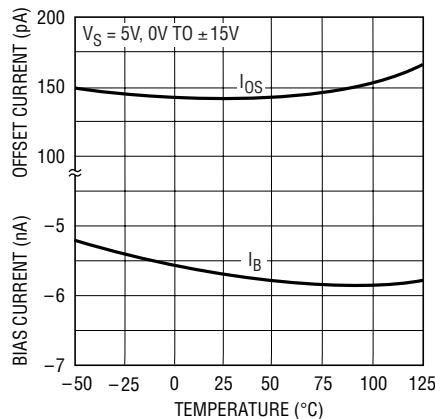

Input Bias Current vs Common Mode Voltage

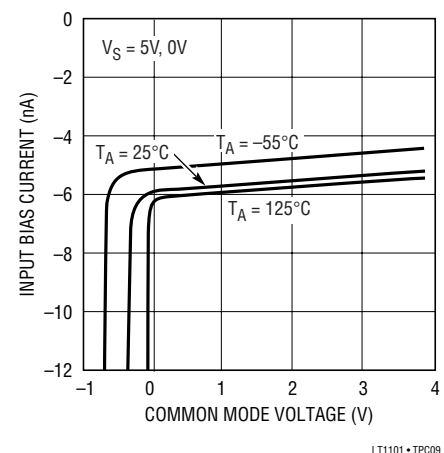

TYPICAL PERFORMANCE CHARACTERISTICS

Common Mode Rejection Ratio vs Frequency

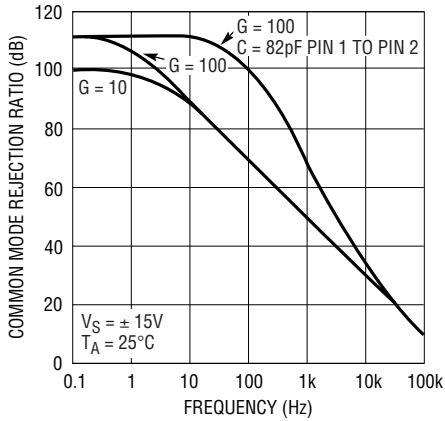

LT1101 • TPC10

Common Mode Range vs Supply Voltage

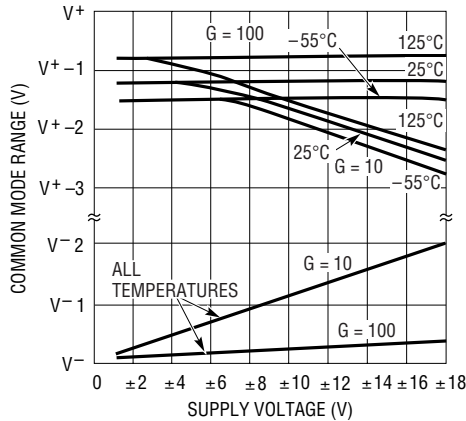

LT1101 • TPC11

Power Supply Rejection Ratio vs Frequency

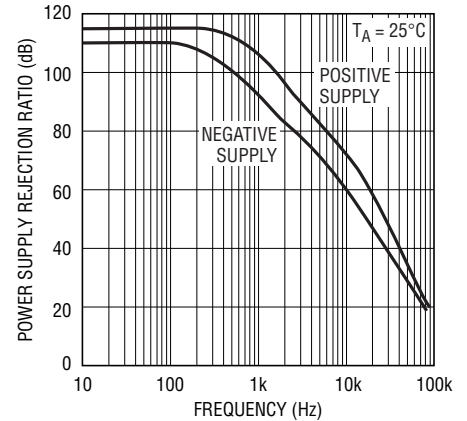

LT1101 • TPC12

Output Saturation vs Temperature vs Sink Current

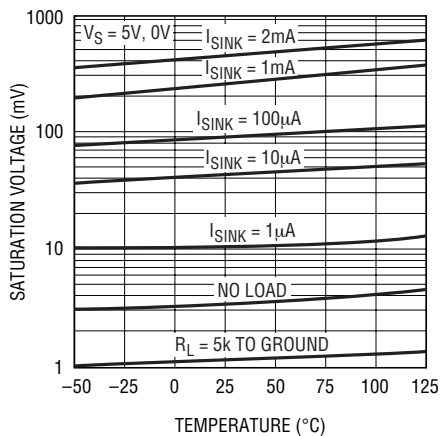

LT1101 • TPC13

Output Voltage Swing vs Load Current

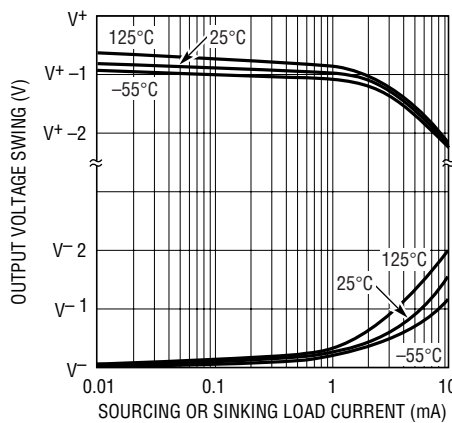

LT1101 • TPC14

Short-Circuit Current vs Time

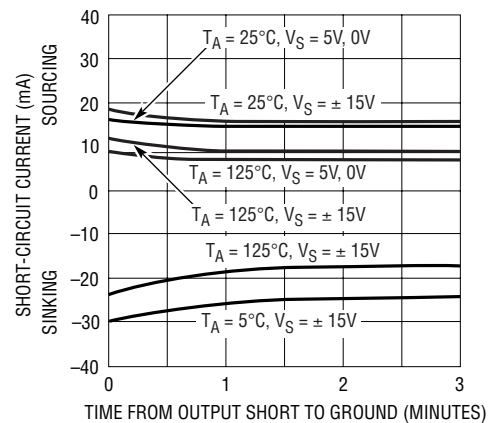

LT1101 • TPC15

Capacitive Load Handling

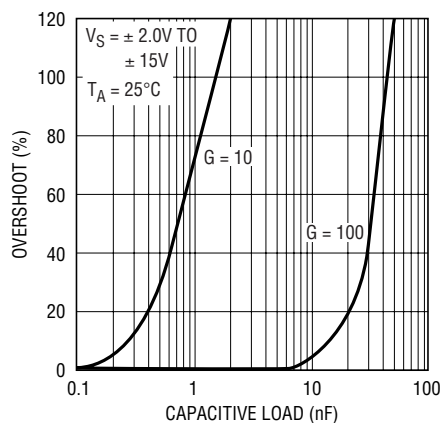

LT1101 • TPC16

Undistorted Output Swing vs Frequency

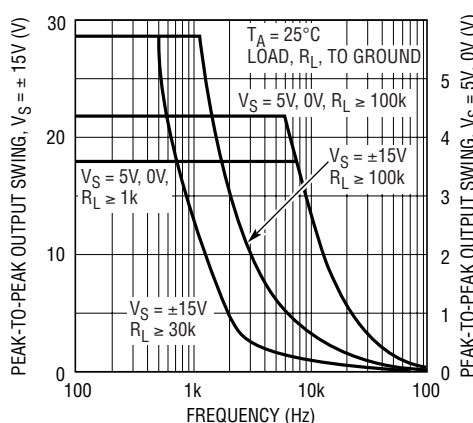

LT1101 • TPC17

Output Impedance vs Frequency

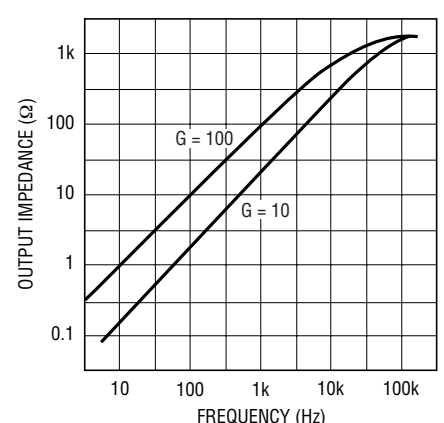

LT1101 • TPC18

TYPICAL PERFORMANCE CHARACTERISTICS

Noise Spectrum

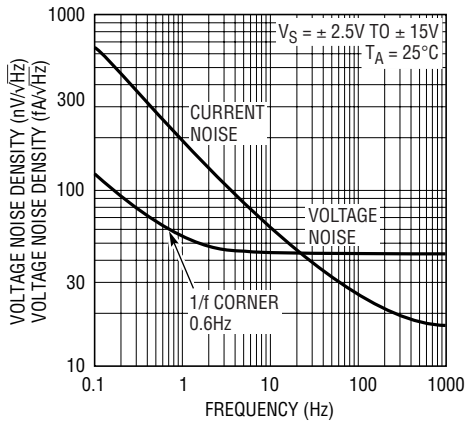

LT1101 • TPC19

Warm-Up Drift

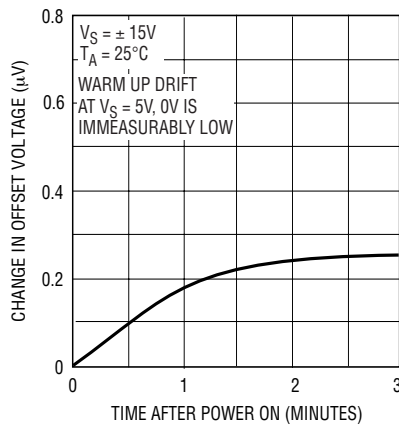

LT1101 • TPC20

Large Signal Transient Response
 $G = 10, V_S = 5V, 0V$



50μs/DIV
OUTPUT FROM 0V TO 4.5V, NO LOAD

LT1101 • TPC20.1

Large Signal Transient Response
 $G = 10, V_S = 15V$

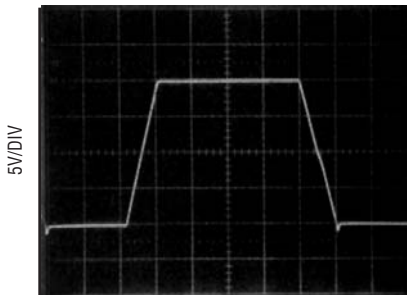

200μs/DIV
NO LOAD

LT1101 • TPC20.2

Large Signal Transient Response
 $G = 100, V_S = \pm 15V$

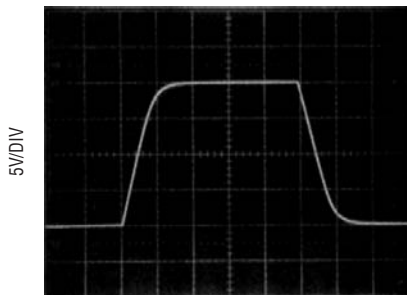

200μs/DIV
NO LOAD

LT1101 • TPC20.3

Large Signal Transient Response
 $G = 100, V_S = 5V, 0V$

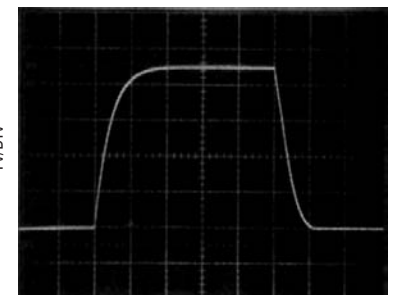

100μs/DIV
OUTPUT FROM 0V TO 4.5V, NO LOAD

LT1101 • TPC20.4

Small Signal Transient Response
 $G = 10, V_S = 5V, 0V$

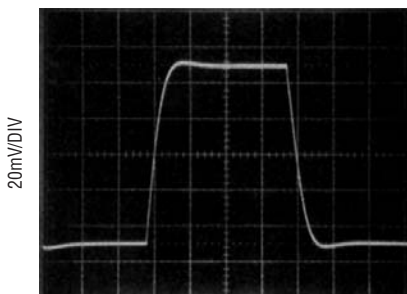

20μs/DIV
OUTPUT FROM 0.05V TO 0.15V, NO LOAD

LT1101 • TPC20.5

Small Signal Transient Response
 $G = 10, V_S = \pm 15V$

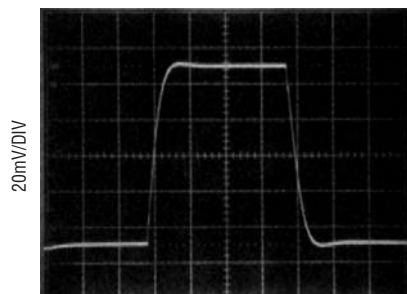

20μs/DIV

LT1101 • TPC20.6

Small Signal Transient Response
 $G = 100, V_S = 5V, 0V$

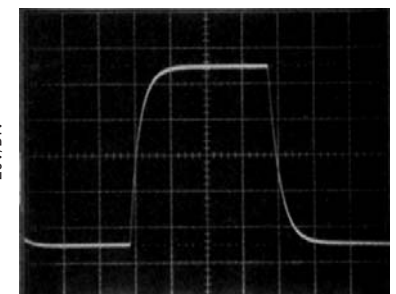

200μs/DIV
OUTPUT FROM 0.05V TO 0.15V, NO LOAD
(RESPONSE WITH $V_S = \pm 15V, G = 100$ IS IDENTICAL)

LT1101 • TPC20.7

TYPICAL PERFORMANCE CHARACTERISTICS

Single Supply: Minimum Common Mode Voltage vs Output Voltage



LT1101 • TPC21

Single Supply: Minimum Output Voltage vs Common Mode Voltage



LT1101 • TPC22

Minimum Supply Voltage vs Temperature

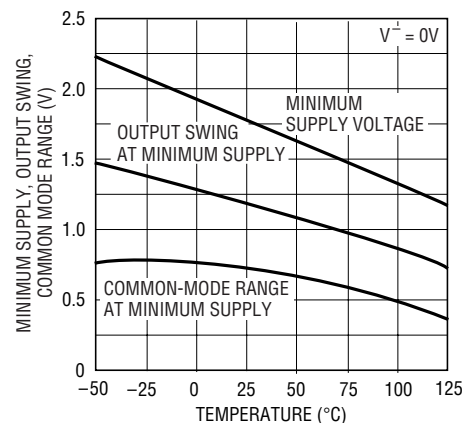

LT1101 • TPC23

APPLICATIONS INFORMATION

Single Supply Applications

The LT1101 is the first instrumentation amplifier which is fully specified for single supply operation, (i.e. when the negative supply is 0V). Both the input common mode range and the output swing are within a few millivolts of ground.

Probably the most common application for instrumentation amplifiers is amplifying a differential signal from a transducer or sensor resistance bridge. All competitive instrumentation amplifiers have a minimum required common mode voltage which is 3V to 5V above the negative supply. This means that the voltage across the bridge has to be 6V to 10V or dual supplies have to be used (i.e., micropower) single battery usage is not attainable on competitive devices.

The minimum output voltage obtainable on the LT1101 is a function of the input common mode voltage. When the common mode voltage is high and the output is low, current will flow from the output of amplifier A into the output of amplifier B. See the Minimum Output Voltage vs Common Mode Voltage plot.

Similarly, the Single Supply Minimum Common Mode Voltage vs Output Voltage plot specifies the expected common mode range.

When the output is high and input common mode is low, the output of amplifier A has to sink current coming from the output of amplifier B. Since amplifier A is effectively in unity gain, its input is limited by its output.

Common Mode Rejection vs Frequency

The common mode rejection ratio (CMRR) of the LT1101 starts to roll off at a relatively low frequency. However, as shown on the Common Mode Rejection Ratio vs Frequency plot, CMRR can be enhanced significantly by connecting an 82pF capacitor between pins 1 and 2. This improvement is only available in the gain 100 configuration, and it is in excess of 30dB at 60Hz.

Offset Nulling

The LT1101 is not equipped with dedicated offset null terminals. In many bridge transducer or sensor applications, calibrating the bridge simultaneously eliminates the instrumentation amplifier's offset as a source of error. For example, in the Micropower Remote Temperature Sensor Application shown, one adjustment removes the offset errors due to the temperature sensor, voltage reference and the LT1101.

APPLICATIONS INFORMATION

A simple resistive offset adjust procedure is shown below. If $R = 5\Omega$ for $G = 10$, and $R = 50\Omega$ for $G = 100$, then the effect of R on gain error is approximately 0.006%. Unfortunately, about $450\mu\text{A}$ has to flow through R to bias the reference terminal (Pin 1) and to null out the worst-case offset voltage. The total current through the resistor network can exceed 1mA, and the micropower advantage of the LT1101 is lost.



Another offset adjust scheme uses the LT1077 micropower op amp to drive the reference Pin 1. Gain error and common mode rejection are unaffected, the total current increase is $45\mu\text{A}$. The offset of the LT1077 is trimmed and amplified to match and cancel the offset voltage of the LT1101. Output offset null range is $\pm 25\text{mV}$.

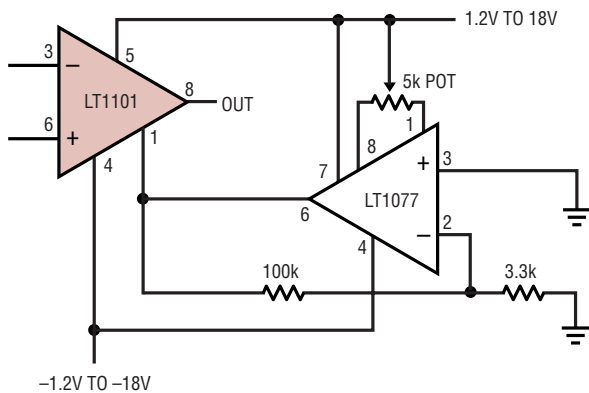

Gains Between 10 and 100

Gains between 10 and 100 can be achieved by connecting two equal resistors ($= R_x$) between Pins 1 and 2 and Pins 7 and 8.

$$\text{Gain} = 10 + \frac{R_x}{R + R_x/90}$$

The nominal value of R is $9.2\text{k}\Omega$. The usefulness of this method is limited by the fact that R is not controlled to better than $\pm 10\%$ absolute accuracy in production. However, on any specific unit, $90R$ can be measured between Pins 1 and 2.

Input Protection

Instrumentation amplifiers are often used in harsh environments where overload conditions can occur. The LT1101 employs PNP input transistors, consequently the differential input voltage can be $\pm 30\text{V}$ (with $\pm 15\text{V}$ supplies, $\pm 36\text{V}$ with $\pm 18\text{V}$ supplies) without an increase in input bias current. Competitive instrumentation amplifiers have NPN inputs which are protected by back-to-back diodes. When the differential input voltage exceeds $\pm 1.3\text{V}$ on these competitive devices, input current increases to the milliampere level; more than $\pm 10\text{V}$ differential voltage can cause permanent damage.

When the LT1101's inputs are pulled above the positive supply, the inputs will clamp a diode voltage above the positive supply. No damage will occur if the input current is limited to 20mA.

500Ω resistors in series with the inputs protect the LT1101 when the inputs are pulled as much as 10V below the negative supply.

APPLICATIONS INFORMATION

Micropower, Battery Operated Remote Temperature Sensor

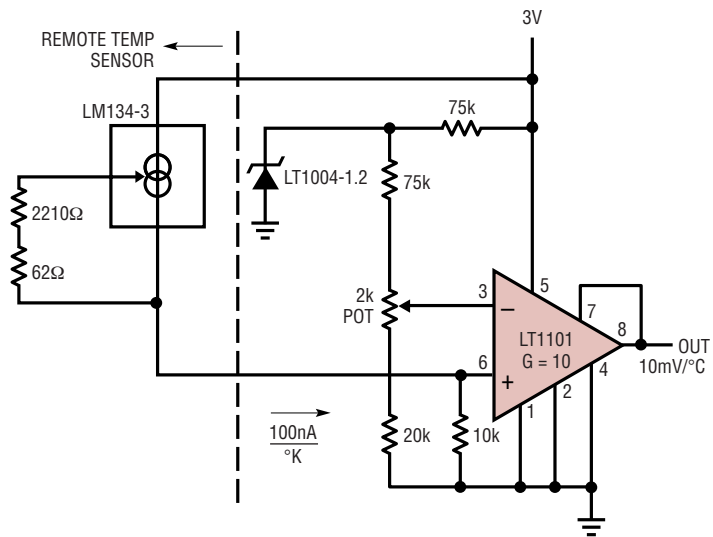

TRIM OUTPUT TO 250mV AT 25°C
 TEMPERATURE RANGE = 2.5°C TO 150°C
 ACCURACY = ±0.5°C

LT1101 • AI03

4mA to 20mA Loop Receiver

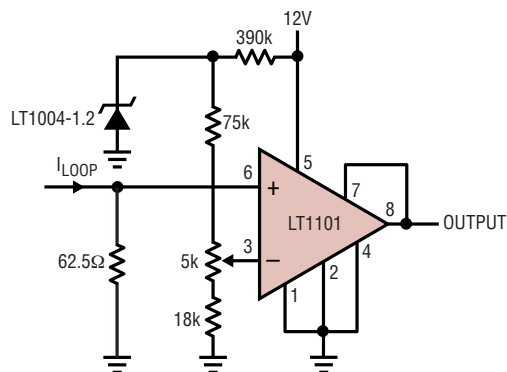

4mA TO 20mA IN – 0V TO 10V OUT
 TRIM OUTPUT TO 5V AT 12mA IN

LT1101 • AI04

Instrumentation Amplifier with ±150mA Output Current

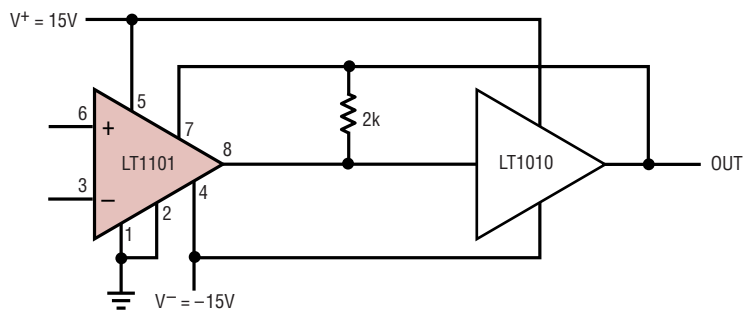

GAIN = 10, DEGRADED BY 0.01% DUE TO LT1010
 OUTPUT = ±10V INTO 75Ω (TO 1.5kHz)
 DRIVES ANY CAPACITIVE LOAD
 SINGLE SUPPLY APPLICATION (V+ = 5V, V- = 0V):
 V_{OUT MIN} = 120mV, V_{OUT MAX} = 3.4V

LT1101 • AI05

Voltage Controlled Current Source

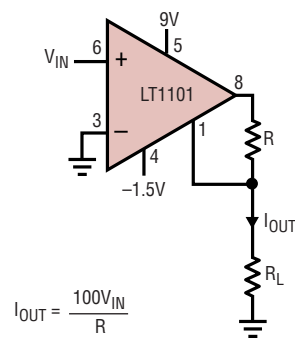

$$I_{OUT} = \frac{100V_{IN}}{R}$$

I_{OUT} = 0mA TO 5mA
 VOLTAGE COMPLIANCE = 6.4V
 (R ≤ 200Ω)

LT1101 • AI06

APPLICATIONS INFORMATION

Differential Voltage Amplification from a Resistance Bridge



Gain = 20, 110 or 200 Instrumentation Amplifier

Differential Output



Single Ended Output



GAIN = 200, AS SHOWN
 GAIN = 20, SHORT PIN 1 TO PIN 2, PIN 7 TO PIN 8
 ON BOTH DEVICES
 GAIN = 110, SHORT PIN 1 TO PIN 2, PIN 7 TO PIN 8
 ON ONE DEVICE, NOT ON THE OTHER
 INPUT REFERRED NOISE IS REDUCED BY $\sqrt{2}$ (G = 200 OR 20)

LT1101 • A108

PACKAGE DESCRIPTION

N8 Package
8-Lead PDIP (Narrow .300 Inch)
 (Reference LTC DWG # 05-08-1510)



NOTE:
 1. DIMENSIONS ARE $\frac{\text{INCHES}}{\text{MILLIMETERS}}$
 *THESE DIMENSIONS DO NOT INCLUDE MOLD FLASH OR PROTRUSIONS.
 MOLD FLASH OR PROTRUSIONS SHALL NOT EXCEED .010 INCH (0.254mm)

SW Package
16-Lead Plastic Small Outline (Wide .300 Inch)
 (Reference LTC DWG # 05-08-1620)

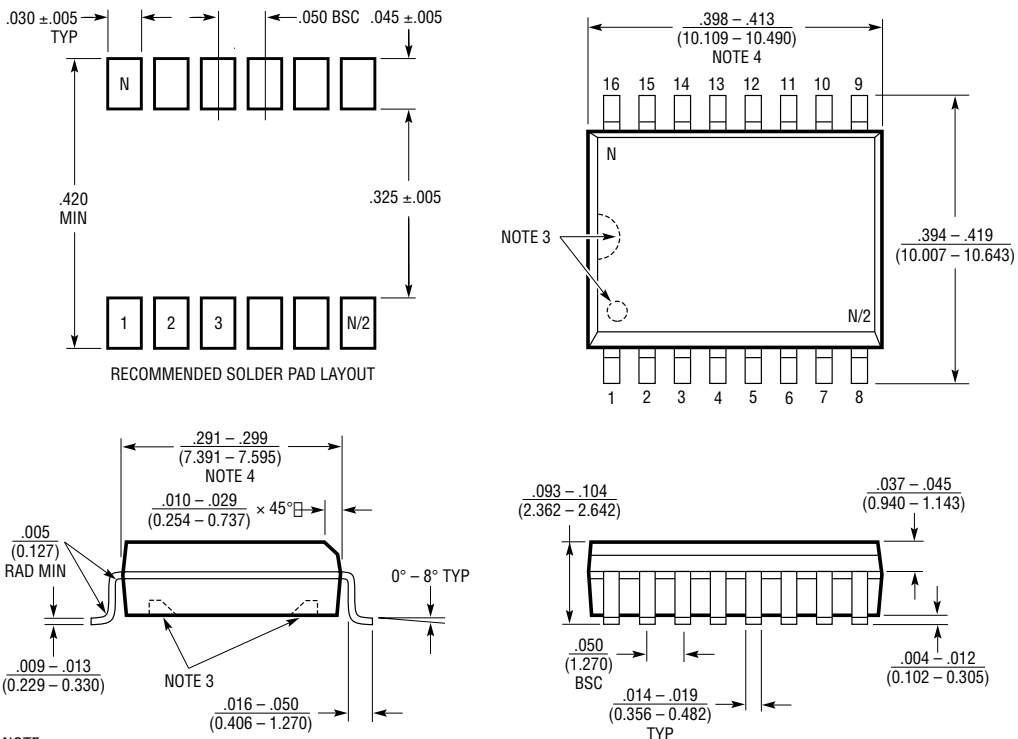

NOTE:
 1. DIMENSIONS IN $\frac{\text{INCHES}}{\text{MILLIMETERS}}$
 2. DRAWING NOT TO SCALE
 3. PIN 1 IDENT, NOTCH ON TOP AND CAVITIES ON THE BOTTOM OF PACKAGES ARE THE MANUFACTURING OPTIONS.
 THE PART MAY BE SUPPLIED WITH OR WITHOUT ANY OF THE OPTIONS
 4. THESE DIMENSIONS DO NOT INCLUDE MOLD FLASH OR PROTRUSIONS.
 MOLD FLASH OR PROTRUSIONS SHALL NOT EXCEED .006" (0.15mm)

S16 (WIDE) 0502

Компания «Океан Электроники» предлагает заключение долгосрочных отношений при поставках импортных электронных компонентов на взаимовыгодных условиях!

Наши преимущества:

- Поставка оригинальных импортных электронных компонентов напрямую с производств Америки, Европы и Азии, а так же с крупнейших складов мира;
- Широкая линейка поставок активных и пассивных импортных электронных компонентов (более 30 млн. наименований);
- Поставка сложных, дефицитных, либо снятых с производства позиций;
- Оперативные сроки поставки под заказ (от 5 рабочих дней);
- Экспресс доставка в любую точку России;
- Помощь Конструкторского Отдела и консультации квалифицированных инженеров;
- Техническая поддержка проекта, помощь в подборе аналогов, поставка прототипов;
- Поставка электронных компонентов под контролем ВП;
- Система менеджмента качества сертифицирована по Международному стандарту ISO 9001;
- При необходимости вся продукция военного и аэрокосмического назначения проходит испытания и сертификацию в лаборатории (по согласованию с заказчиком);
- Поставка специализированных компонентов военного и аэрокосмического уровня качества (Xilinx, Altera, Analog Devices, Intersil, Interpoint, Microsemi, Actel, Aeroflex, Peregrine, VPT, Syfer, Eurofarad, Texas Instruments, MS Kennedy, Miteq, Cobham, E2V, MA-COM, Hittite, Mini-Circuits, General Dynamics и др.);

Компания «Океан Электроники» является официальным дистрибьютором и эксклюзивным представителем в России одного из крупнейших производителей разъемов военного и аэрокосмического назначения «JONHON», а так же официальным дистрибьютором и эксклюзивным представителем в России производителя высокотехнологичных и надежных решений для передачи СВЧ сигналов «FORSTAR».



JONHON

«JONHON» (основан в 1970 г.)

Разъемы специального, военного и аэрокосмического назначения:

(Применяются в военной, авиационной, аэрокосмической, морской, железнодорожной, горно- и нефтедобывающей отраслях промышленности)

«FORSTAR» (основан в 1998 г.)

ВЧ соединители, коаксиальные кабели, кабельные сборки и микроволновые компоненты:

(Применяются в телекоммуникациях гражданского и специального назначения, в средствах связи, РЛС, а так же военной, авиационной и аэрокосмической отраслях промышленности).



Телефон: 8 (812) 309-75-97 (многоканальный)

Факс: 8 (812) 320-03-32

Электронная почта: ocean@oceanchips.ru

Web: <http://oceanchips.ru/>

Адрес: 198099, г. Санкт-Петербург, ул. Калинина, д. 2, корп. 4, лит. А