

THIS DRAWING IS UNPUBLISHED. RELEASED FOR PUBLICATION AUG ,2006.

© COPYRIGHT BY TYCO ELECTRONICS CORPORATION. ALL RIGHTS RESERVED.

LOC	DIST	REVISIONS			
P	LTR	DESCRIPTION	DATE	DWN	APVD
		E1	REVISED. ECR-12-013026	25MAR13	K.M E.T

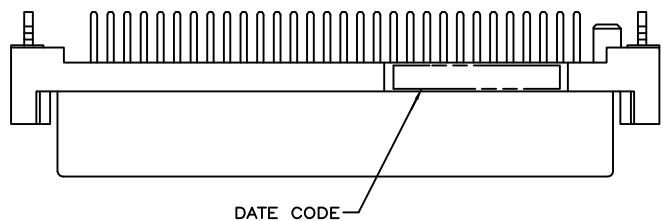

- MATERIALS:**
 HOUSING- PPA RESIN, BLACK, MOLDING COMPOUND.
 CONTACTS- PHOSPHOR BRONZE PLATED WITH MINIMUM THICK (SEE TABLE) GOLD IN CONTACT AREA AND 3.8μm [.000150] MINIMUM THICK MATTE TIN ON SOLDER TINES OVER 1.27μm [.000050] MINIMUM THICK NICKEL UNDERPLATE.
 RETENTION LEG- BRASS PLATED WITH 3.8μm [.000150] MINIMUM TIN-Cu OVER 1.3μm [.000051] MINIMUM NICKEL UNDERPLATE.
- G, J, AND H INDICATE NUMBER OF POSITION MARKED ON ASSEMBLY. ALSO SEE TABLE.
 ALL DIMENSIONS SHOWN ARE MAXIMUM UNLESS OTHERWISE SPECIFIED.
 4. 60 POSITION AS SHOWN.
 RETENTION LEGS NOT PRESENT.
 TOP OF RETENTION LEG MAY NOT PROTRUDE ABOVE THIS SURFACE.
 HOUSING BOW UP TO 0.30 [.012] ALLOWED.
 CONNECTOR WILL ACCOMMODATE MATING PRINTED CIRCUIT BOARD OF 1.6±0.07 [.063±.003] THICKNESS.
 ALWAYS RoHS/ELV COMPLIANT.
 WAVE SOLDER CAPABLE TO 265 C PER TE SPEC 109-202, CONDITION B.
 REMOVE CONTACT POSITION FROM #11~#17 AND #36~#42.
 RECOMMEND CARD EDGE DIM. (PAGE2)
 GOLD FLASH OVER 0.762μm [30μ"] MIN. PALLADIUM-NICKEL PLATED.
 OBSOLETE

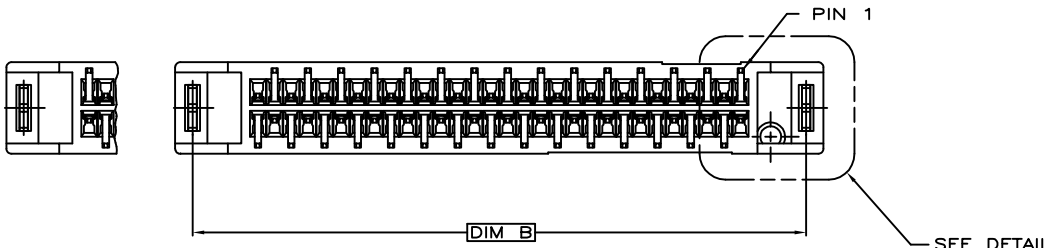
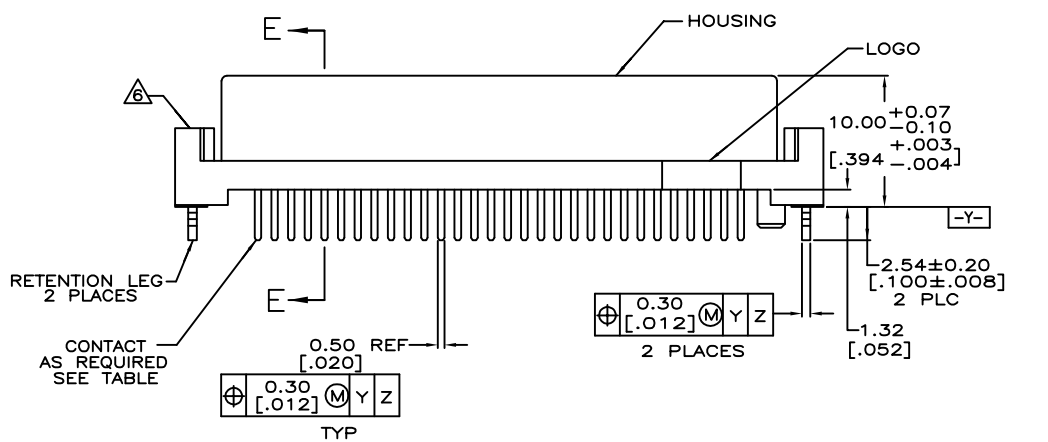
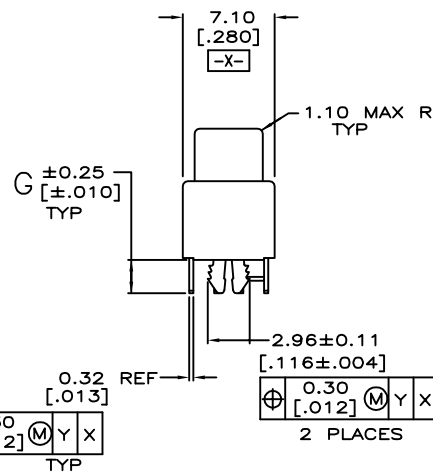
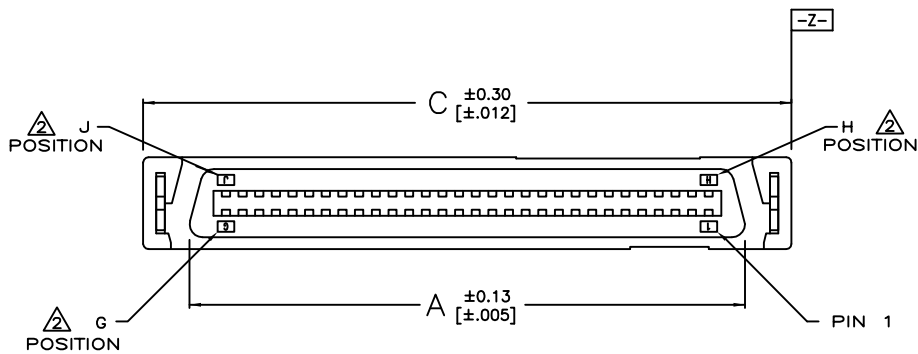

LOC	DIST	P	LTR	DESCRIPTION	DATE	DWN	APVD
E1				GOLD FLASH	5-1734101-6		
E1		2.36	3.30	127.43	138.35	135.71	131.27
E1		[.093]	[.130]	[5.017]	[5.447]	[5.343]	[5.168]
E1				0.381um[15u"]	3-1734101-6		
E1					1-1734101-6		
E1		0.8-1.6	2.54	127.43	138.35	135.71	131.27
E1		[.031-.063]	[.100]	[5.017]	[5.447]	[5.343]	[5.168]
E1				0.381um[15u"]	3-1734101-5		
E1					1-1734101-5		
E1		0.8-1.6	2.54	102.03	112.95	110.31	105.87
E1		[.031-.063]	[.100]	[4.017]	[4.447]	[4.343]	[4.168]
E1				GOLD FLASH	5-1734101-4		
E1				0.381um[15u"]	3-1734101-4		
E1					1-1734101-4		
E1		2.36	3.30	76.63	87.55	84.91	80.47
E1		[.093]	[.130]	[3.017]	[3.447]	[3.343]	[3.168]
E1				GOLD FLASH	5-1734101-3		
E1				0.381um[15u"]	3-1734101-3		
E1					1-1734101-3		
E1		0.8-1.6	2.54	76.63	87.55	84.91	80.47
E1		[.031-.063]	[.100]	[3.017]	[3.447]	[3.343]	[3.168]
E1				GOLD FLASH	5-1734101-2		
E1				0.381um[15u"]	3-1734101-2		
E1					1-1734101-2		
E1		2.36	3.30	63.93	74.85	72.21	67.77
E1		[.093]	[.130]	[2.517]	[2.947]	[2.843]	[2.668]
E1				GOLD FLASH	5-1734101-1		
E1				0.381um[15u"]	3-1734101-1		
E1					1-1734101-1		
E1		0.8-1.6	2.54	63.93	74.85	72.21	67.77
E1		[.031-.063]	[.100]	[2.517]	[2.947]	[2.843]	[2.668]
E1				GOLD FLASH	5-1734101-0		
E1				0.381um[15u"]	3-1734101-0		
E1					1-1734101-0		
E1		0.8-1.6	2.54	51.23	62.15	59.51	55.07
E1		[.031-.063]	[.100]	[2.017]	[2.447]	[2.343]	[2.168]
E1				GOLD FLASH	5-1734101-8		
E1				0.381um[15u"]	3-1734101-8		
E1					1-1734101-8		
E1		2.36	3.30	51.23	62.15	59.51	55.07
E1		[.093]	[.130]	[2.017]	[2.447]	[2.343]	[2.168]
E1				GOLD FLASH	4-1734101-9		
E1				0.381um[15u"]	6-1734101-9		
E1					1734101-9		
E1		0.8-1.6	2.54	51.23	62.15	59.51	55.07
E1		[.031-.063]	[.100]	[2.017]	[2.447]	[2.343]	[2.168]
E1				GOLD FLASH	4-1734101-8		
E1				0.381um[15u"]	6-1734101-8		
E1					1734101-8		
E1		0.8-1.6	2.54	43.61	54.53	51.89	47.45
E1		[.031-.063]	[.100]	[1.717]	[2.147]	[2.043]	[1.868]
E1				GOLD FLASH	4-1734101-7		
E1				0.381um[15u"]	6-1734101-7		
E1					1734101-7		
E1		2.36	3.40	38.53	49.45	46.81	42.37
E1		[.093]	[.134]	[1.517]	[1.947]	[1.843]	[1.668]
E1				GOLD FLASH	4-1734101-6		
E1				0.381um[15u"]	6-1734101-6		
E1					1734101-6		
E1		2.36	3.30	32.18	43.10	40.46	36.02
E1		[.093]	[.100]	[1.267]	[1.697]	[1.593]	[1.418]
E1				GOLD FLASH	5-1734101-7		
E1				0.381um[15u"]	3-1734101-7		
E1					1-1734101-7		
E1		0.8-1.6	2.54	32.18	43.10	40.46	36.02
E1		[.031-.063]	[.100]	[1.267]	[1.697]	[1.593]	[1.418]
E1				GOLD FLASH	4-1734101-5		
E1				0.381um[15u"]	6-1734101-5		
E1					1734101-5		
E1		0.8-1.6	2.54	25.83	36.75	34.11	29.67
E1		[.031-.063]	[.100]	[1.017]	[1.447]	[1.343]	[1.168]
E1				GOLD FLASH	4-1734101-4		
E1				0.381um[15u"]	6-1734101-4		
E1					1734101-4		
E1		0.8-1.6	2.54	-	30.40	27.96	23.32
E1		[.031-.063]	[.100]	-	[1.197]	[1.101]	[.918]
E1				GOLD FLASH	4-1734101-3		
E1				0.381um[15u"]	6-1734101-3		
E1					1734101-3		

THIS DRAWING IS A CONTROLLED DOCUMENT.

DIMENSIONS: MM

TOLERANCES UNLESS OTHERWISE SPECIFIED:

0 PLC	± -
1 PLC	± -
2 PLC	± -
3 PLC	± -
4 PLC	± -
ANGLES	± -

MATERIAL: SEE NOTE

FINISH: SEE NOTE

TE Connectivity

RECEPTACLE ASSEMBLY, VERTICAL, BOARD-TO-BOARD, CHAMP.050, SERIES I,

108-57876

QUALIFICATION TEST REPORT

SIZE: A3

CAGE CODE: 00779

DRAWING NO: C=1734101

RESTRICTED TO

CUSTOMER DRAWING

SCALE: -

SHEET: 1 OF 4

REV: E1

4

3

2

1

THIS DRAWING IS UNPUBLISHED. RELEASED FOR PUBLICATION AUG .2006.
 © COPYRIGHT - BY TYCO ELECTRONICS CORPORATION. ALL RIGHTS RESERVED.

LOC	DIST	REVISIONS					
DW		P	LTR	DESCRIPTION	DATE	DWN	APVD
				SEE SHEET 1.			

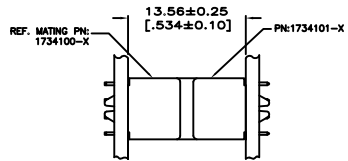
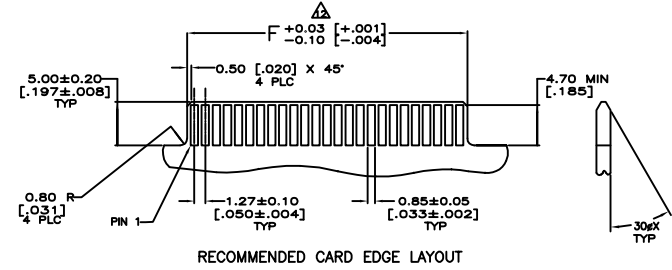
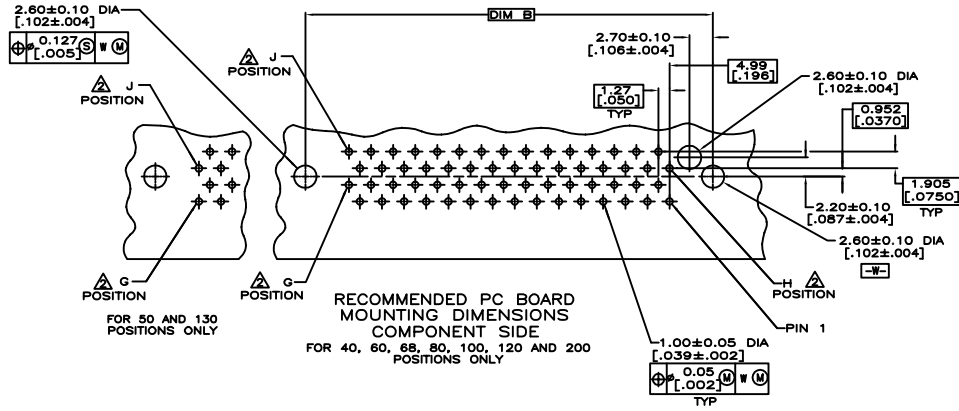

VERTICAL RECEPTACLE ASSEMBLY MATED TO VERTICAL PLUG ASSEMBLY

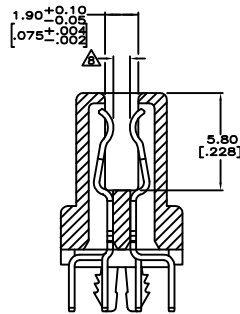

SECTION E-E SCALE 8:1

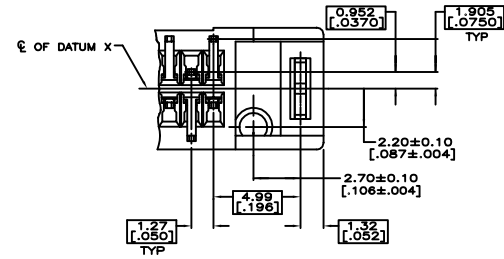

DETAIL D SCALE 8:1

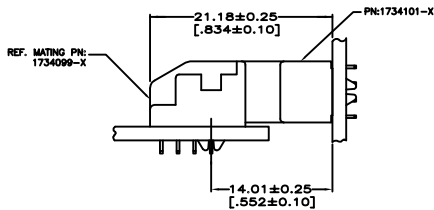

VERTICAL RECEPTACLE ASSEMBLY MATED TO VERTICAL PLUG ASSEMBLY

THIS DRAWING IS A CONTROLLED DOCUMENT.		DWN				
DIMENSIONS: MM		CHK				
TOLERANCES UNLESS OTHERWISE SPECIFIED:		APVD	NAME			
0 PLC ± - 1 PLC ± - 2 PLC ± - 3 PLC ± - 4 PLC ± - ANGLES ± -		PRODUCT SPEC	RECEPTACLE ASSEMBLY, VERTICAL, BOARD-TO-BOARD, CHAMP.050, SERIES I,			
MATERIAL		QUALIFICATION TEST REPORT	SIZE	CAGE CODE	DRAWING NO	RESTRICTED TO
FINISH		WEIGHT	A3	00779	C=1734101	
CUSTOMER DRAWING			SCALE	SHEET	2 of 4	REV E1

LOC	DIST	REVISIONS				
P	LTR	DESCRIPTION	DATE	DWN	APVD	
		SEE SHEET 1.				

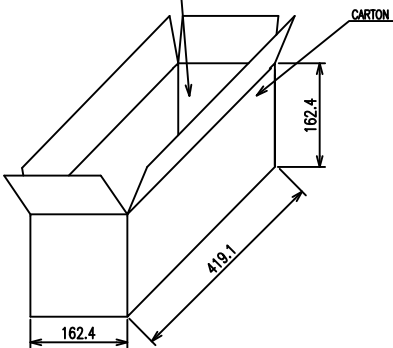
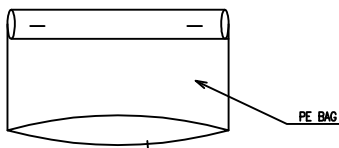
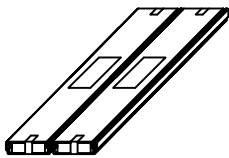
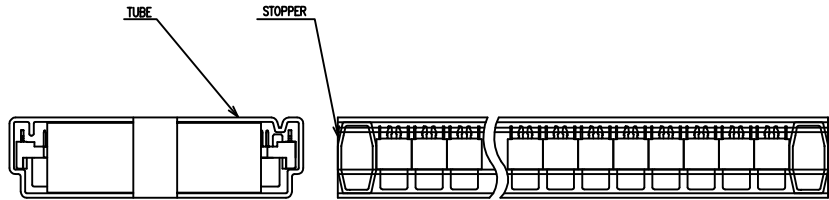

QTY	DESCRIPTION	DATE	DWN	APVD	POS.		
120	OBsolete				5-1734101-3 3-1734101-3 1-1734101-3 5-1734101-2 3-1734101-2 1-1734101-2		
100	OBsolete				6-1734101-1 3-1734101-1 1-1734101-1 5-1734101-0 3-1734101-0 1-1734101-0		
80	OBsolete				5-1734101-8 3-1734101-8 1-1734101-8 4-1734101-8 6-1734101-8 1734101-8		
68					4-1734101-7 6-1734101-7 1734101-7		
60					4-1734101-6 6-1734101-6 1734101-6		
50	OBsolete				2-1734101-7 5-1734101-7 3-1734101-7 1-1734101-7 4-1734101-5 6-1734101-5 1734101-5		
40					4-1734101-4 6-1734101-4 1734101-4		
30					4-1734101-3 6-1734101-3 1734101-3		
	G.W./CARTON (KG)	N.W./CARTON (KG)	PCS/TUBE	TUBES/CARTON	QUANTITY/CARTON (PCS)	PART NUMBER	POS.

THIS DRAWING IS A CONTROLLED DOCUMENT.		DWN		TE Connectivity RECEPTACLE ASSEMBLY, VERTICAL, BOARD-TO-BOARD, CHAMP.050, SERIES I,	
DIMENSIONS: MM		CHK			
TOLERANCES UNLESS OTHERWISE SPECIFIED:		APVD		NAME	
0 PLC ± - 1 PLC ± - 2 PLC ± - 3 PLC ± - 4 PLC ± - ANGLES ± -		PRODUCT SPEC		SIZE	
MATERIAL		QUALIFICATION TEST REPORT		CAGE CODE	
FINISH		WEIGHT		DRAWING NO	
		CUSTOMER DRAWING		A300779 C=1734101	
		SCALE		RESTRICTED TO	
		SHEET 3 OF 4		REV E1	

4

3

2

1

THIS DRAWING IS UNPUBLISHED. RELEASED FOR PUBLICATION AUG. 2006.
 © COPYRIGHT BY TYCO ELECTRONICS CORPORATION. ALL RIGHTS RESERVED.

LOC	DIST	REVISIONS			
P	LTR	DESCRIPTION	DATE	DWN	APVD
		SEE SHEET 1.			

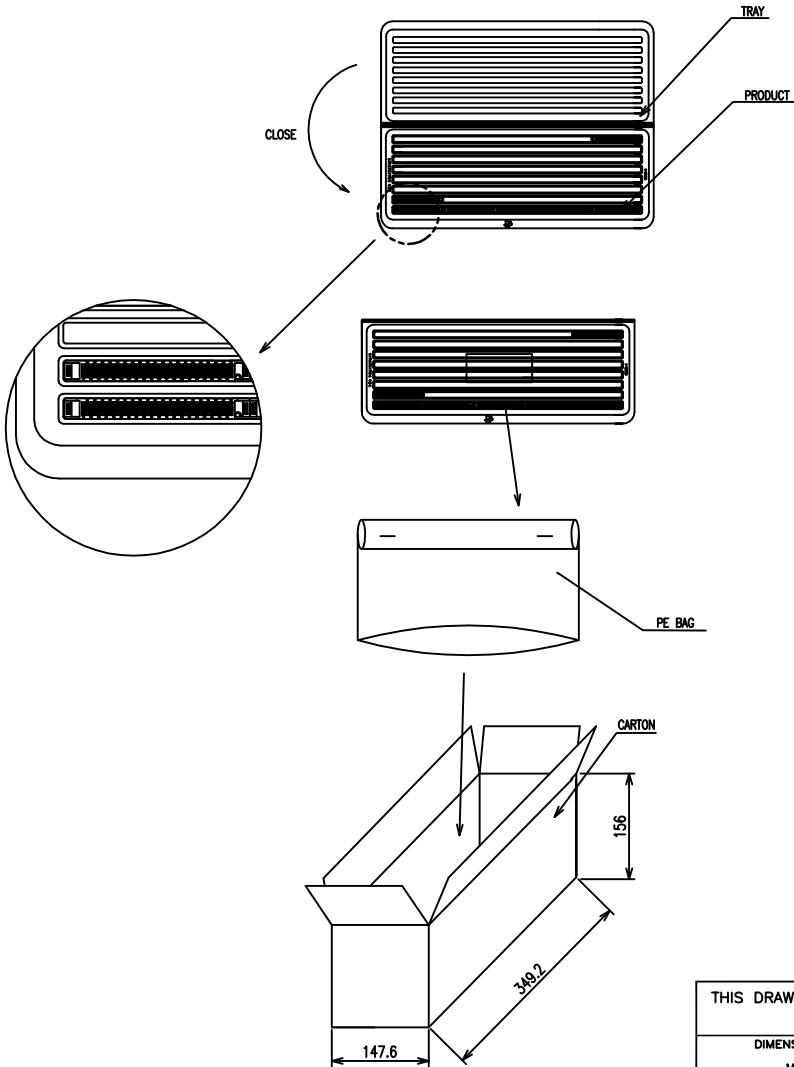

E1	OBSOLETE						5-1734101-6	200
		2.69	1.71	16	10	160	3-1734101-6	
							1-1734101-6	
							5-1734101-5	
							3-1734101-5	
E1	OBSOLETE						1-1734101-6	160
		2.37	1.39	16	10	160	5-1734101-4	
							3-1734101-4	
							1-1734101-4	
							4-1734101-9	
						6-1734101-9	80	
					1734101-9			
		G.W./CARTON (KG)	N.W./CARTON (KG)	PCS/TRAY	TRAYS/CARTON	QUANTITY/CARTON (PCS)	PART NUMBER	POS.

THIS DRAWING IS A CONTROLLED DOCUMENT.		DWN	TE TE Connectivity			
DIMENSIONS: MM		CHK				
TOLERANCES UNLESS OTHERWISE SPECIFIED:		APVD	NAME			
0 PLC ± -		PRODUCT SPEC	RECEPTACLE ASSEMBLY, VERTICAL, BOARD-TO-BOARD, CHAMP.050, SERIES I,			
1 PLC ± -		QUALIFICATION TEST REPORT	SIZE	CAGE CODE	DRAWING NO	RESTRICTED TO
2 PLC ± -			A3	00779	C=1734101	
3 PLC ± -		WEIGHT	CUSTOMER DRAWING			
4 PLC ± -			SCALE	SHEET	REV	
ANGLES ± -				4 OF 4	E1	
FINISH						

Компания «Океан Электроники» предлагает заключение долгосрочных отношений при поставках импортных электронных компонентов на взаимовыгодных условиях!

Наши преимущества:

- Поставка оригинальных импортных электронных компонентов напрямую с производств Америки, Европы и Азии, а так же с крупнейших складов мира;
- Широкая линейка поставок активных и пассивных импортных электронных компонентов (более 30 млн. наименований);
- Поставка сложных, дефицитных, либо снятых с производства позиций;
- Оперативные сроки поставки под заказ (от 5 рабочих дней);
- Экспресс доставка в любую точку России;
- Помощь Конструкторского Отдела и консультации квалифицированных инженеров;
- Техническая поддержка проекта, помощь в подборе аналогов, поставка прототипов;
- Поставка электронных компонентов под контролем ВП;
- Система менеджмента качества сертифицирована по Международному стандарту ISO 9001;
- При необходимости вся продукция военного и аэрокосмического назначения проходит испытания и сертификацию в лаборатории (по согласованию с заказчиком);
- Поставка специализированных компонентов военного и аэрокосмического уровня качества (Xilinx, Altera, Analog Devices, Intersil, Interpoint, Microsemi, Actel, Aeroflex, Peregrine, VPT, Syfer, Eurofarad, Texas Instruments, MS Kennedy, Miteq, Cobham, E2V, MA-COM, Hittite, Mini-Circuits, General Dynamics и др.);

Компания «Океан Электроники» является официальным дистрибьютором и эксклюзивным представителем в России одного из крупнейших производителей разъемов военного и аэрокосмического назначения «JONHON», а так же официальным дистрибьютором и эксклюзивным представителем в России производителя высокотехнологичных и надежных решений для передачи СВЧ сигналов «FORSTAR».



JONHON

«JONHON» (основан в 1970 г.)

Разъемы специального, военного и аэрокосмического назначения:

(Применяются в военной, авиационной, аэрокосмической, морской, железнодорожной, горно- и нефтедобывающей отраслях промышленности)

«FORSTAR» (основан в 1998 г.)

ВЧ соединители, коаксиальные кабели, кабельные сборки и микроволновые компоненты:

(Применяются в телекоммуникациях гражданского и специального назначения, в средствах связи, РЛС, а так же военной, авиационной и аэрокосмической отраслях промышленности).



Телефон: 8 (812) 309-75-97 (многоканальный)

Факс: 8 (812) 320-03-32

Электронная почта: ocean@oceanchips.ru

Web: <http://oceanchips.ru/>

Адрес: 198099, г. Санкт-Петербург, ул. Калинина, д. 2, корп. 4, лит. А