

# Miniature Rotary DIP Switch A6K/A6KS

## Miniature (7.2 × 7.2mm size) Rotary DIP Switch

- Mounting space reduced by 50%.  
(compared with conventional models)
- SMT and through hole type Available.  
Side-actuated type available.
- Gold-plated contacts ensure high reliability.
- RoHS Compliant

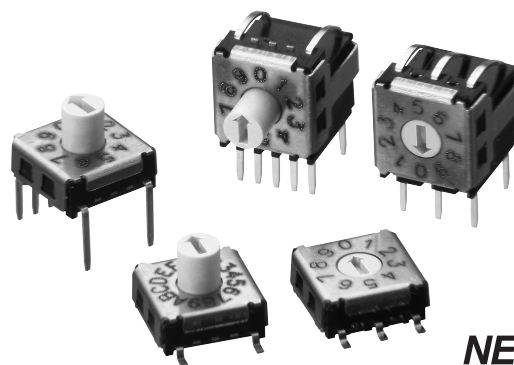

**NEW**

## Ordering Information

### ■ Through hole type

3 × 3 Terminal, tube packaging			Top-actuated flat	Top-actuated extended shaft	Side-actuated flat	Side-actuated extended shaft
<b>Output code</b>	<b>No. of positions</b>	<b>Quantity per tube</b>				
BCD 1-2-4-8	10	Top: 63	<b>A6K-102RF</b>	<b>A6K-102RS</b>	<b>A6KV-102RF</b>	<b>A6KV-102RS</b>
BCD Hexadecimal 1-2-4-8	16	Side: 60	<b>A6K-162RF</b>	<b>A6K-162RS</b>	<b>A6KV-162RF</b>	<b>A6KV-162RS</b>



5 × 2 Terminal, tube packaging			Top-actuated flat	Top-actuated extended shaft	Side-actuated flat	Side-actuated extended shaft
<b>Output code</b>	<b>No. of positions</b>	<b>Quantity per tube</b>				
BCD 1-2-4-8	10	Top: 63	<b>A6K-104RF</b>	<b>A6K-104RS</b>	<b>A6KV-104RF</b>	<b>A6KV-104RS</b>
BCD Hexadecimal 1-2-4-8	16	Side: 60	<b>A6K-164RF</b>	<b>A6K-164RS</b>	<b>A6KV-164RF</b>	<b>A6KV-164RS</b>

### ■ SMT type

3 × 3 Terminal, tube packaging			Top-actuated flat	Top-actuated extended shaft
<b>Output code</b>	<b>No. of positions</b>	<b>Quantity per tube</b>		
BCD 1-2-4-8	10	63	<b>A6KS-102RF</b>	<b>A6KS-102RS</b>
BCD Hexadecimal 1-2-4-8	16		<b>A6KS-162RF</b>	<b>A6KS-162RS</b>

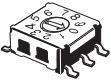
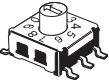
5 × 2 Terminal, tube packaging			Top-actuated flat	Top-actuated extended shaft	Side-actuated flat	Side-actuated extended shaft
<b>Output code</b>	<b>No. of positions</b>	<b>Quantity per tube</b>				
BCD 1-2-4-8	10	63	<b>A6KS-104RF</b>	<b>A6KS-104RS</b>	<b>A6KSV-104RF</b>	<b>A6KSV-104RS</b>
BCD Hexadecimal 1-2-4-8	16		<b>A6KS-164RF</b>	<b>A6KS-164RS</b>	<b>A6KSV-164RF</b>	<b>A6KSV-164RS</b>

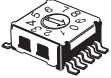
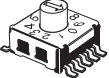
3 × 3 Terminal Embossed Taping Packages		Top-actuated flat		Top-actuated extended shaft	
		Quantity per reel		Quantity per reel	
Output code	No. of positions				
BCD 1-2-4-8	10	1450	A6KS-102RF-P	850	A6KS-102RS-P
BCD Hexadecimal 1-2-4-8	16		A6KS-162RF-P		A6KS-162RS-P

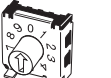
5 × 2 Terminal Embossed Taping Packages		Top-actuated flat		Top-actuated extended shaft		Side-actuated flat		Side-actuated extended shaft	
		Quantity per reel		Quantity per reel		Quantity per reel		Quantity per reel	
Output code	No. of positions								
BCD 1-2-4-8	10	1450	A6KS-104RF-P	850	A6KS-104RS-P	750	A6KSV-104RF-P	750	A6KSV-104RS-P
BCD Hexadecimal 1-2-4-8	16		A6KS-164RF-P		A6KS-164RS-P		A6KSV-164RF-P		A6KSV-164RS-P

## Specifications

### Characteristics

Switching capacity	25 mA at 24 VDC	
Minimum permissible load	10 μA at 3.5 VDC	
Contact resistance	200 mΩ max.	
Insulation resistance	100 MΩ min. (at 250 VDC)	
Dielectric strength	250 VAC for 1 min between terminals	
Operating torque	200 g·cm max. (1.96 × 10 <sup>-2</sup> N·m max.)	
Vibration resistance	Malfunction durability	10 to 55 Hz, 1.5-mm double amplitude
Shock resistance	Malfunction durability	300 m/s <sup>2</sup> min.
Ambient operating temperature	-30 to 80°C at 60% max. (with no icing or condensation)	
Ambient operating humidity	35% to 95% (at 5 to 35°C)	
Electrical service life	20,000 steps min.	
Weight (See note 2.)	Through hole terminal	Top-actuated, flat: Approx. 0.4 g, Side-actuated, flat: Approx. 0.7 g
	SMT terminal	Top-actuated, flat: Approx. 0.4 g, Side-actuated, flat: Approx. 0.4 g

Note: 1. Data shown are of initial value.  
2. Add 0.03 g for the extended-shaft version of each model.

### Output Codes

#### 10-position Models

Type	BCD 1-2-4-8				
	Terminal No. Position	1	2	4	8
0					
1		●			
2			●		
3		●	●		
4				●	
5		●		●	
6			●	●	
7		●	●	●	
8					●
9		●			●

#### 16-position Models

Type	BCD/hexadecimal 1-2-4-8				
	Terminal No. Position	1	2	4	8
0					
1		●			
2			●		
3		●	●		
4				●	
5		●		●	
6			●	●	
7		●	●	●	
8					●
9		●			●
A			●		●
B		●	●		●
C				●	●
D		●		●	●
E			●	●	●
F		●	●	●	●

Note: "●" indicates that the internal switch is ON.

# Dimensions

**Note:** 1. All units are in millimeters unless otherwise indicated.  
 2. Unless otherwise specified, a tolerance of  $\pm 0.4$  mm applies to all dimensions.

## Through hole type

### Top-actuated Flat Models with 3x3 Terminal Arrangement

A6K-102RF  
 A6K-162RF



### Top-actuated Extended shaft Models with 3x3 Terminal Arrangement

A6K-102RS  
 A6K-162RS

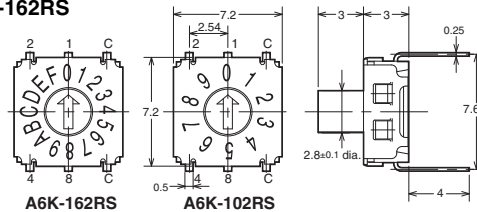

### Side-actuated Flat Models with 3x3 Terminal Arrangement

A6KV-102RF  
 A6KV-162RF



### Side-actuated Extended-shaft Models with 3x3 Terminal Arrangement

A6KV-102RS  
 A6KV-162RS

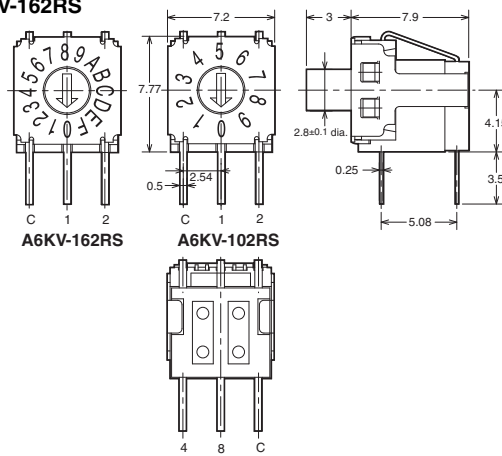

### Top-actuated Flat Models with 5x2 Terminal Arrangement

A6K-104RF  
 A6K-164RF



### Top-actuated Extended shaft Models with 5x2 Terminal Arrangement

A6K-104RS  
 A6K-164RS

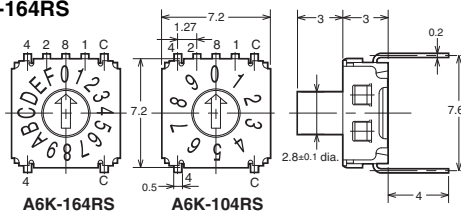

### Side-actuated Flat Models with 5x2 Terminal Arrangement

A6KV-104RF  
 A6KV-164RF

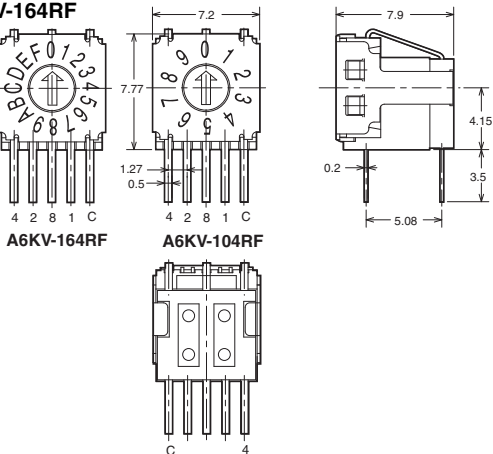

### Side-actuated Extended-shaft Models with 5x2 Terminal Arrangement

A6KV-104RS  
 A6KV-164RS

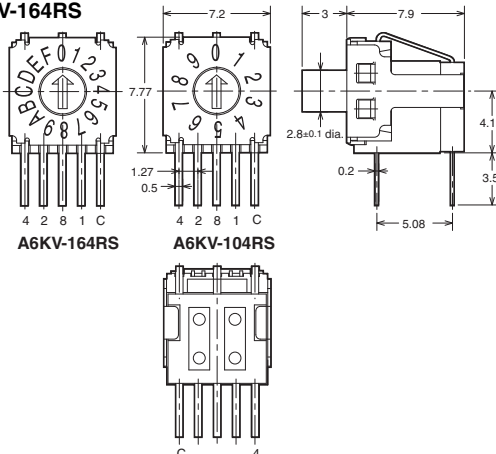

**■ SMT type**

**Top-actuated Flat Models with 3x3 Terminal Arrangement**

**A6KS-102RF**  
**A6KS-162RF**

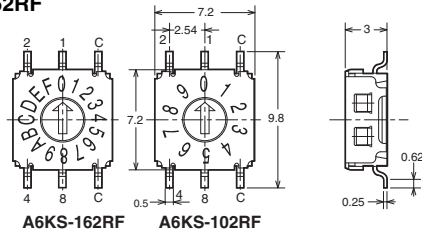

**Top-actuated Extended shaft Models with 3x3 Terminal Arrangement**

**A6KS-102RS**  
**A6KS-162RS**

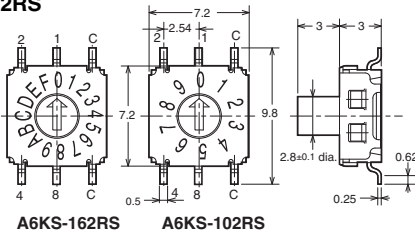

**Top-actuated Flat Models With 5x2 Terminal Arrangement**

**A6KS-104RF**  
**A6KS-164RF**

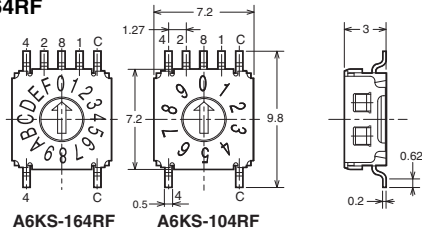

**Top-actuated Extended shaft Models with 5x2 Terminal Arrangement**

**A6KS-104RS**  
**A6KS-164RS**

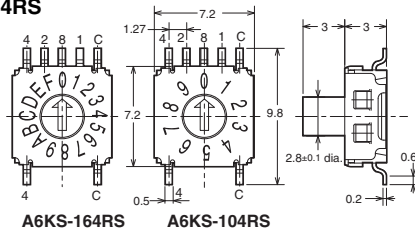

**Side-actuated Flat Models with 5x2 Terminal Arrangement**

**A6KSV-104RF**  
**A6KSV-164RF**

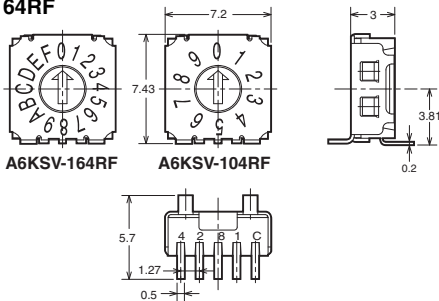

**Side-actuated Extended-shaft Models with 5x2 Terminal Arrangement**

**A6KSV-104RS**  
**A6KSV-164RS**

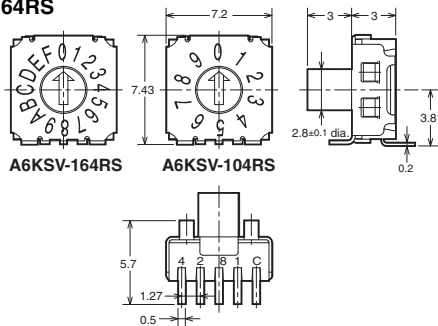

**■ Internal Connections**

**Top-actuated**

**3x3 Terminal Arrangement**    **5x2 Terminal Arrangement**

Through hole type and SMT type    Through hole type and SMT type

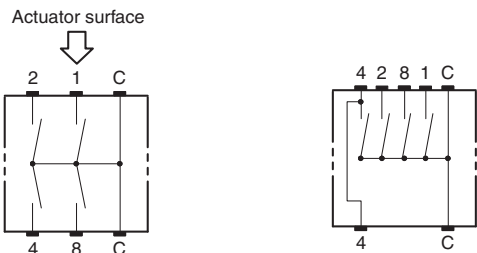

**Side-actuated**

**5x2 Terminal Arrangement**    **5x2 Terminal Arrangement**

Through hole type    SMT type

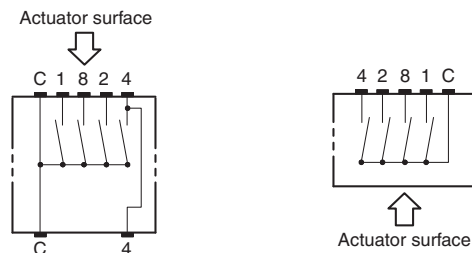

**Note:** 3x3 internal diagram applies to both top and side actuated models

## ■ PCB Cutout Dimensions (Top View)

### 3x3 Terminal Arrangement

**Through hole  
(Top-actuated Models)**

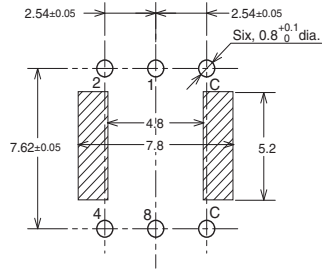

**Through hole  
(Side-actuated Models)**

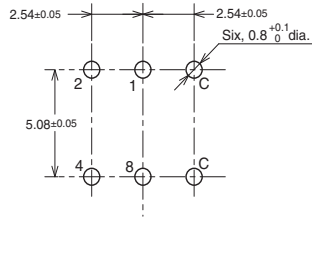

**SMT  
(Top-actuated Models)**

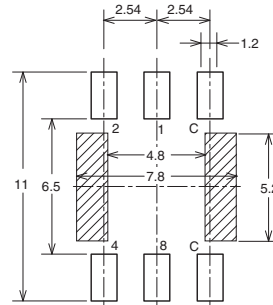

### 5x2 Terminal Arrangement

**Through hole  
(Top-actuated Models)**

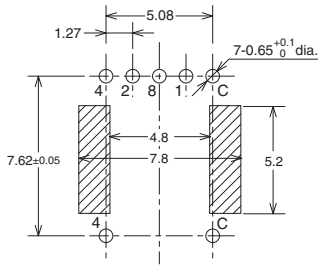

**Through hole  
(Side-actuated Models)**

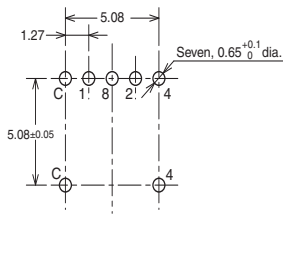

**SMT  
(Top-actuated Models)**

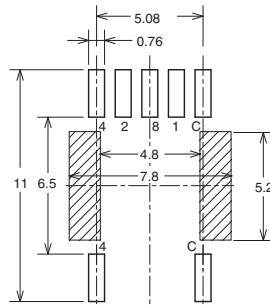

**SMT  
(Side-actuated Models)**

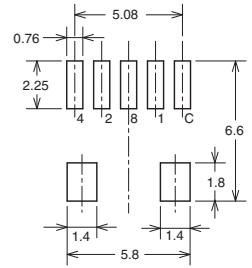

 Through hole: Pattern prohibited area

All sales are subject to Omron Electronic Components LLC standard terms and conditions of sale, which can be found at [http://www.components.omron.com/components/web/webfiles.nsf/sales\\_terms.html](http://www.components.omron.com/components/web/webfiles.nsf/sales_terms.html)

**ALL DIMENSIONS SHOWN ARE IN MILLIMETERS.**  
To convert millimeters into inches, multiply by 0.03937. To convert grams into ounces, multiply by 0.03527.

---

**OMRON**<sup>®</sup>

**OMRON ELECTRONIC  
COMPONENTS LLC**

55 E. Commerce Drive, Suite B  
Schaumburg, IL 60173

**847-882-2288**

**OMRON ON-LINE**

Global - <http://www.omron.com>  
USA - <http://www.components.omron.com>

Компания «Океан Электроники» предлагает заключение долгосрочных отношений при поставках импортных электронных компонентов на взаимовыгодных условиях!

Наши преимущества:

- Поставка оригинальных импортных электронных компонентов напрямую с производств Америки, Европы и Азии, а так же с крупнейших складов мира;
- Широкая линейка поставок активных и пассивных импортных электронных компонентов (более 30 млн. наименований);
- Поставка сложных, дефицитных, либо снятых с производства позиций;
- Оперативные сроки поставки под заказ (от 5 рабочих дней);
- Экспресс доставка в любую точку России;
- Помощь Конструкторского Отдела и консультации квалифицированных инженеров;
- Техническая поддержка проекта, помощь в подборе аналогов, поставка прототипов;
- Поставка электронных компонентов под контролем ВП;
- Система менеджмента качества сертифицирована по Международному стандарту ISO 9001;
- При необходимости вся продукция военного и аэрокосмического назначения проходит испытания и сертификацию в лаборатории (по согласованию с заказчиком);
- Поставка специализированных компонентов военного и аэрокосмического уровня качества (Xilinx, Altera, Analog Devices, Intersil, Interpoint, Microsemi, Actel, Aeroflex, Peregrine, VPT, Syfer, Eurofarad, Texas Instruments, MS Kennedy, Miteq, Cobham, E2V, MA-COM, Hittite, Mini-Circuits, General Dynamics и др.);

Компания «Океан Электроники» является официальным дистрибьютором и эксклюзивным представителем в России одного из крупнейших производителей разъемов военного и аэрокосмического назначения «JONHON», а так же официальным дистрибьютором и эксклюзивным представителем в России производителя высокотехнологичных и надежных решений для передачи СВЧ сигналов «FORSTAR».



## JONHON

«JONHON» (основан в 1970 г.)

Разъемы специального, военного и аэрокосмического назначения:

(Применяются в военной, авиационной, аэрокосмической, морской, железнодорожной, горно- и нефтедобывающей отраслях промышленности)

«FORSTAR» (основан в 1998 г.)

ВЧ соединители, коаксиальные кабели, кабельные сборки и микроволновые компоненты:

(Применяются в телекоммуникациях гражданского и специального назначения, в средствах связи, РЛС, а так же военной, авиационной и аэрокосмической отраслях промышленности).



Телефон: 8 (812) 309-75-97 (многоканальный)

Факс: 8 (812) 320-03-32

Электронная почта: [ocean@oceanchips.ru](mailto:ocean@oceanchips.ru)

Web: <http://oceanchips.ru/>

Адрес: 198099, г. Санкт-Петербург, ул. Калинина, д. 2, корп. 4, лит. А