

Miniature Rotary DIP Switch A6K/A6KS

Miniature (7.2 × 7.2mm size) Rotary DIP Switch

- Mounting space reduced by 50%.
(compared with conventional models)
- SMT and through hole type Available.
Side-actuated type available.
- Gold-plated contacts ensure high reliability.
- RoHS Compliant



NEW

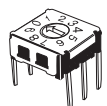
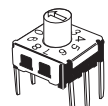
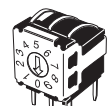
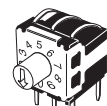

Ordering Information

■ Through hole type

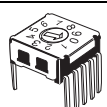
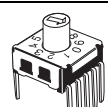
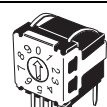
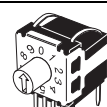
3 × 3 Terminal, tube packaging			Top-actuated flat	Top-actuated extended shaft	Side-actuated flat	Side-actuated extended shaft
Output code	No. of positions	Quantity per tube				
BCD 1-2-4-8	10	Top: 63 Side: 60	A6K-102RF	A6K-102RS	A6KV-102RF	A6KV-102RS
BCD Hexadecimal 1-2-4-8	16		A6K-162RF	A6K-162RS	A6KV-162RF	A6KV-162RS



5 × 2 Terminal, tube packaging			Top-actuated flat	Top-actuated extended shaft	Side-actuated flat	Side-actuated extended shaft
Output code	No. of positions	Quantity per tube				
BCD 1-2-4-8	10	Top: 63 Side: 60	A6K-104RF	A6K-104RS	A6KV-104RF	A6KV-104RS
BCD Hexadecimal 1-2-4-8	16		A6K-164RF	A6K-164RS	A6KV-164RF	A6KV-164RS

■ SMT type

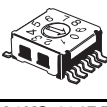
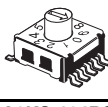
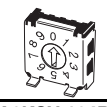
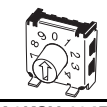
3 × 3 Terminal, tube packaging			Top-actuated flat	Top-actuated extended shaft
Output code	No. of positions	Quantity per tube		
BCD 1-2-4-8	10	63	A6KS-102RF	A6KS-102RS
BCD Hexadecimal 1-2-4-8	16		A6KS-162RF	A6KS-162RS

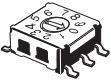
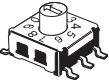
5 × 2 Terminal, tube packaging			Top-actuated flat	Top-actuated extended shaft	Side-actuated flat	Side-actuated extended shaft
Output code	No. of positions	Quantity per tube				
BCD 1-2-4-8	10	63	A6KS-104RF	A6KS-104RS	A6KSV-104RF	A6KSV-104RS
BCD Hexadecimal 1-2-4-8	16		A6KS-164RF	A6KS-164RS	A6KSV-164RF	A6KSV-164RS

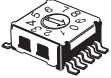
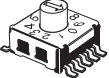
3 × 3 Terminal Embossed Taping Packages		Top-actuated flat		Top-actuated extended shaft	
Output code	No. of positions	Quantity per reel		Quantity per reel	
BCD 1-2-4-8	10	1450	A6KS-102RF-P	850	A6KS-102RS-P
BCD Hexadecimal 1-2-4-8	16		A6KS-162RF-P		A6KS-162RS-P

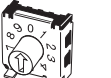
5 × 2 Terminal Embossed Taping Packages		Top-actuated flat		Top-actuated extended shaft		Side-actuated flat		Side-actuated extended shaft	
Output code	No. of positions	Quantity per reel		Quantity per reel		Quantity per reel		Quantity per reel	
BCD 1-2-4-8	10	1450	A6KS-104RF-P	850	A6KS-104RS-P	750	A6KSV-104RF-P	750	A6KSV-104RS-P
BCD Hexadecimal 1-2-4-8	16		A6KS-164RF-P		A6KS-164RS-P		A6KSV-164RF-P		A6KSV-164RS-P

Specifications

Characteristics

Switching capacity	25 mA at 24 VDC	
Minimum permissible load	10 μA at 3.5 VDC	
Contact resistance	200 mΩ max.	
Insulation resistance	100 MΩ min. (at 250 VDC)	
Dielectric strength	250 VAC for 1 min between terminals	
Operating torque	200 g·cm max. (1.96 × 10 ⁻² N·m max.)	
Vibration resistance	Malfunction durability	10 to 55 Hz, 1.5-mm double amplitude
Shock resistance	Malfunction durability	300 m/s ² min.
Ambient operating temperature	-30 to 80°C at 60% max. (with no icing or condensation)	
Ambient operating humidity	35% to 95% (at 5 to 35°C)	
Electrical service life	20,000 steps min.	
Weight (See note 2.)	Through hole terminal	Top-actuated, flat: Approx. 0.4 g, Side-actuated, flat: Approx. 0.7 g
	SMT terminal	Top-actuated, flat: Approx. 0.4 g, Side-actuated, flat: Approx. 0.4 g

Note: 1. Data shown are of initial value.
2. Add 0.03 g for the extended-shaft version of each model.

Output Codes

10-position Models

Type	BCD 1-2-4-8				
	Terminal No. Position	1	2	4	8
0					
1	●				
2		●			
3	●	●			
4			●		
5	●		●		
6		●	●		
7	●	●	●		
8					●
9	●				●

16-position Models

Type	BCD/hexadecimal 1-2-4-8				
	Terminal No. Position	1	2	4	8
0					
1	●				
2		●			
3	●	●			
4			●		
5	●		●		
6		●	●		
7	●	●	●		
8					●
9	●				●
A		●			●
B	●	●			●
C			●		●
D	●		●		●
E		●	●		●
F	●	●	●		●

Note: "●" indicates that the internal switch is ON.

Dimensions

Note: 1. All units are in millimeters unless otherwise indicated.
 2. Unless otherwise specified, a tolerance of ± 0.4 mm applies to all dimensions.

Through hole type

Top-actuated Flat Models with 3x3 Terminal Arrangement

A6K-102RF
 A6K-162RF



Top-actuated Extended shaft Models with 3x3 Terminal Arrangement

A6K-102RS
 A6K-162RS



Side-actuated Flat Models with 3x3 Terminal Arrangement

A6KV-102RF
 A6KV-162RF



Side-actuated Extended-shaft Models with 3x3 Terminal Arrangement

A6KV-102RS
 A6KV-162RS



Top-actuated Flat Models with 5x2 Terminal Arrangement

A6K-104RF
 A6K-164RF



Top-actuated Extended shaft Models with 5x2 Terminal Arrangement

A6K-104RS
 A6K-164RS



Side-actuated Flat Models with 5x2 Terminal Arrangement

A6KV-104RF
 A6KV-164RF



Side-actuated Extended-shaft Models with 5x2 Terminal Arrangement

A6KV-104RS
 A6KV-164RS

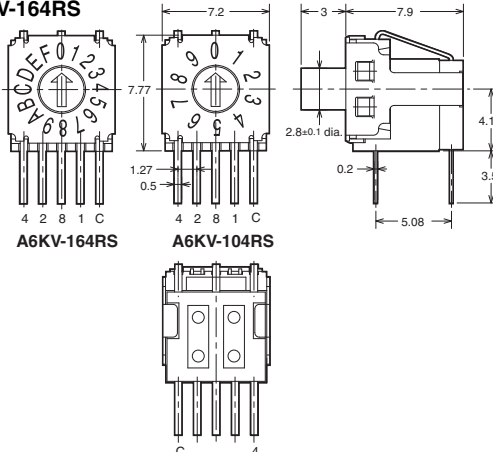

■ SMT type

Top-actuated Flat Models with 3x3 Terminal Arrangement

A6KS-102RF
A6KS-162RF

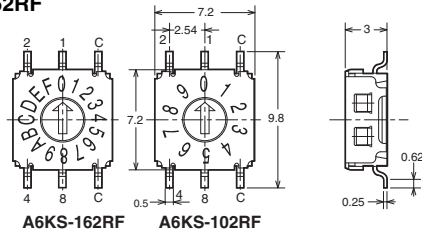

Top-actuated Extended shaft Models with 3x3 Terminal Arrangement

A6KS-102RS
A6KS-162RS

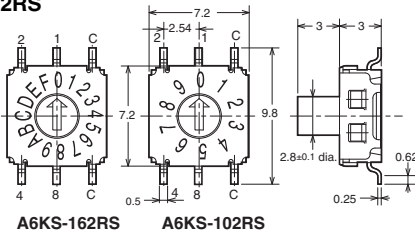

Top-actuated Flat Models With 5x2 Terminal Arrangement

A6KS-104RF
A6KS-164RF

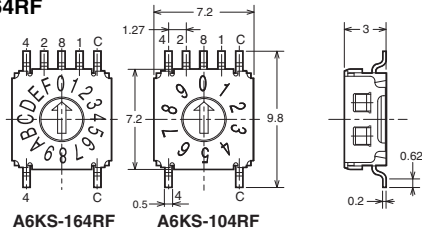

Top-actuated Extended shaft Models with 5x2 Terminal Arrangement

A6KS-104RS
A6KS-164RS

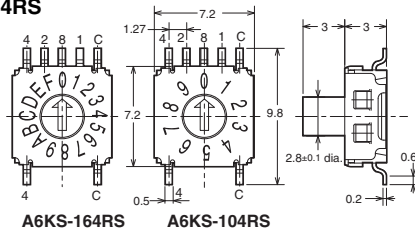

Side-actuated Flat Models with 5x2 Terminal Arrangement

A6KSV-104RF
A6KSV-164RF

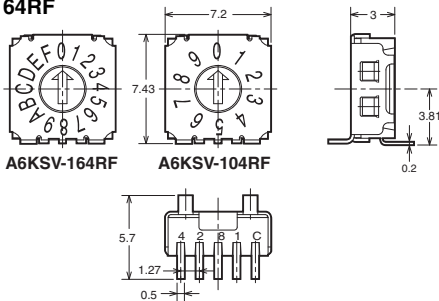

Side-actuated Extended-shaft Models with 5x2 Terminal Arrangement

A6KSV-104RS
A6KSV-164RS

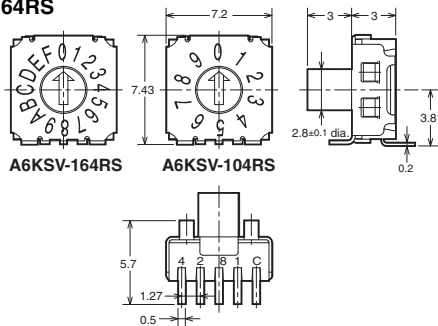

■ Internal Connections

Top-actuated

3x3 Terminal Arrangement 5x2 Terminal Arrangement

Through hole type and SMT type Through hole type and SMT type

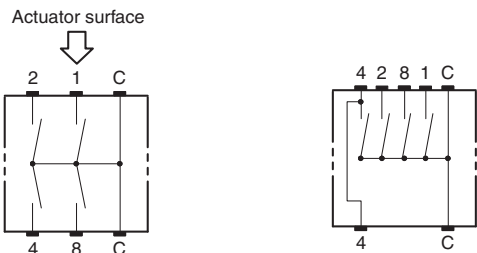

Side-actuated

5x2 Terminal Arrangement 5x2 Terminal Arrangement

Through hole type SMT type

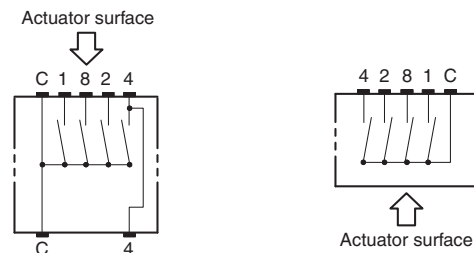

Note: 3x3 internal diagram applies to both top and side actuated models

PCB Cutout Dimensions (Top View)

3x3 Terminal Arrangement

**Through hole
(Top-actuated Models)**



**Through hole
(Side-actuated Models)**



**SMT
(Top-actuated Models)**



5x2 Terminal Arrangement

**Through hole
(Top-actuated Models)**



**Through hole
(Side-actuated Models)**



**SMT
(Top-actuated Models)**



**SMT
(Side-actuated Models)**



 Through hole: Pattern prohibited area

All sales are subject to Omron Electronic Components LLC standard terms and conditions of sale, which can be found at http://www.components.omron.com/components/web/webfiles.nsf/sales_terms.html

ALL DIMENSIONS SHOWN ARE IN MILLIMETERS.
To convert millimeters into inches, multiply by 0.03937. To convert grams into ounces, multiply by 0.03527.

OMRON[®]

**OMRON ELECTRONIC
COMPONENTS LLC**

55 E. Commerce Drive, Suite B
Schaumburg, IL 60173

847-882-2288

OMRON ON-LINE

Global - <http://www.omron.com>

USA - <http://www.components.omron.com>

Компания «Океан Электроники» предлагает заключение долгосрочных отношений при поставках импортных электронных компонентов на взаимовыгодных условиях!

Наши преимущества:

- Поставка оригинальных импортных электронных компонентов напрямую с производств Америки, Европы и Азии, а так же с крупнейших складов мира;
- Широкая линейка поставок активных и пассивных импортных электронных компонентов (более 30 млн. наименований);
- Поставка сложных, дефицитных, либо снятых с производства позиций;
- Оперативные сроки поставки под заказ (от 5 рабочих дней);
- Экспресс доставка в любую точку России;
- Помощь Конструкторского Отдела и консультации квалифицированных инженеров;
- Техническая поддержка проекта, помощь в подборе аналогов, поставка прототипов;
- Поставка электронных компонентов под контролем ВП;
- Система менеджмента качества сертифицирована по Международному стандарту ISO 9001;
- При необходимости вся продукция военного и аэрокосмического назначения проходит испытания и сертификацию в лаборатории (по согласованию с заказчиком);
- Поставка специализированных компонентов военного и аэрокосмического уровня качества (Xilinx, Altera, Analog Devices, Intersil, Interpoint, Microsemi, Actel, Aeroflex, Peregrine, VPT, Syfer, Eurofarad, Texas Instruments, MS Kennedy, Miteq, Cobham, E2V, MA-COM, Hittite, Mini-Circuits, General Dynamics и др.);

Компания «Океан Электроники» является официальным дистрибьютором и эксклюзивным представителем в России одного из крупнейших производителей разъемов военного и аэрокосмического назначения «JONHON», а так же официальным дистрибьютором и эксклюзивным представителем в России производителя высокотехнологичных и надежных решений для передачи СВЧ сигналов «FORSTAR».



JONHON

«JONHON» (основан в 1970 г.)

Разъемы специального, военного и аэрокосмического назначения:

(Применяются в военной, авиационной, аэрокосмической, морской, железнодорожной, горно- и нефтедобывающей отраслях промышленности)

«FORSTAR» (основан в 1998 г.)

ВЧ соединители, коаксиальные кабели, кабельные сборки и микроволновые компоненты:

(Применяются в телекоммуникациях гражданского и специального назначения, в средствах связи, РЛС, а так же военной, авиационной и аэрокосмической отраслях промышленности).



Телефон: 8 (812) 309-75-97 (многоканальный)

Факс: 8 (812) 320-03-32

Электронная почта: ocean@oceanchips.ru

Web: <http://oceanchips.ru/>

Адрес: 198099, г. Санкт-Петербург, ул. Калинина, д. 2, корп. 4, лит. А