



**Hittite**  
MICROWAVE PRODUCTS  
FROM ANALOG DEVICES

# Analog Devices Welcomes Hittite Microwave Corporation



**THIS PAGE INTENTIONALLY LEFT BLANK**

### Typical Applications

Prescaler for DC to C band PLL applications:

- UNII, point-to-point, and VSAT radios
- 802.11a and HiperLAN WLAN
- Fiber optic
- Cellular / 3G infrastructure

### Features

- Ultra low SSB phase noise: -148 dBc/Hz
- Single-ended I/O's
- Output power: -3 dBm to -9 dBm
- Single DC supply: +3V @ 42 mA
- 9 mm<sup>2</sup> ultra small package: SOT26

### Functional Diagram

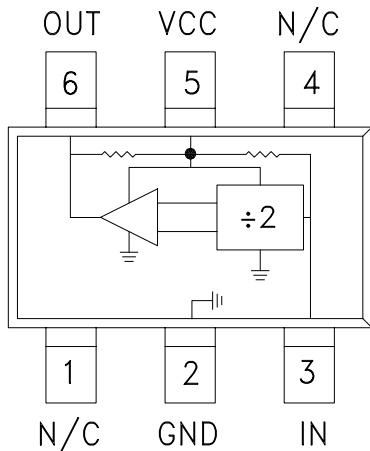

### General Description

The HMC432(E) is a low noise divide-by-2 static divider utilizing InGaP GaAs HBT technology in ultra small surface mount SOT26 plastic packages. This device operates from DC (with a square wave input) to 8 GHz input frequency with a single +3V DC supply. Single-ended inputs and outputs reduce component count and cost. The low additive SSB phase noise of -148 dBc/Hz at 100 kHz offset helps the user maintain good system noise performance.

### Electrical Specifications, $T_A = +25^\circ\text{C}$ , 50 $\Omega$ System, $V_{CC} = +3\text{V}$

Parameter	Conditions	Min.	Typ.	Max.	Units
Input frequency	Sine wave input [1] [2]			8	GHz
Input power range	$F_{in} = 0.2 \text{ GHz to } 0.4 \text{ GHz}$	-4		+11	dBm
	$F_{in} = 0.4 \text{ GHz to } 0.6 \text{ GHz}$	-10		+12	
	$F_{in} = 0.6 \text{ GHz to } 1.0 \text{ GHz}$	-15		+15	
	$F_{in} = 1 \text{ GHz to } 7 \text{ GHz}$	-12		+12	
	$F_{in} = 7 \text{ GHz to } 8 \text{ GHz}$	-4		+10	
Output power	$F_{in} = 4 \text{ GHz}$	-6	-3		dBm
	$F_{in} = 8 \text{ GHz}$	-12	-9		dBm
Reverse leakage	RF output terminated, $F_{in} = 4 \text{ GHz}$ , $P_{in} = 0 \text{ dBm}$		-30		dBm
SSB phase noise (100 kHz offset)	$P_{in} = 0 \text{ dBm}$ , $F_{in} = 4 \text{ GHz}$		-148		dBc/Hz
Output transition time	$P_{in} = 0 \text{ dBm}$ , $F_{out} = 882 \text{ MHz}$		145		ps
Supply current ( $I_{CC}$ )	$V_{CC} = 3.0 \text{ V}$		42	56	mA

1. Divider will operate down to near DC.

2. For stable operation without an input signal, refer to Analog Devices Application Note, "Frequency Divider Operation & Compensation with No Input Signal."



**SMT GaAs HBT MMIC  
DIVIDE-BY-2, DC - 8 GHz**

**Input Sensitivity Window, T = 25 °C**

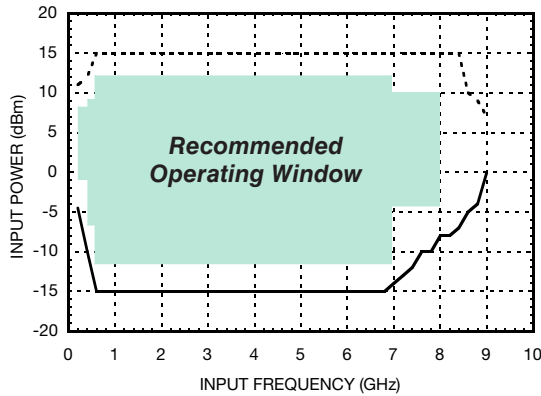

**Input Sensitivity Window vs. Temperature**

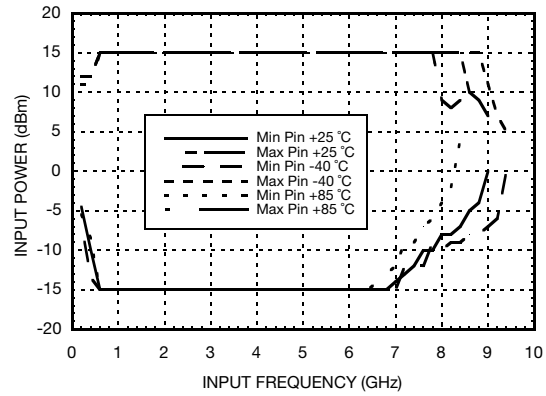

**Output Power vs. Temperature**

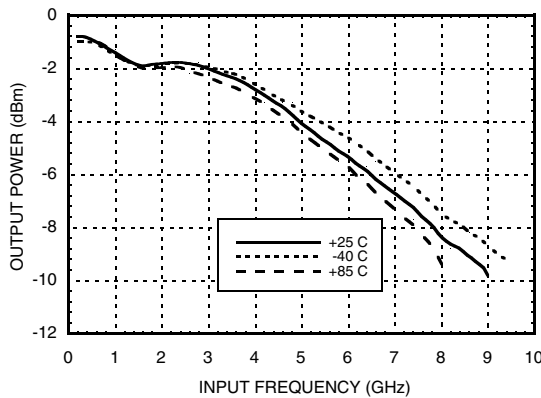

**SSB Phase Noise Performance,  
Pin = 0 dBm, T = 25 °C**

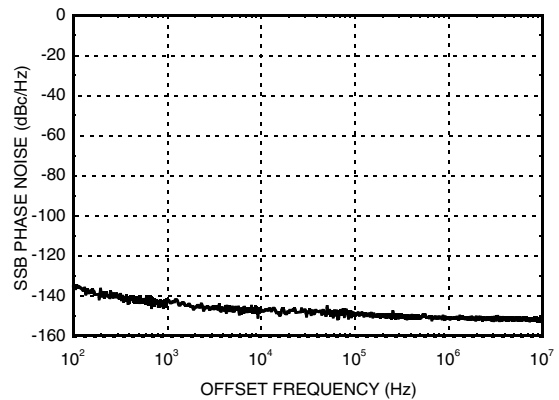

**Output Harmonic Content,  
Pin = 0 dBm, T = 25 °C**

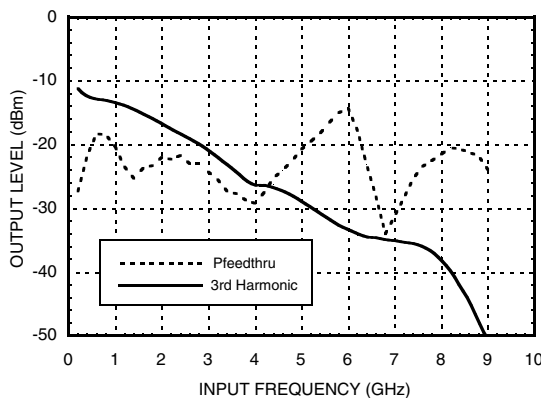

**Reverse Leakage, Pin = 0 dBm, T = 25 °C**

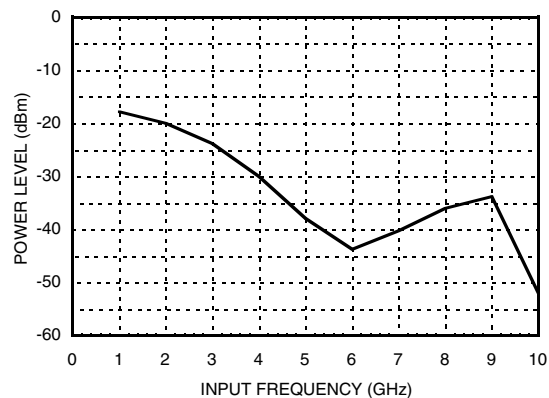



**Output Voltage Waveform,**  
*Pin = 0 dBm, Fout = 882 MHz, T = 25 °C*

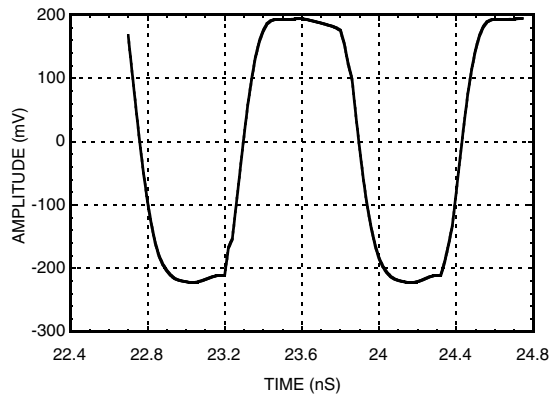

**Absolute Maximum Ratings**

RF input power (Vcc = +3V)	15 dBm
Nominal +3V supply to GND	-0.3V to 3.5V
Max peak flow temperature	260 °C
Storage temperature	-65 °C to +125 °C
ESD sensitivity (HBM)	150 V

**Reliability Information**

Junction temperature to maintain 1 million hour MTTF	135 °C
Nominal junction temperature (T = 85 °C)	99 °C
Thermal resistance (Junction to GND paddle, 3V supply)	108 °C/W
Operating temperature	-40 to +85 °C

DC blocking capacitors are required at RF input and RF output ports. Choose value for lowest frequency of operation.

**Typical Supply Current vs. Vcc**

Vcc (V)	Icc (mA)
2.70	34
3.00	42
3.30	50

Note: Divider will operate over full voltage range shown above



**ELECTROSTATIC SENSITIVE DEVICE  
OBSERVE HANDLING PRECAUTIONS**



### Outline Drawing

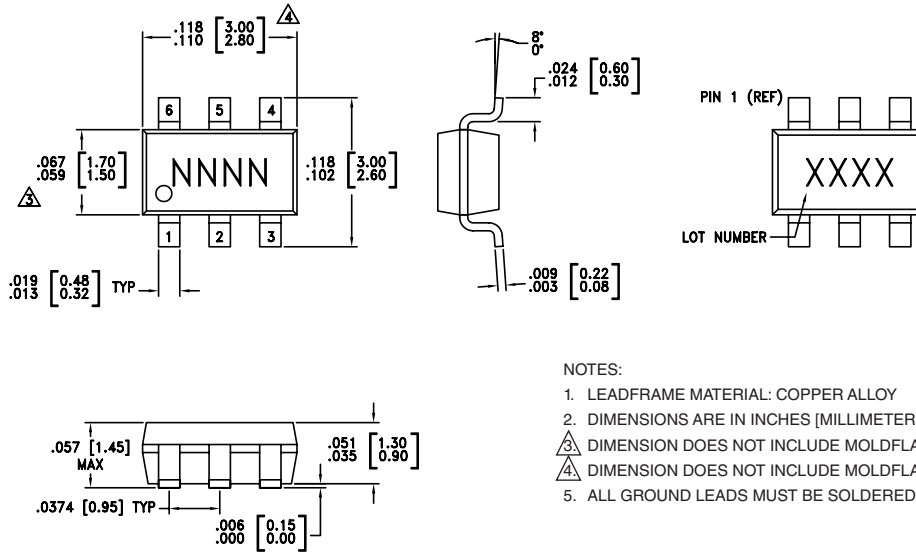

NOTES:

1. LEADFRAME MATERIAL: COPPER ALLOY
2. DIMENSIONS ARE IN INCHES [MILLIMETERS].
3. DIMENSION DOES NOT INCLUDE MOLDFLASH OF 0.15 mm PER SIDE.
4. DIMENSION DOES NOT INCLUDE MOLDFLASH OF 0.25 mm PER SIDE.
5. ALL GROUND LEADS MUST BE SOLDERED TO PCB RF GROUND.

### Package Information

Part Number	Package Body Material	Lead Finish	MSL Rating	Package Marking <sup>[3]</sup>
HMC432	Low stress injection molded plastic	Sn/Pb solder	MSL1 <sup>[1]</sup>	H432 XXXX
HMC432E	RoHS-compliant low stress injection molded plastic	100% matte Sn	MSL1 <sup>[2]</sup>	432E XXXX

- [1] Max peak reflow temperature of 235 °C  
 [2] Max peak reflow temperature of 260 °C  
 [3] 4-digit lot number XXXX

### Pin Description

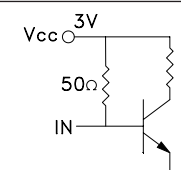
Pin Number	Function	Description	Interface Schematic
1, 4	N/C	The pins are not connected internally; however, all data shown herein was measured with these pins connected to RF/DC ground externally.	
2	GND	Pin must connect to RF/DC ground.	
3	IN	RF input must be DC blocked.	

### Pin Description (Continued)

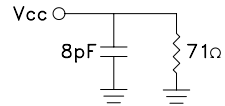
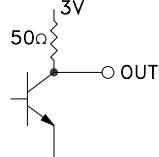
Pin Number	Function	Description	Interface Schematic
5	Vcc	Supply voltage 3V ±0.3V.	
6	OUT	Divided output must be DC blocked.	

### Application Circuit

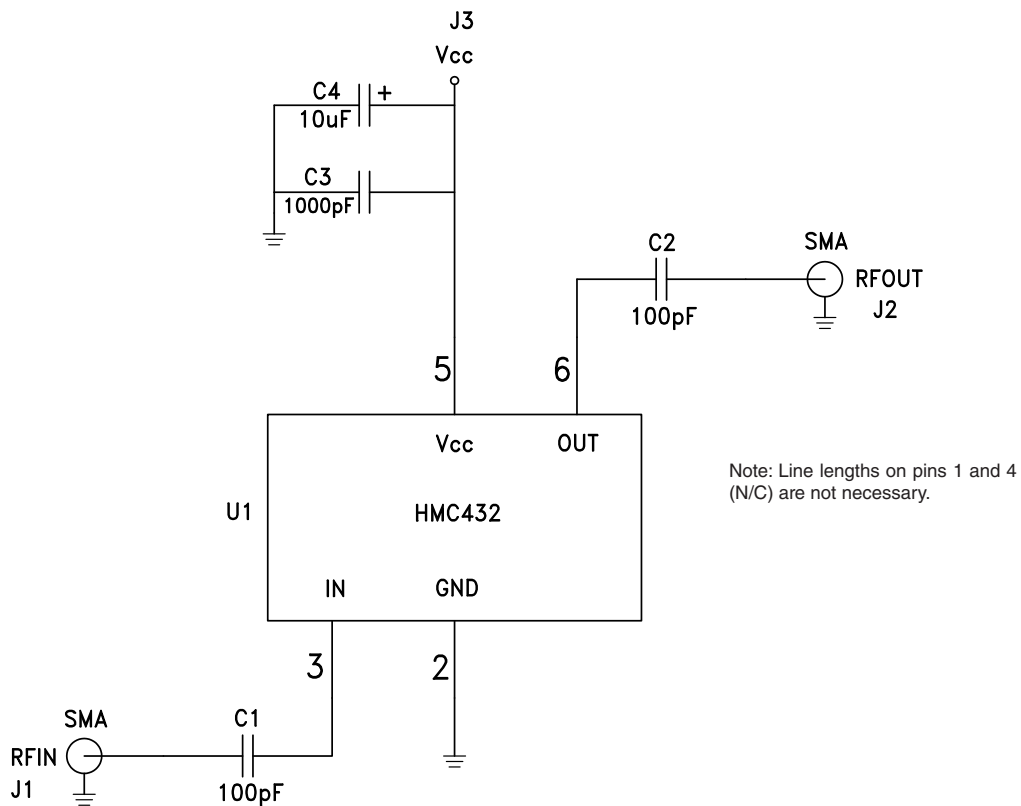

Note:

DC blocking capacitor values (C1, C2) and DC decoupling capacitor values (C3, C4) are chosen for lowest frequency of operation.

**Evaluation PCB**

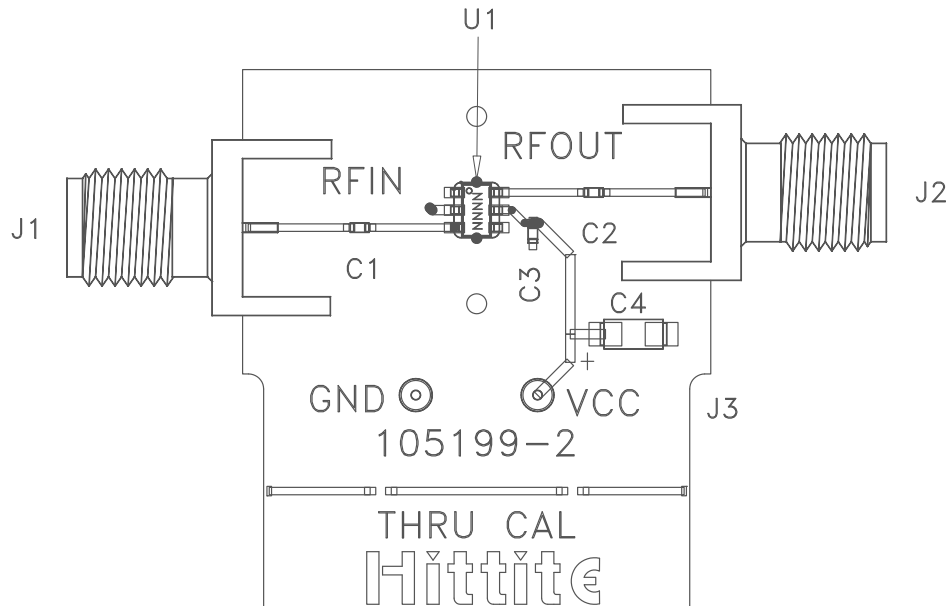

**List of Materials for Evaluation PCB 105675 [1]**

Item	Description
J1 - J2	PCB mount SMA RF connector
J3 - J4	DC pin
C1 - C2	100 pF capacitor, 0402 pkg.
C3	1000 pF capacitor, 0402 pkg.
C4	10 μF tantalum capacitor, 1206 pkg.
U1	HMC432/HMC432E divide-by-2
PCB [2]	105199 eval board

[1] Reference this number when ordering complete evaluation PCB

[2] Circuit board material: Rogers 4350

The circuit board used in the application should use RF circuit design techniques. Signal lines should have 50 Ω impedance while the package ground leads should be connected directly to the ground plane similar to that shown. A sufficient number of via holes should be used to connect the top and bottom ground planes. The evaluation circuit board shown is available from Hittite upon request.



Компания «Океан Электроники» предлагает заключение долгосрочных отношений при поставках импортных электронных компонентов на взаимовыгодных условиях!

Наши преимущества:

- Поставка оригинальных импортных электронных компонентов напрямую с производств Америки, Европы и Азии, а так же с крупнейших складов мира;
- Широкая линейка поставок активных и пассивных импортных электронных компонентов (более 30 млн. наименований);
- Поставка сложных, дефицитных, либо снятых с производства позиций;
- Оперативные сроки поставки под заказ (от 5 рабочих дней);
- Экспресс доставка в любую точку России;
- Помощь Конструкторского Отдела и консультации квалифицированных инженеров;
- Техническая поддержка проекта, помощь в подборе аналогов, поставка прототипов;
- Поставка электронных компонентов под контролем ВП;
- Система менеджмента качества сертифицирована по Международному стандарту ISO 9001;
- При необходимости вся продукция военного и аэрокосмического назначения проходит испытания и сертификацию в лаборатории (по согласованию с заказчиком);
- Поставка специализированных компонентов военного и аэрокосмического уровня качества (Xilinx, Altera, Analog Devices, Intersil, Interpoint, Microsemi, Actel, Aeroflex, Peregrine, VPT, Syfer, Eurofarad, Texas Instruments, MS Kennedy, Miteq, Cobham, E2V, MA-COM, Hittite, Mini-Circuits, General Dynamics и др.);

Компания «Океан Электроники» является официальным дистрибьютором и эксклюзивным представителем в России одного из крупнейших производителей разъемов военного и аэрокосмического назначения «JONHON», а так же официальным дистрибьютором и эксклюзивным представителем в России производителя высокотехнологичных и надежных решений для передачи СВЧ сигналов «FORSTAR».



## JONHON

«JONHON» (основан в 1970 г.)

Разъемы специального, военного и аэрокосмического назначения:

(Применяются в военной, авиационной, аэрокосмической, морской, железнодорожной, горно- и нефтедобывающей отраслях промышленности)

«FORSTAR» (основан в 1998 г.)

ВЧ соединители, коаксиальные кабели, кабельные сборки и микроволновые компоненты:

(Применяются в телекоммуникациях гражданского и специального назначения, в средствах связи, РЛС, а так же военной, авиационной и аэрокосмической отраслях промышленности).



Телефон: 8 (812) 309-75-97 (многоканальный)

Факс: 8 (812) 320-03-32

Электронная почта: [ocean@oceanchips.ru](mailto:ocean@oceanchips.ru)

Web: <http://oceanchips.ru/>

Адрес: 198099, г. Санкт-Петербург, ул. Калинина, д. 2, корп. 4, лит. А