

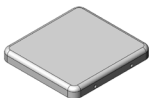



# MS213-10\*

## DRAWN EMI/RFI SHIELD DATA-SHEET

### \*OPTIONAL SHIELD CONFIGURATIONS

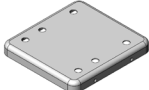
MS SHIELD	MS SET PN.	MS ITEM PN.	DESCRIPTION	RAW MATERIAL
	MS213-10	MS213-10C	TWO-PIECE SHIELD COVER	TIN STEEL*
		MS213-10F	TWO-PIECE SHIELD FRAME	
	MS213-10-NS	MS213-10C-NS	TWO-PIECE SHIELD COVER	NICKEL SILVER**
		MS213-10F-NS	TWO-PIECE SHIELD FRAME	
	MS213-10P	MS213-10CP	TWO-PIECE SHIELD COVER PERFORATED	TIN STEEL*
		MS213-10F	TWO-PIECE SHIELD FRAME	
	MS213-10P-NS	MS213-10CP-NS	TWO-PIECE SHIELD COVER PERFORATED	NICKEL SILVER**
		MS213-10F-NS	TWO-PIECE SHIELD FRAME	
		MS213-10S	ONE-PIECE SHIELD	TIN STEEL*
		MS213-10S-NS	ONE-PIECE SHIELD	NICKEL SILVER**

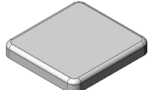
\* TIN-PLATED STEEL: CRS ELECTROLYTIC TINPLATE

\*\* NICKEL SILVER: UNS C77000 / UNS C73500



MS PN:

DESCRIPTION:

MATERIAL:

© MASACH TECH LTD.  
22 HAGANAN, MODIIN 7169513 ISRAEL  
T: (+972) 8-9754681 / F: (+972) 8-9754682  
info@masach.com / www.masach.com

SHIELD TYPE:

**SEAMLESS PROTECTIVE EMI/RFI CAGE**

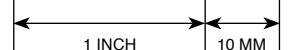

MMGS / PRINT 1:1 / A4

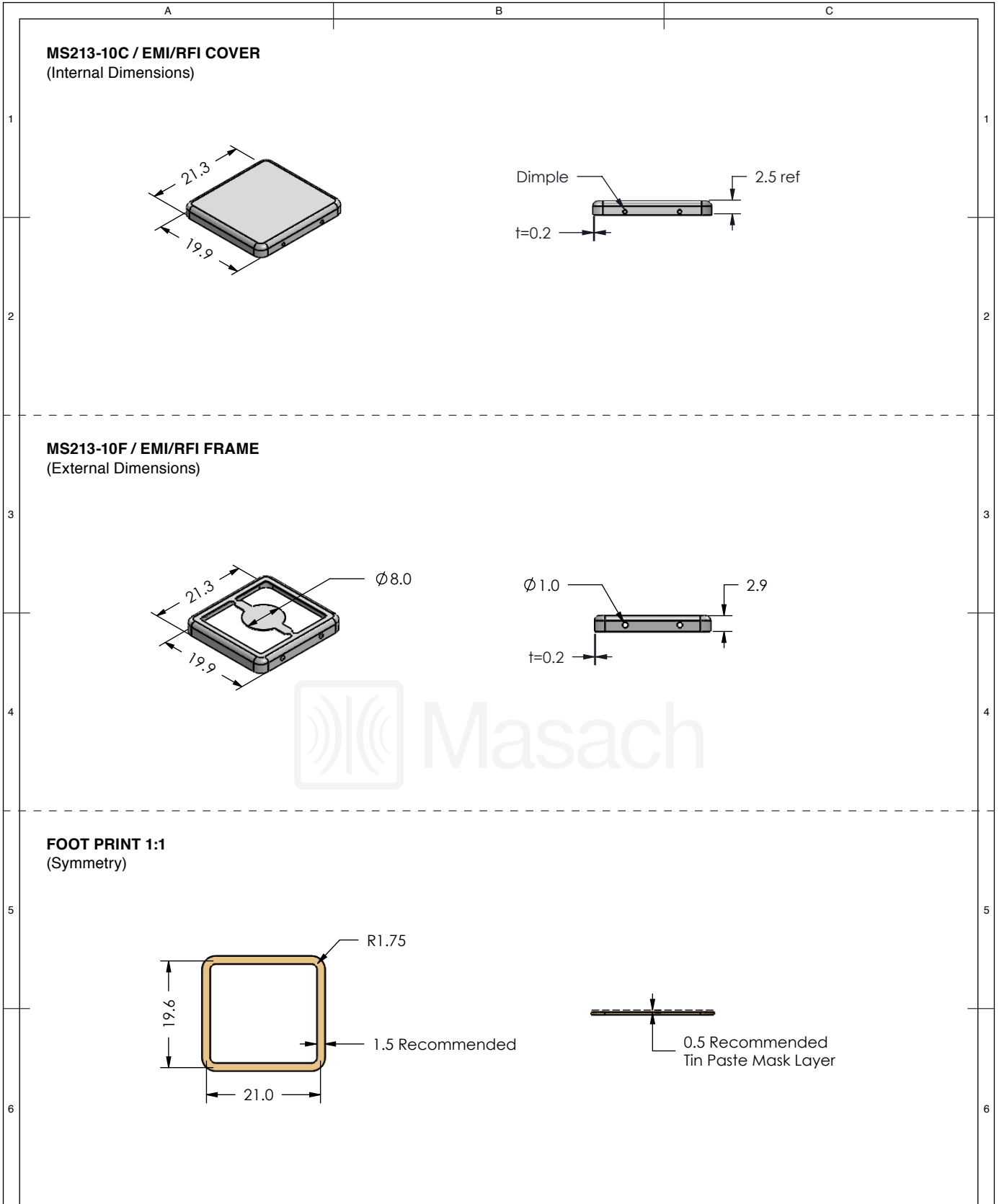

	MS SET PN:	DESCRIPTION:	MATERIAL:
	<b>MS213-10</b>	<b>TWO-PIECE EM/RF SHIELD</b>	<b>TIN PLATED STEEL (1)</b>
<b>NOTE:</b> (1) CRS ELECTROLYTIC TINPLATE (2) GENERAL TOLERANCE (+/-) 0.2MM			
© MASACH TECH LTD. 22 HAGANAN, MODIIN 7169513 ISRAEL T: (+972) 8-9754681 / F: (+972) 8-9754682 <a href="mailto:info@masach.com">info@masach.com</a> / <a href="http://www.masach.com">www.masach.com</a>	SHIELD TYPE:		
	<b>SEAMLESS PROTECTIVE EMI/RFI CAGE</b>		MMGS / PRINT 1:1 / A4

This product has been designed and manufactured by © Masach Tech Ltd. The use of this product in any type of electronic device or application is not under Masach Tech Ltd. liability.

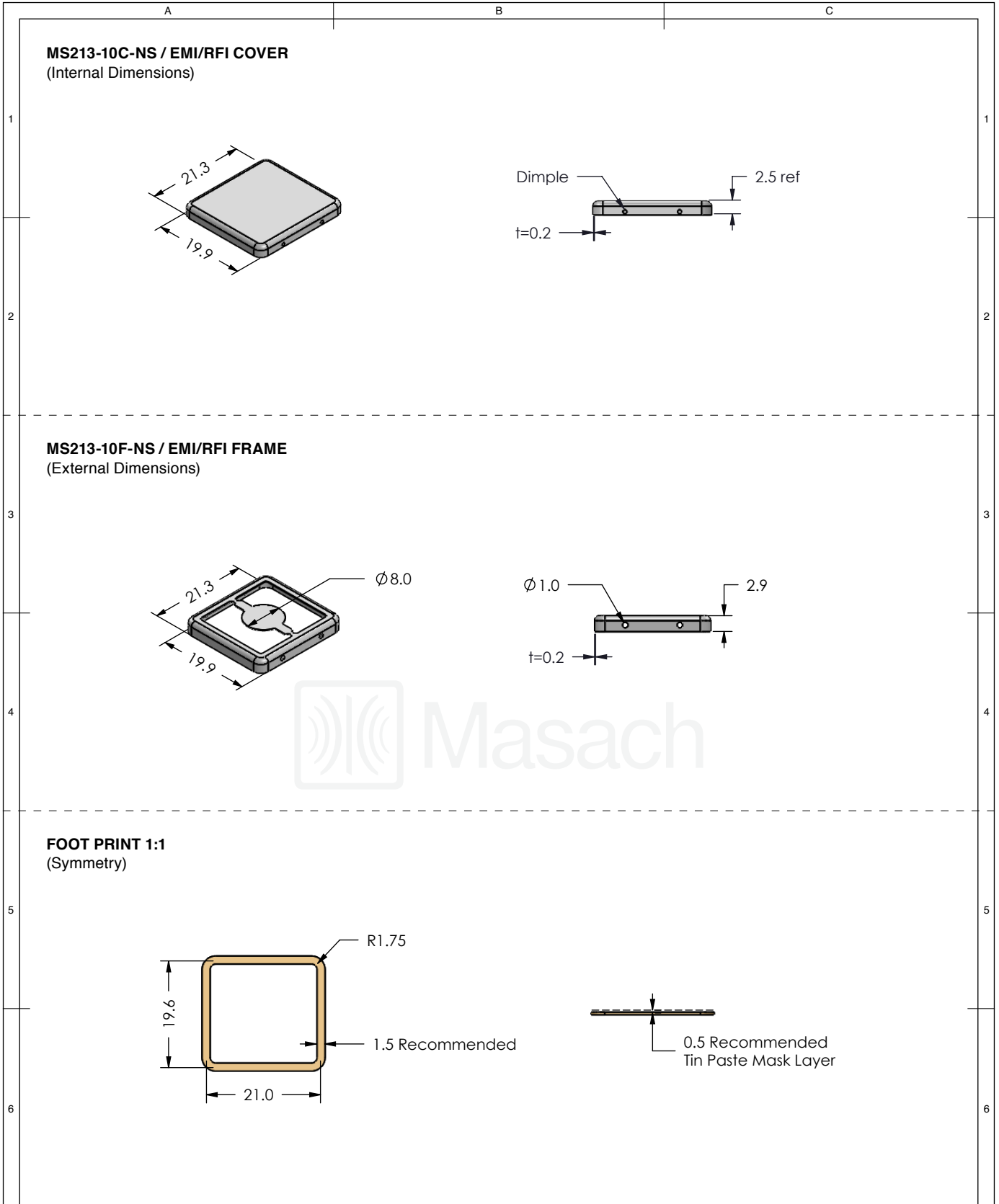

	MS SET PN:	DESCRIPTION:	MATERIAL:
	<b>MS213-10-NS</b>	<b>TWO-PIECE EM/RF SHIELD</b>	<b>NICKEL SILVER (1)</b>
<b>NOTE:</b> (1) UNS C77000 / UNS C73500 (2) GENERAL TOLERANCE (+/-) 0.2MM			
© MASACH TECH LTD. 22 HAGANAN, MODIIN 7169513 ISRAEL T: (+972) 8-9754681 / F: (+972) 8-9754682 <a href="mailto:info@masach.com">info@masach.com</a> / <a href="http://www.masach.com">www.masach.com</a>	SHIELD TYPE:		
	<b>SEAMLESS PROTECTIVE EMI/RFI CAGE</b>		MMGS / PRINT 1:1 / A4

This product has been designed and manufactured by © Masach Tech Ltd. The use of this product in any type of electronic device or application is not under Masach Tech Ltd. liability.

**MS213-10CP / EMI/RFI COVER**  
(Internal Dimensions)

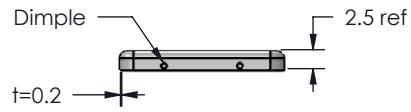
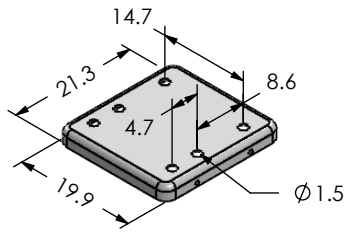

**MS213-10F / EMI/RFI FRAME**  
(External Dimensions)

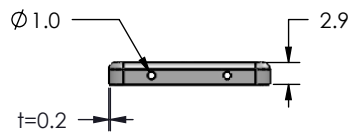
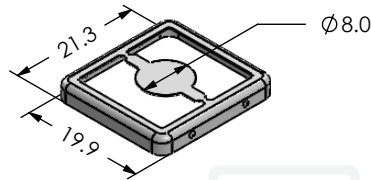

**FOOT PRINT 1:1**  
(Symmetry)

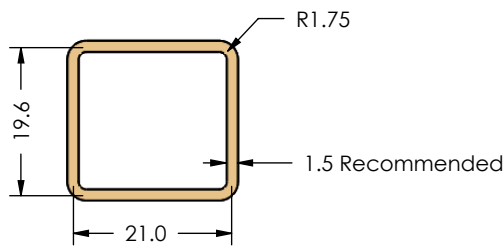

MS SET PN:

DESCRIPTION:

MATERIAL:

**MS213-10P**

**TWO-PIECE EMI/RF SHIELD**

**TIN PLATED STEEL (1)**

**NOTE:** (1) CRS ELECTROLYTIC TINPLATE (2) GENERAL TOLERANCE (+/-) 0.2MM

© MASACH TECH LTD.  
22 HAGANAN, MODIIN 7169513 ISRAEL  
T: (+972) 8-9754681 / F: (+972) 8-9754682  
info@masach.com / www.masach.com

SHIELD TYPE:

**SEAMLESS PROTECTIVE EMI/RFI CAGE**

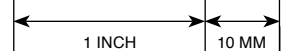

MMGS / PRINT 1:1 / A4

**MS213-10CP-NS / EMI/RFI COVER**  
(Internal Dimensions)

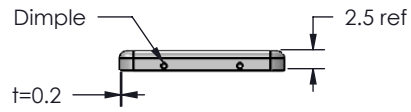
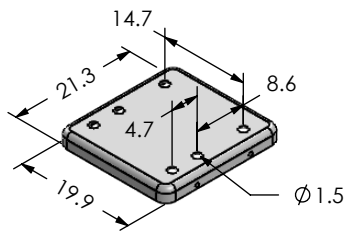

**MS213-10F-NS / EMI/RFI FRAME**  
(External Dimensions)

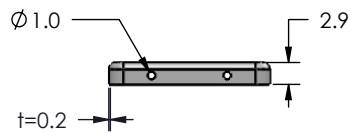
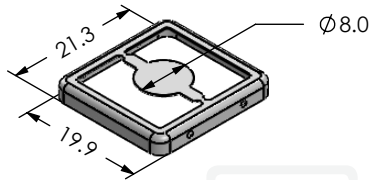

**FOOT PRINT 1:1**  
(Symmetry)

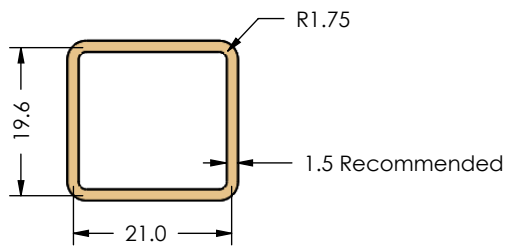

MS SET PN:

DESCRIPTION:

MATERIAL:

**MS213-10P-NS**

**TWO-PIECE EMI/RF SHIELD**

**NICKEL SILVER (1)**

**NOTE:** (1) UNS C77000 / UNS C73500 (2) GENERAL TOLERANCE (+/-) 0.2MM

© MASACH TECH LTD.  
22 HAGANAN, MODIIN 7169513 ISRAEL  
T: (+972) 8-9754681 / F: (+972) 8-9754682  
info@masach.com / www.masach.com

SHIELD TYPE:

**SEAMLESS PROTECTIVE EMI/RFI CAGE**

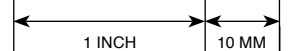

MMGS / PRINT 1:1 / A4

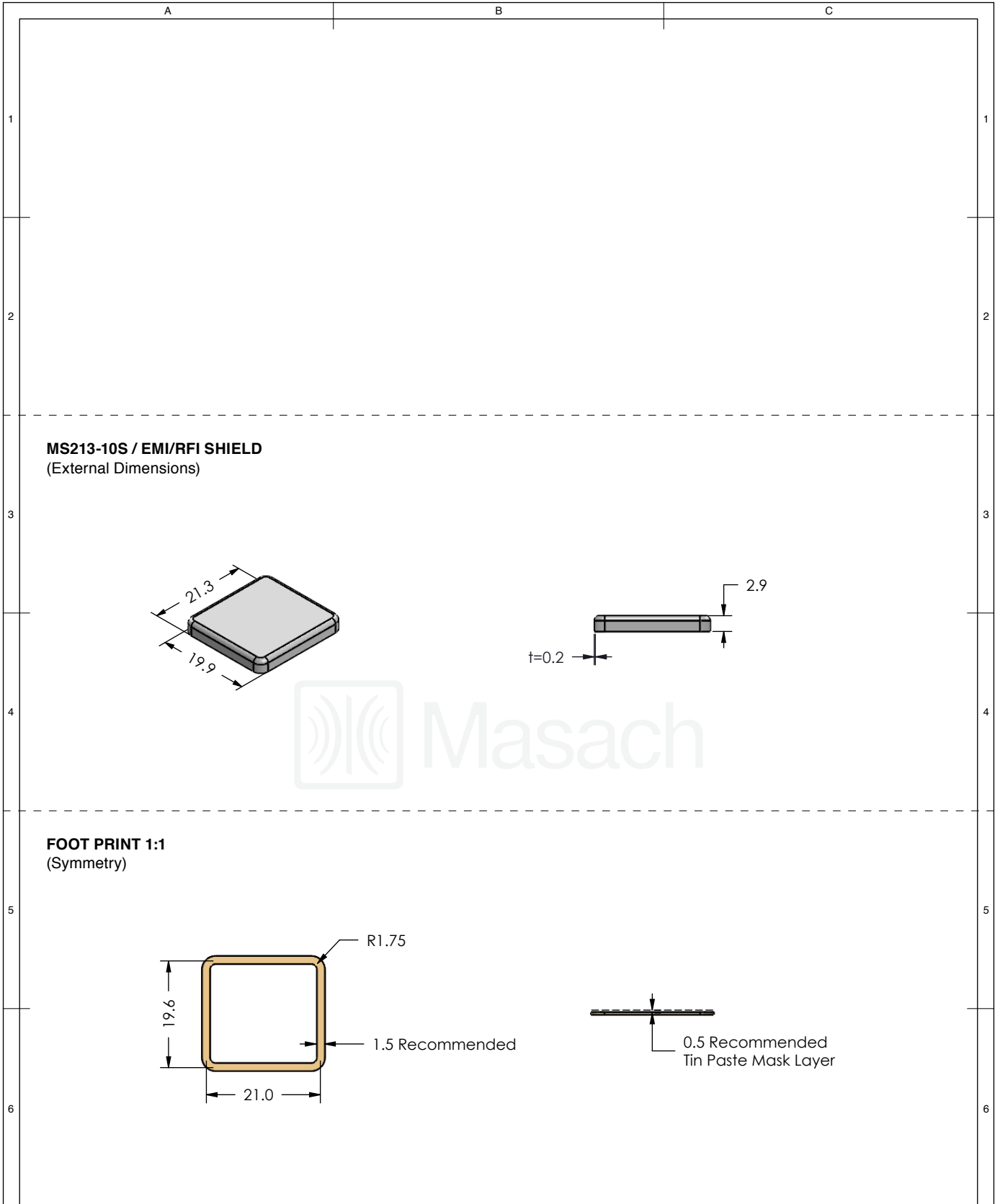

	MS ITEM PN:	DESCRIPTION:	MATERIAL:
	<b>MS213-10S</b>	<b>ONE-PIECE EMI/RF SHIELD</b>	<b>TIN PLATED STEEL (1)</b>
<b>NOTE:</b> (1) CRS ELECTROLYTIC TINPLATE (2) GENERAL TOLERANCE (+/-) 0.2MM			
© MASACH TECH LTD. 22 HAGANAN, MODIIN 7169513 ISRAEL T: (+972) 8-9754681 / F: (+972) 8-9754682 <a href="mailto:info@masach.com">info@masach.com</a> / <a href="http://www.masach.com">www.masach.com</a>	SHIELD TYPE:		
	<b>SEAMLESS PROTECTIVE EMI/RFI CAGE</b>		MMGS / PRINT 1:1 / A4

This product has been designed and manufactured by © Masach Tech Ltd. The use of this product in any type of electronic device or application is not under Masach Tech Ltd. liability.

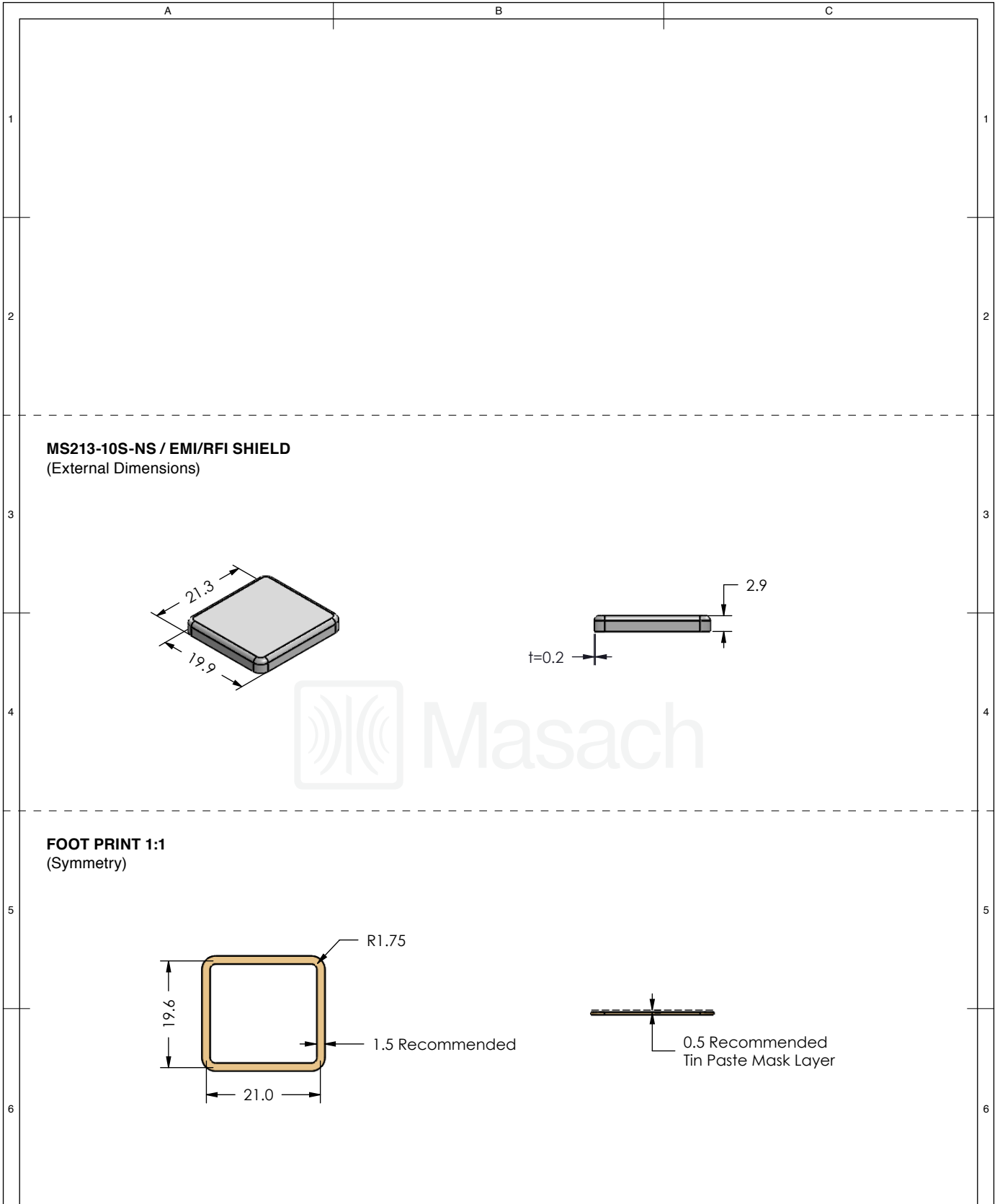

MS ITEM PN:	DESCRIPTION:	MATERIAL:
<b>MS213-10S-NS</b>	<b>ONE-PIECE EMI/RF SHIELD</b>	<b>NICKEL SILVER (1)</b>

**NOTE:** (1) UNS C77000 / UNS C73500 (2) GENERAL TOLERANCE (+/-) 0.2MM

© MASACH TECH LTD.  
 22 HAGANAN, MODIIN 7169513 ISRAEL  
 T: (+972) 8-9754681 / F: (+972) 8-9754682  
[info@masach.com](mailto:info@masach.com) / [www.masach.com](http://www.masach.com)

SHIELD TYPE:	
<b>SEAMLESS PROTECTIVE EMI/RFI CAGE</b>	

MMGS / PRINT 1:1 / A4

This product has been designed and manufactured by © Masach Tech Ltd. The use of this product in any type of electronic device or application is not under Masach Tech Ltd. liability.

A

B

C

### MS213-10\* / SMALL PACKING TRAY / SMD

\* COMPATIBLE TO ALL SHIELD CONFIGURATIONS

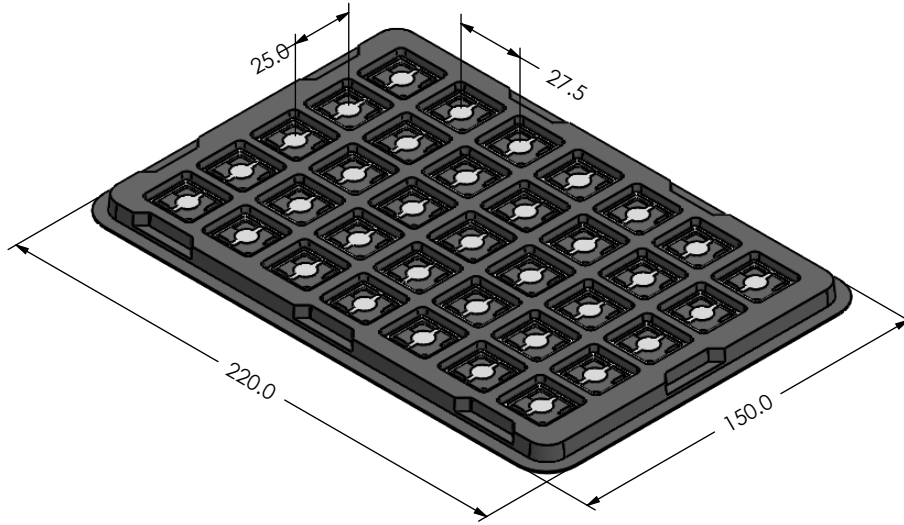

### MS213-10\* / LARGE PACKING TRAY / SMD

\* COMPATIBLE TO ALL SHIELD CONFIGURATIONS

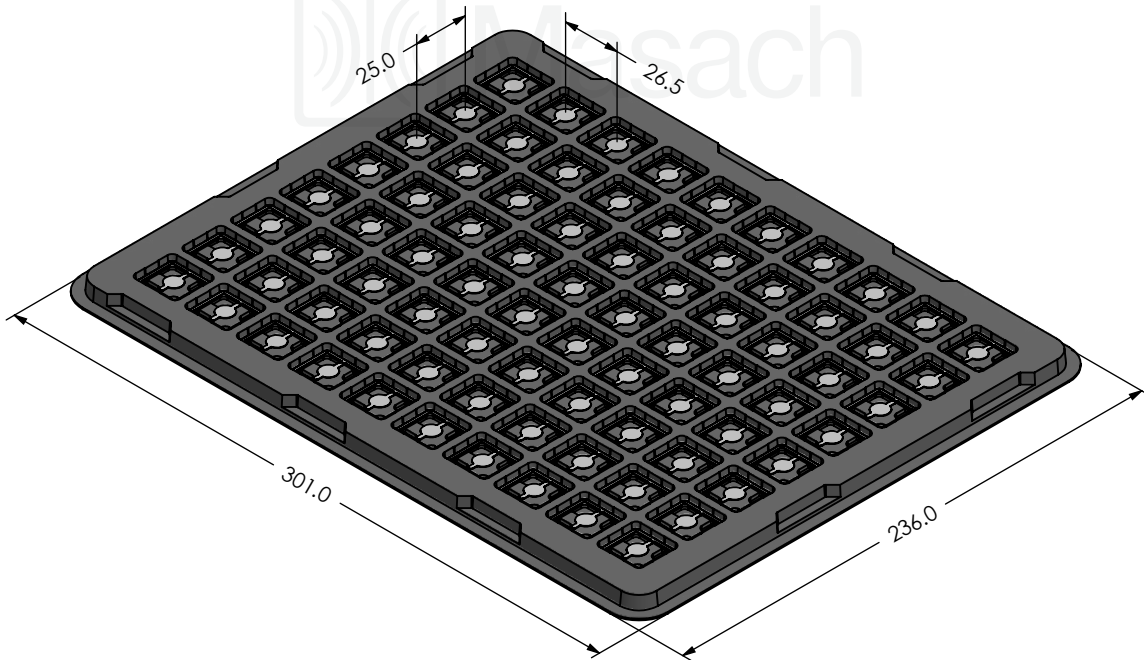

MS PN:

DESCRIPTION:

MATERIAL:

© MASACH TECH LTD.  
 22 HAGANAN, MODIIN 7169513 ISRAEL  
 T: (+972) 8-9754681 / F: (+972) 8-9754682  
 info@masach.com / www.masach.com

SHIELD TYPE:

**SEAMLESS PROTECTIVE EMI/RFI CAGE**

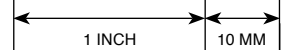

MMGS / PRINT 1:1 / A4

This product has been designed and manufactured by © Masach Tech Ltd. The use of this product in any type of electronic device or application is not under Masach Tech Ltd. liability.



Компания «Океан Электроники» предлагает заключение долгосрочных отношений при поставках импортных электронных компонентов на взаимовыгодных условиях!

Наши преимущества:

- Поставка оригинальных импортных электронных компонентов напрямую с производств Америки, Европы и Азии, а так же с крупнейших складов мира;
- Широкая линейка поставок активных и пассивных импортных электронных компонентов (более 30 млн. наименований);
- Поставка сложных, дефицитных, либо снятых с производства позиций;
- Оперативные сроки поставки под заказ (от 5 рабочих дней);
- Экспресс доставка в любую точку России;
- Помощь Конструкторского Отдела и консультации квалифицированных инженеров;
- Техническая поддержка проекта, помощь в подборе аналогов, поставка прототипов;
- Поставка электронных компонентов под контролем ВП;
- Система менеджмента качества сертифицирована по Международному стандарту ISO 9001;
- При необходимости вся продукция военного и аэрокосмического назначения проходит испытания и сертификацию в лаборатории (по согласованию с заказчиком);
- Поставка специализированных компонентов военного и аэрокосмического уровня качества (Xilinx, Altera, Analog Devices, Intersil, Interpoint, Microsemi, Actel, Aeroflex, Peregrine, VPT, Syfer, Eurofarad, Texas Instruments, MS Kennedy, Miteq, Cobham, E2V, MA-COM, Hittite, Mini-Circuits, General Dynamics и др.);

Компания «Океан Электроники» является официальным дистрибьютором и эксклюзивным представителем в России одного из крупнейших производителей разъемов военного и аэрокосмического назначения «JONHON», а так же официальным дистрибьютором и эксклюзивным представителем в России производителя высокотехнологичных и надежных решений для передачи СВЧ сигналов «FORSTAR».



## JONHON

«JONHON» (основан в 1970 г.)

Разъемы специального, военного и аэрокосмического назначения:

(Применяются в военной, авиационной, аэрокосмической, морской, железнодорожной, горно- и нефтедобывающей отраслях промышленности)

«FORSTAR» (основан в 1998 г.)

ВЧ соединители, коаксиальные кабели,  
кабельные сборки и микроволновые компоненты:

(Применяются в телекоммуникациях гражданского и специального назначения, в средствах связи, РЛС, а так же военной, авиационной и аэрокосмической отраслях промышленности).



Телефон: 8 (812) 309-75-97 (многоканальный)

Факс: 8 (812) 320-03-32

Электронная почта: [ocean@oceanchips.ru](mailto:ocean@oceanchips.ru)

Web: <http://oceanchips.ru/>

Адрес: 198099, г. Санкт-Петербург, ул. Калинина, д. 2, корп. 4, лит. А