

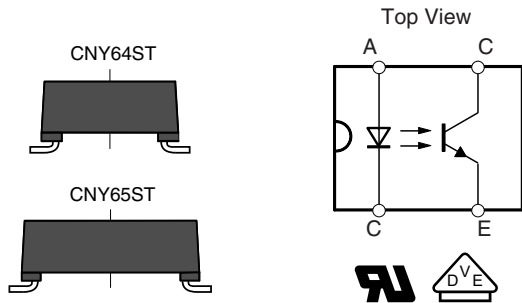

Optocoupler, Phototransistor Output, Very High Isolation Voltage



17187-6

17187-5

DESCRIPTION

The CNY6XST, the high isolation voltage SMD version optocouplers consist of a phototransistor optically coupled to a gallium arsenide infrared-emitting diode in a 4 pin plastic package.

The single components are mounted opposite one another, providing a distance between input and output for highest safety requirements of > 3 mm.

VDE STANDARDS

These couplers perform safety functions according to the following equipment standards:

- **DIN EN 60747-5-2 (VDE 0884)**
Optocoupler for electrical safety requirements
- **IEC 60065**
Safety for mains-operated electronic and related household apparatus
- **VDE 0160**
Electronic equipment for electrical power installation

FEATURES

- Rated recurring peak voltage (repetitive)
 $V_{IORM} = 1450 V_{peak}$
- Thickness through insulation ≥ 3 mm
- Creepage current resistance according to VDE 0303/IEC 60112 comparative tracking index: **CTI ≥ 475**
- Moisture sensitivity level MSL4
- Follow defined storage and soldering requirements
- Compliant to RoHS Directive 2002/95/EC and in accordance to WEEE 2002/96/EC



Note

** Please see document "Vishay Material Category Policy":
www.vishay.com/doc?99902

APPLICATIONS

- Solar and wind power diagnostic, monitoring, and communication equipment
- Welding equipment
- High voltage motors
- Switch-mode power supplies
- Line receiver
- Computer peripheral interface
- Microprocessor system interface
- Circuits for safe protective separation against electrical shock according to safety class II (reinforced isolation):
- for appl. class I to IV at mains voltage ≤ 300 V
- for appl. class I to IV at mains voltage ≤ 600 V
- for appl. class I to III at mains voltage ≤ 1000 V according to DIN EN 60747-5-2 (VDE 0884)

AGENCY APPROVALS

- DIN EN 60747-5-2 (VDE 0884) (pending)
- UL1577, file no. E76222 system code H, J, and K (pending)
- VDE related features:
- rated impulse voltage (transient overvoltage),
 $V_{IOTM} = 12 kV_{peak}$
- isolation test voltage (partial discharge test voltage),
 $V_{pd} = 2.8 kV_{peak}$

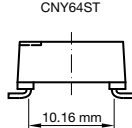
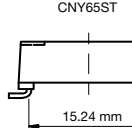
ORDERING INFORMATION				
<div style="display: flex; justify-content: space-around; align-items: center;"> <div style="border: 1px solid black; padding: 2px; margin: 2px;">C</div> <div style="border: 1px solid black; padding: 2px; margin: 2px;">N</div> <div style="border: 1px solid black; padding: 2px; margin: 2px;">Y</div> <div style="border: 1px solid black; padding: 2px; margin: 2px;">6</div> <div style="border: 1px solid black; padding: 2px; margin: 2px;">#</div> <div style="border: 1px solid black; padding: 2px; margin: 2px;">X</div> <div style="border: 1px solid black; padding: 2px; margin: 2px;">X</div> <div style="border: 1px solid black; padding: 2px; margin: 2px;">X</div> <div style="border: 1px solid black; padding: 2px; margin: 2px;">S</div> <div style="border: 1px solid black; padding: 2px; margin: 2px;">T</div> </div>	PART NUMBER		PACKAGE OPTION	CTR BIN
				
	10.16 mm	15.24 mm		
AGENCY CERTIFIED/PACKAGE	CTR (%)			
	5 mA			
UL, VDE	50 to 300	50 to 150	80 to 240	100 to 300
SMD-4 HV, 400 mil high isolation distance	CNY64ST	CNY64AYST	CNY64ABST	CNY64AGRST
SMD-4 HV, 600 mil high isolation distance	CNY65ST	CNY65AYST	CNY65ABST	CNY65AGRST



ABSOLUTE MAXIMUM RATINGS ($T_{amb} = 25\text{ }^{\circ}\text{C}$, unless otherwise specified)				
PARAMETER	TEST CONDITION	SYMBOL	VALUE	UNIT
INPUT				
Reverse voltage		V_R	5	V
Forward current		I_F	75	mA
Forward surge current	$t_p \leq 10\text{ }\mu\text{s}$	I_{FSM}	1.5	A
Power dissipation		P_{diss}	120	mW
Junction temperature		T_j	100	$^{\circ}\text{C}$
OUTPUT				
Collector emitter voltage		V_{CEO}	32	V
Emitter collector voltage		V_{ECO}	7	V
Collector current		I_C	50	mA
Collector peak current	$t_p/T = 0.5, t_p \leq 10\text{ ms}$	I_{CM}	100	mA
Power dissipation		P_{diss}	130	mW
Junction temperature		T_j	100	$^{\circ}\text{C}$
COUPLER				
AC isolation test voltage CNY64AxxxST	$t = 1\text{ min}$	V_{ISO}	8.2	kV_{RMS}
DC isolation test voltage CNY65AxxxST	$t = 1\text{ s}$	V_{ISO}	13.9	kV
Total power dissipation		P_{tot}	250	mW
Ambient temperature range		T_{amb}	- 55 to + 85	$^{\circ}\text{C}$
Storage temperature range		T_{stg}	- 55 to + 100	$^{\circ}\text{C}$
Soldering temperature	2 mm from case, $\leq 10\text{ s}$	T_{slid}	260	$^{\circ}\text{C}$

Note

- Stresses in excess of the absolute maximum ratings can cause permanent damage to the device. Functional operation of the device is not implied at these or any other conditions in excess of those given in the operational sections of this document. Exposure to absolute maximum ratings for extended periods of the time can adversely affect reliability.

ELECTRICAL CHARACTERISTICS ($T_{amb} = 25\text{ }^{\circ}\text{C}$, unless otherwise specified)						
PARAMETER	TEST CONDITION	SYMBOL	MIN.	TYP.	MAX.	UNIT
INPUT						
Forward voltage	$I_F = 50\text{ mA}$	V_F		1.32	1.6	V
Junction capacitance	$V_R = 0, f = 1\text{ MHz}$	C_j		50		pF
OUTPUT						
Collector emitter voltage	$I_C = 1\text{ mA}$	V_{CEO}	32			V
Emitter collector voltage	$I_E = 100\text{ }\mu\text{A}$	V_{ECO}	7			V
Collector emitter leakage current	$V_{CE} = 20\text{ V}, I_F = 0\text{ mA}$	I_{CEO}			200	nA
COUPLER						
Collector emitter saturation voltage	$I_F = 10\text{ mA}, I_C = 1\text{ mA}$	V_{CEsat}			0.3	V
Cut-off frequency	$V_{CE} = 5\text{ V}, I_F = 10\text{ mA}, R_L = 100\text{ }\Omega$	f_c		110		kHz
Coupling capacitance	$f = 1\text{ MHz}$	C_k		0.3		pF

Note

- Minimum and maximum values are testing requirements. Typical values are characteristics of the device and are the result of engineering evaluation. Typical values are for information only and are not part of the testing requirements.



CURRENT TRANSFER RATIO ($T_{amb} = 25\text{ }^{\circ}\text{C}$, unless otherwise specified)							
PARAMETER	TEST CONDITION	PART	SYMBOL	MIN.	TYP.	MAX.	UNIT
I_C/I_F	$V_{CE} = 5\text{ V}, I_F = 5\text{ mA}$	CNY64ST	CTR	50		300	%
		CNY65ST	CTR	50		300	%
		CNY64AYST	CTR	50		150	%
		CNY65AYST	CTR	50		150	%
		CNY64ABST	CTR	80		240	%
		CNY65ABST	CTR	80		240	%
		CNY64AGRST	CTR	100		300	%
CNY65AGRST	CTR	100		300	%		

SAFETY AND INSULATION PARAMETERS							
PARAMETER	TEST CONDITION	PART	SYMBOL	MIN.	TYP.	MAX.	UNIT
Partial discharge test voltage - routine test	100 %, $t_{test} = 1\text{ s}$		V_{pd}	2.8			kV
Partial discharge test voltage - lot test (sample test)	$t_{Tr} = 60\text{ s}, t_{test} = 10\text{ s}$, (see figure 2)		V_{pd}	2.2			kV
Insulation resistance	$V_{IO} = 500\text{ V}, T_{amb} = 25\text{ }^{\circ}\text{C}$		R_{IO}	10^{12}			Ω
	$V_{IO} = 500\text{ V}, T_{amb} = 100\text{ }^{\circ}\text{C}$		R_{IO}	10^{11}			Ω
	$V_{IO} = 500\text{ V}, T_{amb} = 150\text{ }^{\circ}\text{C}$ (construction test only)		R_{IO}	10^9			Ω
Forward current			I_{si}			120	mA
Power dissipation			P_{so}			250	mW
Rated impulse voltage			V_{IOTM}			12	kV
Safety temperature			T_{si}			150	$^{\circ}\text{C}$
Tracking resistance (comparative tracking index)	Insulation group IVa		CTI	475			
Minimum external tracking (creepage distance)	Measured from input pins to output pins	CNY64ST		≥ 9.5			mm
		CNY65ST		≥ 14			mm

Note

- According to DIN EN 60747-5-2 (see figure 2). This optocoupler is suitable for safe electrical isolation only within the safety ratings. Compliance with the safety ratings shall be ensured by means of suitable protective circuits.

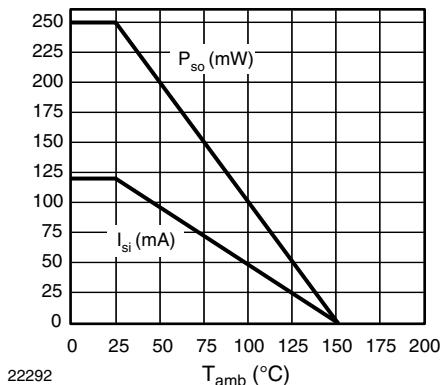

Fig. 1 - Safety Derating Diagram

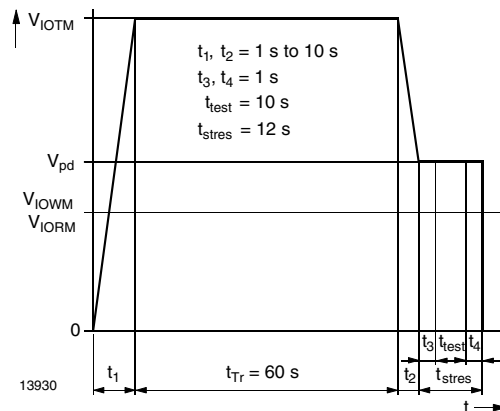

Fig. 2 - Test Pulse Diagram for Sample Test According to DIN EN 60747-5-2 (VDE 0884); IEC60747-5-5



SWITCHING CHARACTERISTICS						
PARAMETER	TEST CONDITION	SYMBOL	MIN.	TYP.	MAX.	UNIT
Delay time	$V_S = 5\text{ V}$, $I_C = 5\text{ mA}$, $R_L = 100\ \Omega$, (see figure 3)	t_d		2.6		μs
Rise time	$V_S = 5\text{ V}$, $I_C = 5\text{ mA}$, $R_L = 100\ \Omega$, (see figure 3)	t_r		2.4		μs
Fall time	$V_S = 5\text{ V}$, $I_C = 5\text{ mA}$, $R_L = 100\ \Omega$, (see figure 3)	t_f		2.7		μs
Storage time	$V_S = 5\text{ V}$, $I_C = 5\text{ mA}$, $R_L = 100\ \Omega$, (see figure 3)	t_s		0.3		μs
Turn-on time	$V_S = 5\text{ V}$, $I_C = 5\text{ mA}$, $R_L = 100\ \Omega$, (see figure 3)	t_{on}		5		μs
Turn-off time	$V_S = 5\text{ V}$, $I_C = 5\text{ mA}$, $R_L = 100\ \Omega$, (see figure 3)	t_{off}		3		μs
Turn-on time	$V_S = 5\text{ V}$, $I_F = 10\text{ mA}$, $R_L = 1\text{ k}\Omega$, (see figure 4)	t_{on}		25		μs
Turn-off time	$V_S = 5\text{ V}$, $I_F = 10\text{ mA}$, $R_L = 1\text{ k}\Omega$, (see figure 4)	t_{off}		42.5		μs

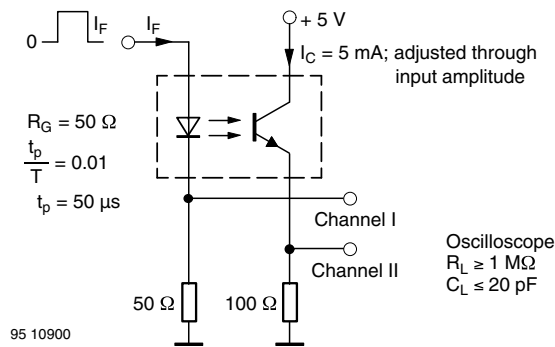

Fig. 3 - Test Circuit, Non-Saturated Operation

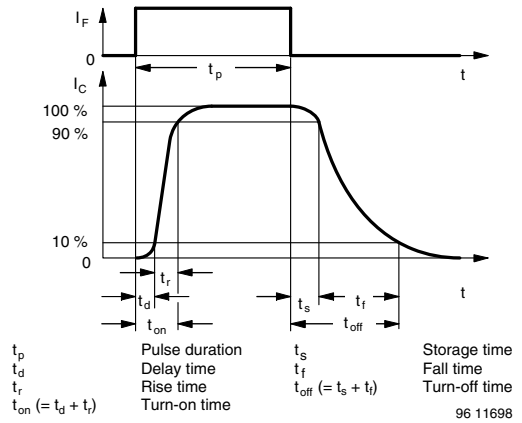

Fig. 5 - Switching Times

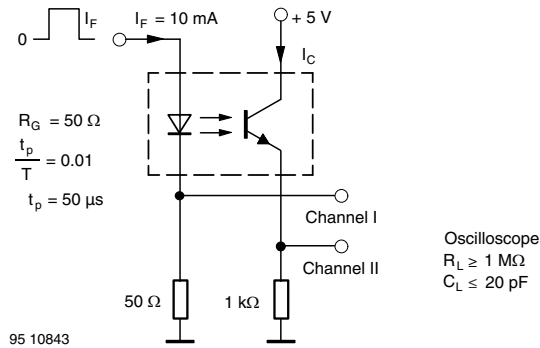

Fig. 4 - Test Circuit, Saturated Operation



TYPICAL CHARACTERISTICS ($T_{amb} = 25\text{ }^{\circ}\text{C}$, unless otherwise specified)

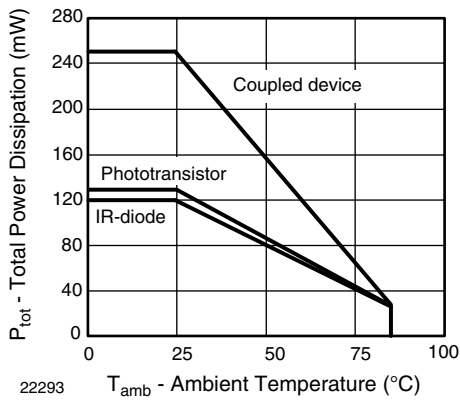

Fig. 6 - Total Power Dissipation vs. Ambient Temperature

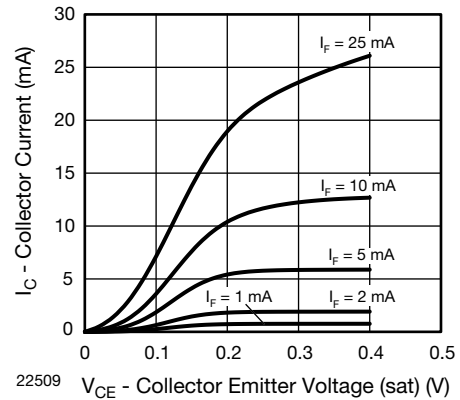

Fig. 9 - Collector Current vs. Collector Emitter Voltage

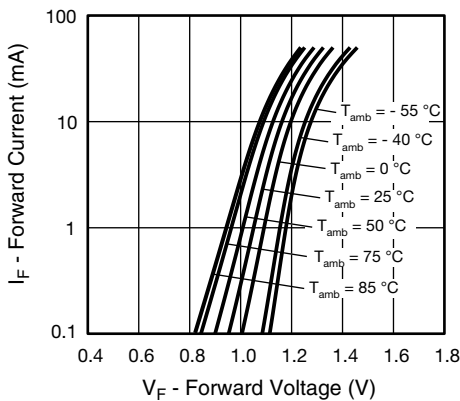

Fig. 7 - Forward Current vs. Forward Voltage

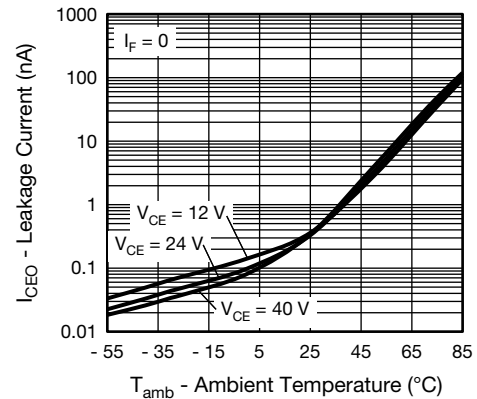

Fig. 10 - Leakage Current vs. Ambient Temperature

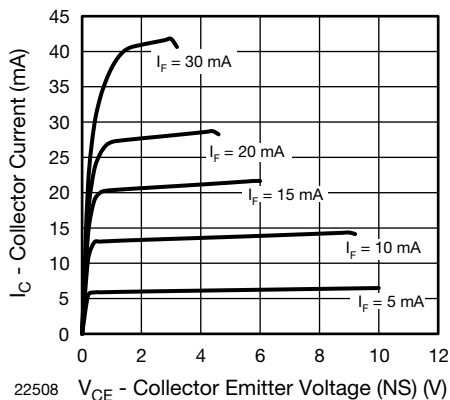

Fig. 8 - Collector Current vs. Collector Emitter Voltage (NS)

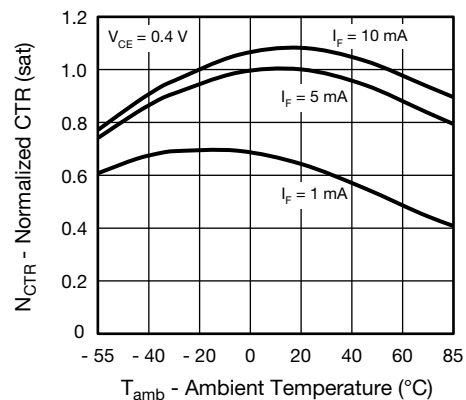

Fig. 11 - Normalized CTR (sat) vs. Ambient Temperature

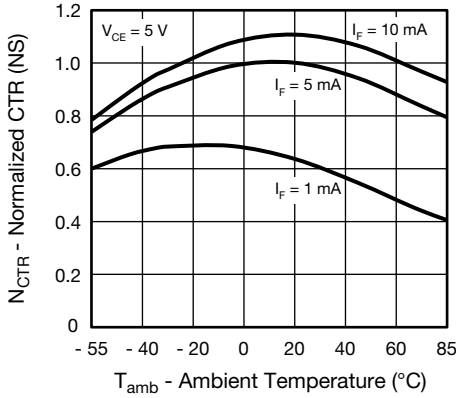

Fig. 12 - Normalized CTR (NS) vs. Ambient Temperature

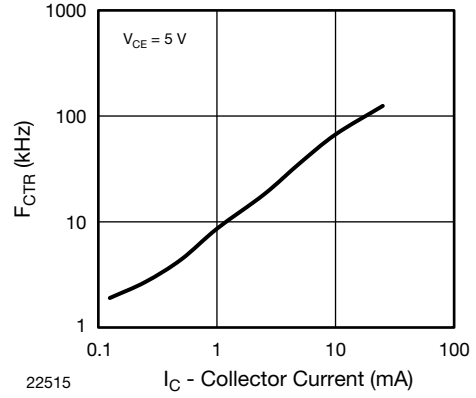

Fig. 15 - F_CTR vs. Collector Current

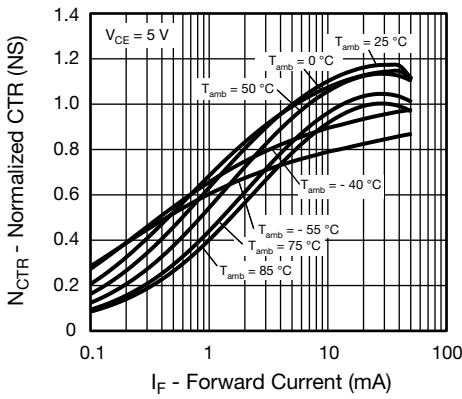

Fig. 13 - Normalized CTR (NS) vs. Forward Current

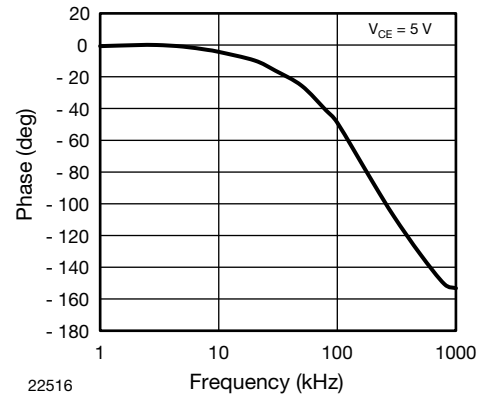

Fig. 16 - F_CTR vs. Phase Angle

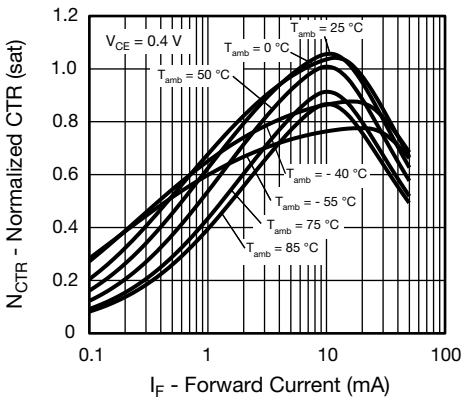

Fig. 14 - Normalized CTR (sat) vs. Forward Current

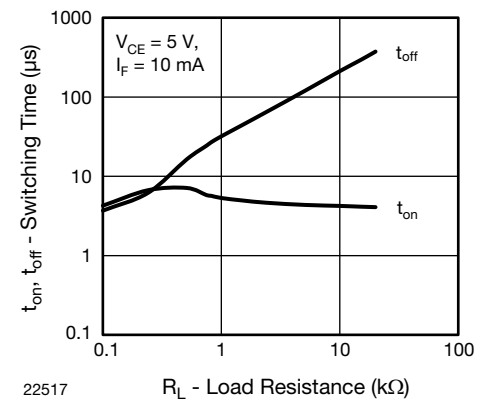

Fig. 17 - Switching Time vs. Load Resistance



SOLDERING GUIDLINES

Soldering Condition

The CNY64AxST, CNY65AxST are lead (Pb)-free devices. They are suitable for reflow soldering. However due to large package size, the peak package body temperature should not go above 245 °C.

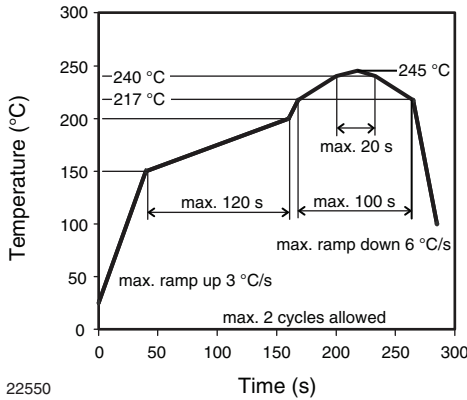

Drypack

Devices are packed in moisture barrier bags (MBB) to prevent moisture absorption during transportation and storage. Each bag contains a desiccant bag.

Floor Life

Floor life (time between soldering and removing from MBB) must not exceed the time indicated on MBB label:

Floor life: 72 h

Conditions: $T_{amb} < 30\text{ °C}$, $RH < 60\%$

Moisture sensitivity level 4, according to J-STD-020.

Drying

In case of moisture absorption devices should be baked before soldering according to the recommended conditions shown below

48 h at $125\text{ °C} \pm 5\text{ °C}$, $RH < 5\%$

(Not suitable for tape and reel)

In case the floor time has not exceeded 10 days the units can be baked in tape and reel according to the following conditions

168 h at $60\text{ °C} \pm 5\text{ °C}$, $RH < 5\%$

(Not suitable, if the floor time was exceeded by more than 10 days, or the allowed factory condition is exceeded)

PACKAGE DIMENSIONS in millimeters **FOR CNY64AxxxST**

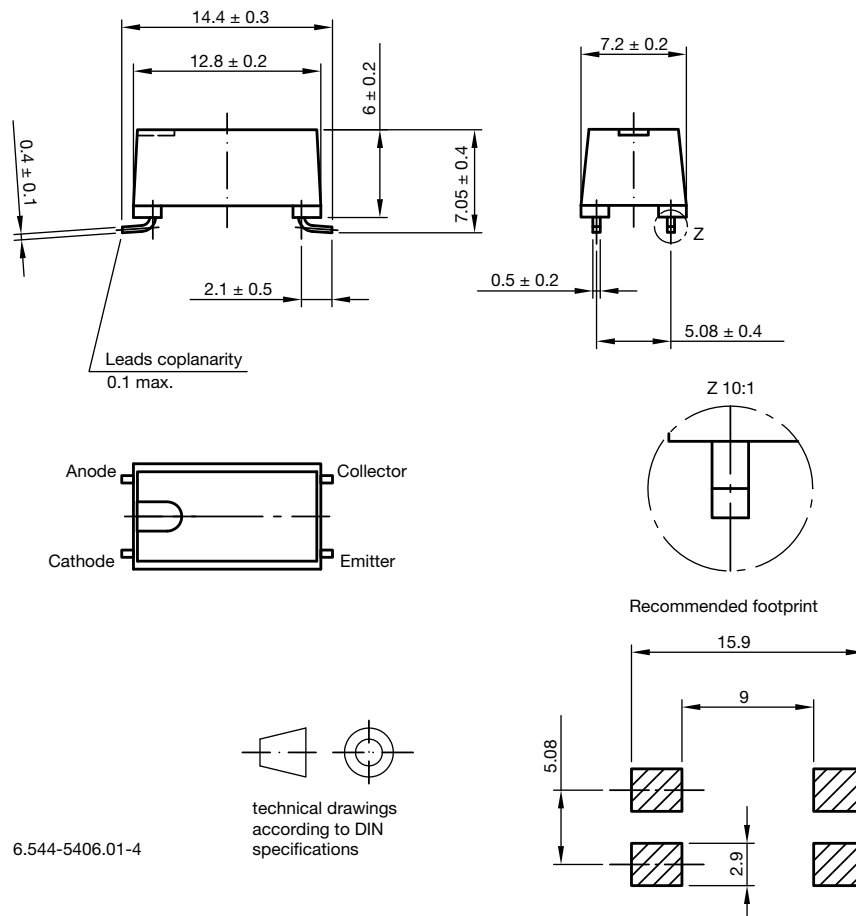



PACKAGE DIMENSIONS in millimeters FOR CNY65AxxxST

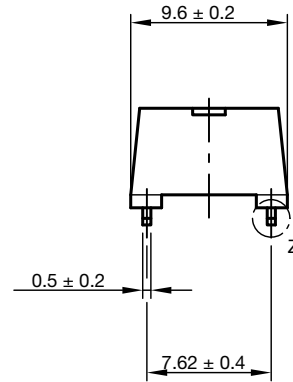
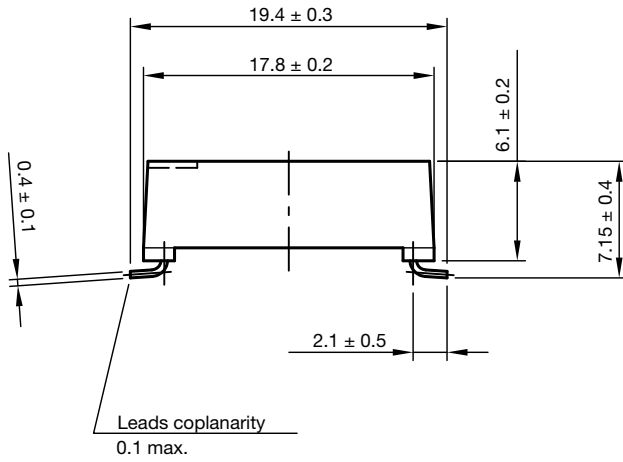

Z 10:1

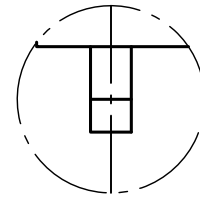

Recommended footprint

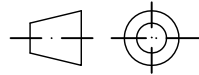
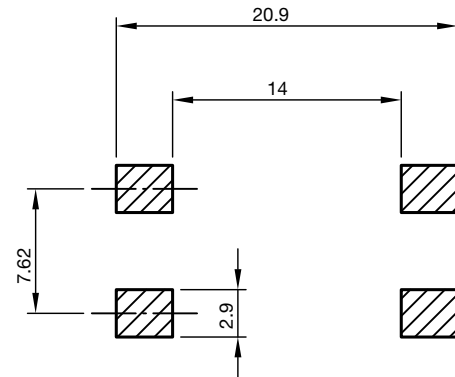
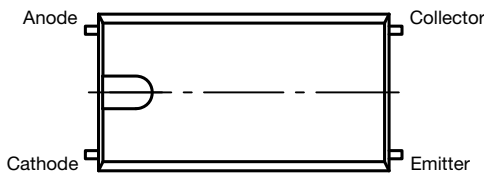

technical drawings according to DIN specifications

6.544-5404.01-4

PACKAGE MARKING (example)

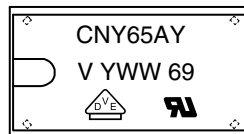

Note

- The "T" at the end of the product designation is not marked on the package



TAPE DIMENSIONS in millimeters **FOR CNY64AxxxST**

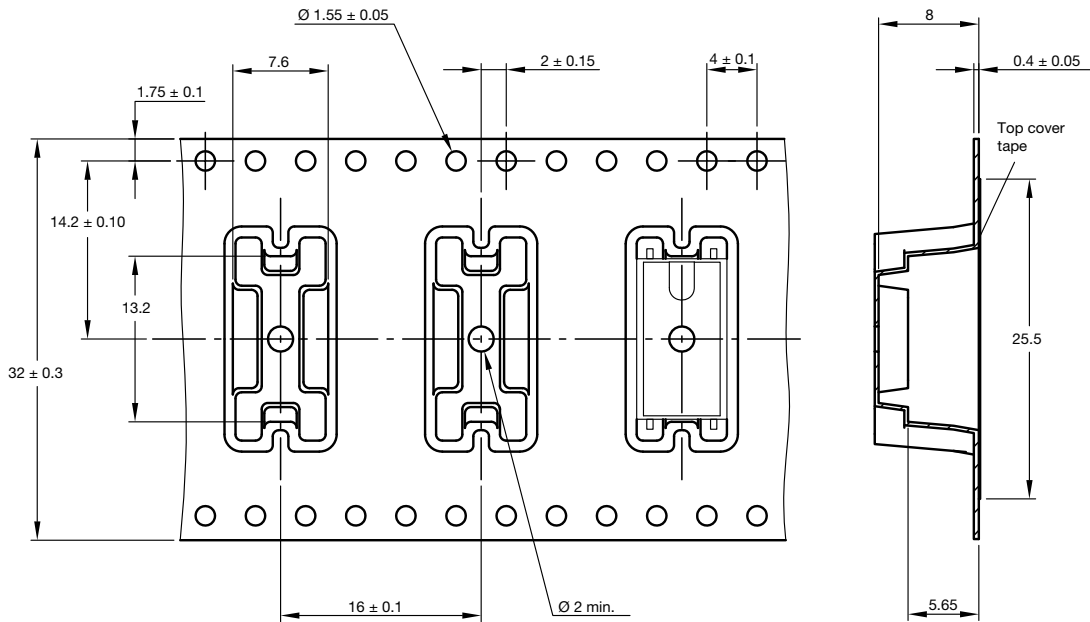

Direction of feed →

Leader (start) min. 400 mm without devices
Trailer (end) min. 200 mm without devices

Drawing-No.: 9.700-5375.01-4
Issue: 1; 23.05.11

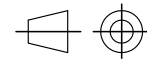

technical drawings according to DIN specifications

TAPE DIMENSIONS in millimeters **FOR CNY65AxxxST**

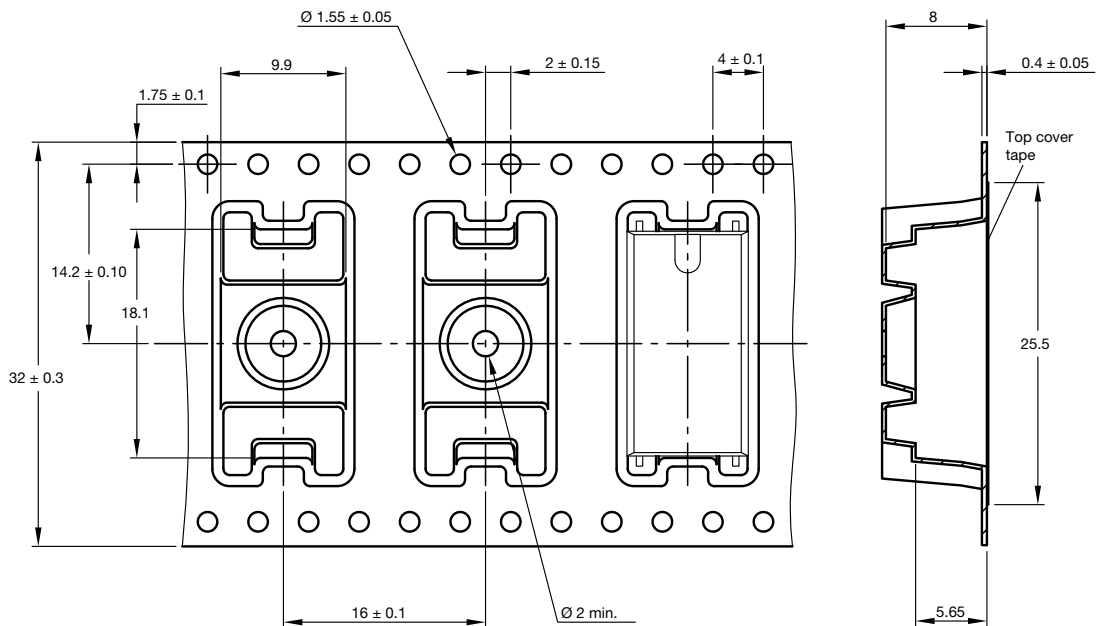

Direction of feed →

Leader (start) min. 400 mm without devices
Trailer (end) min. 200 mm without devices

Drawing-No.: 9.700-5376.01-4
Issue: 1; 23.05.11

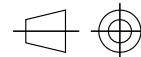

technical drawings according to DIN specifications



REEL DIMENSIONS in millimeters

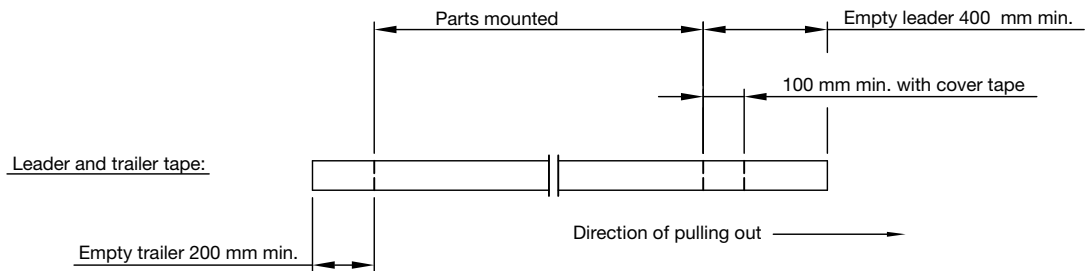
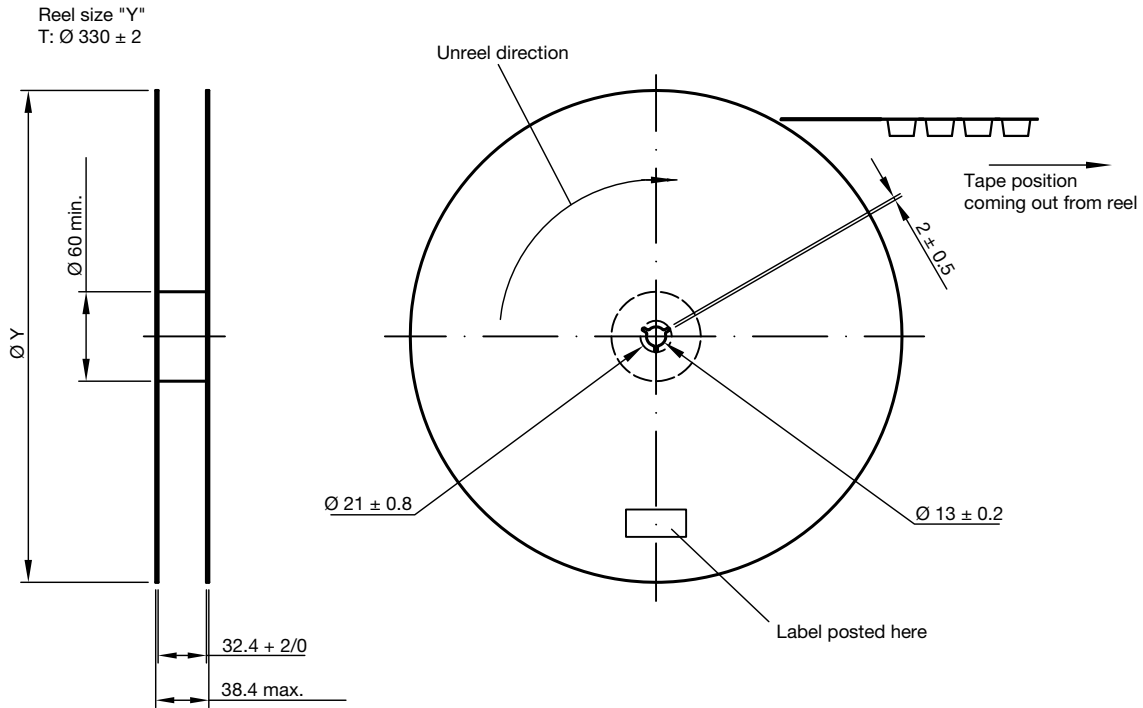

Not indicated tolerances ± 0.1

Drawing-No.: 9.800-5120.01-4

Issue: 1; 23.05.11

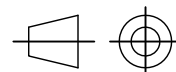

technical drawings according to DIN specifications



Disclaimer

ALL PRODUCT, PRODUCT SPECIFICATIONS AND DATA ARE SUBJECT TO CHANGE WITHOUT NOTICE TO IMPROVE RELIABILITY, FUNCTION OR DESIGN OR OTHERWISE.

Vishay Intertechnology, Inc., its affiliates, agents, and employees, and all persons acting on its or their behalf (collectively, "Vishay"), disclaim any and all liability for any errors, inaccuracies or incompleteness contained in any datasheet or in any other disclosure relating to any product.

Vishay makes no warranty, representation or guarantee regarding the suitability of the products for any particular purpose or the continuing production of any product. To the maximum extent permitted by applicable law, Vishay disclaims (i) any and all liability arising out of the application or use of any product, (ii) any and all liability, including without limitation special, consequential or incidental damages, and (iii) any and all implied warranties, including warranties of fitness for particular purpose, non-infringement and merchantability.

Statements regarding the suitability of products for certain types of applications are based on Vishay's knowledge of typical requirements that are often placed on Vishay products in generic applications. Such statements are not binding statements about the suitability of products for a particular application. It is the customer's responsibility to validate that a particular product with the properties described in the product specification is suitable for use in a particular application. Parameters provided in datasheets and/or specifications may vary in different applications and performance may vary over time. All operating parameters, including typical parameters, must be validated for each customer application by the customer's technical experts. Product specifications do not expand or otherwise modify Vishay's terms and conditions of purchase, including but not limited to the warranty expressed therein.

Except as expressly indicated in writing, Vishay products are not designed for use in medical, life-saving, or life-sustaining applications or for any other application in which the failure of the Vishay product could result in personal injury or death. Customers using or selling Vishay products not expressly indicated for use in such applications do so at their own risk. Please contact authorized Vishay personnel to obtain written terms and conditions regarding products designed for such applications.

No license, express or implied, by estoppel or otherwise, to any intellectual property rights is granted by this document or by any conduct of Vishay. Product names and markings noted herein may be trademarks of their respective owners.

Material Category Policy

Vishay Intertechnology, Inc. hereby certifies that all its products that are identified as RoHS-Compliant fulfill the definitions and restrictions defined under Directive 2011/65/EU of The European Parliament and of the Council of June 8, 2011 on the restriction of the use of certain hazardous substances in electrical and electronic equipment (EEE) - recast, unless otherwise specified as non-compliant.

Please note that some Vishay documentation may still make reference to RoHS Directive 2002/95/EC. We confirm that all the products identified as being compliant to Directive 2002/95/EC conform to Directive 2011/65/EU.

Vishay Intertechnology, Inc. hereby certifies that all its products that are identified as Halogen-Free follow Halogen-Free requirements as per JEDEC JS709A standards. Please note that some Vishay documentation may still make reference to the IEC 61249-2-21 definition. We confirm that all the products identified as being compliant to IEC 61249-2-21 conform to JEDEC JS709A standards.

Компания «Океан Электроники» предлагает заключение долгосрочных отношений при поставках импортных электронных компонентов на взаимовыгодных условиях!

Наши преимущества:

- Поставка оригинальных импортных электронных компонентов напрямую с производств Америки, Европы и Азии, а так же с крупнейших складов мира;
- Широкая линейка поставок активных и пассивных импортных электронных компонентов (более 30 млн. наименований);
- Поставка сложных, дефицитных, либо снятых с производства позиций;
- Оперативные сроки поставки под заказ (от 5 рабочих дней);
- Экспресс доставка в любую точку России;
- Помощь Конструкторского Отдела и консультации квалифицированных инженеров;
- Техническая поддержка проекта, помощь в подборе аналогов, поставка прототипов;
- Поставка электронных компонентов под контролем ВП;
- Система менеджмента качества сертифицирована по Международному стандарту ISO 9001;
- При необходимости вся продукция военного и аэрокосмического назначения проходит испытания и сертификацию в лаборатории (по согласованию с заказчиком);
- Поставка специализированных компонентов военного и аэрокосмического уровня качества (Xilinx, Altera, Analog Devices, Intersil, Interpoint, Microsemi, Actel, Aeroflex, Peregrine, VPT, Syfer, Eurofarad, Texas Instruments, MS Kennedy, Miteq, Cobham, E2V, MA-COM, Hittite, Mini-Circuits, General Dynamics и др.);

Компания «Океан Электроники» является официальным дистрибьютором и эксклюзивным представителем в России одного из крупнейших производителей разъемов военного и аэрокосмического назначения «JONHON», а так же официальным дистрибьютором и эксклюзивным представителем в России производителя высокотехнологичных и надежных решений для передачи СВЧ сигналов «FORSTAR».



JONHON

«JONHON» (основан в 1970 г.)

Разъемы специального, военного и аэрокосмического назначения:

(Применяются в военной, авиационной, аэрокосмической, морской, железнодорожной, горно- и нефтедобывающей отраслях промышленности)

«FORSTAR» (основан в 1998 г.)

ВЧ соединители, коаксиальные кабели, кабельные сборки и микроволновые компоненты:

(Применяются в телекоммуникациях гражданского и специального назначения, в средствах связи, РЛС, а так же военной, авиационной и аэрокосмической отраслях промышленности).



Телефон: 8 (812) 309-75-97 (многоканальный)

Факс: 8 (812) 320-03-32

Электронная почта: ocean@oceanchips.ru

Web: <http://oceanchips.ru/>

Адрес: 198099, г. Санкт-Петербург, ул. Калинина, д. 2, корп. 4, лит. А