

ACE series

AC - - -

① ② ③ ④ ⑤ ⑥ ⑦ ⑧ ⑨ ⑩



Recommended EMI/EMC Filter
 ACE300F NAC-06-472
 ACE450F NAC-10-472
 ACE650F NAC-20-472
 ACE900F NAC-20-472



High voltage pulse noise type : NAP series
 Low leakage current type : NAM series
 *The EMI/EMC Filter is recommended to connect with several devices.

- ① Abbreviation type name of ACE series
- ② Abbreviation power of ACE series
- 3 : ACE300F
- 4 : ACE450F
- 6 : ACE650F
- 9 : ACE900F
- ③ Slot 6 Output module
- ④ Slot 5 Output module
- ⑤ Slot 4 Output module
- ⑥ Slot 3 Output module
- ⑦ Slot 2 Output module
- ⑧ Slot 1 Output module
- ⑨ Parallel code
- ⑩ Option (series code) *8 Refer to instruction manual 5.1 Safety : UL60601-1, EN60601-1 Refer to instruction manual 7. for details.



Slot
 *The number of slot is different depending on the model.
 *Empty slot is code:0

SPECIFICATIONS

	MODEL	ACE300F	ACE450F	ACE650F	ACE900F	
INPUT	VOLTAGE[V]	AC85 - 264 1 φ / DC120 - 350 (option=-U AC70 or DC100 - refer to instruction manual 5)				
	FREQUENCY[Hz]	47 - 63				
	CURRENT[A]	AC100V *1	3.7typ	5.7typ	8.0typ	11typ
		AC200V *1	2.0typ	3.1typ	4.2typ	5.7typ
	POWER FACTOR	AC100V *1	0.99typ			
		AC200V *1	0.95typ			
	INRUSH CURRENT [A]	AC100V *2	15 / 30typ *7			15 / 50typ *7
		AC200V *2	30 / 30typ *7			30 / 50typ *7
	EFFICIENCY[%]	AC100V *1	74typ	75typ	77typ	77typ
		AC200V *1	78typ	78typ	80typ	80typ
LEAKAGE CURRENT[mA]	AC100V *3	0.5max				
	AC230V *3	0.95max				
OUTPUT	NUMBER OF SLOT	4	5	5	6	
	TOTAL OUTPUT[W]	AC90 - 150V *4	250	400	600	800 (Peak 1k)
		AC170 - 264V *4	300	450	650	900 (Peak 1k)
	START-UP TIME[ms]	500max (ACIN100V, Io=100%)				
HOLD-UP TIME[ms] *1	20typ (ACIN100V, Io=100%)					
FUNCTION	AUXILIARY POWER (AUX)	12V 0.1A (Only for Remote ON/OFF) (option=-J 5V0.1A)				
	ALARM (PR)	FAN alarm, LINE alarm				
ISOLATION	INPUT-OUTPUT, RC, AUX	AC3,000V 1minute, Cutoff current=10mA, DC500V 50MΩ min (At Room Temperature)				
	INPUT-FG	AC2,000V 1minute, Cutoff current=10mA, DC500V 50MΩ min (At Room Temperature)				
	OUTPUT, RC, AUX(PR)-FG *5	AC500V 1minute, Cutoff current=100mA, DC500V 50MΩ min (At Room Temperature)				
ENVIRONMENT	OPERATING TEMP., HUMID. AND ALTITUDE *4	-20 to +70°C, 20 - 90%RH (Non condensing) 3,000m (10,000feet) max				
	STORAGE TEMP., HUMID. AND ALTITUDE	-20 to +75°C, 20 - 90%RH (Non condensing) 9,000m (30,000feet) max				
	VIBRATION	19.6m/s ² (2G) , 10 - 55Hz, 3minutes period, 60minutes each along X, Y and Z axis				
	IMPACT	196.1m/s ² (20G) , 11ms, once each X, Y and Z axis				
SAFETY AND NOISE REGULATIONS	AGENCY APPROVALS	UL60950-1, C-UL (CSA60950-1), EN60950-1, EN50178, Complies with DEN-AN (At only AC input) UL60601-1, EN60601-1 (At only AC input) (Refer to instruction manual 7)				
	CONDUCTED NOISE	Complies with FCC-B, VCCI-B, CISPR22-B and EN55022-B				
	HARMONIC ATTENUATOR	Complies with IEC61000-3-2 *9				
OTHERS	CASE SIZE *6	103×63.5×254mm (W×H×D) [4.06×2.5×10 inches]	127×63.5×254mm (W×H×D) [5×2.5×10 inches]	127×63.5×279mm (W×H×D) [5×2.5×10.98 inches]	177.5×63.5×254mm (W×H×D) [6.99×2.5×10 inches]	
	WEIGHT[kg]	1.7max	2.2max	2.4max	3.0max	
	COOLING METHOD	Forced cooling (built-in)				

*1 In case of modular power supply, the value changes by composing and load factor of installed output modules. The values in specifications mean each the model are composed of voluntary modules that are 5V (code : C), 12V (code : E), 24V (code : H) and the output power is total

output wattage under the prescribed conditions.
 *2 More than 3sec. to restart. Io=100%
 *3 Complies with IEC60950 and DEN-AN 60Hz and 100% load.
 *4 Refer to instruction manual 4.2 Derating in detail.
 *5 Each output module, RC and AUX are isolated.

*6 Case size contains neither the terminal blocks, screw nor.
 *7 Primary inrush current / Secondary inrush current.
 *8 Please contact us about safety approvals for the model with option.
 *9 Please contact us about class C.
 * A sound may occur from power supply at pulse loading.

Output module specifications

ITEM	CODE	150W suitable single output										50W suitable single output					75W dual output						
		A	B	C	D	E	F	G	H	J	K	L	M	N	P	R	Y*7	W*7	Z*7	9*7			
Number of slots used		1	1	1	1	1	1	1	1	1	1	1	1	1	1	1	1	1	1	1			
VOLTAGE[V]		+2	+3.3	+5	+7.5	+12	+15	+18	+24	+34	+48	+3.3	+5	+12	+15	+24	±5	±12	±15	±24			
MINIMUM CURRENT[A]		0	0	0	0	0	0	0	0	0	0	0	0	0	0	0	0	0	0	0			
CURRENT1[A]		26	26	26	18	13	10	8.5	6.5	4.5	3.2	10	10	5	4	2.5	3	3.2	2.5	1.6			
CURRENT2[A]		—	—	—	—	—	—	—	—	—	—	—	—	—	—	—	7	4.2	3.5	2.5			
PEAK CURRENT[A]	*1	—	—	—	—	14	12	10	8	5.5	4	—	—	—	—	—	—	5	4	—			
LINE REGULATION[mV]max		20	20	20	36	48	60	72	96	120	192	20	20	48	60	96	20	48	60	60			
LOAD REGULATION1[mV]max*5		40	40	40	100	100	120	120	150	180	300	40	40	100	120	150	250	600	600	600			
LOAD REGULATION2[mV]max*6		—	—	—	—	—	—	—	—	—	—	—	—	—	—	—	500	750	750	750			
RIPPLE [mVp-p]max	0 to +50°C *2	80	80	80	120	120	120	120	120	120	150	80	80	120	120	120	80	120	120	120			
	-20 to 0°C *2	140	140	140	160	160	160	160	160	160	300	140	140	160	160	160	140	160	160	160			
RIPPLE NOISE [mVp-p]max	0 to +50°C *2	120	120	120	150	150	150	150	150	150	350	120	120	150	150	150	120	150	150	150			
	-20 to 0°C *2	160	160	160	180	180	180	180	180	180	400	160	160	180	180	180	160	180	180	180			
TEMPERATURE COEFFICIENT[mV]max	0 to +50°C	50	50	50	90	120	150	180	240	300	480	50	50	120	150	240	50	120	150	150			
DRIFT[mV]max	*3	20	20	20	36	48	60	72	96	120	192	20	20	48	60	96	20	48	60	60			
OUTPUT VOLTAGE SETTING[V]		2.00-2.20	3.25-3.45	4.99-5.30	7.20-7.80	11.5-12.5	14.4-15.6	17.3-18.7	23.0-25.0	33.0-35.0	46.0-50.0	3.25-3.45	4.99-5.30	11.5-12.5	14.4-15.6	23.0-25.0	4.99-5.30	11.5-12.5	14.4-15.6	23.0-25.0			
OUTPUT VOLTAGE ADJUSTMENT RANGE[V]	*4	1.60-2.60	2.60-3.60	4.00-5.50	6.00-8.20	9.00-13.2	13.2-16.5	16.5-19.2	19.2-26.4	27.2-37.4	38.4-52.8	2.60-3.60	4.00-5.50	9.00-13.2	13.2-16.5	19.2-26.4	4.99-6.00	9.60-13.2	13.2-16.5	19.2-26.4			
OVERCURRENT PROTECTION[A]		Works over 105%min of rated current or 101%min of peak current. Automatic recovery.																					
OVERVOLTAGE PROTECTION[V]		3.00-4.80	4.00-5.25	Works at 115 - 140% of rated voltage										4.00-5.25	Works at 115 - 140% of rated voltage					6.90-8.40	13.8-16.8	17.25-21.0	27.6-33.6
FUNCTION		Remotesensing, remote ON/OFF, alarm (LV)										Remote ON/OFF, alarm (LV)											

ITEM	CODE	300W suitable single output										100W insulation dual output						150W dual output		I	
		2A	2B	2C	2D	2E	2F	2G	2H	2J	2K	S*8	T*8	U*8	Q*7	V*7					
Number of slots used		2	2	2	2	2	2	2	2	2	2	1	1	1	1	1	1	1	1	1	
VOLTAGE[V]		+2	+3.3	+5	+7.5	+12	+15	+18	+24	+34	+48	V1:+5	V2:+5	V1:+5	V2:+12	V1:+5	V2:+24	±12	±15		
MINIMUM CURRENT[A]		0	0	0	0	0	0	0	0	0	0	0	0	0	0	0	0	0	0	0	
CURRENT1[A]		60	60	60	40	25	20	17	14	10	7	10	5	10	4.2	10	2.1	6.4	5.5		
CURRENT2[A]		—	—	—	—	—	—	—	—	—	—	—	—	—	—	—	—	8	7		
PEAK CURRENT[A]	*1	—	—	—	—	34	27	23	20	14	10	—	—	—	—	—	—	10	8		
LINE REGULATION[mV]max		20	20	20	36	48	60	72	96	120	192	20	20	20	48	20	96	48	60		
LOAD REGULATION1[mV]max*5		40	40	40	100	100	120	120	150	180	300	40	40	40	100	40	150	600	600		
LOAD REGULATION2[mV]max*6		—	—	—	—	—	—	—	—	—	—	—	—	—	—	—	—	750	750		
RIPPLE [mVp-p]max	0 to +50°C *2	80	80	80	120	120	120	120	120	120	150	80	80	80	120	80	120	140	140		
	-20 to 0°C *2	140	140	140	160	160	160	160	160	160	300	140	140	140	160	140	160	200	200		
RIPPLE NOISE [mVp-p]max	0 to +50°C *2	120	120	120	150	150	150	150	150	150	350	120	120	120	150	120	150	230	230		
	-20 to 0°C *2	160	160	160	180	180	180	180	180	180	400	160	160	160	180	160	180	350	350		
TEMPERATURE COEFFICIENT[mV]max	0 to +50°C	50	50	50	90	120	150	180	240	300	480	50	50	50	120	50	240	120	150		
DRIFT[mV]max	*3	20	20	20	36	48	60	72	96	120	192	20	20	20	48	20	96	48	60		
OUTPUT VOLTAGE SETTING[V]		2.00-2.20	3.25-3.45	4.99-5.30	7.20-7.80	11.5-12.5	14.4-15.6	17.3-18.7	23.0-25.0	33.0-35.0	46.0-50.0	4.99-5.30	4.99-5.30	4.99-5.30	11.5-12.5	4.99-5.30	23.0-25.0	11.5-12.5	14.4-15.6		
OUTPUT VOLTAGE ADJUSTMENT RANGE[V]		1.60-2.60	2.60-3.60	4.00-5.50	6.00-8.20	9.00-13.2	13.2-16.5	16.5-19.2	19.2-26.4	27.2-37.4	38.4-52.8	4.99-5.50	3.00-5.50	4.99-5.50	7.50-13.2	4.99-5.50	15.0-26.4	9.60-13.2	13.2-16.5		
OVERCURRENT PROTECTION[A]		Works over 105%min of rated current or 101%min of peak current. Automatic recovery.																			
OVERVOLTAGE PROTECTION[V]		3.00-4.80	4.00-5.25	Works at 115 - 140% of rated voltage										Remote ON/OFF						Same as W,Z	—
FUNCTION		Remotesensing, remote ON/OFF, alarm (LV)										Remote ON/OFF						Same as W,Z		—	

Input module Refer to instruction manual 6 Input.

ACE

- *1 Operating condition of peak current : Peak current is less than 10sec, duty is less than 35% and average current is less than rated current. (rated current2 at Module W, Z, 9, Q and V)
- *2 Measured by 20MHz oscilloscope or Ripple-Noise meter (Equivalent to KEISOKU-GIKEN : RM101). Ripple and Ripple Noise is measured by using measuring board with capacitor of 22 μF within 150mm from output terminal.
- *3 Drift is changed in DC output for an eight hour period after half-hour warm-up at 25°C, with the input voltage held constant at the rated input/output.
- *4 When the output voltage of module A is used less than 2.0V, keep minimum output current 2.6A.
- *5 It is a value from 0 to rated output current1. The current on non-measurement side is fixed.
- *6 It is a value from 0 to rated output current2. The current on non-measurement side is fixed.
- *7 The sum of +power and -power must be less than output power(Y:50W, W:76.8W, Z:75W, 9:76.8W, Q:153.6W, V:165W).

- *8 Ratings of V2 can draw up to 50% of rated current at the time of 0A in load of V1. (Only module S,T,U. refer to instruction manual 4.2 for details.)
- * Each output of module Y-Z, 9, Q and V is a ground common type (not isolated), each output of module S,T and U is isolated.
- * For ACE300F,450F and 650F , input and output terminals can be set at the same side if Input module (code:I) is installed instead of the most left module.
- * Modules which can correspond to medical electrical equipment (UL2601-1, EN60601-1) are all modules except module S, T and U. Refer to instruction manual 7. for details.

Block diagram



ACE300F external view



Pin connection and function of CN1

Pin No.	Function
1	G : Auxiliary power ground
2	PR : PR alarm
3	AUX : Auxiliary power (only remote ON/OFF)

Mating connector and terminal of CN1

Connector	Mating connector	Terminal	Mfr.
CN1	S3B-XH-A	XHP-3	J.S.T.
		Reel : SXH-001T-P0.6	
		Bulk : BXH-001T-P0.6	

- ※ Tolerance : ± 1 [± 0.04]
- ※ Weight : 1.7kg max
- ※ PCB Material/thickness : FR-4 / 1.6mm [0.06]
- ※ Chassis material : Aluminium
- ※ Dimensions in mm, []=inches
- ※ Mounting torque : $1.2N \cdot m$ (12.8kgf · cm) max
- ※ Screw tightening torque M4 : $1.6N \cdot m$ (16.9kgf · cm) max
- ※ M3 : $0.8N \cdot m$ (8.5kgf · cm) max

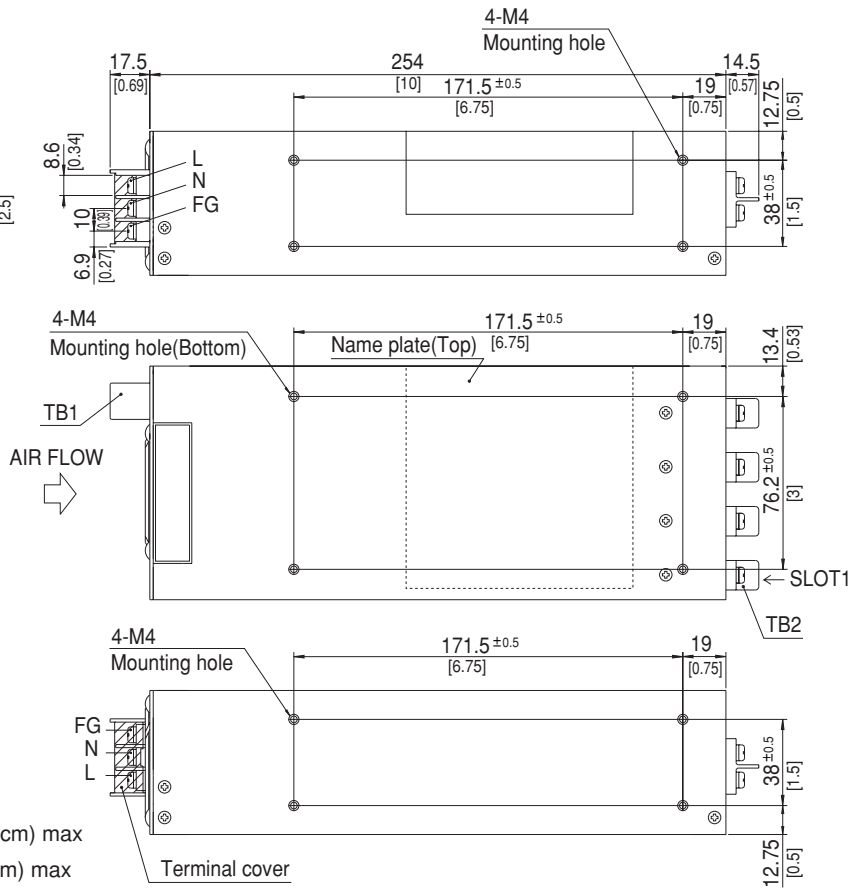

ACE450F external view

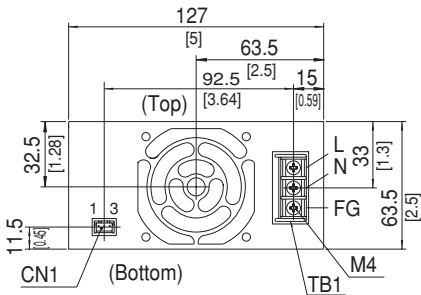

Pin connection and function of CN1

Pin No.	Function
1	G : Auxiliary power ground
2	PR : PR alarm
3	AUX : Auxiliary power (only remote ON/OFF)

Mating connector and terminal of CN1

Connector	Mating connector	Terminal	Mfr.
CN1	S3B-XH-A	XHP-3	J.S.T.
		Reel : SXH-001T-P0.6	
		Bulk : BXH-001T-P0.6	

- ※ Tolerance : ± 1 [± 0.04]
- ※ Weight : 2.2kg max
- ※ PCB Material/thickness : FR-4 / 1.6mm [0.06]
- ※ Chassis material : Aluminium
- ※ Dimensions in mm, []=inches
- ※ Mounting torque : $1.2N \cdot m$ (12.8kgf · cm) max
- ※ Screw tightening torque M4 : $1.6N \cdot m$ (16.9kgf · cm) max
- ※ M3 : $0.8N \cdot m$ (8.5kgf · cm) max

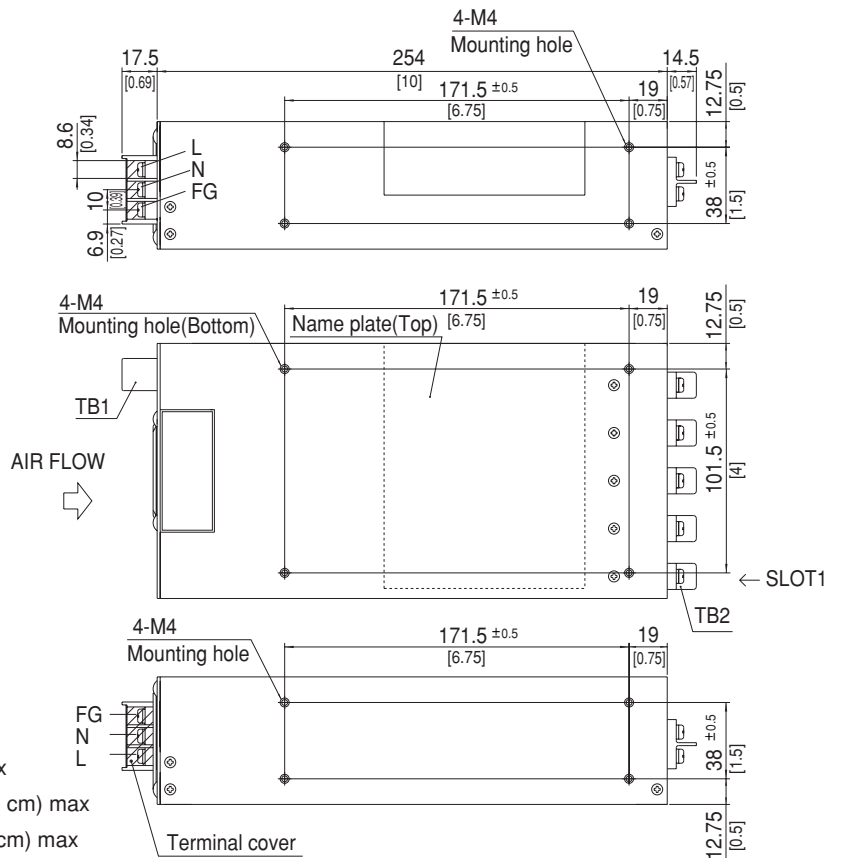

ACE650F external view

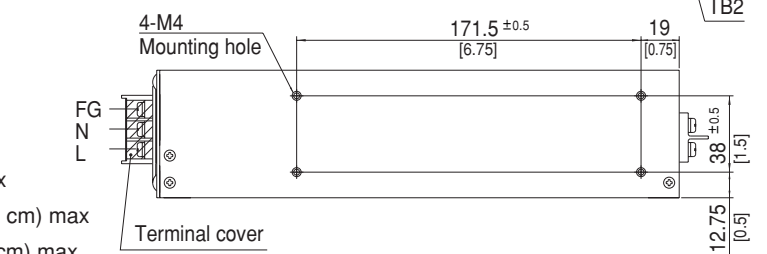

Pin connection and function of CN1

Pin No.	Function
1	G : Auxiliary power ground
2	PR : PR alarm
3	AUX : Auxiliary power (only remote ON/OFF)

Mating connector and terminal of CN1

Connector	Mating connector	Terminal	Mfr.
CN1	S3B-XH-A	XHP-3	Reel : SXH-001T-P0.6 Bulk : BXH-001T-P0.6
			J.S.T.

- ※ Tolerance : ± 1 [± 0.04]
- ※ Weight : 2.4kg max
- ※ PCB Material/thickness : FR-4 / 1.6mm [0.06]
- ※ Chassis material : Aluminium
- ※ Dimensions in mm, []=inches
- ※ Mounting torque : $1.2N \cdot m$ (12.8kgf · cm) max
- ※ Screw tightening torque M4 : $1.6N \cdot m$ (16.9kgf · cm) max
- ※ M3 : $0.8N \cdot m$ (8.5kgf · cm) max

ACE900F external view

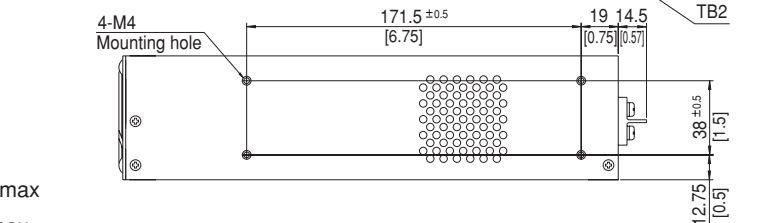
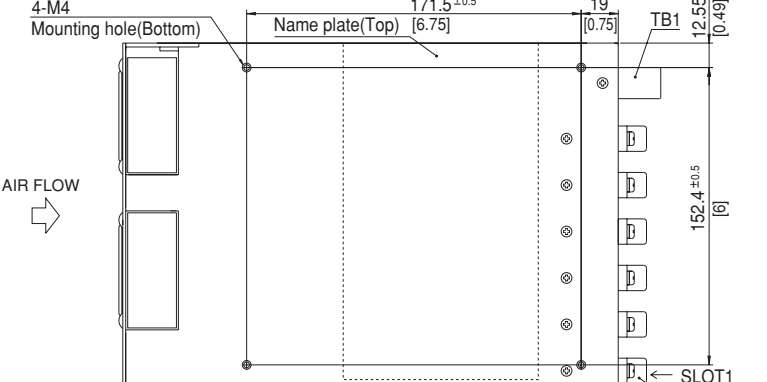
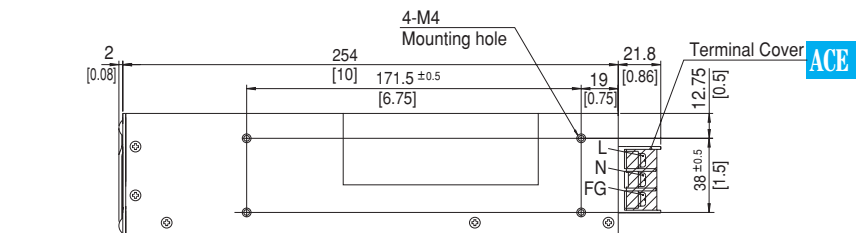
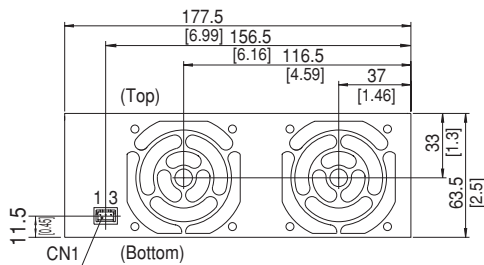

Pin connection and function of CN1

Pin No.	Function
1	G : Auxiliary power ground
2	PR : PR alarm
3	AUX : Auxiliary power (only remote ON/OFF)

Mating connector and terminal of CN1

Connector	Mating connector	Terminal	Mfr.
CN1	S3B-XH-A	XHP-3	Reel : SXH-001T-P0.6 Bulk : BXH-001T-P0.6
			J.S.T.

- ※ Tolerance : ± 1 [± 0.04]
- ※ Weight : 3kg max
- ※ PCB Material/thickness : FR-4 / 1.6mm [0.06]
- ※ Chassis material : Aluminium
- ※ Dimensions in mm, []=inches
- ※ Mounting torque : $1.2N \cdot m$ (12.8kgf · cm) max
- ※ Screw tightening torque M4 : $1.6N \cdot m$ (16.9kgf · cm) max
- ※ M3 : $0.8N \cdot m$ (8.5kgf · cm) max

Output module and connector pin assign

1. Output side view

ACE300F Output side view



ACE450F/650F Output side view



ACE900F Output side view



※Tolerance : ± 1 [± 0.04]

※Dimensions in mm, [] =inches

2. Output module side view and connector pin assign



Module : A-K,L,M,N,P,R



Module : Y,W,Z,9,Q,V



Module : 2A-2K



Module : S,T,U



※Tolerance : ± 1 [± 0.04]

※Dimensions in mm, [] =inches

Output module and connector pin assign

●CN2 connector pin assign except module S,T,U

Mating connector and terminal of CN2 in Output Module

Connector	Mating connector	Terminal	Mfr.
CN2	S10B-PHDSS	PHDR-10VS	Chain : SPHD-002T-P0.5
			Loose : BPHD-001T-P0.5 BPHD-002T-P0.5*1
			J.S.T.

※ The housing for the remote sensing unused is mounted on CN2 of each output module(applying module : A - K,2A - 2K).

*1 Please consult J.S.T for a non-standard crimping tool.



Pin connection and function of CN2 in Output Module

Pin No.	Function	
	Applying module : A - K,2A - 2K	Applying module : L,M,N,P,R,Y,W,Z,9,Q,V
1	RC+ : Remote ON/OFF +	RC+ : Remote ON/OFF +
2	RC- : Remote ON/OFF -	RC- : Remote ON/OFF -
3	N/C : N.C.	N/C : N.C.
4	N/C : N.C.	N/C : N.C.
5	LV+ : LV alarm	LV+ : LV alarm
6	LV- : LV alarm ground	LV- : LV alarm ground
7	+M : Self sensing terminal. (Do not wire for external connection.)	N/C : N.C.
8	+S : + Remote sensing	N/C : N.C.
9	-M : Self sensing terminal. (Do not wire for external connection.)	N/C : N.C.
10	-S : - Remote sensing	N/C : N.C.

●CN2 connector pin assign of module S,T,U

Mating connector and terminal of CN2 in Output Module

Connector	Mating connector	Terminal	Mfr.
CN2	S2B-PH-K-S	PHR-2	Chain:SPH-002T-P0.5S
			Loose:BPH-002T-P0.5S
			J.S.T.

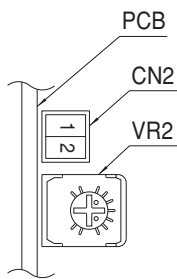

Pin connection and function of CN2 in Output Module

Pin No.	Function
1	Remote ON/OFF +
2	Remote ON/OFF -

Mouser Electronics

Authorized Distributor

Click to View Pricing, Inventory, Delivery & Lifecycle Information:

Cosel:

[AC3-2HET-00](#) [AC3-2JMW-00](#) [AC3-IZMM-00](#) [AC3-KMZD-00](#) [AC3-MERR-00](#) [AC3-MMBA-00](#) [AC9-ZNCH2H-02](#)
[AC9-ZNKKKK-00-H](#) [AC9-TK2D2H-00](#) [AC9-TQ2J2J-00-FGW](#) [AC9-VEKKKK-00](#) [AC9-WY2H2B-00](#) [AC9-Z2J2JK-04-K](#)
[AC9-ZDUUHH-00-01](#) [AC9-NP2H2H-00](#) [AC9-O2EJJJ-00](#) [AC9-ORMW2K-00-H](#) [AC9-PPCH2H-00](#) [AC9-PWMH2H-00](#)
[AC9-R9HVWM-00-CU](#) [AC9-HV2J2J-02](#) [AC9-MB2D2D-02-T](#) [AC9-MH2H2H-00-02](#) [AC9-MN2H2H-00-02](#) [AC9-](#)
[MVHF2F-00](#) [AC9-NN2H2H-00](#) [AC9-DDDDDD-00-1B](#) [AC9-E2HHKK-04](#) [AC9-EE2C2C-02-10](#) [AC9-HEEKKK-03-H](#)
[AC9-HHHHHH-1B](#) [AC9-HS2D2D-02](#) [AC9-9VMH2H-02](#) [AC9-9Z2H2H-02-W](#) [AC9-BCDDNH-00](#) [AC9-BE2E2E-00-](#)
[H02K](#) [AC9-CC2C2B-08-CT](#) [AC9-CCCC2C-02-08CT](#) [AC9-2H2H2H-00-G](#) [AC9-2H2H2H-0A-H](#) [AC9-2H2H2H-0A-HK](#)
[AC9-2J2J2J-00](#) [AC9-2K2K2K-00](#) [AC9-999999-00](#) [AC9-2A2A2A-0A](#) [AC9-2D2D2E-08-CT](#) [AC9-2E2EEH-00](#) [AC9-](#)
[2EECBO-00-H](#) [AC9-2H2F2F-00](#) [AC9-2H2H2H-00](#) [AC6-PPNHC-00](#) [AC6-RMF2B-00](#) [AC6-TEC2C-02](#) [AC6-THC2D-00](#)
[AC6-ZBC2H-00](#) [AC6-ZFF2D-00](#) [AC6-OGGGG-00-F](#) [AC6-OGGGG-07](#) [AC6-OHHHH-00-F](#) [AC6-OJJJJ-00-F](#) [AC6-](#)
[OME2H-00-HG](#) [AC6-OZW2C-00](#) [AC6-O2J2J-00](#) [AC6-OEC2H-00](#) [AC6-OEE2C-00](#) [AC6-OEE2H-00](#) [AC6-OFF2F-06-](#)
[CT](#) [AC6-OFF2J-00-EFW](#) [AC6-O2G2G-02-CT](#) [AC6-O2H2E-00](#) [AC6-O2H2H-00](#) [AC6-O2H2H-00-C](#) [AC6-O2H2K-00](#)
[AC6-O2H2K-00-C](#) [AC6-MZE2H-00](#) [AC6-NEM2C-00](#) [AC6-O2C2C-02-R](#) [AC6-O2E2E-00-02](#) [AC6-O2E2E-00-H02](#)
[AC6-O2E2E-02](#) [AC6-IEE2C-00](#) [AC6-JJJJJ-00](#) [AC6-K2H2H-00](#) [AC6-KKKKK-00](#) [AC6-L2K2K-00-F](#) [AC6-MEJ2H-00-C](#)
[AC6-EC92H-00-EFW](#) [AC6-EEEE-00](#) [AC6-FFC2C-02](#) [AC6-FFFF-00](#) [AC6-GGGGG-00](#) [AC6-HHHHH-00](#) [AC4-](#)
[RPP2C-00](#) [AC4-WNCB9-00](#) [AC6-2H2JK-00](#) [AC6-CCCC-00](#) [AC6-E2E2C-08-HG](#) [AC6-E2E2C-08-HGW](#) [AC4-](#)
[OVE2C-00](#) [AC4-OYE2E-02](#)

Компания «Океан Электроники» предлагает заключение долгосрочных отношений при поставках импортных электронных компонентов на взаимовыгодных условиях!

Наши преимущества:

- Поставка оригинальных импортных электронных компонентов напрямую с производств Америки, Европы и Азии, а так же с крупнейших складов мира;
- Широкая линейка поставок активных и пассивных импортных электронных компонентов (более 30 млн. наименований);
- Поставка сложных, дефицитных, либо снятых с производства позиций;
- Оперативные сроки поставки под заказ (от 5 рабочих дней);
- Экспресс доставка в любую точку России;
- Помощь Конструкторского Отдела и консультации квалифицированных инженеров;
- Техническая поддержка проекта, помощь в подборе аналогов, поставка прототипов;
- Поставка электронных компонентов под контролем ВП;
- Система менеджмента качества сертифицирована по Международному стандарту ISO 9001;
- При необходимости вся продукция военного и аэрокосмического назначения проходит испытания и сертификацию в лаборатории (по согласованию с заказчиком);
- Поставка специализированных компонентов военного и аэрокосмического уровня качества (Xilinx, Altera, Analog Devices, Intersil, Interpoint, Microsemi, Actel, Aeroflex, Peregrine, VPT, Syfer, Eurofarad, Texas Instruments, MS Kennedy, Miteq, Cobham, E2V, MA-COM, Hittite, Mini-Circuits, General Dynamics и др.);

Компания «Океан Электроники» является официальным дистрибьютором и эксклюзивным представителем в России одного из крупнейших производителей разъемов военного и аэрокосмического назначения «**JONHON**», а так же официальным дистрибьютором и эксклюзивным представителем в России производителя высокотехнологичных и надежных решений для передачи СВЧ сигналов «**FORSTAR**».



JONHON

«**JONHON**» (основан в 1970 г.)

Разъемы специального, военного и аэрокосмического назначения:

(Применяются в военной, авиационной, аэрокосмической, морской, железнодорожной, горно- и нефтедобывающей отраслях промышленности)

«**FORSTAR**» (основан в 1998 г.)

ВЧ соединители, коаксиальные кабели,
кабельные сборки и микроволновые компоненты:

(Применяются в телекоммуникациях гражданского и специального назначения, в средствах связи, РЛС, а так же военной, авиационной и аэрокосмической отраслях промышленности).



Телефон: 8 (812) 309-75-97 (многоканальный)

Факс: 8 (812) 320-03-32

Электронная почта: ocean@oceanchips.ru

Web: <http://oceanchips.ru/>

Адрес: 198099, г. Санкт-Петербург, ул. Калинина, д. 2, корп. 4, лит. А