

925-093 to 925-299

31/32



Description

General Notes

The series 31 illuminated pushbuttons are equipped with snap-action or low-level switching elements.

For technical data see pages 2-4.

In addition to the standard contacts (gold-plated silver), silver contacts can also be ordered. The front dimensions of these units are 18 x 24 mm or 18 mm dia.

In addition to a number of illuminated pushbuttons, the customer can choose from a wide range of other units and accessories having the same front and mounting dimensions: indicators, keylock switches, flashers, segment displays, buzzers, illuminated pushbuttons with microfuse, etc. (For keylock switches see series 51 or 61.)

Mounting

Mounting from the front through the mounting hole is assured even when the wiring has already been attached (mounting dimensions and spacing see pages 5-7).

The universal terminals of the low-level switching elements permit mounting on printed circuit boards (PCB).

These terminals are also suitable for dip soldering. For these terminals we can also supply a plug-in base which, when soldered on to the board, enables the switch to be plugged in. All rectangular switches, as well as the square and round keylock switches are secured against rotation.

Lenses

The flat or concave lenses, made of polymethyl methacrylate, are obtainable in various colours, as well as translucent or transparent.

Marking

For engravings, hot stamping and film inserts, see under "Marking" on page 29.

Illumination

Perfect illumination of the different coloured lenses is assured by midget-grooved lamps T 1¼ (6-60 V).

If the supply voltage is above 60 V, an external dropping resistor or capacitor must be used. Multi-LED midget-grooved lamps T 1¼ (6, 12, 24, 48 V) are available in the colours red, yellow and green.

Due to the high surface temperature, resistors may not be soldered direct to the terminals of the pushbuttons.

See under "Lamp accessories" on page 22.

Position indication

When a switch with maintained action is actuated, the lens remains in the depressed position mechanically. The state of the switch is apparent at all times from the position of the lens.

How to order

31-XXX.0XX



31-9XX.X

Lens

Example:

- Illuminated pushbutton, round, with momentary action; gold-plated silver contact; 1 switching element
31-131.025
- Lens, red
31-933.2

All dimensions in mm.

We reserve the right to modify technical data.

Snap-action switching element with soldering terminals at the sides



These elements can be stacked up to 4 elements per button.

Indicator .005/.805
 Illuminated pushbuttons and keylock switches with snap-action switching elements:
 – gold-plated silver contacts .025/.825
 – silver contacts, suitable for over 20 V .015/.815

Snap-action switching element with axial plug-in/soldering terminals 2,8 mm



These elements cannot be stacked, hence only one element per button.

Indicator .002/.802
 Illuminated pushbuttons and keylock switches with snap-action switching elements:
 – gold-plated silver contacts .022/.822
 – silver contacts, suitable for over 20 V .012/.812

Switching system

Self-cleaning, double-break, snap-action switching system. Can be used as double-throw switch with one normally closed or one normally open contact per element.

Contact material

- gold-plated silver
- silver, suitable for over 20 V

Travel

3 mm

Actuating force (measured at the lens)

2–5,5 N (200–550 g), depending on the number of switching elements

Switch rating

250 VAC, 5 A (p. f. = 1)
 250 VAC, 3 A (p. f. = 0,3)

Switch rating AC, p. f. 0,7 as per AC 11 (IEC 337)

Voltage V	125	250
Current A	3	2

Switch rating DC (inductive), L : R = 30 ms as per DC 11 (IEC 337)

Voltage V	24	60	110	220
Current A	2	0,7	0,2	0,1

Continuous current

I_{th} 5 A.
 The maximum permissible current in continuous operation and at ambient temperature not exceeding the quoted maximum values.

Mechanical life

2 million operations

Rated insulation voltage

250 VAC/DC as per VDE 0110, Group B

Electric strength

2500 VAC, 50 Hz, 1 min between all terminals and earth, as per IEC 512-2-11.

Terminals

Snap-action element with soldering terminals at the sides:
 Max. wire diameter: 2 wires of 0,8 mm each
 Max. wire cross-section of stranded cable: $1 \times 0,75 \text{ mm}^2$
 Snap-action element with axial plug-in terminals which can also be used as soldering terminals.
 Plug-in terminals: $2,8 \times 0,5 \text{ mm}$
 Soldering terminal: max. wire diameter: 2 wires of 1 mm each
 Max. wire cross-section of stranded cable: $2 \times 0,75 \text{ mm}^2$

Ambient temperature

–25 °C to +55 °C

For indicators and illuminated pushbuttons mounted as a block, make sure the heat can escape freely.

Storage temperature

–40 °C to +85 °C

Switching system

This low-level switching element was designed for switching low powers in electronic circuits. The mechanism assures reliable switching of loads ranging from a few $\mu\text{A}/\mu\text{V}$ up to 100 mA/42 VAC/VDC. Single-break momentary contact, as normally open or normally closed with 4 independent points of contact.
2 momentary contacts per switching element; combination of normally open and normally closed is possible.
Special features are the long life, extremely short rebound time and stable contact resistance.

Contact material

gold-plated

Travel

3 mm

Actuating force (measured at the lens)

3–3,5 N (300–350 g)

Switch rating

10 $\mu\text{A}/100 \mu\text{V}$ to 100 mA at 42 VAC/VDC

Contact resistance

Value as new $\leq 50 \text{ m}\Omega$

Rebound time

typical $< 100 \mu\text{s}$

Mechanical life

5 million operations

Electric strength

2500 VAC, 50 Hz, 1 min between all terminals and earth, as per IEC 512-2-11.

Terminals

The universal terminals permit these units to be mounted on printed circuit boards (PCB). These terminals can also be used as soldering or plug-in terminals. For these terminals we can also supply a plug-in base which, when soldered on to the board, enables the switch to be plugged in.

Max. wire diameter: 2 wires of 0,8 mm each

Max. wire cross-section of stranded cable: $1 \times 0,75 \text{ mm}^2$

Plug-in terminals: $2,0 \times 0,5 \text{ mm}$

Ambient temperature

$-25 \text{ }^\circ\text{C}$ to $+55 \text{ }^\circ\text{C}$

For indicators and illuminated pushbuttons mounted as a block, make sure the heat can escape freely.

Storage temperature

$-40 \text{ }^\circ\text{C}$ to $+85 \text{ }^\circ\text{C}$

Shockproof (single impact, semi-sinusoidal)

15 g for 11 ms as per IEC 68-2-27

Actuator case

Made of polytherimide, self-extinguishing

Switch case

Made of polysulfon, heat-resistant and self-extinguishing

Degree of protection of front as per IEC 529

IP 40

IP 67 with sprayproof cover

Switching function (colour code)

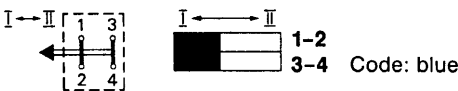

Terminals



PCB layout conductor side



Resistance to vibration (sinusoidal)

10 g at 10–2000 Hz, amplitude 1,5 mm as per IEC 68-2-6

Shockproof (single impacts, semi-sinusoidal)

15 g for 11 ms as per IEC 68-2-27

Actuator case

Made of polytherimide, self-extinguishing

Switch case

DAP (diallyl phthalate), heat-resistant and self-extinguishing

Degree of protection of front as per IEC 529

IP 40

IP 67 with sprayproof cover

Approvals

– SEV 250 VAC/5 A

– CSA 300 VAC

– Lloyd's Marine Register

– UL

– Germanischer Lloyd

– NEMKO

– ÖVE

– Russian Marine Register

– VDE

Dimensions refer to page 9

Indicator, illuminated pushbuttons

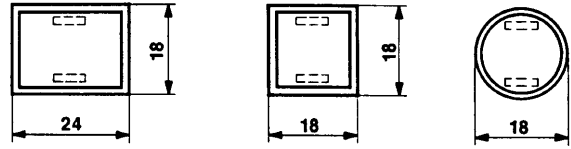

Snap-action switching element

Dimensions refer to page 10

Indicator, illuminated pushbuttons

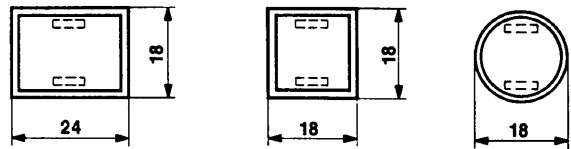

Diode matrix "M"

Dimensions refer to pages 12 + 13

Indicator, illuminated pushbuttons

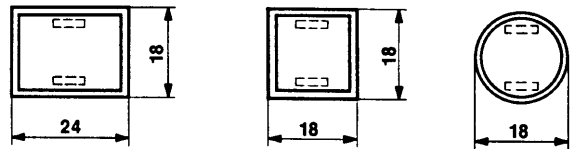

Low-level "LL"

Dimensions refer to page 19



Snap-action switching element

Keylock switches

Series 32

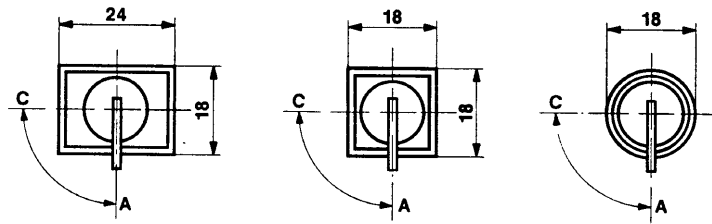

Dimensions refer to page 14

Buzzer

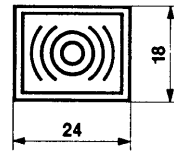

Dimensions refer to page 15

Buzzer

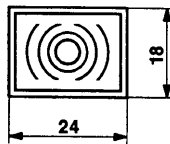

Dimensions refer to page 16

Segmental display



Dimensions refer to page 18

Illuminated pushbutton with microfuse



Indicators, illuminated pushbuttons

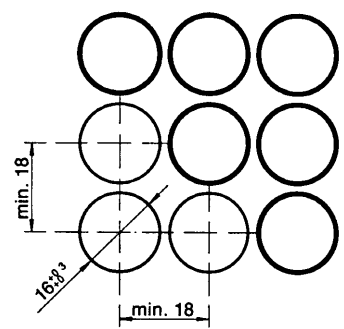
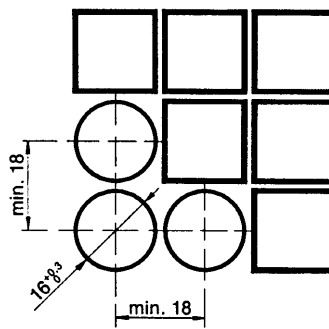
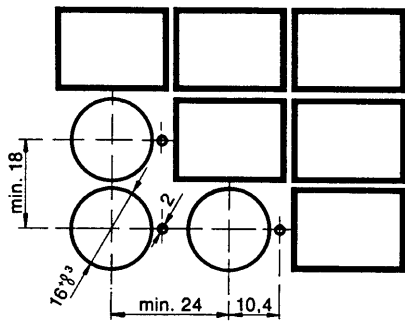

Keylock switches series 32

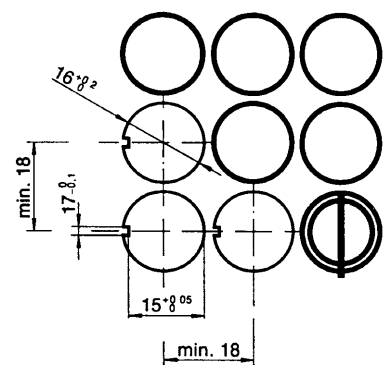
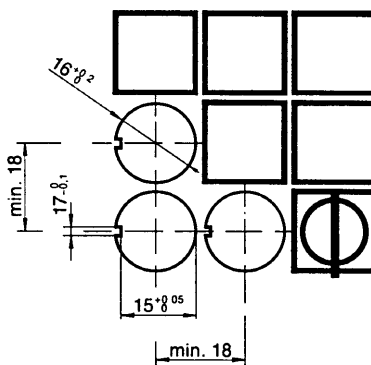
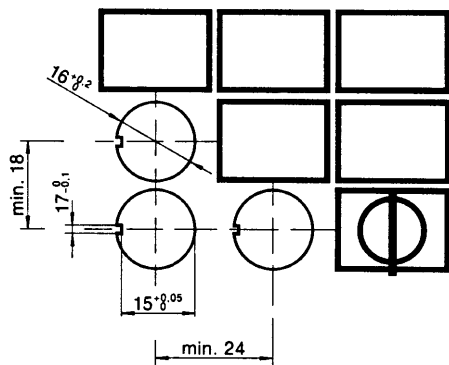

Indicator, Illuminated Pushbuttons with Snap-action Switching Element



250 VAC, 5 A

Dimensions see page 5

Order lenses separately
see page 20

- 18 x 24 mm
- 18 x 18 mm
- 18 mm

Description	Momentary action	Maintained action	Type No.	Terminals			Depth mm with soldering terminals	Depth mm with plug-in terminals
				Case colour	Contact material	Terminals		
Indicator	-	-	 □ 31-040. ▽ 31-050. ∅ 31-030.	0	0		23,5	26,5
Illuminated pushbutton 1 switching element	x	-	 □ 31-121. ▽ 31-151. ∅ 31-131.	0			29	36
Illuminated pushbutton 2 switching elements	x	-	 □ 31-122. ▽ 31-152. ∅ 31-132.	0	5		36,5	
Illuminated pushbutton 3 switching elements	x	-	 □ 31-123. ▽ 31-153. ∅ 31-133.	0	5		44	
Illuminated pushbutton 4 switching elements	x	-	 □ 31-124. ▽ 31-154. ∅ 31-134.	0	5		51,5	
Illuminated pushbutton 1 switching element	-	x	 □ 31-261. ▽ 31-281. ∅ 31-271.	0			29	36
Illuminated pushbutton 2 switching elements	-	x	 □ 31-262. ▽ 31-282. ∅ 31-272.	0	5		36,5	
Illuminated pushbutton 3 switching elements	-	x	 □ 31-263. ▽ 31-283. ∅ 31-273.	0	5		44	
Illuminated pushbutton 4 switching elements	-	x	 □ 31-264. ▽ 31-284. ∅ 31-274.	0	5		51,5	

Silver = 1, gold-plated silver = 2
 Plug-in terminals 2,8 x 0,5 mm = 2, soldering terminals = 5

For lamps see page 21

Indicator, Illuminated Pushbuttons with Snap-action Switching Element and Diodes (1 N 4007)

31 M



250 VAC, 5 A

Dimensions see page 5

Order lenses separately
see page 20

-  18 x 24 mm
-  18 x 18 mm
-  18 mm

Description	Number of diodes	Momentary action	Maintained action	Type No.	Case colour			Depth mm
					Case colour	Contact material	Terminals	
Indicator with diodes	1	-	-	 31-701.	0	0	6	36
				 31-703.	0	0	6	
				 31-741.	0	0	6	
Indicator with diodes	2	-	-	 31-702.	0	0	6	36
				 31-704.	0	0	6	
				 31-742.	0	0	6	
Illuminated pushbutton 1 switching element and diodes	1	x	-	 31-705.	0	2	9	43,5
				 31-709.	0	2	9	
				 31-743.	0	2	9	
Illuminated pushbutton 1 switching element and diodes	2	x	-	 31-706.	0	2	9	43,5
				 31-710.	0	2	9	
				 31-744.	0	2	9	
Illuminated pushbutton 2 switching elements and diodes	1	x	-	 31-707.	0	2	9	51
				 31-711.	0	2	9	
				 31-745.	0	2	9	
Illuminated pushbutton 2 switching elements and diodes	2	x	-	 31-708.	0	2	9	51
				 31-712.	0	2	9	
				 31-746.	0	2	9	
Illuminated pushbutton 1 switching element and diodes	1	-	x	 31-713.	0	2	9	43,5
				 31-717.	0	2	9	
				 31-747.	0	2	9	
Illuminated pushbutton 1 switching element and diodes	2	-	x	 31-714.	0	2	9	43,5
				 31-718.	0	2	9	
				 31-748.	0	2	9	
Illuminated pushbutton 2 switching elements and diodes	1	-	x	 31-715.	0	2	9	51
				 31-719.	0	2	9	
				 31-749.	0	2	9	
Illuminated pushbutton 2 switching elements and diodes	2	-	x	 31-716.	0	2	9	51
				 31-720.	0	2	9	
				 31-750.	0	2	9	

For lamps see page 21

Indicator, Illuminated Pushbuttons with Low-level Switching Element



31 LL































Dimensions see page 5

42 VAC/VDC, 100 mA

Order lenses separately
see page 20

-  18 x 24 mm
-  18 x 18 mm
-  18 mm

Description	Momentary action	Maintained action		Type No.				Depth mm
					Case colour	Contact material	Terminals	
Indicator (The total length is the same as that of the illuminated pushbutton)	-	-		 31-041.  31-051.  31-031.	0	0	6	36
Illuminated pushbutton 1 normally open contact	x	-	 	 31-425.  31-455.  31-435.	0	3	6	36
Illuminated pushbutton 2 normally open contacts	x	-	 	 31-421.  31-451.  31-431.	0	3	6	36
Illuminated pushbutton 1 normally closed contact	x	-	 	 31-426.  31-456.  31-436.	0	3	6	36
Illuminated pushbutton 2 normally closed contacts	x	-	 	 31-422.  31-452.  31-432.	0	3	6	36
Illuminated pushbutton 1 normally closed contact 1 normally open contact	x	-	 	 31-423.  31-453.  31-433.	0	3	6	36

For lamps see page 21

With indicators and illuminated pushbuttons equipped with diodes, the user is able to perform a lamp check

or wire an alarm circuit simply with a considerable saving of space.

Applications:

Lamp check

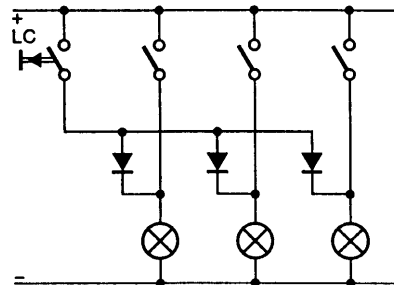

Lamp check with blocking diodes

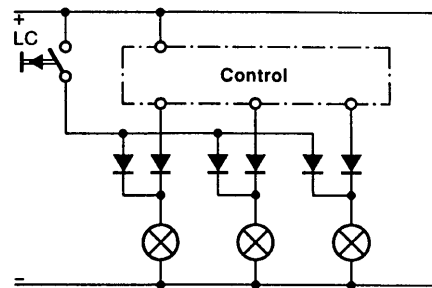

Alarm circuit from fault annunciating system

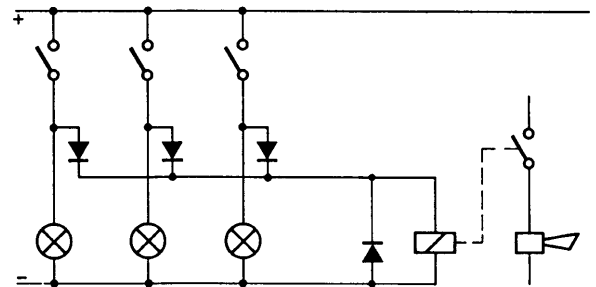

Lamp check and alarm circuit

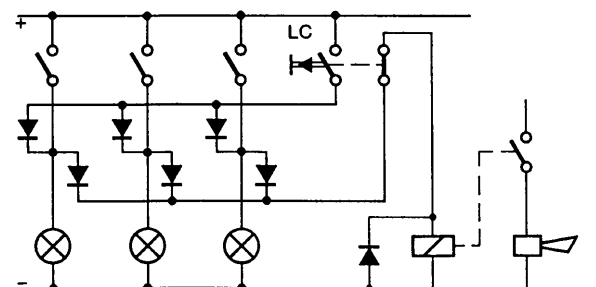

Lamp check and alarm circuit with only one diode and AC voltage

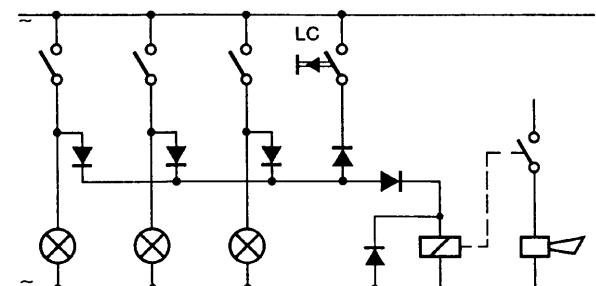

LC = Lamp check

Indicator, Illuminated Pushbuttons with Low-level Switching Element

31 LL

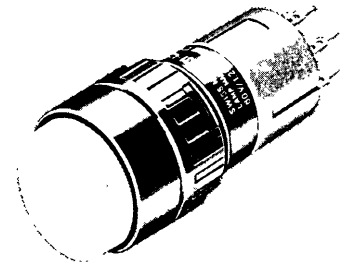

Dimensions see page 5

42 VAC/VDC, 100 mA
Order lenses separately
see page 20

- 18 x 24 mm
- 18 x 18 mm
- 18 mm

Description	Momentary action	Maintained action		Type No.				Depth mm
					Case colour	Contact material	Terminals	
Illuminated pushbutton 1 normally open contact	-	x		31-465.	0	3	6	36
				31-485.	0	3	6	
				31-475.	0	3	6	
Illuminated pushbutton 2 normally open contacts	-	x		31-461.	0	3	6	36
				31-481.	0	3	6	
				31-471.	0	3	6	
Illuminated pushbutton 1 normally closed contact	-	x		31-466.	0	3	6	36
				31-486.	0	3	6	
				31-476.	0	3	6	
Illuminated pushbutton 2 normally closed contacts	-	x		31-462.	0	3	6	36
				31-482.	0	3	6	
				31-472.	0	3	6	
Illuminated pushbutton 1 normally closed contact 1 normally open contact	-	x		31-463.	0	3	6	36
				31-483.	0	3	6	
				31-473.	0	3	6	

For lamps see page 21



Dimensions see page 6

 18 x 24 mm

Description		Type No.	Depth mm
Buzzer, continuous and intermittent tone	10-26 VDC	31-801.002	36

(-) a — b (+) Continuous tone
 (+) a b (-) Intermittent tone



Technical data

Acoustic data

Sound pressure 95 db ± 5 at a distance of 0,1 m
 Sound frequency approx. 2,0 kHz
 Interval frequency 4 Hz

Electrical data

Operating voltage: 10-26 VDC
 Working current: ≤ 30 mA

Mechanical data

Dimensions of front: 18 x 24 mm
 Mounting hole: 16 mm dia.
 Back panel depth: 36 mm
 Terminals: Plug-in terminals 2,8 x 0,5 mm
 Degree of protection: IP 40 as per IEC 529

Materials

Case: polyetherimide, self-extinguishing
 Storage and operating temperature: -25 °C to +55 °C

Application



Depending on how the terminals are connected, the buzzer can operate with a continuous tone a(-) b(+) or with intermittent tone a(+) b(-).

Note: For mounting on PCB use plug-in base 31-942.



Dimensions see page 6

18 x 24 mm

Description		Type No.	Depth mm
Buzzer, continuous and intermittent tone	10-55 VAC 10-75 VDC	31-810.005	67



Technical data

Sound pressure

90 db ± 5 at a distance of 0,1 m
Volume variable with a 1 MΩ/potentiometer or corresponding fixed resistor.

Frequency (tone)

appr. 2,8 kHz

Supply voltage I



Supply voltage II



Current consumption

typical 25 mA AC
typical 15 mA DC

Typical applications

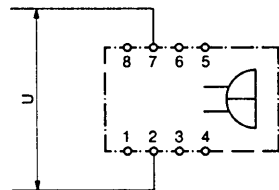

1. Supply voltage I
Continuous tone
U = 10-35 VAC
U = 10-50 VDC

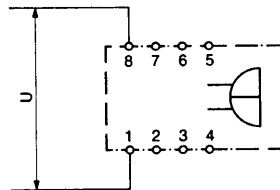

2. Supply voltage II
Continuous tone
U = 35-55 VAC
U = 35-75 VDC

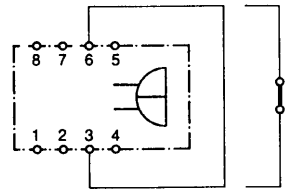

3. Intermittent tone
Interval appr. 3 Hz

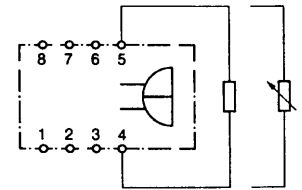

4. Volume control

Ambient temperature

-25 °C to +55 °C

Storage temperature

-40 °C to +85 °C

System

- Contactless electronic buzzer
- With IC oscillator

Features

- Low power consumption
- Wide voltage range
- No mechanical contacts
- Rugged construction



Dimensions see page 7

18 x 24 mm

Description	Connections	Type No.	Case colour	Contact material	Terminals	Depth mm
			0	0	5	
<p>This segmental display contains a seven-segment GA-P element including decimal point with common anode. It should be energized with current limitation in 7-segment code (e.g. switch, semiconductor driver).</p>		31-022.	0	0	5	39
<p>This segmental display contains a seven-segment GA-P element including decimal point with common cathode. It should be energized with current limitation in 7-segment code (e.g. switch, semiconductor driver).</p>		31-023.	0	0	5	39

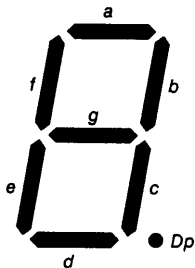

Connections for DIL base



Segmental Display (7-segment)

31 D

Technical data $T_a = 25^\circ\text{C}$

	symbol	min.	typ.	max.	unit	conditions
Continuous current	I_F			15	mA	per segment, Dp
Pulse current	I_{FP}			80	mA	$P_W = 1 \text{ ms}$, $DF = 1/10$
Forward voltage	V_F	1.8	1.9	2.4	V	$I_F = 15 \text{ mA}$
Blocking voltage	BV_R			3	V	$I_R = 5.0 \mu\text{A max.}$
Light intensity	I_V	0.04	0.11		mcd	$I_F = 5 \text{ mA}$
Power loss	P_D			350	mW	7 Segm. + Dp
Temp. coeff. of V_F	TC_{VF}		-2		mV/ $^\circ\text{C}$	
Ambient temperature	T_a	-20		+75	$^\circ\text{C}$	



Pulse duration P_W (ms)
 $DF = \text{duty cycle} = \frac{\text{pulse duration}}{\text{cycle duration}}$

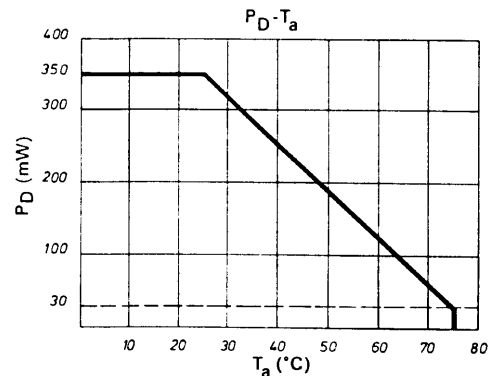

Illuminated Pushbutton with Microfuse and Snap-action Switching Element

31

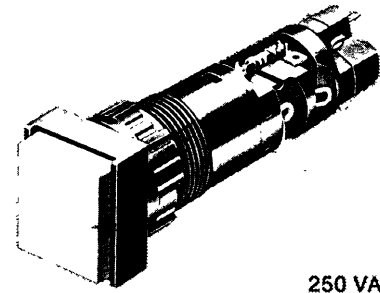

250 VAC, 5 A

Dimensions see page 7

Order lenses separately
see page 20

□ 18 x 18 mm

Description	Lamp voltage	Maintained action	Type No.	Case colour	Contact material	Terminals	Depth mm
Separate circuits between microfuse and lamp Illuminated pushbutton 1 switching element	6- 60 V	x	31-201.	0	2	5	56,5
	6- 60 V	x	31-202.	0	2	5	64
Operating indicator Lamp goes out when fuse blows Illuminated pushbutton 1 switching element	6- 60 V	x	31-207.	0	2	5	56,5
	6- 60 V	x	31-208.	0	2	5	64
Interruption indicator Lamp lights when fuse blows Illuminated pushbutton 1 switching element	6- 60 V	x	31-213.	0	2	5	56,5
	6- 60 V	x	31-214.	0	2	5	64

Technical data

- Microfuse: 5 dia. x 20 mm
- Rated voltage: max. 250 V
- Rated current: max. 6,3 A fast

For lamps see page 21

Illuminated Pushbutton with Microfuse and Snap-action Switching Element

31



250 VAC, 5 A

Dimensions see page 7

Order lenses separately
see page 20

□ 18 × 18 mm

Description	Lamp voltage	Maintained action	Type No.	Case colour	Contact material	Terminals	Depth mm
Separate circuits between microfuse and lamp Illuminated pushbutton 1 switching element	6- 60 V	x	31-201.	0	2	5	56,5
	6- 60 V	x	31-202.	0	2	5	64
Operating indicator Lamp goes out when fuse blows Illuminated pushbutton 1 switching element	6- 60 V	x	31-207.	0	2	5	56,5
	6- 60 V	x	31-208.	0	2	5	64
Interruption indicator Lamp lights when fuse blows Illuminated pushbutton 1 switching element	6- 60 V	x	31-213.	0	2	5	56,5
	6- 60 V	x	31-214.	0	2	5	64

Technical data

- Microfuse: 5 dia. x 20 mm
- Rated voltage: max. 250 V
- Rated current: max. 6,3 A fast

For lamps see page 21

Keylock Switches (IP 40) with Snap-action Switching Element

32



Dimensions see page 6

Description	Key removable in position			Type No.	Case colour			Depth mm
		A	C		Material	Terminals		
Keylock switch Position A basic position Position C maintained action 1 switching element		A	C	32-195. 32-155. 32-135.	0	1	2	36
		A		32-295. 32-255. 32-235.	0	1	2	
			C	32-395. 32-355. 32-335.	0	1	2	
Silver = 1 Plug-in terminals 2,8 x 0,5 mm = 2								

Description	Colour	 15,2 x 21,2 mm	 15,2 x 15,2 mm	 15,8 mm			
	● opaque	Type No.	Type No.	Type No.			
Flat, translucent lens with translucent support	● black	31-901.0	31-951.0	31-931.0			
	red	31-901.2	31-951.2	31-931.2			
	orange	31-901.3	31-951.3	31-931.3			
	yellow	31-901.4	31-951.4	31-931.4			
	green	31-901.5	31-951.5	31-931.5			
	blue	31-901.6	31-951.6	31-931.6			
	● grey	31-901.8	31-951.8	31-931.8			
	white	31-901.9	31-951.9	31-931.9			
	Concave, translucent lens with translucent support	● black	31-902.0	31-952.0			
		red	31-902.2	31-952.2			
orange		31-902.3	31-952.3				
yellow		31-902.4	31-952.4				
green		31-902.5	31-952.5				
blue		31-902.6	31-952.6				
● grey		31-902.8	31-952.8				
white		31-902.9	31-952.9				
Flat, transparent lens with translucent support (for film insert and LED)		smoked	31-903.1	31-953.1	31-933.1		
		red	31-903.2	31-953.2	31-933.2		
	orange	31-903.3	31-953.3	31-933.3			
	yellow	31-903.4	31-953.4	31-933.4			
	green	31-903.5	31-953.5	31-933.5			
	blue	31-903.6	31-953.6	31-933.6			
	clear	31-903.7	31-953.7	31-933.7			
	Concave, transparent lens with translucent support (for film insert and LED)	red	31-904.2	31-954.2			
orange		31-904.3	31-954.3				
yellow		31-904.4	31-954.4				
green		31-904.5	31-954.5				
blue		31-904.6	31-954.6				
clear		31-904.7	31-954.7				
Flat, transparent lens with transparent support		red	31-905.2	31-955.2	31-935.2		
	yellow	31-905.4	31-955.4	31-935.4			
	green	31-905.5	31-955.5	31-935.5			
	clear	31-905.7	31-955.7	31-935.7			
Concave, transparent lens with transparent support	red	31-906.2	31-956.2				
	yellow	31-906.4	31-956.4				
	green	31-906.5	31-956.5				
	clear	31-906.7	31-956.7				

Description	Lamp voltage	Power consumption	Type No.	
Filament lamp midget-grooved T1¼	6,3 V 14 V 28 V 36 V 48 V 60 V	200 mA 80 mA 40 mA 30 mA 25 mA 20 mA	31-963.0 31-963.1 31-963.2 31-963.5 31-963.3 31-963.4	
Multi-LED midget-grooved T1¼ (6 chips) with built-in blocking diode	6 V 12 V 24 V 48 V	45 mA red yellow green 25 mA red yellow green 12,5 mA red yellow green 12,5 mA red yellow green	31-968.02 31-968.04 31-968.05 31-968.12 31-968.14 31-968.15 31-968.22 31-968.24 31-968.25 31-968.42 31-968.44 31-968.45	
Recommended: transparent lens with translucent support should be used				
(Lamp connection a = cathode)				

Description		Type No.	
Series resistor to reduce the lamp voltage. Use with 60 V/20 mA lamp rating	110 V 2,7 kΩ 125 V 3,3 kΩ 145 V 4,7 kΩ 230-240 V 10 kΩ	02-904.0 02-904.1 02-904.3 02-904.7	
Capacitor to reduce the lamp voltage. Use with 60 V/20 mA lamp rating, 50 Hz	230 V 0,27 μF	02-917.0	
Empty terminal plate for wiring resistors or capacitors	5 spaces 10 spaces 15 spaces 20 spaces	02-912.1 02-912.2 02-912.3 02-912.4	
Terminal plate fitted with resistors or capacitors	2,7 kΩ 110/60 V 5 spaces 10 spaces 15 spaces 20 spaces 3,3 kΩ 125/60 V 5 spaces 10 spaces 15 spaces 20 spaces 10 kΩ 230-240/60 V 5 spaces 10 spaces 15 spaces 20 spaces 0,27 μF 230/60 V 5 spaces 10 spaces 15 spaces 20 spaces	02-913.10 02-913.20 02-913.30 02-913.40 02-913.11 02-913.21 02-913.31 02-913.41 02-913.17 02-913.27 02-913.37 02-913.47 02-914.10 02-914.20 02-914.30 02-914.40	

Description		Type No.		
Hinged, transparent protective cover with means of sealing (to prevent unauthorized operation of the lens)	square	31-920		
	rectangular	01-925		
				
Two-part sprayproof cover enabling the lamp to be replaced without problems (protection IP 67)	square membrane of PVC	31-923		
	rectangular membrane of silicone	31-924.2		
				
Protective guard, matt chromium-plated (with the narrow ends bent upwards) (with the broad sides bent upwards)		01-926 01-927		
				
Blind plugs	rectangular 18 x 24 mm	black grey	01-947.0 01-947.8	
	square 18 x 18 mm	black grey	01-948.0 01-948.8	
	circular 18 mm dia.	black grey	01-949.0 01-949.8	

Description	Type No.
<p>AML adaptor for American panel cutout</p>  <p>square</p>	<p>31-948</p> 
 <p>rectangular</p>	<p>31-949</p> 
<p>Insulation socket for axial snap-action switching element 2,8 mm, to cover the plug-in terminals</p>	<p>01-928</p> 
<p>Terminal cover for snap-action switching element</p>	<p>01-929</p> 

Description

Type No.

Axial PCB plug-in base for low-level switching elements
16,4 mm dia. x 9,8 mm high



31-940



Right-angled PCB plug-in base for low-level switching elements
17,9 mm square x 8,4 mm high

The withdrawable mounting pins allow the distance between the PCB plug-in base and the board to be varied by up to 3 mm



31-941

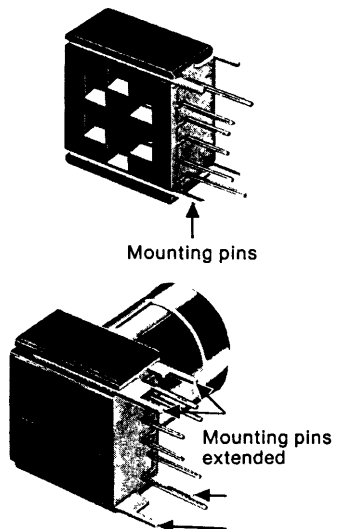

Axial PCB plug-in base for axial snap-action switching element 2,8 mm
17,8 mm dia. x 9,8 mm high

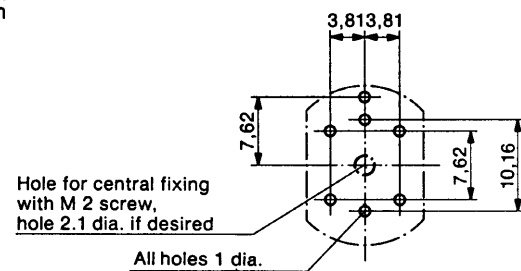

31-942

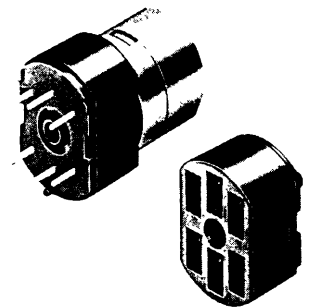

Plug-in adapter with screw connection for switches with plug-in terminal 2,8 x 0,5 mm

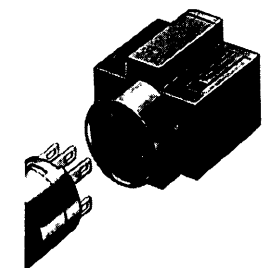

The screw connections can be applied for 2 wires each 1 mm Ø or 2 standard wires each 0,75 mm².
The use of the plug-in adapter increases the back panel depth by 14 mm compared to the standard switch requiring a new spacing dimension with the adapter of 24 x 24 mm.

31-943.0



Description	Type No.	
<p>Connector for low-level switching elements</p> <p>Insulation socket for connector 31-945</p>	<p>31-945</p> <p>31-928</p>	
<p>Connector for axial snap-action switching element 2,8 mm</p> <p>Insulation socket for connector 31-946</p>	<p>31-946</p> <p>31-929</p>	

Description	Type No.	
Lens remover	02-905	
Lamp remover	02-906	
LED remover	51-996	
Dressing tool used as aid to aligning buttons	01-906	
Mounting tool for tightening (or loosening) fixing nuts	01-907	

Description	Type No.	
<p>Metal fixing ring (especially for keylock switches)</p>	<p>31-991</p>	
<p>Adhesive label for illuminated pushbuttons with microfuse 18 mm dia. x 24 mm</p>	<p>31-999</p>	

1. Engraving

Typefaces

In addition to the most commonly used world languages (see DIN 1451) with close spacing, the following typefaces are available: Scandinavian, Slavian, Greek, Russian.

Coloured filling of engraving

Red, blue and black lenses have the engraving filled with white. Lenses of other colours have the engraving filled with black.

Symbols

A list of the symbols available can be supplied on request.

2. Hot stamping

For large batches it is worth while to have the lettering produced by hot stamping.

Typefaces

For letters and figures, typefaces with 2,5 mm, 3 mm and 4 mm are available.

Symbols

A list of the symbols available can be supplied on request.



Important!

Before engraving, check the position of the illuminated pushbutton or indicator.

Height of letters mm	Thickness of letters mm	Horizontal mounting			Vertical mounting			Number of lines	Number of letters per line	Number of letters per line	Number of lines	Number of letters per line	Number of letters per line
		Number of lines	Number of letters per line	Number of letters per line	Number of lines	Number of letters per line	Number of letters per line						
h	s		(caps)	(small)		(caps)	(small)		(caps)	(small)		(caps)	(small)
2,5	0,4	4	11	12	5	7-8	8	3	6	6	4	7-8	8
3	0,4	3	9-10	10-11	4	6-7	7	2	5	6	3	6-7	7
4	0,5	2	7	7-8	3	4-5	5	2	3	4	2	4-5	5
5	0,5	2	5-6	6	2	3-4	4	1	2	3	2	3-4	4
6	0,6	1	4-5	5	2	3	3-4	1	2	3	1	3	3-4
8	0,6	1	3-4	3-4	1	2-3	2-3	1	2	2	1	2-3	2-3

3. Film inserts

Instead of using engraving, the lenses can be fitted with transparent film inserts. For this purpose, though, it is advisable to use transparent lenses. When a smoked lens is used, the lettering does not become visible until the lamp lights.

To insert the film, the feet of the lens support have to be pushed together far enough to enable the lens to be lifted off easily.

Film dimensions

max. 12,7 x 18,7 mm

12,7 x 12,7 mm

12,8 mm

Film thickness 0,2 mm

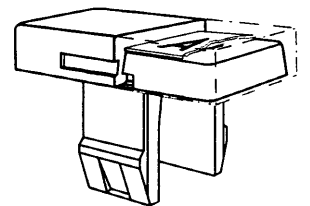

Компания «Океан Электроники» предлагает заключение долгосрочных отношений при поставках импортных электронных компонентов на взаимовыгодных условиях!

Наши преимущества:

- Поставка оригинальных импортных электронных компонентов напрямую с производств Америки, Европы и Азии, а так же с крупнейших складов мира;
- Широкая линейка поставок активных и пассивных импортных электронных компонентов (более 30 млн. наименований);
- Поставка сложных, дефицитных, либо снятых с производства позиций;
- Оперативные сроки поставки под заказ (от 5 рабочих дней);
- Экспресс доставка в любую точку России;
- Помощь Конструкторского Отдела и консультации квалифицированных инженеров;
- Техническая поддержка проекта, помощь в подборе аналогов, поставка прототипов;
- Поставка электронных компонентов под контролем ВП;
- Система менеджмента качества сертифицирована по Международному стандарту ISO 9001;
- При необходимости вся продукция военного и аэрокосмического назначения проходит испытания и сертификацию в лаборатории (по согласованию с заказчиком);
- Поставка специализированных компонентов военного и аэрокосмического уровня качества (Xilinx, Altera, Analog Devices, Intersil, Interpoint, Microsemi, Actel, Aeroflex, Peregrine, VPT, Syfer, Eurofarad, Texas Instruments, MS Kennedy, Miteq, Cobham, E2V, MA-COM, Hittite, Mini-Circuits, General Dynamics и др.);

Компания «Океан Электроники» является официальным дистрибьютором и эксклюзивным представителем в России одного из крупнейших производителей разъемов военного и аэрокосмического назначения «JONHON», а так же официальным дистрибьютором и эксклюзивным представителем в России производителя высокотехнологичных и надежных решений для передачи СВЧ сигналов «FORSTAR».



JONHON

«JONHON» (основан в 1970 г.)

Разъемы специального, военного и аэрокосмического назначения:

(Применяются в военной, авиационной, аэрокосмической, морской, железнодорожной, горно- и нефтедобывающей отраслях промышленности)

«FORSTAR» (основан в 1998 г.)

ВЧ соединители, коаксиальные кабели,
кабельные сборки и микроволновые компоненты:

(Применяются в телекоммуникациях гражданского и специального назначения, в средствах связи, РЛС, а так же военной, авиационной и аэрокосмической отраслях промышленности).



Телефон: 8 (812) 309-75-97 (многоканальный)

Факс: 8 (812) 320-03-32

Электронная почта: ocean@oceanchips.ru

Web: <http://oceanchips.ru/>

Адрес: 198099, г. Санкт-Петербург, ул. Калинина, д. 2, корп. 4, лит. А