

PISTONCAP® PRECISION TRIMMER CAPACITORS



Sprague-Goodman Electronics, Inc.

1700 SHAMES DRIVE, WESTBURY, NY 11590

TEL: 516-334-8700 • FAX: 516-334-8771

PRECISION ADJUST MECHANISMS

All Sprague-Goodman Pistoncap Trimmer Capacitors described in U. S. Patent No. 3,840,786 utilize a simplified and highly reliable adjust mechanism. There are two slots 180° apart, more than half way through the bushing threads. Following slotting, the bushing is compressed, causing the slotted end to behave as a spring. The threaded segments of the bushing are biased axially, pressing the bushing threads firmly into flank-to-flank engagement with the screw threads. This eliminates all backlash and provides the required smooth and uniform adjust torque. Note that no extra threaded washers, springs, etc. are required. Fewer parts mean greater reliability.

JFD PISTONCAP models, now manufactured by Sprague-Goodman, include the differential and split-stator types shown on page 11 of this bulletin. High Voltage and High RF Voltage quartz dielectric models are on page 15.



FORM FACTOR R, PANEL MOUNTING
SEALED CONSTRUCTION

COLLARED BUSHING STYLES (Form Factors N and V). Certain applications require that the head of the adjusting screw remain wholly within the bushing over the entire range of adjustment. To meet this need, collared bushing types, both sealed and unsealed, have been added to the broad line of printed circuit mounting styles. All panel mounting styles, other than the 'W' series, are also designed for blind hole tuning.



FORM FACTOR C, OPEN END



FORM FACTOR N, COLLARED BUSHING
OPEN END



FORM FACTOR P, OPEN END



FORM FACTOR V, COLLARED BUSHING
SEALED CONSTRUCTION

SEALED TYPES. Sealed versions are available in both panel mounting and printed circuit mounting. The electrode end is sealed either by closing the end of the glass tube or by soldering on a turret cap. The adjust end is sealed by means of a multi-lobed seal. This seal provides twice as many lobes as an "O" ring and good sealing is provided with one-quarter of the gasket compression required for an "O" ring.

W STYLES. In some panel-mounting applications, a protruding adjust screw is required. In W series capacitors, the adjust screw protrudes from the mounting bushing for all positions of adjustment.



FORM FACTOR L, PRINTED CIRCUIT SEALED



FORM FACTOR W

THREE DIELECTRICS. Three dielectrics are available. The standard glass has a dielectric constant of about 6.7 and a dissipation factor of about 0.0012. High-range glass achieves the unusual combination of higher dielectric constant but lower dissipation factor of about 8.5 and about 0.008, respectively. Quartz dielectric has the much lower dielectric constant of about 3.7 but has extremely low loss, for a dissipation factor of about 0.0001.

Generally, the standard glass, which is least expensive, will suit most applications. For some applications where higher capacitance and/or greater Q is required for a given physical structure, high-range glass should be specified. For applications involving moderate r-f currents, fused quartz is used.

High-range glass trimmers will generally cost about 25% more than standard glass and quartz trimmers are about three times the price of standard glass trimmers. Expanded range types generally cost about 2.5 times the non-expanded range equivalents.

EXPANDED RANGE models are available in both panel mounting and printed circuit mounting styles,

sealed and unsealed. The electrode band is embedded within the wall of the glass tube, providing a thinner dielectric gap and, at the same time, keeping the overall wall thick enough for mechanical strength. This generally yields about three times the capacitance range for a given size compared with the standard Pistoncap Capacitors. This is accomplished by a laminating technique. An electrode band is metallized on the O.D. of a thin (0.005") glass tube and a slightly larger and heavier walled tube is then telescoped over it. The two tubes are then fused, providing the embedded structure. Additional metallization is then added at both ends to provide electrical and mechanical termination.



FORM FACTOR R, EXPANDED RANGE

MILITARY APPROVALS

Pistoncap Precision Trimmer Capacitors are approved to Military Specification MIL-C-14409D, Styles PC35, PC37, PC38, PC39, PC40, PC41, PC42, PC43, PC48, PC50, PC51, and PC 52 in all characteristics and values and are listed on the Qualified Products List (QPL) for this specification. In Canada, these capacitors have been approved by the Department of National Defense in accordance with the terms of the U.S.-Canada agreement for qualification

of products of non-resident manufacturers. In the United Kingdom, these capacitors have been approved by the Ministry of Defense (DCVD) in accordance with the provisions of STANAG 4093, while in West Germany they have been approved by the Bundesamt für Wehrtechnik und Beschaffung (BWB) for G-QPL in accordance with STANAG 4093.

PART NUMBERING SYSTEM



PRINTED CIRCUIT MOUNTING



Figure 1A



Figure 1B

| Capacitance Range in pF Min. Max. | D-C Voltage Rating (Volts) | Temp. Char. (See Table) | Minimum Quality Factor Q | OPEN END STYLE (Fig. 1A) | | | | COLLARED BUSHING STYLE (Fig. 1B) | | | |
|--------------------------------------|----------------------------|-------------------------|--------------------------|--------------------------|-----------------|---------------|-------------------------|----------------------------------|---------------|-------------------------|--|
| | | | | Model No. | Mil Designation | A Max. In. mm | B ± 0.031 (0.79) In. mm | Model No. | A Max. In. mm | B ± 0.031 (0.79) In. mm | |
| STANDARD GLASS DIELECTRIC | | | | | | | | | | | |
| 0.8 4.5 | 750 | J | 500 | GGC4R500 | *PC41J4R5 | 0.312 7.92 | 0.250 6.35 | GGN4R500 | 0.343 8.71 | 0.250 6.35 | |
| 0.8 8.5 | 750 | J | 500 | GGC8R500 | *PC41J8R5 | 0.562 14.27 | 0.438 11.13 | GGN8R500 | 0.593 15.06 | 0.438 11.13 | |
| 0.8 12.0 | 750 | H | 500 | GGC12000 | *PC41H120 | 0.766 19.46 | 0.625 15.88 | GGN12000 | 0.797 20.24 | 0.625 15.88 | |
| 0.8 18.0 | 750 | H | 500 | GGC18000 | *PC41H180 | 1.000 25.40 | 0.875 22.23 | GGN18000 | 1.031 26.19 | 0.875 22.23 | |
| 0.8 30.0 | 750 | H | 350 | GGC30000 | *PC41H300 | 1.609 40.87 | 1.375 34.93 | GGN30000 | 1.640 41.66 | 1.375 34.93 | |
| HI-RANGE GLASS DIELECTRIC | | | | | | | | | | | |
| 0.8 5.5 | 750 | J | 1000 | GHC5R500 | PC51J5R5 | 0.312 7.92 | 0.250 6.35 | GHN5R500 | 0.343 8.71 | 0.250 6.35 | |
| 0.8 11.0 | 750 | J | 900 | GHC11000 | PC51J110 | 0.562 14.27 | 0.438 11.13 | GHN11000 | 0.593 15.06 | 0.438 11.13 | |
| 0.8 16.0 | 750 | H | 800 | GHC16000 | PC51H160 | 0.766 19.46 | 0.625 15.88 | GHN16000 | 0.797 20.24 | 0.625 15.88 | |
| 0.8 23.0 | 750 | H | 700 | GHC23000 | PC51H230 | 1.000 25.40 | 0.875 22.23 | GHN23000 | 1.031 26.19 | 0.875 22.23 | |
| 0.8 38.0 | 750 | H | 500 | GHC38000 | PC51H380 | 1.609 40.87 | 1.375 34.93 | GHN38000 | 1.640 41.66 | 1.375 34.93 | |
| QUARTZ DIELECTRIC | | | | | | | | | | | |
| 0.6 1.8 | 750 | Q | 1500 | GQC1R800 | PC41Q1R8 | 0.312 7.92 | 0.250 6.35 | | | | |
| 0.6 5.5 | 750 | Q | 1500 | GQC5R500 | PC41Q5R5 | 0.562 14.27 | 0.438 11.13 | | | | |
| 0.6 9.5 | 750 | Q | 1500 | GQC9R500 | PC41Q9R5 | 1.000 25.40 | 0.875 22.23 | | | | |
| 0.8 16.0 | 750 | Q | 1500 | GQC16000 | PC41Q160 | 1.609 40.87 | 1.375 34.93 | | | | |

*These capacitors were listed in MIL-C-14409B but do not appear in MIL-C-14409D.

MODIFICATIONS

To specify the modifications shown below, replace the last two digits of the catalog number with the modification no. See page 3.



No. 06
CYLINDER END CLOSED



No. 16
BASE LUG, SINGLE LEAD



No. 17
BASE LUG, DOUBLE LEAD

EXPANDED RANGE PRINTED CIRCUIT MOUNTING

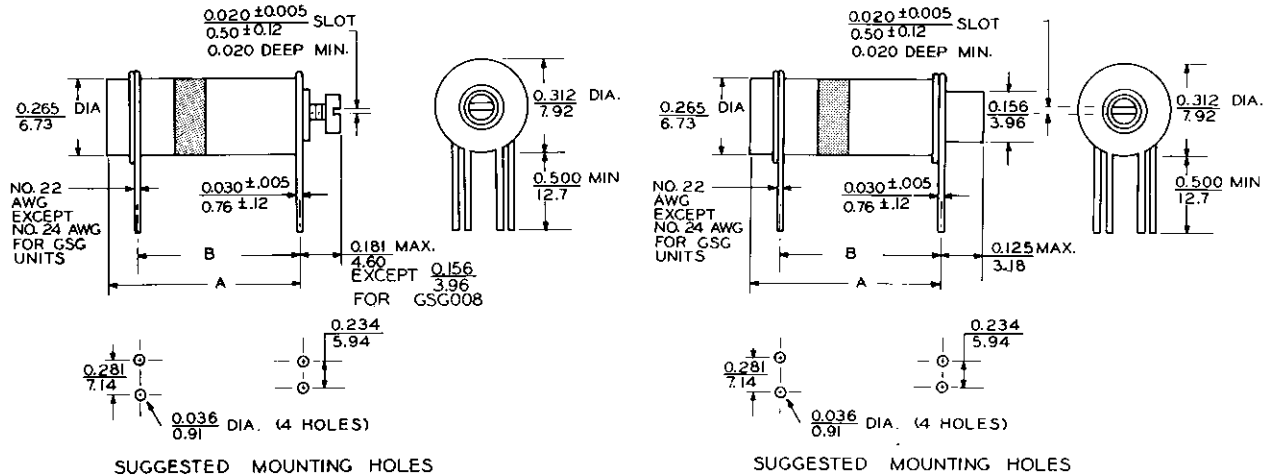

Figure 1C

Figure 1D

| Capacitance Range in pF Min. Max. | D-C Voltage Rating (Volts) | Temp. Char. (See Table) | Minimum Quality Factor Q | OPEN END STYLE (Fig. 1C) | | | | COLLARED BUSHING STYLE (Fig. 1D) | | | |
|--------------------------------------|----------------------------|-------------------------|--------------------------|--------------------------|---------------|-------------------------|-----------|----------------------------------|-------------------------|---|---|
| | | | | Model No. | A Max. In. mm | B ± 0.031 (0.79) In. mm | Model No. | A Max. In. mm | B ± 0.031 (0.79) In. mm | | |
| STANDARD GLASS DIELECTRIC | | | | | | | | | | | |
| 1.2 10.0 | 500 | Y | 500 | GSG008 | 0.277 7.04 | 0.250 6.35 | — | — | — | — | — |
| 1.0 14.0 | 750 | G | 500 | GEC14000 | 0.391 9.93 | 0.328 8.33 | GEN14000 | 0.422 10.72 | 0.328 8.33 | — | — |
| 1.0 28.0 | 750 | G | 350 | GEC28000 | 0.625 15.88 | 0.500 12.70 | GEN28000 | 0.656 16.66 | 0.500 12.70 | — | — |
| 1.0 42.0 | 750 | G | 250 | GEC42000 | 0.843 21.41 | 0.734 18.64 | GEN42000 | 0.875 22.23 | 0.734 18.64 | — | — |
| 1.0 60.0 | 750 | G | 250 | GEC60000 | 1.093 27.76 | 0.906 23.01 | GEN60000 | 1.125 28.58 | 0.906 23.01 | — | — |
| 1.0 90.0 | 750 | G | 250 | GEC90000 | 1.688 42.88 | 1.516 38.51 | GEN90000 | 1.719 43.66 | 1.516 38.51 | — | — |
| HI-RANGE GLASS DIELECTRIC | | | | | | | | | | | |
| 1.2 16.0 | 500 | Y | 750 | GSG009 | 0.323 8.20 | 0.250 6.35 | — | — | — | — | — |
| 1.0 16.0 | 750 | G | 750 | GFC16000 | 0.391 9.93 | 0.328 8.33 | GFN16000 | 0.422 10.72 | 0.328 8.33 | — | — |
| 1.0 36.0 | 750 | G | 550 | GFC36000 | 0.625 15.88 | 0.500 12.70 | GFN36000 | 0.656 16.66 | 0.500 12.70 | — | — |
| 1.0 52.0 | 750 | G | 350 | GFC52000 | 0.843 21.41 | 0.734 18.64 | GFN52000 | 0.875 22.23 | 0.734 18.64 | — | — |
| 1.0 75.0 | 750 | G | 250 | GFC75000 | 1.093 27.76 | 0.906 23.01 | GFN75000 | 1.125 28.58 | 0.906 23.01 | — | — |
| 1.0 120.0 | 750 | G | 250 | GFC12100 | 1.688 42.88 | 1.516 38.51 | GFN12100 | 1.719 43.66 | 1.516 38.51 | — | — |

NOTE: Capacitance increases up to 0.5 pF on vertical modifications due to position of leads alongside capacitor body.



SEALED PRINTED CIRCUIT MOUNTING



Figure 2A



Figure 2B

| Capacitance Range in pF Min. Max. | D-C Voltage Rating (Volts) | Temp. Char. (See Table) | Minimum Quality Factor Q | STANDARD SEALED STYLE (Fig. 2A) | | | | COLLARED BUSHING SEALED STYLE (Fig. 2B) | | | |
|--------------------------------------|----------------------------|-------------------------|--------------------------|---------------------------------|-----------------|---------------|-----------------------|---|---------------|-----------------------|--|
| | | | | Model No. | Mil Designation | A Max. In. mm | B±0.031 (0.79) In. mm | Model No. | A Max. In. mm | B±0.031 (0.79) In. mm | |
| STANDARD GLASS DIELECTRIC | | | | | | | | | | | |
| 0.8 4.5 | 750 | J | 500 | GGL4R500 | *PC42J4R5 | 0.656 16.66 | 0.500 12.70 | GGV4R500 | 0.422 10.72 | 0.250 6.35 | |
| 0.8 8.5 | 1250 | J | 500 | GGL8R500 | *PC42J8R5 | 0.906 23.01 | 0.703 17.86 | GGV8R500 | 0.641 16.28 | 0.438 11.13 | |
| 0.8 12.0 | 1250 | H | 500 | GGL12000 | *PC42H120 | 1.109 28.17 | 0.844 21.44 | GGV12000 | 0.859 21.82 | 0.625 15.88 | |
| 0.8 18.0 | 1250 | H | 500 | GGL18000 | *PC42H180 | 1.359 34.52 | 1.016 25.81 | GGV18000 | 1.109 28.17 | 0.875 22.23 | |
| 0.8 30.0 | 1250 | H | 350 | GGL30000 | *PC42H300 | 1.953 49.61 | 1.469 37.31 | GGV30000 | 1.703 43.26 | 1.375 34.93 | |
| HI-RANGE GLASS DIELECTRIC | | | | | | | | | | | |
| 0.8 5.5 | 750 | J | 1000 | GHL5R500 | PC52J5R5 | 0.656 16.66 | 0.500 12.70 | GHV5R500 | 0.422 10.72 | 0.250 6.35 | |
| 0.8 11.0 | 1250 | J | 900 | GHL11000 | PC52J110 | 0.906 23.01 | 0.703 17.86 | GHV11000 | 0.641 16.28 | 0.438 11.13 | |
| 0.8 16.0 | 1250 | H | 800 | GHL16000 | PC52H160 | 1.109 28.17 | 0.844 21.44 | GHV16000 | 0.859 21.82 | 0.625 15.88 | |
| 0.8 23.0 | 1250 | H | 700 | GHL23000 | PC52H230 | 1.359 34.52 | 1.016 25.81 | GHV23000 | 1.109 28.17 | 0.875 22.23 | |
| 0.8 38.0 | 1250 | H | 500 | GHL38000 | PC52H380 | 1.953 49.61 | 1.469 37.31 | GHV38000 | 1.703 43.26 | 1.375 34.93 | |
| QUARTZ DIELECTRIC | | | | | | | | | | | |
| 0.6 1.8 | 750 | Q | 1500 | GQL1R800 | PC42Q1R8 | 0.656 16.66 | 0.500 12.70 | | | | |
| 0.6 5.5 | 1250 | Q | 1500 | GQL5R500 | PC42Q5R5 | 0.922 23.42 | 0.703 17.86 | | | | |
| 0.6 9.5 | 1250 | Q | 1500 | GQL9R500 | PC42Q9R5 | 1.359 34.52 | 1.016 25.81 | | | | |
| 0.8 16.0 | 1250 | Q | 1500 | GQL16000 | PC42Q160 | 1.953 49.61 | 1.469 37.31 | | | | |

*These capacitors were listed in Military Specification MIL-C-14409B but do not appear in MIL-C-14409D.

MODIFICATIONS



No. 16
BASE LUG, SINGLE LEAD



No. 17
BASE LUG, DOUBLE LEAD

EXPANDED RANGE SEALED PRINTED CIRCUIT MOUNTING



Figure 2C

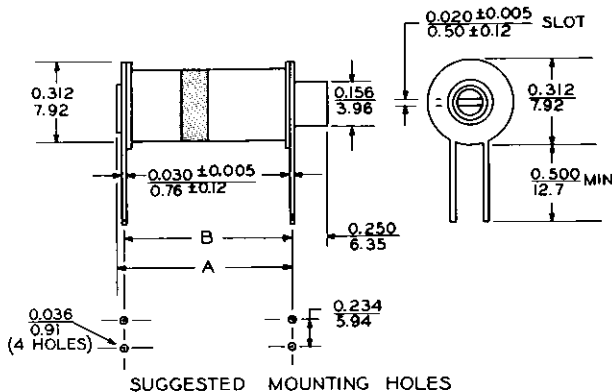

Figure 2D

| Capacitance Range in pF Min. Max. | D-C Voltage Rating (Volts) | Temp. Char. (See Table) | Minimum Quality Factor Q | SEALED END STYLE (Fig. 2C) | | | | COLLARED BUSHING STYLE (Fig. 2D) | | | |
|--------------------------------------|----------------------------|-------------------------|--------------------------|----------------------------|-----------------|---------------|-------------------------|----------------------------------|---------------|-------------------------|--|
| | | | | Model No. | Mil Designation | A Max. In. mm | B ± 0.031 (0.79) In. mm | Model No. | A Max. In. mm | B ± 0.031 (0.79) In. mm | |
| STANDARD GLASS | | | | | | | | | | | |
| 1.0 14.0 | 1000 | G | 500 | GEL14000 | *PC43G140 | 0.780 19.81 | 0.700 17.78 | GEV14000 | 0.484 12.29 | 0.422 10.72 | |
| 1.0 28.0 | 1000 | G | 350 | GEL28000 | *PC43G280 | 1.020 25.91 | 0.940 23.88 | GEV28000 | 0.734 18.64 | 0.672 17.07 | |
| 1.0 42.0 | 1000 | G | 250 | GEL42000 | *PC43G420 | 1.235 31.37 | 1.155 29.34 | GEV42000 | 0.938 23.83 | 0.875 22.23 | |
| 1.0 60.0 | 1000 | G | 250 | GEL60000 | *PC43G600 | 1.480 37.59 | 1.400 35.56 | GEV60000 | 1.188 30.18 | 1.125 28.58 | |
| 1.0 90.0 | 1000 | G | 250 | GEL90000 | *PC43G900 | 2.080 52.83 | 2.000 50.80 | GEV90000 | 1.781 45.24 | 1.734 44.04 | |
| HI-RANGE GLASS | | | | | | | | | | | |
| 1.0 16.0 | 1000 | G | 750 | GFL16000 | PC43G160 | 0.780 19.81 | 0.700 17.78 | GFV16000 | 0.484 12.29 | 0.422 10.72 | |
| 1.0 36.0 | 1000 | G | 550 | GFL36000 | PC43G360 | 1.020 25.91 | 0.940 23.88 | GFV36000 | 0.734 18.64 | 0.672 17.07 | |
| 1.0 52.0 | 1000 | G | 350 | GFL52000 | PC43G520 | 1.235 31.37 | 1.155 29.34 | GFV52000 | 0.938 23.83 | 0.875 22.23 | |
| 1.0 75.0 | 1000 | G | 250 | GFL75000 | PC43G750 | 1.480 37.59 | 1.400 35.56 | GFV75000 | 1.188 30.18 | 1.125 28.58 | |
| 1.0 120.0 | 1000 | G | 250 | GFL12100 | PC43G121 | 2.080 52.83 | 2.000 50.80 | GFV12100 | 1.781 45.24 | 1.734 44.04 | |

*These capacitors were listed in Military Specification MIL-C-14409B but do not appear in MIL-C-14409D.

NOTE: Capacitance increases up to 0.5 pF on vertical modifications due to position of leads alongside capacitor body.

SIDE VIEW APPLIES FOR ALL TURRET PIN MODIFICATIONS



No. 21
4-WIRE VERTICAL

No. 22
2-WIRE AND LUG VERTICAL

TURRET PIN VERTICAL
No. 25 AND 2-WIRE
No. 26 AND LUG
No. 27 AND 1 WIRE

PANEL MOUNTING



Figure 3A

SEALED PANEL MOUNTING

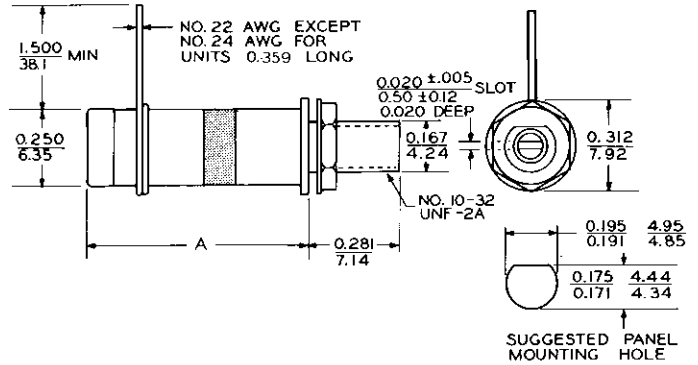

Figure 3B

| Capacitance Range in pF Min. Max. | D-C Voltage Rating (Volts) | Min. Quality Factor Q | Temp. Char. (See Table) | Model No. Figure 3A | Mil Designation | A | |
|--------------------------------------|----------------------------|-----------------------|-------------------------|---------------------|-----------------|--|--|
| | | | | | | +0.047, -0.031 (+1.19, -0.79) In. mm | |
| STANDARD GLASS | | | | | | | |
| 0.8 4.5 | 750 | 500 | J | GGP4R500 | *PC40J4R5 | 0.297 7.54 | |
| 0.8 8.5 | 750 | 500 | J | GGP8R500 | *PC40J8R5 | 0.547 13.89 | |
| 0.8 12.0 | 750 | 500 | H | GGP12000 | *PC40H120 | 0.750 19.05 | |
| 0.8 18.0 | 750 | 500 | H | GGP18000 | *PC40H180 | 0.984 24.99 | |
| 0.8 30.0 | 750 | 350 | H | GGP30000 | *PC40H300 | 1.594 40.49 | |
| HI-RANGE GLASS | | | | | | | |
| 0.8 5.5 | 750 | 1000 | J | GHP5R500 | PC50J5R5 | 0.297 7.54 | |
| 0.8 11.0 | 750 | 900 | J | GHP11000 | PC50J110 | 0.547 13.89 | |
| 0.8 16.0 | 750 | 800 | H | GHP16000 | PC50H160 | 0.750 19.05 | |
| 0.8 23.0 | 750 | 700 | H | GHP23000 | PC50H230 | 0.984 24.99 | |
| 0.8 38.0 | 750 | 500 | H | GHP38000 | PC50H380 | 1.594 40.49 | |
| QUARTZ | | | | | | | |
| 0.6 1.8 | 750 | 1500 | Q | GQP1R800 | PC40Q1R8 | 0.297 7.54 | |
| 0.6 5.5 | 750 | 1500 | Q | GQP5R500 | PC40Q5R5 | 0.547 13.89 | |
| 0.6 9.5 | 750 | 1500 | Q | GQP9R500 | PC40Q9R5 | 0.984 24.99 | |
| 0.8 16.0 | 750 | 1500 | Q | GQP16000 | PC40Q160 | 1.594 40.49 | |

| Capacitance Range in pF Min. Max. | D-C Voltage Rating (Volts) | Min. Quality Factor Q | Temp. Char. (See Table) | Model No. Figure 3B | Mil Designation | Length A ± 0.031 (0.79) In. mm | |
|--------------------------------------|----------------------------|-----------------------|-------------------------|---------------------|-----------------|--------------------------------------|--|
| | | | | | | | |
| STANDARD GLASS | | | | | | | |
| 0.8 4.5 | 750 | 500 | J | GGR4R500 | *PC38J4R5 | 0.359 9.12 | |
| 0.8 8.5 | 1250 | 500 | J | GGR8R500 | *PC38J8R5 | 0.594 15.09 | |
| 0.8 12.0 | 1250 | 500 | H | GGR12000 | *PC38H120 | 0.812 20.62 | |
| 0.8 18.0 | 1250 | 500 | H | GGR18000 | *PC38H180 | 1.062 26.97 | |
| 0.8 30.0 | 1250 | 350 | H | GGR30000 | *PC38H300 | 1.656 42.06 | |
| HI-RANGE GLASS | | | | | | | |
| 0.8 5.5 | 750 | 1000 | J | GHR5R500 | PC48J5R5 | 0.359 9.12 | |
| 0.8 11.0 | 1250 | 900 | J | GHR11000 | PC48J110 | 0.594 15.09 | |
| 0.8 16.0 | 1250 | 800 | H | GHR16000 | PC48H160 | 0.812 20.62 | |
| 0.8 23.0 | 1250 | 700 | H | GHR23000 | PC48H230 | 1.062 26.97 | |
| 0.8 38.0 | 1250 | 500 | H | GHR38000 | PC48H380 | 1.656 42.06 | |
| QUARTZ | | | | | | | |
| 0.6 1.8 | 750 | 1500 | Q | GQR1R800 | PC38Q1R8 | 0.359 9.12 | |
| 0.6 5.5 | 1250 | 1500 | Q | GQR5R500 | PC38Q5R5 | 0.625 15.88 | |
| 0.6 9.5 | 1250 | 1500 | Q | GQR9R500 | PC38Q9R5 | 1.062 26.97 | |
| 0.8 16.0 | 1250 | 1500 | Q | GQR16000 | PC38Q160 | 1.656 42.06 | |

*These capacitors were listed in Military Specification MIL-C-14409B but do not appear in MIL-C-14409D.

MODIFICATIONS



EXPANDED RANGE PANEL MOUNTING



Figure 3C

EXPANDED RANGE SEALED PANEL MOUNTING



Figure 3D

| Capacitance Range in pF Min. Max. | D-C Voltage Rating (Volts) | Minimum Quality Factor Q | Temp. Char. (See Table) | Model No. Figure 3C | A | |
|--------------------------------------|----------------------------|--------------------------|-------------------------|---------------------|-----------------------|-------|
| | | | | | ± 0.031 (0.79) In. | mm |
| STANDARD GLASS DIELECTRIC | | | | | | |
| 1.2 10.0 | 500 | 500 | Y | GSG006 | 0.266 | 6.76 |
| 1.0 14.0 | 750 | 500 | G | GEP14000 | 0.375 | 9.53 |
| 1.0 28.0 | 750 | 350 | G | GEP28000 | 0.609 | 15.47 |
| 1.0 42.0 | 750 | 250 | G | GEP42000 | 0.828 | 21.03 |
| 1.0 60.0 | 750 | 250 | G | GEP60000 | 1.078 | 27.38 |
| 1.0 90.0 | 750 | 250 | G | GEP90000 | 1.672 | 42.47 |
| HI-RANGE GLASS DIELECTRIC | | | | | | |
| 1.2 16.0 | 500 | 750 | Y | GSG007 | 0.312 | 7.92 |
| 1.0 16.0 | 750 | 750 | G | GFP16000 | 0.375 | 9.53 |
| 1.0 36.0 | 750 | 550 | G | GFP36000 | 0.609 | 15.47 |
| 1.0 52.0 | 750 | 350 | G | GFP52000 | 0.828 | 21.03 |
| 1.0 75.0 | 750 | 250 | G | GFP75000 | 1.078 | 27.38 |
| 1.0 120.0 | 750 | 250 | G | GFP12100 | 1.672 | 42.47 |

| Capacitance Range in pF Min. Max. | D-C Voltage Rating (Volts) | Min. Quality Factor Q | Temp. Char. (See Table) | Model No. Figure 3D | Mil Designation | Length A | |
|--------------------------------------|----------------------------|-----------------------|-------------------------|---------------------|-----------------|-----------------------|-------|
| | | | | | | ± 0.031 (0.79) In. | mm |
| STANDARD GLASS | | | | | | | |
| 1.0 14 | 1000 | 500 | G | GER14000 | *PC39G140 | 0.469 | 11.91 |
| 1.0 28 | 1000 | 350 | G | GER28000 | *PC39G280 | 0.703 | 17.86 |
| 1.0 42 | 1000 | 250 | G | GER42000 | *PC39G420 | 0.922 | 23.42 |
| 1.0 60 | 1000 | 250 | G | GER60000 | *PC39G600 | 1.172 | 29.77 |
| 1.0 90 | 1000 | 250 | G | GER90000 | *PC39G900 | 1.766 | 44.86 |
| HI-RANGE GLASS | | | | | | | |
| 1.0 16 | 1000 | 750 | G | GFR16000 | PC39G160 | 0.469 | 11.91 |
| 1.0 36 | 1000 | 550 | G | GFR36000 | PC39G360 | 0.703 | 17.86 |
| 1.0 52 | 1000 | 350 | G | GFR52000 | PC39G520 | 0.922 | 23.42 |
| 1.0 75 | 1000 | 250 | G | GFR75000 | PC39G750 | 1.172 | 29.77 |
| 1.0 120 | 1000 | 250 | G | GFR12100 | PC39G121 | 1.766 | 44.86 |

*These capacitors were listed in Military Specification MIL-C-14409B but do not appear in MIL-C-14409D.



No. 13
WELDABLE LEAD



No. 14
TURRET CAP



No. 15
DOUBLE LEADS



No. 30
INSULATED NYLON BUSHING

EXTENDED-SCREW, 1/4" DIA. MOUNTING BUSHING

SPECIFICATIONS

Operating Temperature Range:

-55°C to +125°C (Glass)
-55°C to +150°C (Quartz)

Voltage Rating: 750 Volts D-C

Wire Size:

No. 22 AWG
Except GGW3R000
No. 24 AWG



TYPES GGW, GHW, GSG904 THRU 906

TYPES GQW, GSG900 THRU 903, AND GSG907 THRU 910

| Cap. Range in pF | | Min. Q at 20 MHz | Temp. Coeff. in ppm/°C | Model No. | Length | | Screw Extension | |
|---|------|------------------|------------------------|-----------|----------|-----------|-----------------|-------|
| Min. | Max. | | | | A ± .031 | mm ± 0.79 | B Max. | mm |
| STANDARD GLASS | | | | | | | | |
| 0.5 | 3.0 | 500 | ± 50 | GGW3R000 | 0.484 | 12.29 | 0.625 | 15.88 |
| 0.8 | 8.5 | 500 | ± 75 | GGW8R500 | 0.578 | 14.68 | 0.625 | 15.88 |
| 0.7 | 9.0 | 500 | ± 75 | GGW9R000 | 0.656 | 16.66 | 0.656 | 16.66 |
| 0.8 | 12.0 | 500 | ± 100 | GGW12000 | 0.765 | 19.43 | 0.750 | 19.05 |
| 0.8 | 18.0 | 500 | ± 100 | GGW18000 | 1.000 | 25.40 | 0.843 | 21.41 |
| 0.8 | 30.0 | 500 | ± 100 | GGW30000 | 1.594 | 40.49 | 1.141 | 28.98 |
| HI-RANGE GLASS | | | | | | | | |
| 0.5 | 4.5 | 1000 | ± 100 | GHW4R500 | 0.484 | 12.29 | 0.625 | 15.88 |
| 0.8 | 11.0 | 900 | ± 100 | GHW11000 | 0.578 | 14.68 | 0.625 | 15.88 |
| 0.8 | 13.0 | 900 | ± 100 | GHW13000 | 0.609 | 15.47 | 0.625 | 15.88 |
| 0.8 | 17.0 | 800 | ± 100 | GHW17000 | 0.765 | 19.43 | 0.750 | 19.05 |
| 1.0 | 24.0 | 700 | ± 100 | GHW24000 | 1.000 | 25.40 | 0.812 | 20.62 |
| 1.0 | 40.0 | 500 | ± 100 | GHW40000 | 1.594 | 40.49 | 1.125 | 28.58 |
| STANDARD GLASS — SPECIAL TEMP. COEFF.* | | | | | | | | |
| 0.7 | 9.0 | 500 | +400 ± 100 | GSG904 | 0.656 | 16.66 | 0.797 | 20.24 |
| 0.8 | 18.0 | 500 | +400 ± 100 | GSG905 | 1.000 | 25.40 | 0.938 | 23.83 |
| 0.8 | 30.0 | 500 | +400 ± 100 | GSG906 | 1.594 | 40.49 | 1.250 | 31.75 |
| QUARTZ (C = 0.250 DIA. TUBE) | | | | | | | | |
| 0.6 | 5.5 | 1500 | +50, -0 | GQW5R500 | 0.563 | 14.30 | 0.765 | 19.43 |
| 0.6 | 9.5 | 1500 | +50, -0 | GQW9R500 | 1.000 | 25.40 | 0.891 | 22.63 |
| 0.8 | 16.0 | 1500 | +50, -0 | GQW16000 | 1.594 | 40.49 | 1.250 | 31.75 |
| QUARTZ (C = 0.250 DIA. TUBE)* | | | | | | | | |
| 0.7 | 4.5 | 1500 | +50, -0 | GSG907 | 0.438 | 11.13 | 0.546 | 13.87 |
| 0.6 | 6.0 | 1500 | +50, -0 | GSG908 | 0.625 | 15.88 | 0.906 | 23.01 |
| 0.8 | 10.0 | 1500 | +50, -0 | GSG909 | 1.000 | 25.40 | 0.891 | 22.63 |
| 9.0 | 21.0 | 1500 | +50, -0 | GSG910 | 1.594 | 40.49 | 1.000 | 25.40 |
| STANDARD GLASS (C = 0.250 DIA. TUBE)* | | | | | | | | |
| 0.7 | 9.0 | 500 | +0, -150 | GSG900 | 0.656 | 16.66 | 0.765 | 19.43 |
| 0.6 | 14.0 | 500 | +0, -150 | GSG901 | 1.000 | 25.40 | 1.000 | 25.40 |
| 0.8 | 18.0 | 500 | +0, -150 | GSG902 | 1.000 | 25.40 | 0.953 | 24.21 |
| 0.8 | 30.0 | 500 | +0, -150 | GSG903 | 1.594 | 40.49 | 1.250 | 31.75 |

*The "GSG" model prefix signifies a special design. Part numbers for these devices are assigned sequentially and are not in accordance with the standard part numbering system.

MINIATURE SPLIT STATOR CAPACITORS

Piston adjustment varies capacitance simultaneously from each plate to bushing and from plate to plate for use in push-pull circuits and similar networks.

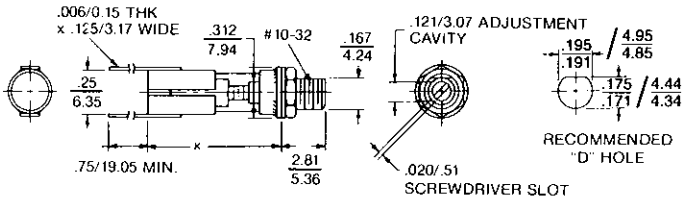

C₁ = Capacitance of Electrode Band 1 to Ground.
 C₂ = Capacitance of Electrode Band 2 to Ground.
 C₃ = Capacitance of Electrode Band 1 to Electrode Band 2.

Panel Mounting Model. For other configurations, contact factory.

| Model No. | Cap. Range (pF) | | | | K ± 0.031/0.79 | |
|------------|------------------|------|----------------|------|----------------|-------|
| | Plate to Bushing | | Plate to Plate | | in. | mm |
| | Min. | Max. | Min. | Max. | | |
| JFD-SP86GY | 0.8 | 4.2 | 0.8 | 2.0 | .547 | 13.89 |
| JFD-SP87GY | 0.8 | 9.0 | 1.5 | 4.5 | 1.000 | 25.40 |
| JFD-SP88GY | 1.0 | 14.0 | 2.0 | 7.0 | 1.609 | 40.87 |

MINIATURE DIFFERENTIAL CAPACITORS

Piston adjustment increases capacitance of one gang while capacitance of other gang decreases.

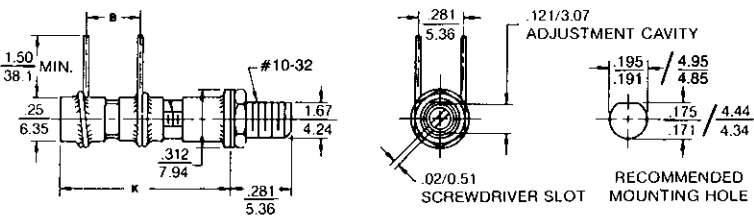

C₁ = Capacitance of Electrode Band 1 to Ground.
 C₂ = Capacitance of Electrode Band 2 to Ground.
 C₃ = Capacitance of Electrode Band 1 to Electrode Band 2.

Panel Mounting Model. For other configurations, contact factory.

| Model No. | Sect. | Cap. Range (pF) | | Typical (pF) Crossover | B ± .024/0.62 | | K ± .031/0.79 | | Wire Dia. | |
|------------|---------|-----------------|------|------------------------|---------------|-------|---------------|-------|-----------|-----|
| | | Min. | Max. | | in. | mm | in. | mm | in. | mm |
| JFD-DC411Y | Sect. 1 | 0.7 | 3.0 | 2.3 | .094 | 2.39 | .312 | 7.92 | .016 | .41 |
| | Sect. 2 | 2.0 | 3.0 | | | | | | | |
| JFD-DC413Y | Sect. 1 | 1.0 | 8.0 | 5.0 | .219 | 5.56 | .547 | 13.89 | .020 | .51 |
| | Sect. 2 | 3.0 | 8.0 | | | | | | | |
| JFD-DC414Y | Sect. 1 | 1.0 | 12.0 | 6.8 | .312 | 7.92 | .750 | 19.05 | .025 | .64 |
| | Sect. 2 | 3.5 | 12.0 | | | | | | | |
| JFD-DC416Y | Sect. 1 | 1.5 | 16.0 | 9.2 | .406 | 10.31 | .937 | 23.80 | .025 | .64 |
| | Sect. 2 | 4.0 | 11.0 | | | | | | | |
| JFD-DC419Y | Sect. 1 | 2.0 | 26.0 | 15.2 | .656 | 16.66 | 1.437 | 36.50 | .025 | .64 |
| | Sect. 2 | 6.0 | 28.0 | | | | | | | |

Sect. #1: Base to end electrode
 Sect. #2: Base to center electrode

NOTES:

- TCC = 0 ± 100 ppm/°C; -55°C to +125°C
- Q @ 20 MHz: 500 min.
- Adjust torque: 1-10 oz.-in.
- Working Voltage Rating: 500 VDC
- Drift = 0.2% or 0.04 pF
- IR = 10⁹ MΩ

Surface Mount Glass PISTONCAP®

Vertical and Horizontal Mount Types

Available in Standard and Extended Range Models

VERTICAL MOUNT TYPES

EXTERNAL ELECTRODE

| Capacitance Range in pF | | D-C Voltage Rating (Volts) | Temp. Char. (See Table) | Minimum Quality Factor Q | A max | | Unsealed Model No. (See Note 2) | Sealed Model No. |
|-------------------------|--------------|----------------------------|-------------------------|--------------------------|-------|------|---------------------------------|----------------------|
| min | max | | | | in | mm | | |
| 1.3 | 4.5 5.5 | 750 | J | 500 1000 | 0.383 | 9.73 | GGN4R531 GHN5R531 | GGV4R531 GHV5R531 |
| 1.3 | 8.5 11.0 | 750 | J | 500 900 | 0.633 | 16.1 | GGN8R531 GHN11031 | GGV8R531 GHV11031 |
| 1.3 | 12.0 16.0 | 750 | H | 500 800 | 0.837 | 21.3 | GGN12031 GHN16031 | GGV12031 GHV16031 |
| 1.3 | 18.0 23.0 | 750 | H | 500 700 | 1.071 | 27.2 | GGN18031 GHN23031 | GGV18031 GHV23031 |

EMBEDDED ELECTRODE

| Capacitance Range in pF | | D-C Voltage Rating (Volts) | Temp. Char. (See Table) | Minimum Quality Factor Q | A max | | Unsealed Model No. (See Note 2) | Sealed Model No. |
|-------------------------|--------------|----------------------------|-------------------------|--------------------------|-------|------|---------------------------------|----------------------|
| min | max | | | | in | mm | | |
| 1.5 | 14.5 16.5 | 1000 | G | 500 750 | 0.462 | 11.7 | GEN14031 GFN16031 | GEV14031 GFV16031 |
| 1.5 | 28.5 36.5 | 1000 | G | 350 550 | 0.696 | 17.7 | GEN28031 GFN36031 | GEV28031 GFV36031 |



VERTICAL MOUNT

Notes:

1) Unsealed models: 0.120
3.05

Sealed models: 0.245
6.22

2) For an optional sealing cap to cover adjustment access on unsealed models, contact factory.

HORIZONTAL MOUNT TYPES

EXTERNAL ELECTRODE

| Capacitance Range in pF | | D-C Voltage Rating (Volts) | Temp. Char. (See Table) | Minimum Quality Factor Q | A max | | Unsealed Model No. (See Note 2) | Sealed Model No. |
|-------------------------|--------------|----------------------------|-------------------------|--------------------------|-------|------|---------------------------------|----------------------|
| min | max | | | | in | mm | | |
| 0.8 | 8.5 11.0 | 750 | J | 500 900 | 0.673 | 17.1 | GGN8R533 GHN11033 | GGV8R533 GHV11033 |
| 0.8 | 12.0 16.0 | 750 | H | 500 800 | 0.877 | 22.3 | GGN12033 GHN16033 | GGV12033 GHV16033 |
| 0.8 | 18.0 23.0 | 750 | H | 500 700 | 1.111 | 28.2 | GGN18033 GHN23033 | GGV18033 GHV23033 |
| 0.8 | 30.0 38.0 | 750 | H | 350 500 | 1.720 | 43.7 | GGN30033 GHN38033 | GGV30033 GHV38033 |

EMBEDDED ELECTRODE

| Capacitance Range in pF | | D-C Voltage Rating (Volts) | Temp. Char. (See Table) | Minimum Quality Factor Q | A max | | Unsealed Model No. (See Note 2) | Sealed Model No. |
|-------------------------|---------------|----------------------------|-------------------------|--------------------------|-------|------|---------------------------------|----------------------|
| min | max | | | | in | mm | | |
| 1.0 | 28.0 36.0 | 1000 | G | 350 550 | 0.736 | 18.7 | GEN28033 GFN36033 | GEV28033 GFV36033 |
| 1.0 | 42.0 52.0 | 1000 | G | 250 350 | 0.955 | 24.3 | GEN42033 GFN52033 | GEV42033 GFV52033 |
| 1.0 | 60.0 75.0 | 1000 | G | 250 250 | 1.205 | 30.6 | GEN60033 GFN75033 | GEV60033 GFV75033 |
| 1.0 | 90.0 120.0 | 1000 | G | 250 250 | 1.799 | 45.7 | GEN90033 GFN12133 | GEV90033 GFV12133 |



HORIZONTAL MOUNT

Notes:

1) Unsealed models: 0.120
3.05

Sealed models: 0.245
6.22

2) For an optional sealing cap to cover adjustment access on unsealed models, contact factory.

DIRECT TRAVERSE GLASS TRIMMERS

FEATURES

- Shortest sealed PISTONCAP®
- Designed to meet MIL-C-14409.
- Annular band and embedded band models.
- High Q.
- High self-resonant frequency.
- Surface mount or through-hole mount.
- O-ring seal protects (to 276 kPa, 40 psi) against dust, flux, moisture, solder and solvents.
- Direct traverse (non-rotating) piston.

SPECIFICATIONS

Operating Temperature Range: -55°C to 125°C
 Voltage Rating: 250 VDC
 Dielectric Withstanding Voltage: 500 VDC
 Insulation Resistance: 10⁶ Megohms min
 Torque: 36 to 360 g-cm (0.50 to 5.0 oz-in)
 Tuning Resolution:
 0.7 pF per turn for Annular Band
 2.7 pF per turn for Embedded Band



| | Capacitance Range (pF) | | TCC (ppm/°C) | Q min (1 MHz) | A max (in/mm) | Surface Mount Model No. | Through-hole Model No. |
|-----------------------------|------------------------|-----|--------------|---------------|---------------|-------------------------|------------------------|
| | min | max | | | | | |
| Annular Band Models | 1.0 | 5.5 | 0 ± 50 | 1000 | 0.42/11 | GDT5R531 | GDT5R526 |
| | 1.0 | 8.5 | 0 ± 50 | 650 | 0.57/14 | GDT8R531 | GDT8R526 |
| Embedded Band Models | 1.5 | 10 | 0 ± 150 | 800 | 0.37/9.4 | GDT10031 | GDT10026 |
| | 1.5 | 20 | 0 ± 150 | 800 | 0.44/11 | GDT20031 | GDT20026 |
| | 1.5 | 30 | 0 ± 150 | 800 | 0.52/13 | GDT30031 | GDT30026 |
| | 1.5 | 40 | 0 ± 150 | 800 | 0.63/16 | GDT40031 | GDT40026 |



Note: For horizontal mounting configurations, contact factory.
 All dimensions are in / mm.
 Unless otherwise specified, the tolerance on all dimensions is ±0.005/0.1, except slot tolerance is ±0.002/0.05.

CUSTOM PISTONCAP® CAPACITOR DESIGNS

There are many possible design variations utilizing Pistoncap technology. The standard modifications given on pages 4 through 9 show the more popular design variations. In addition, dual electrode band models (differential) and split electrode band models (split stator) are shown below. Both styles are available in any of the standard or modified mechanical designs listed in the bulletin.

Pistoncaps are rated quite conservatively for both minimum and maximum capacitance. Therefore, units with a larger guaranteed range can be supplied on special order.

Shown at right is a variety of special leads, lugs, and combinations of leads and lugs available on Sprague-Goodman Pistoncap capacitors. These, in addition to other possibilities, afford the design engineer a wide selection of mounting and attachment for his packaging requirements.



NOTES ON MEASUREMENTS

1. Capacitance measured at 1 MHz \pm 100 kHz in a test fixture incorporating a guard provision.
2. Dielectric Strength: Twice Rated Voltage.
3. Dielectric strength measured at maximum rated capacitance.
4. Insulation Resistance: 10^6 Megohms at +25°C.
5. Insulation resistance at peak operating temperature: see table.
6. Insulation resistance measured at maximum rated capacitance with 500 \pm 50 volts applied for 1 minute.
7. Quality factor (Q) measured at 20 MHz \pm 200 kHz at maximum rated capacitance.
8. Temperature coefficient of capacitance measured at 1 MHz \pm 100 kHz at approximately 75% of maximum rated capacitance.
9. All measurements per MIL-C-14409D.
10. Driving torque: 1 to 10 ounce-inches.
11. Tolerance on dimensions: \pm 0.016 (\pm 0.41 mm) unless otherwise specified.

TEMPERATURE TABLE

| Temp. Char. | Operating Temperature Range | Temp. Coefficient (ppm/°C) | Max. Drift | IR at Peak Temp. (MΩ) |
|-------------|-----------------------------|----------------------------|-----------------------|-----------------------|
| G | - 55°C to + 125°C | \pm 150 | \pm 0.5% | 10^5 |
| H | - 55°C to + 125°C | \pm 100 | \pm 0.2% or 0.04pF | 10^5 |
| J | - 55°C to + 125°C | \pm 50 | \pm 0.15% or 0.02pF | 10^5 |
| Q | - 55°C to + 150°C | + 50, -0 | \pm 0.10% or 0.01pF | 10^6 |
| Y | - 55°C to + 125°C | + 75, \pm 75 | \pm 0.5% | 10^5 |



Sprague-Goodman Electronics, Inc.

1700 SHAMES DRIVE, WESTBURY, NY 11590

TEL: 516-334-8700 • FAX: 516-334-8771

Компания «Океан Электроники» предлагает заключение долгосрочных отношений при поставках импортных электронных компонентов на взаимовыгодных условиях!

Наши преимущества:

- Поставка оригинальных импортных электронных компонентов напрямую с производств Америки, Европы и Азии, а так же с крупнейших складов мира;
- Широкая линейка поставок активных и пассивных импортных электронных компонентов (более 30 млн. наименований);
- Поставка сложных, дефицитных, либо снятых с производства позиций;
- Оперативные сроки поставки под заказ (от 5 рабочих дней);
- Экспресс доставка в любую точку России;
- Помощь Конструкторского Отдела и консультации квалифицированных инженеров;
- Техническая поддержка проекта, помощь в подборе аналогов, поставка прототипов;
- Поставка электронных компонентов под контролем ВП;
- Система менеджмента качества сертифицирована по Международному стандарту ISO 9001;
- При необходимости вся продукция военного и аэрокосмического назначения проходит испытания и сертификацию в лаборатории (по согласованию с заказчиком);
- Поставка специализированных компонентов военного и аэрокосмического уровня качества (Xilinx, Altera, Analog Devices, Intersil, Interpoint, Microsemi, Actel, Aeroflex, Peregrine, VPT, Syfer, Eurofarad, Texas Instruments, MS Kennedy, Miteq, Cobham, E2V, MA-COM, Hittite, Mini-Circuits, General Dynamics и др.);

Компания «Океан Электроники» является официальным дистрибьютором и эксклюзивным представителем в России одного из крупнейших производителей разъемов военного и аэрокосмического назначения «JONHON», а так же официальным дистрибьютором и эксклюзивным представителем в России производителя высокотехнологичных и надежных решений для передачи СВЧ сигналов «FORSTAR».



JONHON

«JONHON» (основан в 1970 г.)

Разъемы специального, военного и аэрокосмического назначения:

(Применяются в военной, авиационной, аэрокосмической, морской, железнодорожной, горно- и нефтедобывающей отраслях промышленности)

«FORSTAR» (основан в 1998 г.)

ВЧ соединители, коаксиальные кабели, кабельные сборки и микроволновые компоненты:

(Применяются в телекоммуникациях гражданского и специального назначения, в средствах связи, РЛС, а так же военной, авиационной и аэрокосмической отраслях промышленности).



Телефон: 8 (812) 309-75-97 (многоканальный)

Факс: 8 (812) 320-03-32

Электронная почта: ocean@oceanchips.ru

Web: <http://oceanchips.ru/>

Адрес: 198099, г. Санкт-Петербург, ул. Калинина, д. 2, корп. 4, лит. А