



ATTENTION
OBSERVE PRECAUTIONS
FOR HANDLING
ELECTROSTATIC
DISCHARGE
SENSITIVE
DEVICES

Part Number: AA3535QR4A25Z4S-W2

Warm White

Features

- White SMD package, silicone resin.
- Low thermal resistance.
- Compatible with IR-reflow processes.
- ESD protection.
- Package: 2000pcs / reel.
- Moisture sensitivity level : level 2a.
- RoHS compliant

Descriptions

- The source color devices are made with InGaN on Al₂O₃ substrate Light Emitting Diode.
- Electrostatic discharge and power surge could damage the LEDs.
- It is recommended to use a wrist band or anti-electrostatic glove when handling the LEDs.
- All devices, equipments and machineries must be electrically grounded.

Applications

- Signal and symbol luminaire for orientation.
- Marker lights (e.g. steps, exit ways, etc).
- Decorative and entertainment lighting.
- Commercial and residential lighting.
- Automotive interior lighting.

Package Dimensions

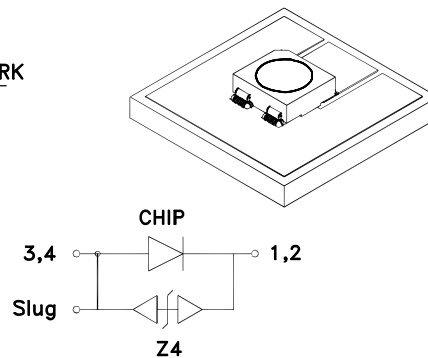
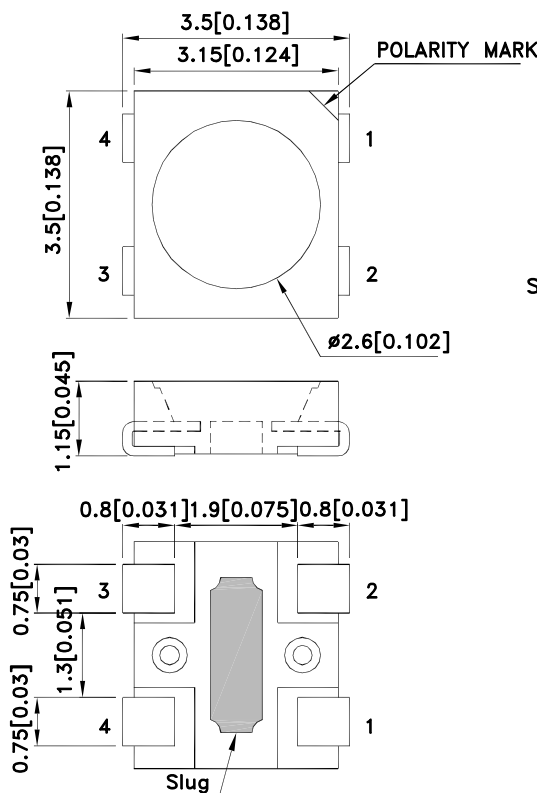

Recommended Soldering Pattern (Units : mm; Tolerance: ±0.1)

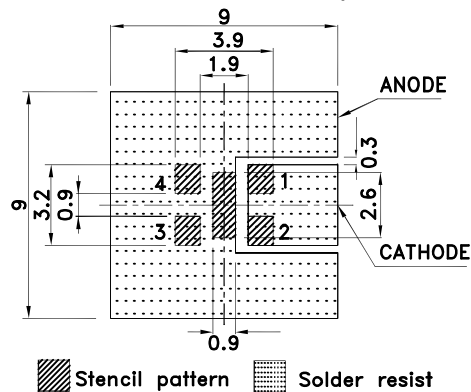

Notes:

1. All dimensions are in millimeters (inches).
2. Tolerance is ±0.25(0.01") unless otherwise noted.
3. The specifications, characteristics and technical data described in the datasheet are subject to change without prior notice.
4. The device has a single mounting surface. The device must be mounted according to the specifications.



Handling Precautions

Compare to epoxy encapsulant that is hard and brittle, silicone is softer and flexible. Although its characteristic significantly reduces thermal stress, it is more susceptible to damage by external mechanical force.

As a result, special handling precautions need to be observed during assembly using silicone encapsulated LED products. Failure to comply might lead to damage and premature failure of the LED.

1. Handle the component along the side surfaces by using forceps or appropriate tools.

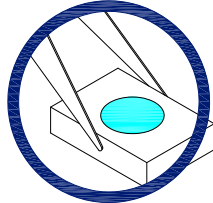

2. Do not directly touch or handle the silicone lens surface. It may damage the internal circuitry.

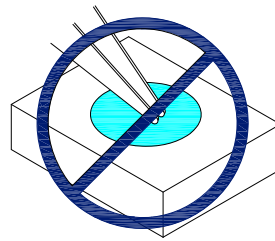
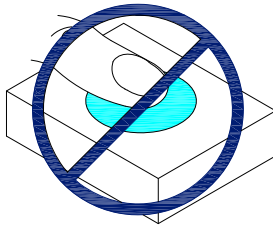

3. Do not stack together assembled PCBs containing exposed LEDs. Impact may scratch the silicone lens or damage the internal circuitry.

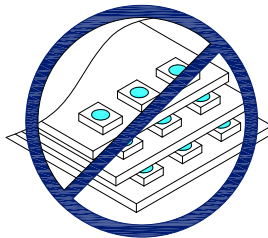

- 4.1. The inner diameter of the SMD pickup nozzle should not exceed the size of the LED to prevent air leaks.
- 4.2. A pliable material is suggested for the nozzle tip to avoid scratching or damaging the LED surface during pickup.
- 4.3. The dimensions of the component must be accurately programmed in the pick-and-place machine to insure precise pickup and avoid damage during production.

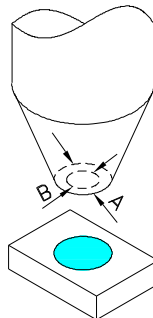

5. As silicone encapsulation is permeable to gases, some corrosive substances such as H_2S might corrode silver plating of leadframe. Special care should be taken if an LED with silicone encapsulation is to be used near such substances.

Selection Guide

Part No.	Color	CCT Range (K)			CRI	Lens Type	Iv (cd) [2] @ 150mA		Φv (lm) [2] @ 150mA*		Viewing Angle [1]
		Min.	Typ.	Max.			Typ.	Min.	Typ.	Min.	
AA3535QR4A25Z4S-W2	Warm White	2870	3000	3220	63	Water Clear	7	9	24	32	2 θ 1/2 120 °

Notes:

1. θ1/2 is the angle from optical centerline where the luminous intensity is 1/2 of the optical peak value.
2. Luminous intensity/ luminous Flux: +/-15%. *LEDs are binned according to their luminous flux.
3. Luminous intensity/ luminous Flux value is traceable to the CIE127-2007 compliant national standards.

Absolute Maximum Ratings at TA=25°C

Parameter	Symbol	Value	Unit
Power Dissipation	P _D	600	mW
Junction Temperature [1]	T _J	110	°C
Operating Temperature	T _{op}	-40 To +85	°C
Storage Temperature	T _{stg}	-40 To +85	°C
DC Forward Current [1]	I _F	150	mA
Peak Forward Current [2]	I _{FM}	300	mA
Reverse Voltage	V _R	5	V
Thermal Resistance [1] (Junction/ambient)	R _{th j-a}	180	°C/W
Thermal Resistance [1] (Junction/solder point)	R _{th j-s}	85	°C/W
Electrostatic Discharge Threshold (HBM)		8000	V

Notes:

1. Results from mounting on PC board FR4 (pad size ≥ 70mm²), mounted on pc board-metal core PCB is recommend for lowest thermal Resistance.
2. 1/10 Duty Cycle, 0.1ms Pulse Width.

Electrical / Optical Characteristics at TA=25°C

Parameter	Symbol	Value	Unit
Forward Voltage I _F = 150mA [Min.]	V _F [1]	2.7	V
Forward Voltage I _F = 150mA [Typ.]		3.5	
Forward Voltage I _F = 150mA [Max.]		4.0	
Allowable Reverse Current [Max.]	I _R	85	mA
Temperature coefficient of V _F I _F =150mA, -10 ° C ≤ T ≤ 100 ° C [Typ.]	TC _v	-3.1	mV/° C
Temperature coefficient of X I _F =150mA, -10 ° C ≤ T ≤ 100 ° C [Typ.]	TC _x	-0.15	10 ⁻³ /° C
Temperature coefficient of Y I _F =150mA, -10 ° C ≤ T ≤ 100 ° C [Typ.]	TC _y	-0.22	10 ⁻³ /° C

Note:

1. Forward Voltage: +/-0.1V.

Wavelength Characteristics $T_a = 25^\circ\text{C}$

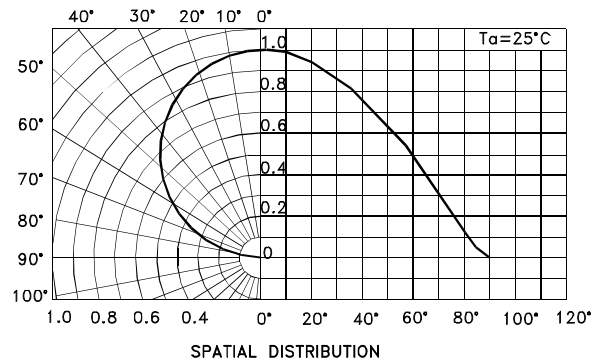
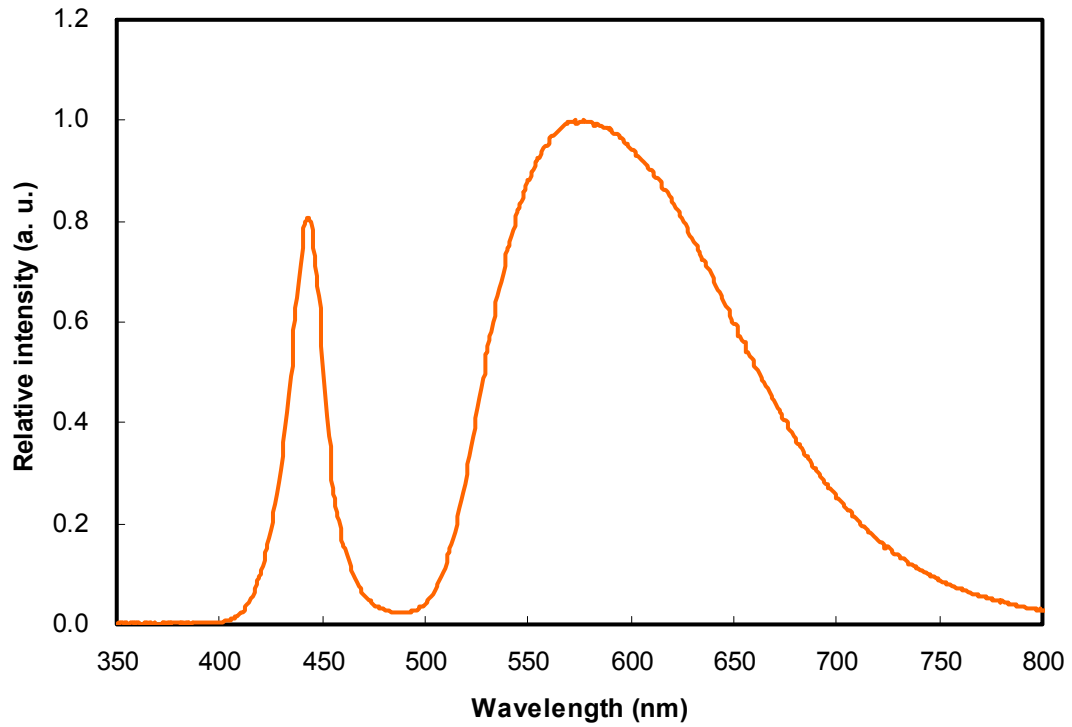

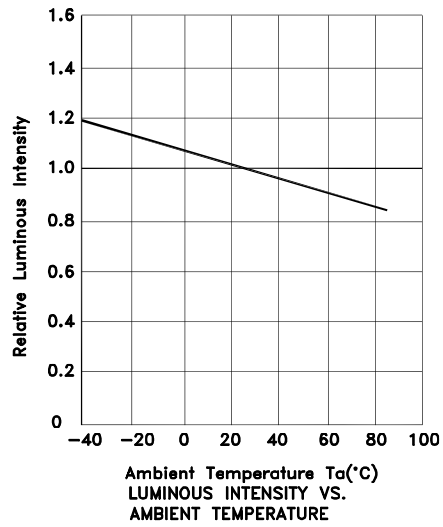
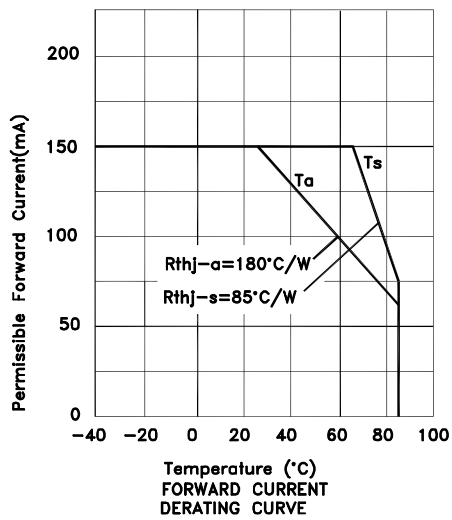
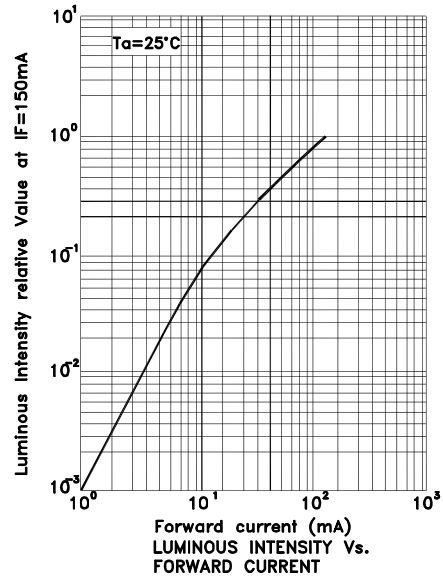
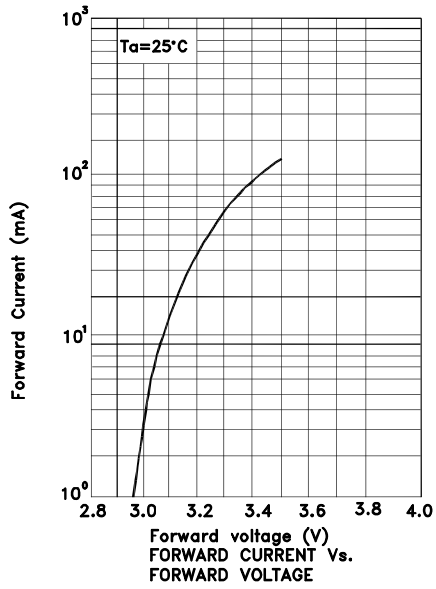

CCT 2500-7000 K Bin Code

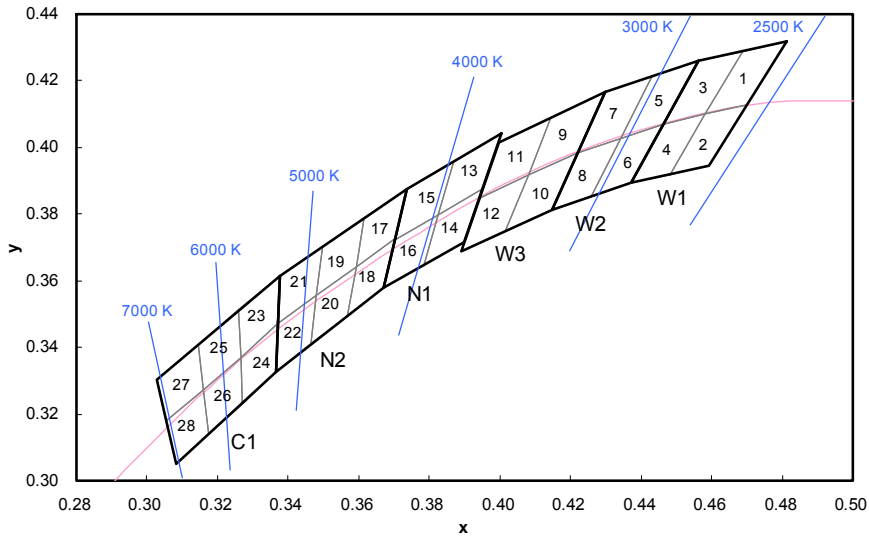

Color	Group	Chromaticity Regions	CCT (K)		
			Min.	Typ.	Max.
Warm White	W1	1, 2, 3, 4	2580	2700	2870
	W2	5, 6, 7, 8	2870	3000	3220
	W3	9, 10, 11, 12	3220	3500	3710
Neutral White	N1	13, 14, 15, 16	3710	4000	4260
	N2	17, 18, 19, 20, 21, 22	4260	4700	5310
Cool White	C1	23, 24, 25, 26, 27, 28	5310	6000	7040

Notes:
 Shipment may contain more than one chromaticity regions. Orders for single chromaticity region are generally not accepted.
 Measurement tolerance of the chromaticity coordinates is ± 0.01 .

	x	y		x	y		x	y		x	y
1	0.4582	0.4099	8	0.4147	0.3814	15	0.3702	0.3722	22	0.3481	0.3557
	0.4687	0.4289		0.4221	0.3984		0.3736	0.3874		0.3370	0.3472
	0.4813	0.4319		0.4342	0.4028		0.3869	0.3958		0.3364	0.3328
	0.4700	0.4126		0.4259	0.3853		0.3825	0.3798		0.3466	0.3411
2	0.4483	0.3919	9	0.4080	0.3916	16	0.3670	0.3578	23	0.3376	0.3616
	0.4582	0.4099		0.4146	0.4089		0.3702	0.3722		0.3260	0.3512
	0.4700	0.4126		0.4299	0.4165		0.3825	0.3798		0.3265	0.3371
3	0.4593	0.3944	10	0.4221	0.3984	17	0.3783	0.3646	24	0.3370	0.3472
	0.4465	0.4071		0.4017	0.3751		0.3736	0.3874		0.3265	0.3371
	0.4562	0.4260		0.4080	0.3916		0.3616	0.3788		0.3270	0.3230
	0.4687	0.4289		0.4221	0.3984		0.3592	0.3641		0.3364	0.3328
4	0.4582	0.4099	11	0.4147	0.3814	18	0.3703	0.3726	25	0.3260	0.3512
	0.4483	0.3919		0.3941	0.3848		0.3592	0.3641		0.3144	0.3408
	0.4465	0.4071		0.3996	0.4015		0.3568	0.3495		0.3160	0.3274
	0.4582	0.4099		0.4146	0.4089		0.3670	0.3578		0.3265	0.3371
5	0.4483	0.3919	12	0.4080	0.3916	19	0.3616	0.3788	26	0.3265	0.3371
	0.4342	0.4028		0.3889	0.3690		0.3496	0.3702		0.3160	0.3274
	0.4430	0.4212		0.3941	0.3848		0.3481	0.3557		0.3175	0.3139
	0.4562	0.4260		0.4080	0.3916		0.3592	0.3641		0.3270	0.3230
6	0.4465	0.4071	13	0.4017	0.3751	20	0.3592	0.3641	27	0.3144	0.3408
	0.4259	0.3853		0.3825	0.3798		0.3481	0.3557		0.3028	0.3304
	0.4342	0.4028		0.3869	0.3958		0.3466	0.3411		0.3055	0.3177
	0.4465	0.4071		0.4006	0.4044		0.3568	0.3495		0.3160	0.3274
7	0.4373	0.3893	14	0.3950	0.3875	21	0.3496	0.3702	28	0.3160	0.3274
	0.4373	0.3893		0.3783	0.3646		0.3376	0.3616		0.3055	0.3177
	0.4221	0.3984		0.3825	0.3798		0.3370	0.3472		0.3081	0.3049
	0.4299	0.4165		0.3950	0.3875		0.3481	0.3557		0.3175	0.3139

AA3535QR4A25Z4S-W2

Reflow soldering is recommended and the soldering profile is shown below.
Other soldering methods are not recommended as they might cause damage to the product.

Reflow Soldering Profile For Lead-free SMT Process.

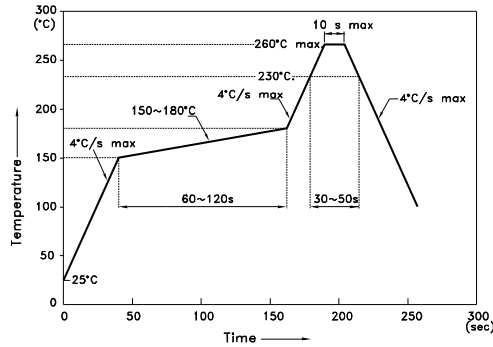

NOTES:

1. We recommend the reflow temperature 245°C(+/-5°C). The maximum soldering temperature should be limited to 260°C.
2. Don't cause stress to the epoxy resin while it is exposed to high temperature.
3. Number of reflow process shall be 2 times or less.

Reel Dimension

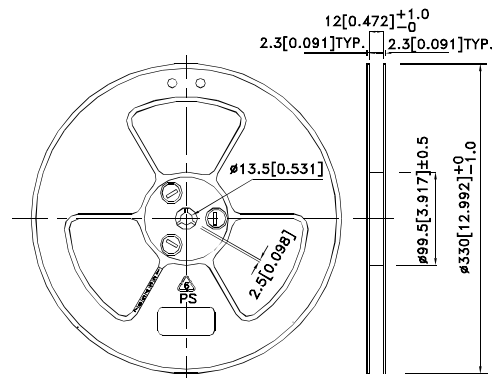

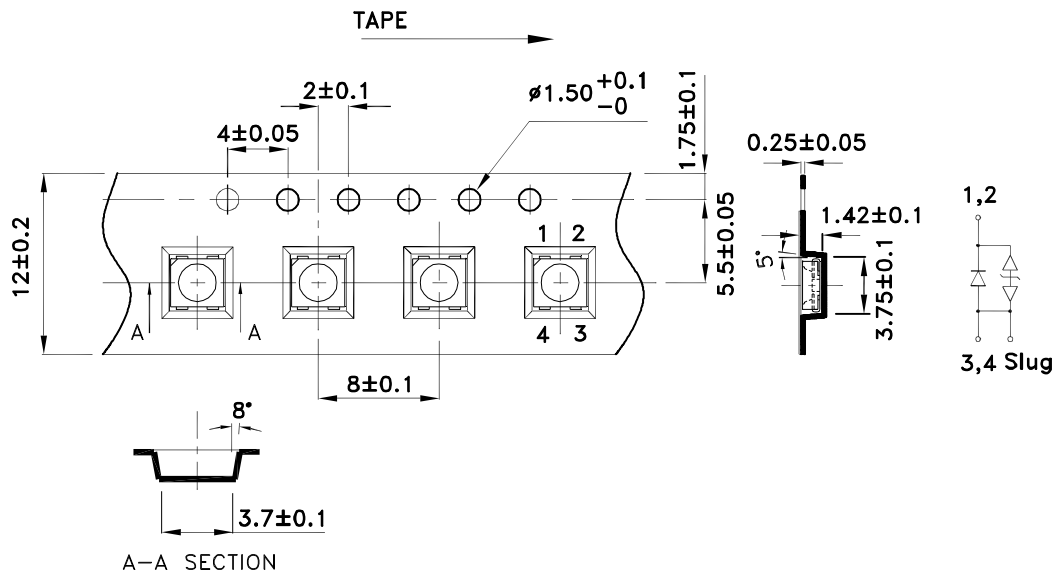

Tape Specifications (Units : mm)

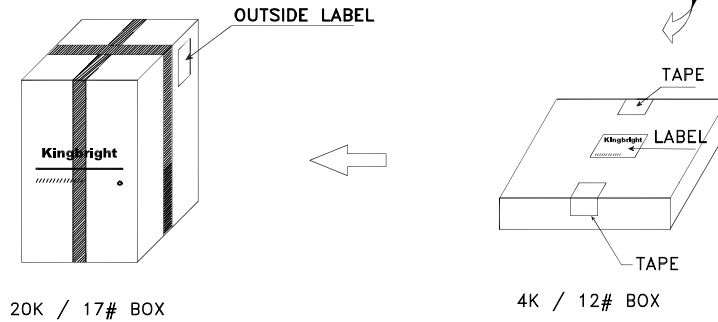
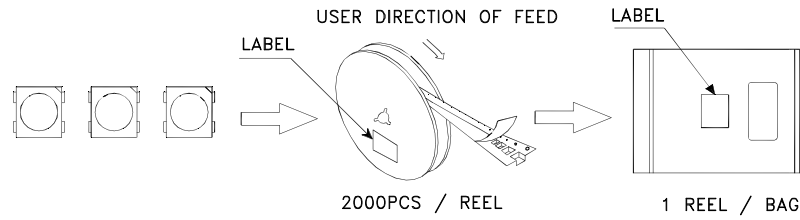

PACKING & LABEL SPECIFICATIONS

AA3535QR4A25Z4S-W2



Kingbright	
P/NO: AA3535xxx	
QTY: 2000 pcs	Q.C. Q C XX XX XXXX PASSED
S/N: XXXX	
CODE: XXX	
LOT NO:	
 XXXXXXXXXXXXXXXXXXXXXXXX	
RoHS Compliant	

Terms and conditions for the usage of this document

1. The information included in this document reflects representative usage scenarios and is intended for technical reference only.
2. The part number, type, and specifications mentioned in this document are subject to future change and improvement without notice. Before production usage customer should refer to the latest datasheet for the updated specifications.
3. When using the products referenced in this document, please make sure the product is being operated within the environmental and electrical limits specified in the datasheet. If customer usage exceeds the specified limits, Kingbright will not be responsible for any subsequent issues.
4. The information in this document applies to typical usage in consumer electronics applications. If customer's application has special reliability requirements or have life-threatening liabilities, such as automotive or medical usage, please consult with Kingbright representative for further assistance.
5. The contents and information of this document may not be reproduced or re-transmitted without permission by Kingbright.
6. All design applications should refer to Kingbright application notes available at <http://www.KingbrightUSA.com/ApplicationNotes>

Компания «Океан Электроники» предлагает заключение долгосрочных отношений при поставках импортных электронных компонентов на взаимовыгодных условиях!

Наши преимущества:

- Поставка оригинальных импортных электронных компонентов напрямую с производств Америки, Европы и Азии, а так же с крупнейших складов мира;
- Широкая линейка поставок активных и пассивных импортных электронных компонентов (более 30 млн. наименований);
- Поставка сложных, дефицитных, либо снятых с производства позиций;
- Оперативные сроки поставки под заказ (от 5 рабочих дней);
- Экспресс доставка в любую точку России;
- Помощь Конструкторского Отдела и консультации квалифицированных инженеров;
- Техническая поддержка проекта, помощь в подборе аналогов, поставка прототипов;
- Поставка электронных компонентов под контролем ВП;
- Система менеджмента качества сертифицирована по Международному стандарту ISO 9001;
- При необходимости вся продукция военного и аэрокосмического назначения проходит испытания и сертификацию в лаборатории (по согласованию с заказчиком);
- Поставка специализированных компонентов военного и аэрокосмического уровня качества (Xilinx, Altera, Analog Devices, Intersil, Interpoint, Microsemi, Actel, Aeroflex, Peregrine, VPT, Syfer, Eurofarad, Texas Instruments, MS Kennedy, Miteq, Cobham, E2V, MA-COM, Hittite, Mini-Circuits, General Dynamics и др.);

Компания «Океан Электроники» является официальным дистрибьютором и эксклюзивным представителем в России одного из крупнейших производителей разъемов военного и аэрокосмического назначения «JONHON», а так же официальным дистрибьютором и эксклюзивным представителем в России производителя высокотехнологичных и надежных решений для передачи СВЧ сигналов «FORSTAR».



JONHON

«JONHON» (основан в 1970 г.)

Разъемы специального, военного и аэрокосмического назначения:

(Применяются в военной, авиационной, аэрокосмической, морской, железнодорожной, горно- и нефтедобывающей отраслях промышленности)

«FORSTAR» (основан в 1998 г.)

ВЧ соединители, коаксиальные кабели,
кабельные сборки и микроволновые компоненты:

(Применяются в телекоммуникациях гражданского и специального назначения, в средствах связи, РЛС, а так же военной, авиационной и аэрокосмической отраслях промышленности).



Телефон: 8 (812) 309-75-97 (многоканальный)

Факс: 8 (812) 320-03-32

Электронная почта: ocean@oceanchips.ru

Web: <http://oceanchips.ru/>

Адрес: 198099, г. Санкт-Петербург, ул. Калинина, д. 2, корп. 4, лит. А