

# HB Series Single Pole Standard Precision Snap-acting Switches

## Features/Benefits

- Low differential travel, high repeatability
- Long life—150,000 cycles typical
- Single and double pole circuitry
- Sealed actuator and case

## Typical Applications

- Thermostats
- Motors
- Industrial controls



## Specifications

CONTACT RATING: From low level\* to 20 AMPS @ 480 V AC; see ELECTRICAL RATING option section for complete listings.  
 ELECTRICAL LIFE: 150,000 cycles at 20 AMPS @ 250 V AC. consult Customer Service Center for typical life at other ratings.  
 INSULATION RESISTANCE: 1,000 M ohm min.  
 DIELECTRIC STRENGTH: 1,500 Vrms min. @ sea level.  
 OPERATING TEMPERATURE: -67°F to 302°F (-55°C to 150°C).  
 OPERATING FORCE: From 4 oz. to 26 oz. max. at actuator button available.  
 MOUNTING SCREWS: Torque 3 in/lbs max. (Note: Exceeding 3 in/lbs torque may change operating characteristics and increase the possibility of cracking switch case).  
 TERMINAL SCREWS: Torque 4 in/lbs max.  
 PANEL MOUNTING BUSHING: Torque 4-6 in/lbs max.  
 DEGREE OF PROTECTION: IP65; Dust-proof, water splash and dew condensation.

\* Low Level=conditions where no arcing occurs during switching, i.e., 0.4 VA max. @ 20 V AC or DC max.

## Materials

SWITCH HOUSING: Heat resistant/electrical grade phenolic.  
 INSERTS: Brass alloy.  
 ACTUATOR BUTTON: Moisture resistant phenolic.  
 SPRING: Copper alloy.  
 PIVOT: Brass alloy.  
 MOVABLE CONTACTS: Gold alloy for ratings 1 AMP or less. Fine silver for ratings greater than 1 AMP and motor load ratings less than 1/2 HP @ 125 V AC. Silver alloy for motor load ratings 1/2 HP @ 125 V AC or greater.  
 STATIONARY CONTACTS: Gold alloy for ratings 1 AMP or less. Fine silver welded to copper base for ratings greater than 1 AMP and motor load ratings less than 1/2 HP @ 125 V AC. Silver alloy on copper base for motor load ratings 1/2 HP @ 125 V AC or greater.  
 TERMINALS: Brass alloy, bright tin plated.

**NOTE:** Specifications and materials listed above are for switches with standard options. For information on specific and custom switches, consult Customer Service Center.

## Build-A-Switch

To order, simply select desired option from each category and place in the appropriate box. Available options are shown and described on pages J-72 through J-76. For additional options not shown in catalog, consult Customer Service Center.

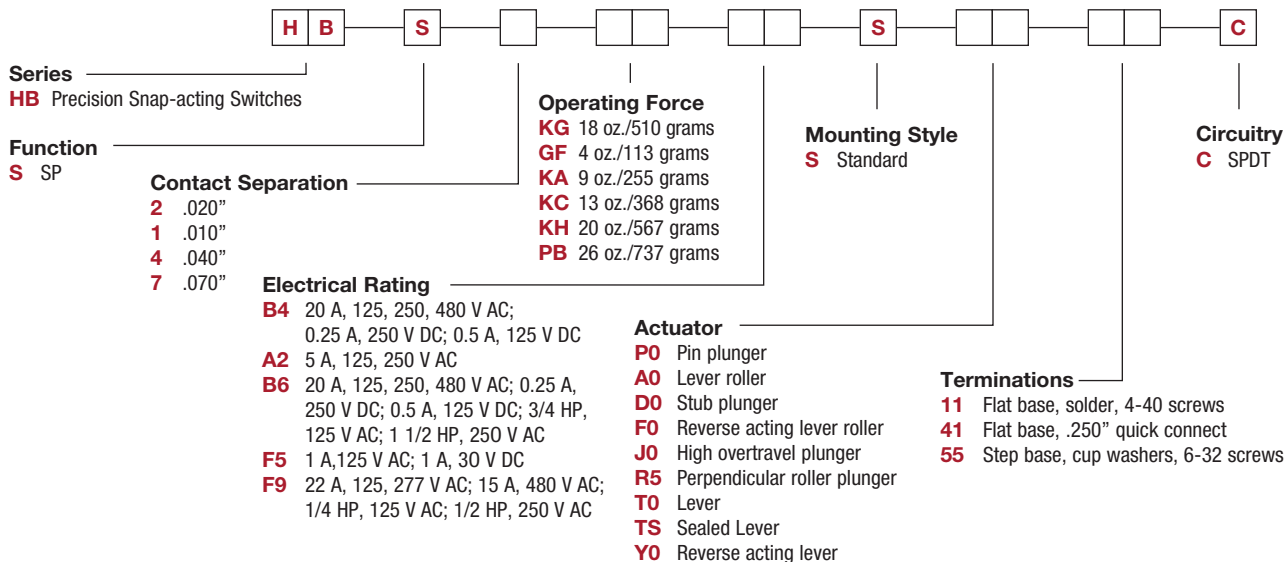

Dimensions are shown: mm  
 Specifications and dimensions subject to change

Snap-acting

# HB Series Single Pole Standard Precision Snap-acting Switches

## Sealed Actuator and Case

To provide reliable service under environmental conditions that might damage standard precision switches, various HB Series switch models are sealed against the entrance of airborne contaminants and/or splashing liquids. The clearance between the operating plunger and the cover is sealed with a silicone boot and the base cover joint is sealed with an epoxy adhesive. These models are designed to meet requirements of IP65 (dust proof, water splash and dew condensation). For additional information on sealed switches, consult our Customer Service Center.

## SERIES

**HB** PRECISION SNAP-ACTING SWITCHES

## FUNCTION

**S** SINGLE POLE SWITCH



Snap-acting

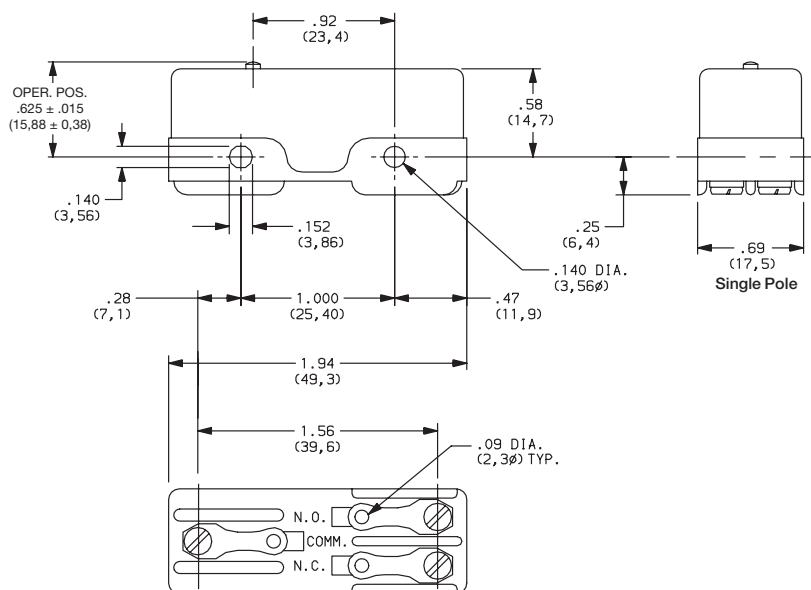

**NOTE:** To select switching function, see CIRCUITRY section, page J-52.

## CONTACT SEPARATION

OPTION CODE	NOMINAL CONTACT SEPARATION (in./mm)
<b>2</b>	.020 (0,51)
<b>1</b>	.010 (0,25)
<b>4</b>	.040 (1,02)
<b>7</b>	.070 (1,78)

Switches with 1 AMP rating (option code 'F5') are available only with .020 contact separation (option '2').

Switches with 1/2 HP, 125 V AC rating or greater (option codes 'B5 and B6') are not available with .010 contact separation (option code '1').

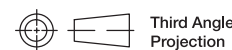
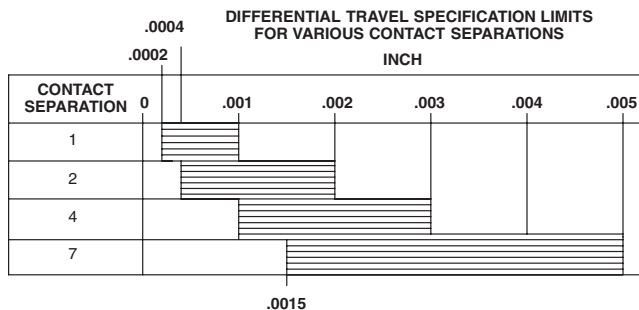

Third Angle Projection

Dimensions are shown: Inch (mm)  
Specifications and dimensions subject to change



# HB Series Single Pole Standard Precision Snap-acting Switches

## OPERATING FORCE

OPTION CODE	MAXIMUM OPERATING FORCE (OZ./GRAMS)	STANDARD CONTACT SEPARATION (inch)
<b>KG</b>	18 510	.020
<b>GF</b>	4 115	.010
<b>KA</b>	9 255	.010
<b>KC</b>	13 370	.020
<b>KH</b>	20 570	.040
<b>PB</b>	26 740	.070

OPERATING FORCE SPECIFICATION LIMITS  
FOR VARIOUS CONTACT SEPARATIONS

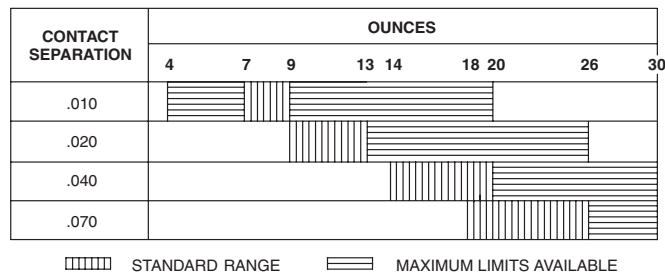

**NOTE:** All listed differential travel characteristics are based on standard operating force and contact separation. For any other force or contact separation, consult Customer Service Center.  
Operating force varies with actuator option, see ACTUATOR option section.

## ELECTRICAL RATING

OPTION CODE	MOVABLE CONTACT	STATIONARY CONTACT	ELECTRICAL RATING
<b>B4</b>	Fine silver.	Fine silver welded to copper base.	20 AMPS @ 125, 250 & 480 V AC; 0.25 AMPS @ 250 V DC; 0.5 AMPS @ 125 V DC (UL).
<b>A2</b>			5 AMPS @ 125 & 250 V AC (UL).
<b>B6</b>	Precious metal alloy.	Precious metal alloy.	20 AMPS @ 125, 250 & 480 V AC; 0.25 AMP @ 250 V DC; 0.5 AMP @ 125 V DC; 3/4 HP @ 125 V AC; 1 1/2 HP @ 250 V AC (UL).
<b>F5</b>	Gold alloy.	Gold alloy.	Low level* to 1 AMP @ 125 V AC; 1 AMP @ 30 V DC (UL).
<b>F9</b>	Fine silver.	Fine silver welded to copper base.	22 AMPS @ 125 & 277 V AC; 15 AMPS @ 480 V AC; 1/4 HP @ 125 V AC; 1/2 HP @ 250 V AC; 277 V AC (UL).

\* Note: See Technical Data section of this catalog for RoHS compliant and compatible definition and specifications.

### AVAILABLE COMBINATIONS

ELECTRICAL RATING	OPERATING FORCE (oz.)					
	4 GF	9 KA	13 KC	18 KG	20 KH	26 PB
A2	•	•	•	•	•	•
B4	x	•	•	•	•	•
B6	x	x	x	•	•	•
F5	x	x	•	•	•	•
F9	x	x	x	•	•	•

• AVAILABLE  
x NOT AVAILABLE

All models  with all options  
Consult Customer Service center for availability and delivery of nonstandard ratings.

\* Low Level=conditions where no arcing occurs during switching, i.e., 0.4 VA max. @ 20 V AC or DC max.

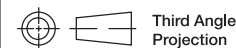

Dimensions are shown: Inch (mm)

Specifications and dimensions subject to change

# HB Series Single Pole Standard Precision Snap-acting Switches

## MOUNTING STYLE

**S** Standard

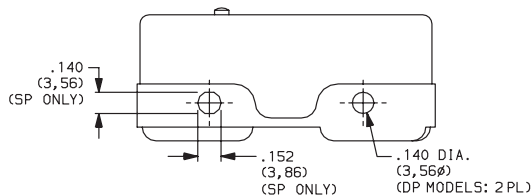

NOTE: Mounting holes will accept pins or screws of .139 dia. (3,53) max. on 1.000 ± .002 (25,4 ± 0,05) centers.

NOTE: Torque mounting screws 3 inlbs max.

## ACTUATOR

OPTION CODE	NO. POLES	FIG.	DIM. A	DIM. B	DIM. C	DIM. D
<b>A0</b>	SP	1	.86 (21,8)	1.120 ± .060 (28,45 ± 1,52)	.38 dia. (9,70)	1.03 (26,2)
<b>D0</b>	SP	3	.92 (23,4)	.844 ± .020 (21,44 ± 0,51)	—	—
<b>F0</b>	SP	2	.09 (2,3)	1.120 ± .050 (28,45 ± 1,27)	.38 dia. (9,70)	.74 (18,8)
<b>J0</b>	SP	4	.86 (21,8)	.860 ± .030 (21,84 ± 0,76)	—	—
<b>P0</b>	SP	5	.92 (23,4)	.625 ± .010 (15,88 ± 0,25)	—	—
<b>R5</b>	SP	6	.92 (23,4)	.62 (15,7)	.50 dia. (12,70)	0.61 (15,5)
<b>T0</b>	SP	7	1.310 (33,27)	.720 ± .060 (18,28 ± 1,52)	1.03 dia. (26,20)	—
<b>TS*</b>	SP	7	1.47 (37,3)	.720 ± .060 (18,28 ± 1,52)	1.03 dia. (26,20)	—
<b>Y0</b>	SP	8	.05 (1,3)	.720 ± .030 (18,29 ± 0,76)	.74 dia. (18,80)	2.65 (6,73)

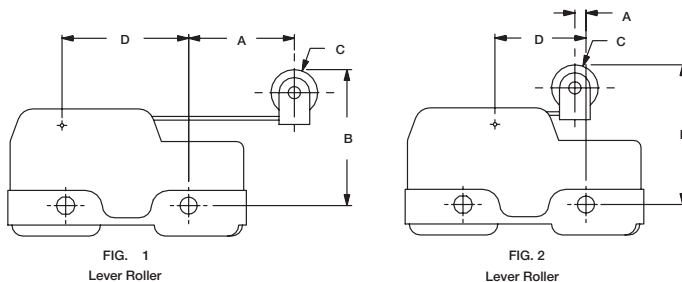

FIG. 1  
Lever Roller

FIG. 2  
Lever Roller

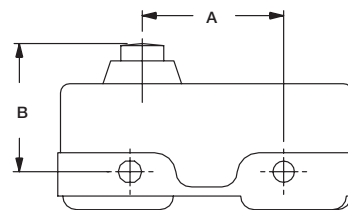

FIG. 3  
Stub Plunger

\* Actuators sealed against the entrance of airborne contaminants and/or splashing liquids.

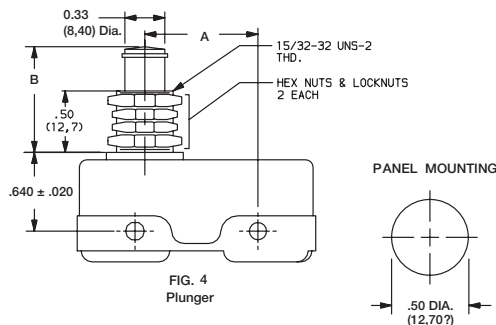

FIG. 4  
Plunger

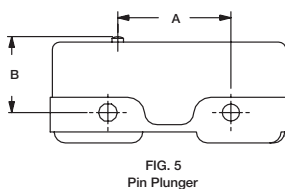

FIG. 5  
Pin Plunger

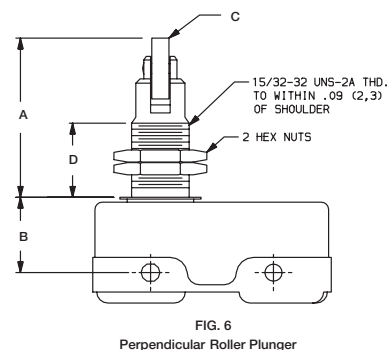

FIG. 6  
Perpendicular Roller Plunger

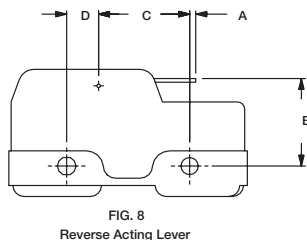

FIG. 8  
Reverse Acting Lever

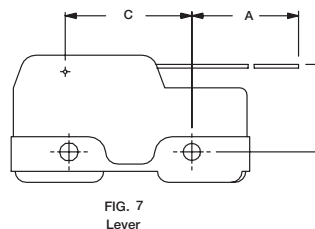

FIG. 7  
Lever



Third Angle Projection

Dimensions are shown: Inches (mm)

Specifications and dimensions subject to change

# HB Series

## Single Pole Standard Precision Snap-acting Switches

### ACTUATOR

	OPTION CODE	ACTUATOR								* SEALED ACTUATOR
		A0	D0	F0	J0	P0	R5	T0	Y0	TS
<b>MAXIMUM OPERATING FORCE (OZ./GRAMS)</b>	GF	—	—	—	—	4 115	—	—	—	—
	KA	3 85	9.5 269	10 284	10 284	9 255	10 284	2 60	10 284	2 56
	KC	—	13 370	10 284	13 370	13 370	13 370	—	10 284	—
	KG	3.5 100	—	—	—	18 510	—	2.5 71	—	2.5 71
	KH	4 115	20 570	20 570	20 570	20 570	20 570	3 85	20 570	3 85
	PB	4.5 130	26 740	20 570	26 740	26 740	26 740	3.5 100	20 570	3.5 100
<b>MINIMUM RELEASE FORCE (OZ./GRAMS)</b>	GF	—	—	—	—	1 28	—	—	—	—
	KA	.75 21	4 110	3 85	4 110	4 110	4 110	.5 14	3 85	.5 14
	KC	1.7 48	4 110	3 85	4 110	4 110	4 110	—	3 85	—
	KG	.75 21	—	—	—	4 110	—	.5 14	—	.5 14
	KH	.75 21	4 110	3 85	4 110	4 110	4 110	.5 14	3 85	.5 14
	PB	.75 21	4 110	3 85	4 110	4 110	4 110	.5 14	3 85	.5 14

**NOTE:** For basic switch operating forces, see page J-71. \* Actuators sealed against the entrance of airborne contaminants and/or splashing liquids.

	OPTION CODE	ACTUATOR								* SEALED ACTUATOR
		A0	D0	F0	J0	P0	R5	T0	Y0	TS
<b>MAXIMUM DIFFERENTIAL TRAVEL (IN/MM)</b>	GF	—	—	—	—	.0005 (0,013)	—	—	—	—
	KA	.020 (0,51)	.0005 (0,013)	.005 (0,13)	—	.0005 (0,013)	—	.047 (1,19)	.005 (0,13)	.047 (1,19)
	KC	—	.002 (0,05)	.008 (0,20)	—	.002 (0,05)	—	—	.009 (0,23)	—
	KG	.062 (1,57)	—	—	—	.003 (0,08)	—	.078 (1,98)	—	.078 (1,98)
	KH	.080 (2,03)	.003 (0,76)	.020 (0,51)	—	.003 (0,08)	—	.093 (2,36)	.020 (0,51)	.093 (2,36)
	PB	.125 (3,18)	.007 (0,18)	.030 (0,76)	—	.005 (0,13)	—	.156 (3,96)	.031 (0,79)	.156 (3,96)
<b>MAXIMUM PRETRAVEL (IN/MM)</b>	GF	—	—	—	—	.020 (0,51)	—	—	—	—
	KA	.312 (7,92)	.020 (0,51)	0.8 (2,0)	.015 (0,38)	.015 (0,38)	.015 (0,38)	.38 (9,7)	.09 (2,3)	.38 (9,7)
	KC	—	.020 (0,51)	0.8 (2,0)	.020 (0,51)	.020 (0,51)	.020 (0,51)	—	.09 (2,3)	—
	KG	.312 (7,92)	—	—	—	.025 (0,64)	—	.38 (9,7)	—	.38 (9,7)
	KH	.38 (9,7)	.025 (0,64)	0.9 (2,3)	.025 (0,64)	.025 (0,64)	.025 (0,64)	.38 (9,7)	0.9 (2,3)	.38 (9,7)
	PB	.38 (9,7)	.030 (0,76)	0.9 (2,3)	.030 (0,76)	.030 (0,76)	.030 (0,76)	.38 (9,7)	0.9 (2,3)	.38 (9,7)
<b>MINIMUM OVERTRAVEL (IN/MM)</b>	GF	—	—	—	—	.005 (0,13)	—	—	—	—
	KA	.156 (3,96)	.055 (1,40)	.06 (1,5)	.22 (5,6)	.005 (0,13)	.141 (3,58)	.19 (4,8)	.06 (1,5)	.19 (4,8)
	KC	—	.055 (1,40)	0.9 (2,3)	.22 (5,6)	.005 (0,13)	.141 (3,58)	—	0.9 (2,3)	—
	KG	.156 (3,96)	—	—	—	.005 (0,13)	—	.19 (4,8)	—	.19 (4,8)
	KH	.156 (3,96)	.055 (1,40)	0.9 (2,3)	.22 (5,6)	.005 (0,13)	.141 (3,58)	.19 (4,8)	0.9 (2,3)	.19 (4,8)
	PB	.156 (3,96)	.055 (1,40)	0.9 (2,3)	.22 (5,6)	.005 (0,13)	.141 (3,58)	.19 (4,8)	0.9 (2,3)	.19 (4,8)

*Dimensions are shown: Inch (mm)  
Specifications and dimensions subject to change*



# HB Series Single Pole Standard Precision Snap-acting Switches

## TERMINATIONS

### 11 FLAT BASE, SOLDER TERMINALS AND 4-40 SCREWS

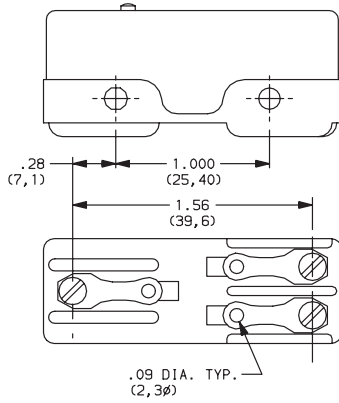

**NOTE:** Switches with flat base option have molded ribs that provide increased creep distance.

### 41 FLAT BASE, .250" QUICK CONNECT TERMINALS

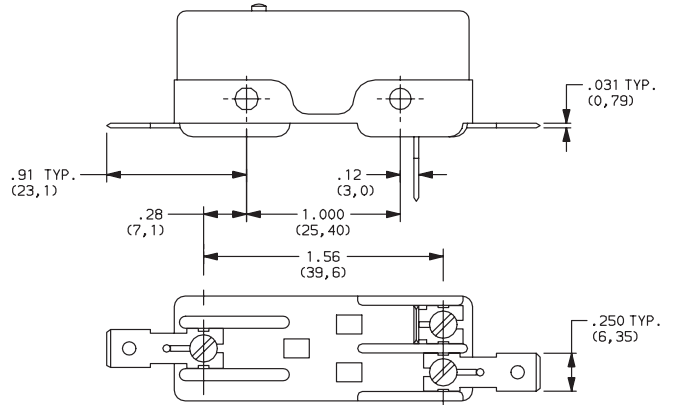

### 55 STEP BASE, 6-32 SCREWS AND CUP WASHERS

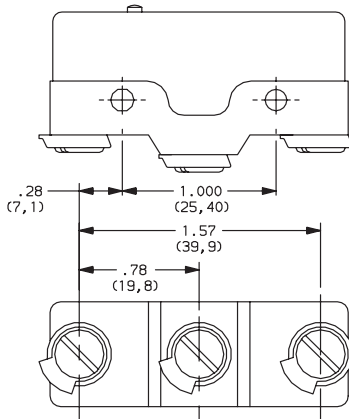

**NOTE:** Switches with step base option provide wide electrical clearance for screw terminal options.

Snap-acting

## CIRCUITRY

### C DT (Double Throw, Normally Closed & Normally Open)



Third Angle  
Projection

Dimensions are shown: Inches (mm)  
Specifications and dimensions subject to change

Компания «Океан Электроники» предлагает заключение долгосрочных отношений при поставках импортных электронных компонентов на взаимовыгодных условиях!

Наши преимущества:

- Поставка оригинальных импортных электронных компонентов напрямую с производств Америки, Европы и Азии, а так же с крупнейших складов мира;
- Широкая линейка поставок активных и пассивных импортных электронных компонентов (более 30 млн. наименований);
- Поставка сложных, дефицитных, либо снятых с производства позиций;
- Оперативные сроки поставки под заказ (от 5 рабочих дней);
- Экспресс доставка в любую точку России;
- Помощь Конструкторского Отдела и консультации квалифицированных инженеров;
- Техническая поддержка проекта, помощь в подборе аналогов, поставка прототипов;
- Поставка электронных компонентов под контролем ВП;
- Система менеджмента качества сертифицирована по Международному стандарту ISO 9001;
- При необходимости вся продукция военного и аэрокосмического назначения проходит испытания и сертификацию в лаборатории (по согласованию с заказчиком);
- Поставка специализированных компонентов военного и аэрокосмического уровня качества (Xilinx, Altera, Analog Devices, Intersil, Interpoint, Microsemi, Actel, Aeroflex, Peregrine, VPT, Syfer, Eurofarad, Texas Instruments, MS Kennedy, Miteq, Cobham, E2V, MA-COM, Hittite, Mini-Circuits, General Dynamics и др.);

Компания «Океан Электроники» является официальным дистрибьютором и эксклюзивным представителем в России одного из крупнейших производителей разъемов военного и аэрокосмического назначения «JONHON», а так же официальным дистрибьютором и эксклюзивным представителем в России производителя высокотехнологичных и надежных решений для передачи СВЧ сигналов «FORSTAR».



## JONHON

«JONHON» (основан в 1970 г.)

Разъемы специального, военного и аэрокосмического назначения:

(Применяются в военной, авиационной, аэрокосмической, морской, железнодорожной, горно- и нефтедобывающей отраслях промышленности)

«FORSTAR» (основан в 1998 г.)

ВЧ соединители, коаксиальные кабели, кабельные сборки и микроволновые компоненты:

(Применяются в телекоммуникациях гражданского и специального назначения, в средствах связи, РЛС, а так же военной, авиационной и аэрокосмической отраслях промышленности).



Телефон: 8 (812) 309-75-97 (многоканальный)

Факс: 8 (812) 320-03-32

Электронная почта: [ocean@oceanchips.ru](mailto:ocean@oceanchips.ru)

Web: <http://oceanchips.ru/>

Адрес: 198099, г. Санкт-Петербург, ул. Калинина, д. 2, корп. 4, лит. А