



Features/Benefits

- Compact design
- Low actuation force
- Detect mechanical movement
- Left and right options
- Right angle options

Typical Applications

- Computer peripherals
- Office equipment
- Consumer electronics
- Appliances
- Audio and visual equipment



PART NUMBER	PACKAGING	SCHEMATIC
DS-02005	1,000 pieces	1P-1T

Specifications

CONTACT ARRANGEMENT: SPST, NO
 CONTACT RATING: 100mA @ 30 VDC
 OPERATING LIFE: 50,000 cycles
 OPERATING FORCE: 50 gf max.
 PRE-TRAVEL: 0.7 mm
 TOTAL TRAVEL: 2.6 mm
 INITIAL CONTACT RESISTANCE: 1 Ω max.
 INSULATION RESISTANCE: 100 M Ω min. @ 100 VDC 60 sec.
 DIELECTRIC STRENGTH: 100 V AC (50-60Hz) 60 sec.
 OPERATING TEMPERATURE: -40°C to +85°C.

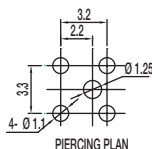
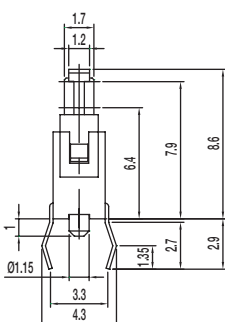
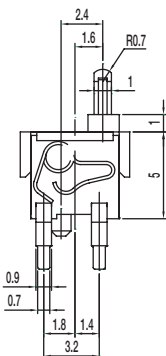

Materials

KNOB: PA
 COVER: PA
 SPRING: Gold plated, copper alloy
 HOUSING: PA
 TERMINAL: Silver plated, copper alloy



PART NUMBER	PACKAGING	SCHEMATIC
DS-02005 (30)	1,000 pieces	1P-1T

Specifications

CONTACT ARRANGEMENT: SPST, NO
 CONTACT RATING: 100mA @ 30 VDC
 OPERATING LIFE: 50,000 cycles
 OPERATING FORCE: 30 gf max.
 PRE-TRAVEL: 0.7 mm
 TOTAL TRAVEL: 2.2 mm
 INITIAL CONTACT RESISTANCE: 1 Ω max.
 INSULATION RESISTANCE: 100 M Ω min. @ 100 VDC 60 sec.
 DIELECTRIC STRENGTH: 100 V AC (50-60Hz) 60 sec.
 OPERATING TEMPERATURE: -40°C to +85°C.

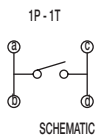
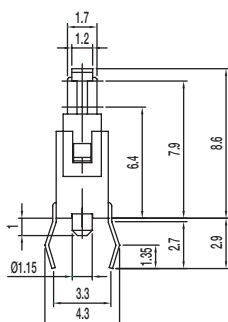

Materials

KNOB: PA
 COVER: PA
 SPRING: Gold plated, copper alloy
 HOUSING: PA
 TERMINAL: Silver plated, copper alloy



Detect

DS Series Detect Switch



PART NUMBER	PACKAGING	SCHEMATIC
DS-02005-A	1,000 pieces	1P-1T N.O.

Specifications

CONTACT ARRANGEMENT: SPST, NO
 CONTACT RATING: 100mA @ 30 VDC
 OPERATING LIFE: 50,000 cycles
 OPERATING FORCE: 50 gf max.
 PRE-TRAVEL: 0.7 mm
 TOTAL TRAVEL: 2.6 mm
 INITIAL CONTACT RESISTANCE: 1 Ω max.
 INSULATION RESISTANCE: 100 M Ω min. @ 100 VDC 60 sec.
 DIELECTRIC STRENGTH: 100 V AC (50-60Hz) 60 sec.
 OPERATING TEMPERATURE: -40°C to +85°C.

Materials

KNOB: PA
 COVER: PA
 SPRING: Gold plated, copper alloy
 HOUSING: PA
 TERMINAL: Silver plated, copper alloy



PART NUMBER	PACKAGING	SCHEMATIC
DS-21805	2,500 pieces	 N.O.

Specifications

CONTACT ARRANGEMENT: SPDT
 CONTACT RATING: 5mA @ 5 VDC
 OPERATING LIFE: 100,000 cycles
 OPERATING FORCE: 36 gf
 TOTAL TRAVEL: 2.20 mm
 INITIAL CONTACT RESISTANCE: 1 Ω max.
 INSULATION RESISTANCE: 100 M Ω min. @ 100 VDC 60 sec.
 DIELECTRIC STRENGTH: 100 V AC (50-60Hz) 60 sec.
 OPERATING TEMPERATURE: -20°C to +70°C.

Materials

KNOB: POM
 COVER: PA46
 SPRING: Silver plated
 HOUSING: PPS
 TERMINAL: Silver plated

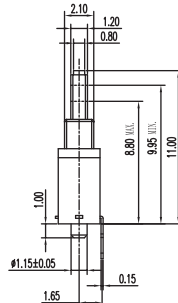
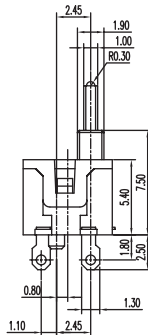
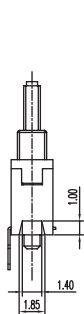
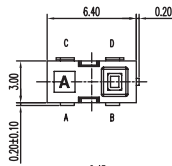

D

Detect



PART NUMBER	PACKAGING	SCHEMATIC
DS-203-A	2,500 pieces	 N.O.

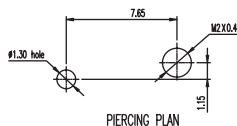
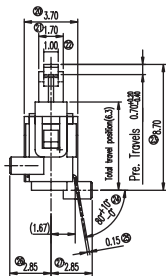
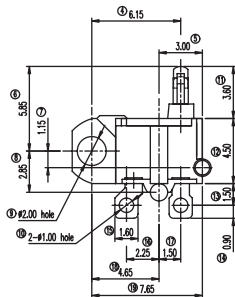
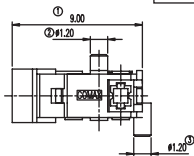

Specifications

CONTACT ARRANGEMENT: SPST
 CONTACT RATING: 100mA @ 30 VDC
 OPERATING LIFE: 50,000 cycles
 OPERATING FORCE: 36 gf
 PRE TRAVEL: 0.70 +0.20/-0.40 mm
 INITIAL CONTACT RESISTANCE: 1 Ω max.
 INSULATION RESISTANCE: 50 M Ω min. @ 250 VDC 60 sec.
 DIELECTRIC STRENGTH: 250 V AC (50-60Hz) 60 sec.
 OPERATING TEMPERATURE: -20°C to +70°C.

Materials

KNOB: POM
 COVER: PA
 SPRING: Gold plated
 HOUSING: PA
 TERMINAL: Silver plated



PART NUMBER	PACKAGING	SCHEMATIC
DS-040-02	1,000 pieces	 N.O.

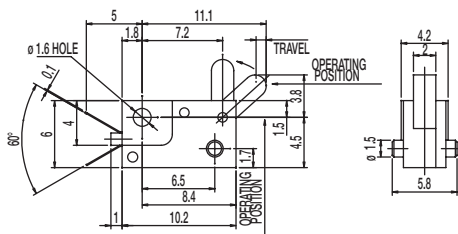
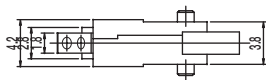

Specifications

CONTACT ARRANGEMENT: SPST, NO
 CONTACT RATING: 0.1A @ 16 VDC
 OPERATING LIFE: 20,000 cycles
 OPERATING FORCE: 30 ± 15 gf
 TRAVEL: 0.90 ± 0.20 mm
 INITIAL CONTACT RESISTANCE: 40 m Ω max.
 INSULATION RESISTANCE: 100 M Ω min. @ 250 VDC 60 sec.
 DIELECTRIC STRENGTH: 250 V AC (50-60Hz) 60 sec.
 OPERATING TEMPERATURE: -20°C to +70°C.

Materials

LEVER: POM
 CASE: PBT
 COVER: PC



DS Series Detect Switch



PART NUMBER	PACKAGING	SCHEMATIC
DS-080	1,000 pieces	1P - 2T 

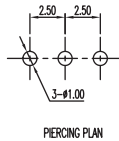
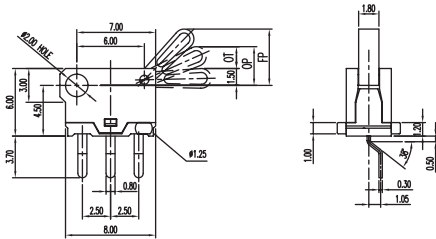
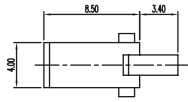

Specifications

CONTACT ARRANGEMENT: SPDT
 CONTACT RATING: 100mA @ 30 VDC
 OPERATING LIFE: 20,000 cycles
 OPERATING FORCE: 30 ± 20 gf
 OVER TRAVEL: 2.0 ± 0.40 mm
 INITIAL CONTACT RESISTANCE: 200 m Ω max.
 INSULATION RESISTANCE: 10 M Ω min. @ 250 VDC 60 sec.
 DIELECTRIC STRENGTH: 250 V AC (50-60Hz) 60 sec.
 OPERATING TEMPERATURE: -20°C to +70°C.

Materials

KNOB: POM
 COVER: PA46
 SLIDER: PBT
 HOUSING: PA46
 TERMINAL: Silver plated



PART NUMBER	PACKAGING	SCHEMATIC
DS-080-C PA	1,000 pieces	1P - 2T 

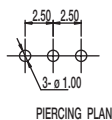
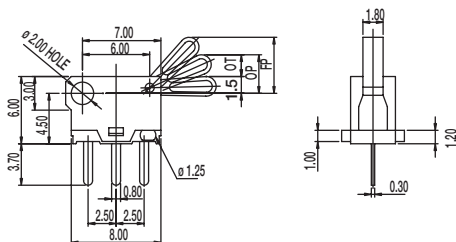
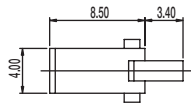

Specifications

CONTACT ARRANGEMENT: SPDT
 CONTACT RATING: 100mA @ 30 VDC
 OPERATING LIFE: 20,000 cycles
 OPERATING FORCE: 30 ± 20 gf
 OVER TRAVEL: 2.0 ± 0.40 mm
 INITIAL CONTACT RESISTANCE: 200 m Ω max.
 INSULATION RESISTANCE: 10 M Ω min. @ 250 VDC 60 sec.
 DIELECTRIC STRENGTH: 250 V AC (50-60Hz) 60 sec.
 OPERATING TEMPERATURE: -20°C to +70°C.

Materials

KNOB: POM
 COVER: PA46
 SLIDER: PBT
 HOUSING: PA46
 TERMINAL: Silver plated



D

Detect



PART NUMBER	PACKAGING	SCHEMATIC
DS-09005-02 BK	500 pieces	 N.O.



Specifications

CONTACT ARRANGEMENT: SPST
 CONTACT RATING: 1mA @ 5 VDC
 OPERATING LIFE: 100,000 cycles
 OPERATING FORCE: 50 gf max.
 TOTAL TRAVEL: 4.5±0.2 mm
 INITIAL CONTACT RESISTANCE: 500 m Ω max.
 INSULATION RESISTANCE: 100 M Ω min. @ 500 VDC 60 sec.
 DIELECTRIC STRENGTH: 500 V AC (50-60Hz) 60 sec.
 OPERATING TEMPERATURE: -20°C to +70°C.

Materials

LEVER: POM
 COVER: PA
 HOUSING: PA
 TERMINAL: Silver plated



PART NUMBER	PACKAGING	SCHEMATIC
DS-09005-02 RP	500 pieces	 N.O.

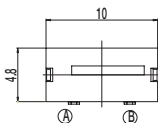

Specifications

CONTACT ARRANGEMENT: SPST
 CONTACT RATING: 1mA @ 5 VDC
 OPERATING LIFE: 100,000 cycles
 OPERATING FORCE: 50 gf max.
 TOTAL TRAVEL: 4.5±0.2 mm
 INITIAL CONTACT RESISTANCE: 500 m Ω max.
 INSULATION RESISTANCE: 100 M Ω min. @ 500 VDC 60 sec.
 DIELECTRIC STRENGTH: 500 V AC (50-60Hz) 60 sec.
 OPERATING TEMPERATURE: -20°C to +70°C.

Materials

LEVER: POM
 COVER: PA
 HOUSING: PA
 TERMINAL: Silver plated



Detect

Компания «Океан Электроники» предлагает заключение долгосрочных отношений при поставках импортных электронных компонентов на взаимовыгодных условиях!

Наши преимущества:

- Поставка оригинальных импортных электронных компонентов напрямую с производств Америки, Европы и Азии, а так же с крупнейших складов мира;
- Широкая линейка поставок активных и пассивных импортных электронных компонентов (более 30 млн. наименований);
- Поставка сложных, дефицитных, либо снятых с производства позиций;
- Оперативные сроки поставки под заказ (от 5 рабочих дней);
- Экспресс доставка в любую точку России;
- Помощь Конструкторского Отдела и консультации квалифицированных инженеров;
- Техническая поддержка проекта, помощь в подборе аналогов, поставка прототипов;
- Поставка электронных компонентов под контролем ВП;
- Система менеджмента качества сертифицирована по Международному стандарту ISO 9001;
- При необходимости вся продукция военного и аэрокосмического назначения проходит испытания и сертификацию в лаборатории (по согласованию с заказчиком);
- Поставка специализированных компонентов военного и аэрокосмического уровня качества (Xilinx, Altera, Analog Devices, Intersil, Interpoint, Microsemi, Actel, Aeroflex, Peregrine, VPT, Syfer, Eurofarad, Texas Instruments, MS Kennedy, Miteq, Cobham, E2V, MA-COM, Hittite, Mini-Circuits, General Dynamics и др.);

Компания «Океан Электроники» является официальным дистрибьютором и эксклюзивным представителем в России одного из крупнейших производителей разъемов военного и аэрокосмического назначения «JONHON», а так же официальным дистрибьютором и эксклюзивным представителем в России производителя высокотехнологичных и надежных решений для передачи СВЧ сигналов «FORSTAR».



JONHON

«JONHON» (основан в 1970 г.)

Разъемы специального, военного и аэрокосмического назначения:

(Применяются в военной, авиационной, аэрокосмической, морской, железнодорожной, горно- и нефтедобывающей отраслях промышленности)

«FORSTAR» (основан в 1998 г.)

ВЧ соединители, коаксиальные кабели, кабельные сборки и микроволновые компоненты:

(Применяются в телекоммуникациях гражданского и специального назначения, в средствах связи, РЛС, а так же военной, авиационной и аэрокосмической отраслях промышленности).



Телефон: 8 (812) 309-75-97 (многоканальный)

Факс: 8 (812) 320-03-32

Электронная почта: ocean@oceanchips.ru

Web: <http://oceanchips.ru/>

Адрес: 198099, г. Санкт-Петербург, ул. Калинина, д. 2, корп. 4, лит. А