



Dual RF LDMOS Bias Controller with Nonvolatile Memory

MAX11008

General Description

The MAX11008 controller biases RF LDMOS power devices found in cellular base stations and other wireless infrastructure equipment. Each controller includes a high-side current-sense amplifier with programmable gains of 2, 10, and 25 to monitor the LDMOS drain current over a range of 20mA to 5A. The MAX11008 supports up to two external diode-connected transistors to monitor the LDMOS temperatures while an internal temperature sensor measures the local die temperature. A 12-bit successive-approximation register (SAR) analog-to-digital converter (ADC) converts the analog signals from the programmable-gain amplifiers (PGAs), external temperature sensors, internal temperature measurement, and two additional auxiliary inputs. The MAX11008 automatically adjusts the LDMOS bias voltages by applying temperature, AIN, and/or drain current samples to data stored in lookup tables (LUTs).

The MAX11008 includes two gate-drive channels, each consisting of a 12-bit DAC to generate the positive gate voltage for biasing the LDMOS devices. Each gate-drive output supplies up to ± 2 mA of gate current. The gate-drive amplifier is current-limited to ± 25 mA and features a fast clamp to AGND.

The MAX11008 contains 4Kb of on-chip, nonvolatile EEPROM organized as 256 bits x 16 bits to store LUTs and register information. The device operates from either a 4-wire 16MHz SPI™-/MICROWIRE™-compatible or an I²C-compatible serial interface.

The MAX11008 operates from a +4.75V to +5.25V analog supply with a typical supply current of 2mA, and a +2.7V to +5.25V digital supply with a typical supply of 3mA. The device is packaged in a 48-pin, 7mm x 7mm, thin QFN package and operates over the extended (-40°C to +85°C) temperature range.

Applications

Cellular Base Stations
 Microwave Radio Links
 Feed-Forward Power Amps
 Transmitters
 Industrial Process Control

SPI is a trademark of Motorola, Inc.

MICROWIRE is a trademark of National Semiconductor Corp.



Maxim Integrated Products 1

For pricing, delivery, and ordering information, please contact Maxim Direct at 1-888-629-4642, or visit Maxim's website at www.maxim-ic.com.

Features

- ◆ On-Chip 4Kb EEPROM for Storing LDMOS Bias Characteristics
- ◆ Integrated High-Side Current-Sense PGA with Gain of 2, 10, or 25
- ◆ $\pm 0.75\%$ Accuracy for Sense Voltage Between +75mV and +1250mV
- ◆ Full-Scale Sense Voltage
 - +100mV with a Gain of 25
 - +250mV with a Gain of 10
 - +1250mV with a Gain of 2
- ◆ Common-Mode Range, LDMOS Drain Voltage: +5V to +32V
- ◆ Adjustable Low-Noise 0 to AV_{DD} Output Gate Bias Voltage Range
- ◆ Fast Clamp to AGND for LDMOS Protection
- ◆ 12-Bit DAC Control of Gate with Temperature
- ◆ Internal Die Temperature Measurement
- ◆ 2-Channel External Temperature Measurement through Remote Diodes
- ◆ Internal 12-Bit ADC Measurement for Temperature, Current, and Voltage Monitoring
- ◆ User-Selectable Serial Interface
 - 400kHz/1.7MHz/3.4MHz I²C-Compatible Interface
 - 16MHz SPI-/MICROWIRE-Compatible Interface

Ordering Information

PART	PIN-PACKAGE	TEMP ERROR (°C)
MAX11008BETM+	48 TQFN-EP*	± 3

+Denotes a lead-free/RoHS-compliant package.

*EP = Exposed pad.

Note: The device is specified over the -40°C to +85°C operating temperature range.

Dual RF LDMOS Bias Controller with Nonvolatile Memory

ABSOLUTE MAXIMUM RATINGS

AV _{DD} to AGND	-0.3V to +6V	SDA/DIN and SCL/SCLK to DGND	-0.3V to +6V
DV _{DD} to DGND	-0.3V to +6V	Continuous Input Current (all terminals).....	±50mA
AGND to DGND.....	-0.3V to +0.3V	Continuous Power Dissipation (T _A = +70°C)	
CS ₊ , CS ₋ to AGND	-0.3V to +34V	48-Pin, 7mm x 7mm, TQFN (derate 27.8mW/°C above	
CS ₊ to CS ₋		+70°C).....	2222.2mW
If CS ₊ > 6V	-0.3V to +6V	Operating Temperature Range	-40°C to +85°C
If CS ₊ ≤ 6V	-0.3V to V _{CS-}	Junction Temperature.....	+150°C
Analog Inputs/Outputs to AGND		Storage Temperature Range	-65°C to +150°C
.....	-0.3V to the lower of (AV _{DD} + 0.3V) and +6V	Lead Temperature (soldering, 10s).....	+300°C
Digital Inputs/Outputs to DGND			
(except SDA/DIN and SCL/SCLK).....			
.....	-0.3V to the lower of (DV _{DD} + 0.3V) and +6V		

Stresses beyond those listed under "Absolute Maximum Ratings" may cause permanent damage to the device. These are stress ratings only, and functional operation of the device at these or any other conditions beyond those indicated in the operational sections of the specifications is not implied. Exposure to absolute maximum rating conditions for extended periods may affect device reliability.

ELECTRICAL CHARACTERISTICS

(V_{CS+} = +32V, AV_{DD} = DV_{DD} = +5V ±5%, external V_{REFADC} = +2.5V, external V_{REFDAC} = +2.5V, C_{REF} = 0.1μF, C_{GATE-} = 0.1nF, V_{SENSE} = V_{CS+} - V_{CS-}, T_A = -40°C to +85°C, unless otherwise noted. Typical values are at T_A = +25°C.)

PARAMETER	SYMBOL	CONDITIONS	MIN	TYP	MAX	UNITS
HIGH-SIDE CURRENT-SENSE PGA						
Common-Mode Input Voltage Range	V _{CS1+} , V _{CS2+}		5		32	V
Common-Mode Rejection Ratio	CMRR	5V < V _{CS+} < 32V		110		dB
CS ₊ Input Bias Current	I _{CS+}	V _{SENSE} < 100mV over the common-mode range		135	195	μA
CS ₋ Input Bias Current	I _{CS-}	V _{SENSE} < 100mV over the common-mode range			±1	μA
Full-Scale Sense Voltage Range	V _{SENSE}	Gain = 25	0		100	mV
		Gain = 10	0		250	
		Gain = 2	0		1250	
Minimum Sense Voltage Range for ±0.75% V _{SENSE} Accuracy		Gain = 25	75		100	mV
		Gain = 10	75		250	
		Gain = 2	75		1250	
Minimum Sense Voltage Range for ±2.5% V _{SENSE} Accuracy		Gain = 25	20		100	mV
		Gain = 10	20		250	
		Gain = 2	20		1250	
Total PGAOUT Voltage Error		V _{SENSE} = 75mV		±0.1	±0.75	%
PGAOUT Capacitive Load	C _{PGAOUT}				50	pF
PGAOUT Settling Time	t _{HSCS}	(Note 1)		< 25		μs
Saturation Recovery Time		Settles to within ±0.5% accuracy from V _{SENSE} = 3 x full scale		< 45		μs

Dual RF LDMOS Bias Controller with Nonvolatile Memory

MAX11008

ELECTRICAL CHARACTERISTICS (continued)

(VCS₊ = +32V, AVDD = DVDD = +5V ±5%, external VREFADC = +2.5V, external VREFDAC = +2.5V, CREF = 0.1μF, CGATE₋ = 0.1nF, VSENSE = VCS₊ - VCS₋, TA = -40°C to +85°C, unless otherwise noted. Typical values are at TA = +25°C.)

PARAMETER	SYMBOL	CONDITIONS	MIN	TYP	MAX	UNITS
LDMOS GATE DRIVER (Gain = 2)						
Output Gate-Drive Voltage Range	VGATE ₋	IGATE ₋ = ±0.1mA	0.1		AVDD - 0.1	V
		IGATE ₋ = ±2mA	0.75		AVDD - 0.75	
Output Impedance	RGATE ₋	Measured at DC		0.1		Ω
GATE ₋ Settling Time	tGATE ₋	RS = 500Ω, CGATE ₋ = 15μF, VGATE ₋ = 0.5V to 4.5V (Note 1)		45		ms
Output Capacitive Load	CGATE ₋	R _{SERIES} = 0Ω	0		0.5	nF
		R _{SERIES} = 500Ω	0	15,000		
GATE ₋ Noise		1kHz to 1MHz		1000		μV _{P-P}
Maximum Power-On Transient				±100		mV
Output Short-Circuit Current Limit	ISC	1s, sinking or sourcing		±25		mA
Total Unadjusted Error	TUE	Worst case at CODE = 4063, use external reference (Note 2)		±7	±25	mV
Total Unadjusted Error without Offset	TUENO_OFFSET	CalCODE = 2457, MaxCODE = 2867, use external reference, TA = +25°C (Note 2)			±8	mV
Drift		Gain = 2, MaxCODE = 2867 (Note 2)		±15		μV/°C
Clamp to Zero Delay		CGATE ₋ = 0.5nF (Note 3)		1		μs
Output-Safe Switch On-Resistance	ROPSW	VGATE ₋ clamped to AGND (Note 4)		300		Ω
MONITOR ADC (DC characteristics)						
Resolution	NADC		12			Bits
Differential Nonlinearity	DNL _{ADC}	(Note 5)	-2		+2	LSB
Integral Nonlinearity	INL _{ADC}				±2	LSB
Offset Error				±2	±4	LSB
Gain Error		(Note 6)		±2	±4	LSB
Gain Temperature Coefficient				±0.4		ppm/°C
Offset Temperature Coefficient				±0.4		ppm/°C
MONITOR ADC DYNAMIC CHARACTERISTICS (1kHz sine-wave input, 2.5V_{P-P}, up to 94.4kpsps)						
Signal-to-Noise Plus Distortion	SINAD			70		dB
Total Harmonic Distortion	THD	Up to 5th harmonic		-82		dBc
Spurious-Free Dynamic Range	SFDR			86		dBc
Intermodulation Distortion	IMD	f _{IN1} = 0.99kHz, f _{IN2} = 1.02kHz		76		dBc
Full-Power Bandwidth		-3dB		1		MHz
Full-Linear Bandwidth		SINAD > 68dB		100		kHz

Dual RF LDMOS Bias Controller with Nonvolatile Memory

ELECTRICAL CHARACTERISTICS (continued)

($V_{CS+} = +32V$, $AV_{DD} = DV_{DD} = +5V \pm 5\%$, external $V_{REFADC} = +2.5V$, external $V_{REFDAC} = +2.5V$, $C_{REF} = 0.1\mu F$, $C_{GATE-} = 0.1nF$, $V_{SENSE} = V_{CS+} - V_{CS-}$, $T_A = -40^{\circ}C$ to $+85^{\circ}C$, unless otherwise noted. Typical values are at $T_A = +25^{\circ}C$.)

PARAMETER	SYMBOL	CONDITIONS	MIN	TYP	MAX	UNITS
MONITOR ADC CONVERSION RATE						
Power-Up Time (External Reference)	t_{PUEXT}			1.1		μs
Power-Up Time (Internal Reference)	t_{PUINT}			70		μs
Acquisition Time	t_{ACQ}			0.5		μs
Conversion Time	t_{CONV}	Internally clocked, $T_A = +25^{\circ}C$			10	μs
Aperture Delay	t_{AD}			20		ns
MONITOR ADC ANALOG INPUT (ADCIN1, ADCIN2)						
Input Voltage Range	V_{ADCIN}	Relative to AGND (Note 7)	0		V_{REFADC}	V
Input Leakage Current		$V_{IN} = 0$ and $V_{IN} = V_{AVDD}$		± 0.01		μA
Input Capacitance	C_{ADCIN}			34		pF
TEMPERATURE MEASUREMENTS						
Internal Sensor Measurement Error		$T_A = +25^{\circ}C$		± 0.25		$^{\circ}C$
		$T_A = T_{MIN}$ to T_{MAX} (Note 8)		± 1.5	± 3	
External Sensor Measurement Error (Note 9)		$T_A = +25^{\circ}C$		± 1		$^{\circ}C$
		$T_A = T_{MIN}$ to T_{MAX}		± 3		
Relative Temperature Accuracy		$T_A = T_{MIN}$ to T_{MAX} (Note 9)		± 0.4		$^{\circ}C$
Temperature Resolution				1/8		$^{\circ}C/LSB$
External Diode Drive Current (Low)			3.25	4		μA
External Diode Drive Current (High)				68	75	μA
INTERNAL REFERENCE						
REFADC/REFDAC Output Voltage	V_{REFADC} , V_{REFDAC}	$T_A = +25^{\circ}C$	2.49	2.50	2.51	V
REFADC/REFDAC Temperature Coefficient	TC_{REFADC} , TC_{REFDAC}			± 15		ppm/ $^{\circ}C$
REFADC/REFDAC Output Impedance				6.5		k Ω
Capacitive Bypass at REFADC/REFDAC			270			pF
Power-Supply Rejection Ratio	PSRR	$AV_{DD} = 5V \pm 5\%$		64		dB
EXTERNAL REFERENCE						
REFADC Input Voltage Range	V_{REFADC}		1.0		AV_{DD}	V
REFADC Input Current	I_{REFADC}	$V_{REFADC} = 2.5V$, $f_{SAMPLE} = 100ksps$		60	80	μA
		Acquisition/between conversions		± 0.01		
REFDAC Input Voltage Range	V_{REFDAC}		0.7		2.5	V
REFDAC Input Current		Static current when the DAC is not calibrated		0.1		μA

Dual RF LDMOS Bias Controller with Nonvolatile Memory

MAX11008

ELECTRICAL CHARACTERISTICS (continued)

($V_{CS+} = +32V$, $AV_{DD} = DV_{DD} = +5V \pm 5\%$, external $V_{REFADC} = +2.5V$, external $V_{REFDAC} = +2.5V$, $C_{REF} = 0.1\mu F$, $C_{GATE-} = 0.1nF$, $V_{SENSE} = V_{CS+} - V_{CS-}$, $T_A = -40^{\circ}C$ to $+85^{\circ}C$, unless otherwise noted. Typical values are at $T_A = +25^{\circ}C$.)

PARAMETER	SYMBOL	CONDITIONS	MIN	TYP	MAX	UNITS
GATE-DRIVER DAC DC ACCURACY						
Resolution	N_{DAC}		12			Bits
Integral Nonlinearity	INL_{DAC}	Measured at GATE_		± 2	± 4	LSB
Differential Nonlinearity	DNL_{DAC}	Guaranteed monotonic (Note 10)			± 1	LSB
DIGITAL INPUTS (SCL/SCLK, SDA/DIN, A0/CS, A1/DOUT, A2/N.C., CNVST, OPSAFE1, OPSAFE2)						
Input High Voltage	V_{IH}	SDA/DIN and SCL/SCLK only	0.7 x DV_{DD}			V
		$A0/\overline{CS}$, A1/DOUT, A2/N.C., \overline{CNVST} , OPSAFE1, OPSAFE2 only	2.3			
Input Low Voltage	V_{IL}	SDA/DIN and SCL/SCLK only	0.3 x DV_{DD}			V
		$A0/\overline{CS}$, A1/DOUT, A2/N.C., \overline{CNVST} , OPSAFE1, OPSAFE2 only	0.7			
Input Hysteresis	V_{HYS}	SDA/DIN and SCL/SCLK only	0.08 x DV_{DD}			V
Input Leakage Current		Digital inputs at 0 or DV_{DD}		± 0.1	± 1	μA
Input Capacitance	C_{IN}			5		pF
DIGITAL OUTPUTS (SDA/DIN, ALARM, BUSY, DOUT)						
Output High Voltage	V_{OH}	ALARM and BUSY only, $I_{SOURCE} = 0.2mA$	$DV_{DD} - 0.4V$			V
Output Low Voltage	V_{OL}	SDA/DIN and A1/DOUT, $I_{SINK} = 3mA$, (Note 11)	0.4			V
		ALARM and BUSY only, $I_{SINK} = 0.3mA$	0.3			
Three-State Leakage	I_{IL}	Digital inputs at 0 or DV_{DD}		± 0.1	± 1	μA
Three-State Capacitance				5		pF
POWER SUPPLIES (Note 12)						
Analog Supply Voltage Range	AV_{DD}		4.75		5.25	V
Digital Supply Voltage Range	DV_{DD}		2.7		$AV_{DD} + 0.3$	V
Analog Supply Current	I_{AVDD}	$AV_{DD} = 5V$		2	4	mA
		Shutdown (Note 13)		0.4	2	μA
Digital Supply Current	I_{DVDD}	$DV_{DD} = 5V$		3	6	mA
		Shutdown		2	32	μA

Dual RF LDMOS Bias Controller with Nonvolatile Memory

SPI TIMING CHARACTERISTICS (Notes 14, 15, Figure 1)

(DV_{DD} = +2.7V to +5.25V, AV_{DD} = +4.75V to +5.25V, VD_{GND} = VAGND = 0, external V_{REFADC} = +2.5V, external V_{REFDAC} = +2.5V, C_{REF} = 0.1μF, T_A = -40°C to +85°C, unless otherwise noted.)

PARAMETER	SYMBOL	CONDITIONS	MIN	TYP	MAX	UNITS
SCLK Clock Period	t _{CP}		62.5			ns
SCLK High Time	t _{CH}		25			ns
SCLK Low Time	t _{CL}		25			ns
DIN to SCLK Rise Setup Time	t _{DS}		15			ns
DIN to SCLK Rise Hold Time	t _{DH}		0			ns
SCLK Fall to DOUT Transition	t _{DO}	C _L = 30pF			20	ns
$\overline{\text{CS}}$ Fall to DOUT Enable	t _{DV}	C _L = 30pF			50	ns
$\overline{\text{CS}}$ Rise to DOUT Disable	t _{TR}	C _L = 30pF (Note 16)			50	ns
$\overline{\text{CS}}$ Rise or Fall to SCLK Rise	t _{CSS}		12.5			ns
$\overline{\text{CS}}$ Pulse-Width High	t _{CSW}		50			ns
Last SCLK Rise to $\overline{\text{CS}}$ Rise	t _{CSH}		0			ns

I²C SLOW-/FAST-MODE TIMING CHARACTERISTICS (Notes 14, 15, Figure 4)

(DV_{DD} = +2.7V to +5.25V, AV_{DD} = +4.75V to +5.25V, VD_{GND} = VAGND = 0, external V_{REFADC} = +2.5V, external V_{REFDAC} = +2.5V, C_{REF} = 0.1μF, T_A = -40°C to +85°C, unless otherwise noted.)

PARAMETER	SYMBOL	CONDITIONS	MIN	TYP	MAX	UNITS
SCL Clock Frequency	f _{SCL}		0		400	kHz
Bus Free Time Between a STOP and START Condition	t _{BUF}		1.3			μs
Hold Time (Repeated) for START Condition	t _{HD:STA}	After this period, the first clock pulse is generated	0.6			μs
Setup Time for a Repeated START Condition	t _{SU:STA}		0.6			μs
SCL Pulse-Width Low	t _{LOW}		1.3			μs
SCL Pulse-Width High	t _{HIGH}		0.6			μs
Data Setup Time	t _{SU:DAT}		100			ns
Data Hold Time	t _{HD:DAT}	(Note 17)	0.004		0.9	μs
SDA, SCL Rise Time	t _R	Receiving (Note 18)	0		300	ns
SDA, SCL Fall Time	t _F	Receiving (Note 18)	0		300	ns
SDA Fall Time	t _F	Transmitting (Notes 18, 19)	20 + 0.1 x C _B		250	ns
Setup Time for STOP Condition	t _{SU:STO}		0.6			μs
Capacitive Load for Each Bus Line	C _B	(Note 20)			400	pF
Pulse Width of Spikes Suppressed by the Input Filter	t _{SP}	(Note 21)			50	ns

Dual RF LDMOS Bias Controller with Nonvolatile Memory

MAX11008

I²C HIGH-SPEED-MODE TIMING CHARACTERISTICS (Notes 14, 15, Figure 4)

(DV_{DD} = +2.7V to +5.25V, AV_{DD} = +4.75V to +5.25V, VD_{GND} = VAGND = 0, external V_{REFADC} = +2.5V, external V_{REFDAC} = +2.5V, C_{REF} = 0.1μF, T_A = -40°C to +85°C, unless otherwise noted.)

PARAMETER	SYMBOL	CONDITIONS	C _B = 100pF max		C _B = 400pF		UNITS
			MIN	MAX	MIN	MAX	
Serial Clock Frequency	f _{SCL}		0	3.4	0	1.7	MHz
Setup Time (Repeated) START Condition	t _{SU:STA}		160		160		ns
Hold Time (Repeated) START Condition	t _{HD:STA}		160		160		ns
SCL Pulse-Width Low	t _{LOW}		160		320		ns
SCL Pulse-Width High	t _{HIGH}		80		120		ns
Data Setup Time	t _{SU:DAT}		10		10		ns
Data Hold Time	t _{HD:DAT}	(Note 17)	4	70	4	150	ns
SCL Rise Time	t _{RCL}		10	40	20	80	ns
SCL Rise Time	t _{RCL1}	After a repeated START condition and after an acknowledge bit	10	80	20	160	ns
SCL Fall Time	t _{FCL}		10	40	20	80	ns
SDA Rise Time	t _{RDA}		10	80	20	160	ns
SDA Fall Time	t _{FDA}		10	80	20	160	ns
Setup Time for STOP Condition	t _{SU:STO}		160		160		ns
Capacitive Load for Each Bus Line	C _B	(Note 20)		100		400	ns
Pulse Width of Spikes Suppressed by the Input Filter	t _{SP}	(Note 21)	0	10	0	10	ns

MISCELLANEOUS TIMING CHARACTERISTICS (Note 15)

(DV_{DD} = +2.7V to +5.25V, AV_{DD} = +4.75V to +5.25V, VD_{GND} = VAGND = 0, external V_{REFADC} = +2.5V, external V_{REFDAC} = +2.5V, C_{REF} = 0.1μF, T_A = -40°C to +85°C, unless otherwise noted.)

PARAMETER	SYMBOL	CONDITIONS	MIN	TYP	MAX	UNITS
Minimum Time to Wait After a Write Command Before Reading Back Data from the Same Location	t _{RDBK}	(Note 22)		1		μs
CNVST Active-Low Pulse Width in ADC Clock Mode 01	t _{CNV01}		20			ns
CNVST Active-Low Pulse Width in ADC Clock Mode 11 to Initiate a Temperature Conversion	t _{CNV11}		20			ns
CNVST Active-Low Pulse Width in ADC Clock Mode 11 for ADCIN1/2 Acquisition	t _{ACQ11A}		1.5			μs
ADC Power-Up Time (External Reference)	t _{APUEXT}			1.1		μs
ADC Power-Up Time (Internal Reference)	t _{APUINT}			70		μs

Dual RF LDMOS Bias Controller with Nonvolatile Memory

MISCELLANEOUS TIMING CHARACTERISTICS (Note 15) (continued)

(DV_{DD} = +2.7V to +5.25V, AV_{DD} = +4.75V to +5.25V, VD_{GND} = VAGND = 0, external V_{REFADC} = +2.5V, external V_{REFDAC} = +2.5V, C_{REF} = 0.1μF, T_A = -40°C to +85°C, unless otherwise noted.)

PARAMETER	SYMBOL	CONDITIONS	MIN	TYP	MAX	UNITS
DAC Power-Up Time (External Reference)	t _{DPUEXT}			2		μs
DAC Power-Up Time (Internal Reference)	t _{DPUINT}			70		μs
Acquisition Time (Internally Timed in ADC Clock Modes 00 or 01)	t _{ACQ}				0.6	μs
Conversion Time (Internally Clocked)	t _{CONV}	Internally clocked, T _A = +25°C			10	μs
Delay to Start of Conversion Time	t _{CONVW}	(Note 23)		1.3		μs
Temperature Conversion Time (Internally Clocked)	t _{CONVT}			70		μs

Note 1: Output settles to within ±0.5% of final value.

Note 2: Total unadjusted errors are for the entire gate-drive channel including the 12-bit DAC, and the gate driver is measured at the GATE1 and GATE2 outputs.

Note 3: V_{GATE_} = V_{DD} - 0.1. Measured from when OPSAFE1 or OPSAFE2 is set high.

Note 4: During power-on-reset, the output safe switch is closed. The output safe switch is opened under user software control.

Note 5: Guaranteed to be 11 bits linearly accurate.

Note 6: Offset nulled.

Note 7: The absolute range for analog inputs is from 0 to V_{AVDD}.

Note 8: Internal temperature-sensor performance is guaranteed by design.

Note 9: The MAX11008 and the external sensor are at the same ambient temperature. External sensor measurement error is tested with a diode-connected 2N3904.

Note 10: Guaranteed monotonicity. Accuracy is degraded at lower V_{REFDAC}.

Note 11: SDA/DIN is an open-drain output only when in I²C mode. A1/DOUT is an open-drain output only when in SPI mode.

Note 12: Supply-current limits are valid only when digital inputs are set to DGND or supply voltage. Timing specifications are only guaranteed when inputs are driven rail-to-rail.

Note 13: Shutdown supply currents are typically 0.4μA for AV_{DD}; maximum specification is limited by automated test equipment.

Note 14: All times are referred to the 50% point between V_{IH} and V_{IL} levels.

Note 15: Guaranteed by design. Not production tested.

Note 16: DOUT will go into three-state mode after the \overline{CS} rising edge. Keep \overline{CS} low long enough for the DOUT value to be sampled before it goes to three-state.

Note 17: A master device must provide a hold time of at least 300ns for the SDA signal (referred to V_{IL} of the SCL signal) to bridge the undefined region of SCL's falling edge.

Note 18: t_R and t_F measured between 0.3 × DV_{DD} and 0.7 × DV_{DD}.

Note 19: C_B = total capacitance of one bus line in pF. For bus loads between 100pF and 400pF, the timing parameters should be linearly interpolated.

Note 20: An appropriate bus pullup resistance must be selected depending on board capacitance.

Note 21: Input filters on the SDA and SCL inputs suppress noise spikes less than 50ns.

Note 22: When a command is written to the serial interface, the command is passed by the internal oscillator clock and executed. There is a small synchronization delay before the new value is written to the appropriate register. If the serial interface attempts to read the new value back before t_{RDBK}, the new data is not corrupted; however, the result of the read command may not reflect the new value.

Note 23: This is the minimum time from the end of a command before \overline{CNVST} should be asserted. The time allows for the data from the preceding write to arrive and set up the chip in preparation for the CNVST. The time need only be observed when the write affects the ADC controls. Failure to observe this time may lead to incorrect conversions (for example, conversion of the wrong ADC channel).

Dual RF LDMOS Bias Controller with Nonvolatile Memory

MAX11008

Typical Operating Characteristics

($AV_{DD} = DV_{DD} = 5V$, external $V_{REFADC} = 2.5V$, external $V_{REFDAC} = 2.5V$, $V_{CS-} = V_{CS+} = 32V$, $C_{REF} = 0.1\mu F$, $T_A = +25^\circ C$, unless otherwise noted.)

ANALOG SUPPLY CURRENT vs. SUPPLY VOLTAGE

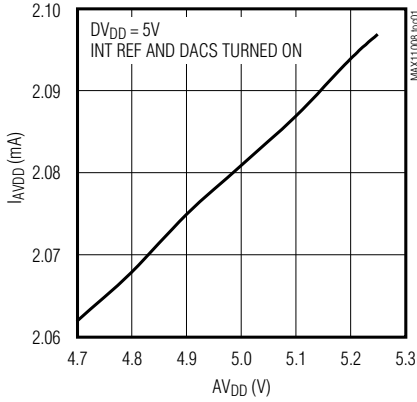

DIGITAL SUPPLY CURRENT vs. SUPPLY VOLTAGE

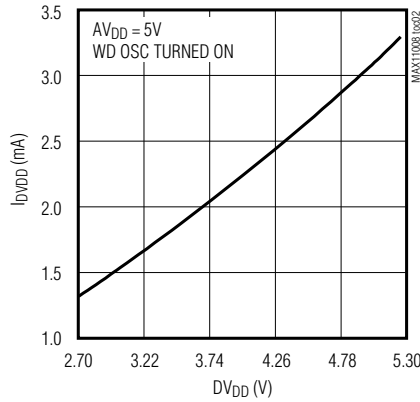

CURRENT-SENSE AMPLIFIER OUTPUT ERROR vs. TEMPERATURE (G = 2)

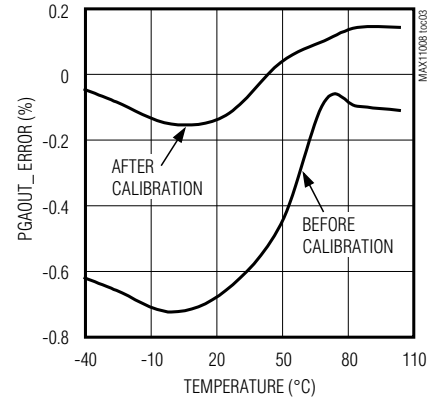

CURRENT-SENSE AMPLIFIER OUTPUT ERROR vs. TEMPERATURE (G = 10)

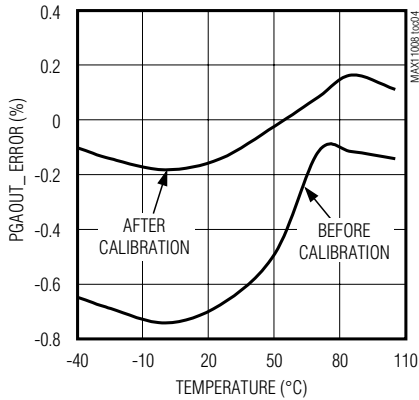

CURRENT-SENSE AMPLIFIER OUTPUT ERROR vs. TEMPERATURE (G = 25)

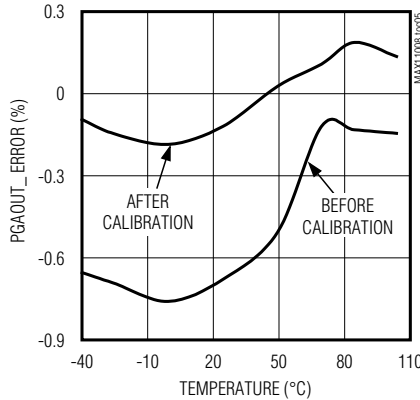

CURRENT-SENSE AMPLIFIER OUTPUT ERROR vs. SENSE VOLTAGE (G = 2)

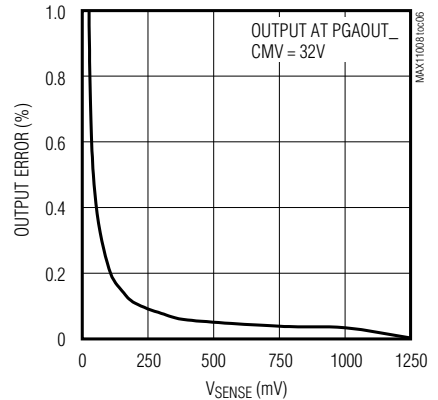

CURRENT-SENSE AMPLIFIER OUTPUT ERROR vs. SENSE VOLTAGE (G = 10)

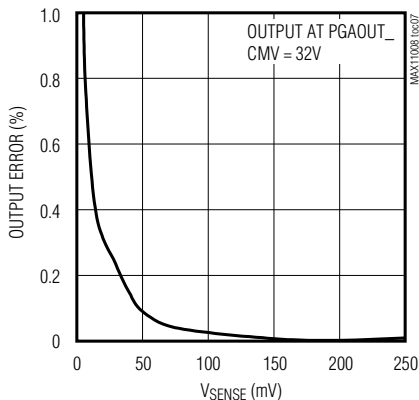

CURRENT-SENSE AMPLIFIER OUTPUT ERROR vs. SENSE VOLTAGE (G = 25)

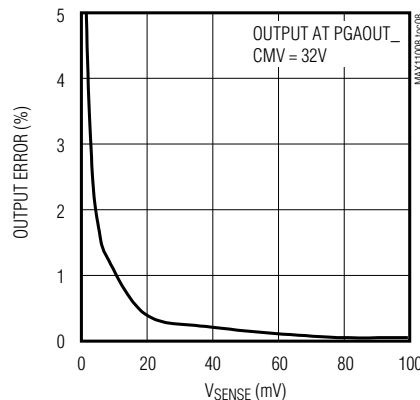

CURRENT-SENSE AMPLIFIER OUTPUT ERROR vs. CMV

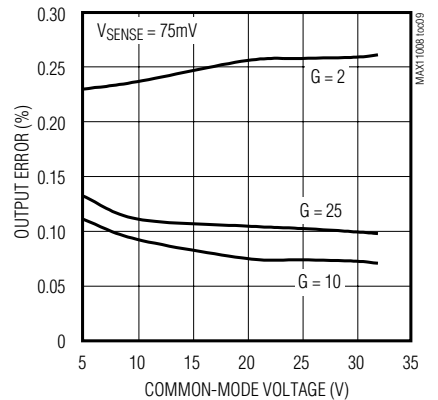

Dual RF LDMOS Bias Controller with Nonvolatile Memory

Typical Operating Characteristics (continued)

($V_{DD} = DV_{DD} = 5V$, external $V_{REFADC} = 2.5V$, external $V_{REFDAC} = 2.5V$, $V_{CS-} = V_{CS+} = 32V$, $C_{REF} = 0.1\mu F$, $T_A = +25^\circ C$, unless otherwise noted.)

CURRENT-SENSE TRANSIENT RESPONSE (G = 2)

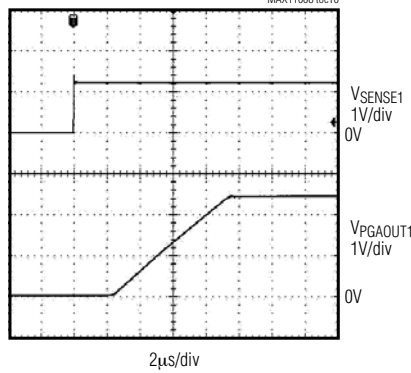

CURRENT-SENSE TRANSIENT RESPONSE (G = 10)

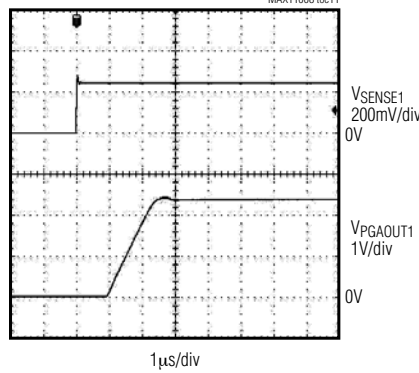

CURRENT-SENSE TRANSIENT RESPONSE (G = 25)

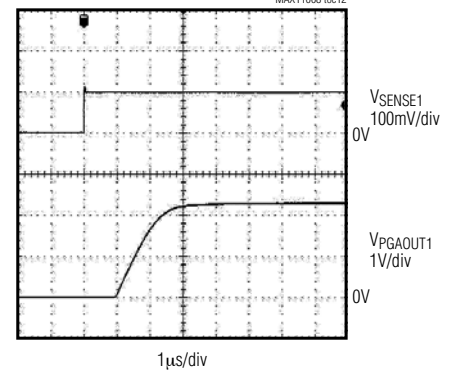

GATE VOLTAGE TOTAL UNADJUSTED ERROR vs. TEMPERATURE

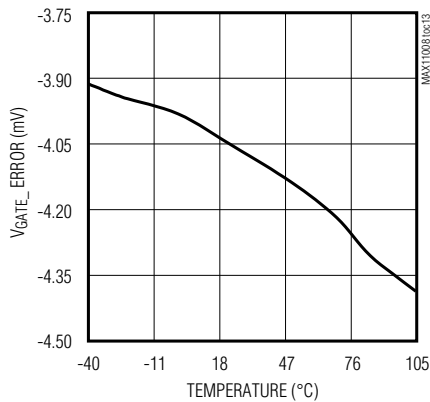

GATE POWER-UP TIME

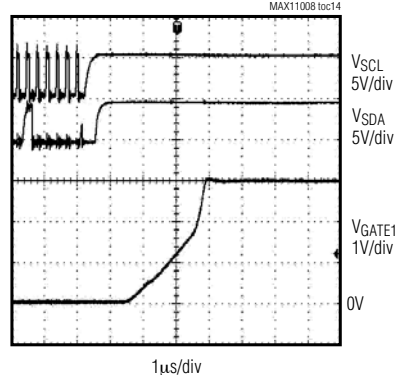

GATE_ SETTling TIME vs. C_GATE

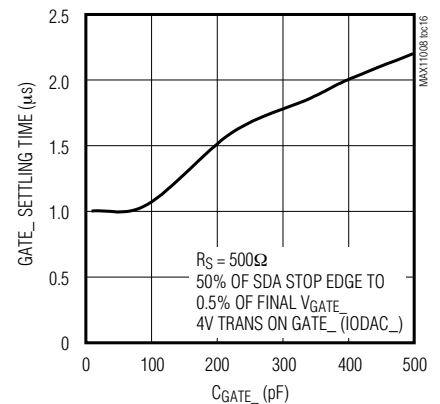

MAJOR CARRY TRANSITION GLITCH

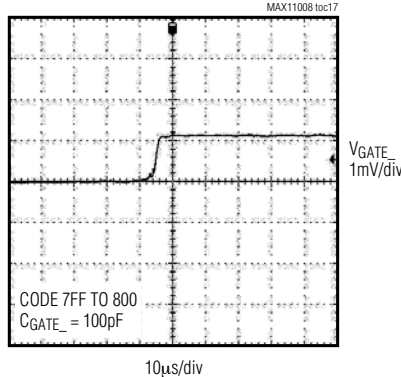

DAC INTEGRAL NONLINEARITY vs. INPUT CODE

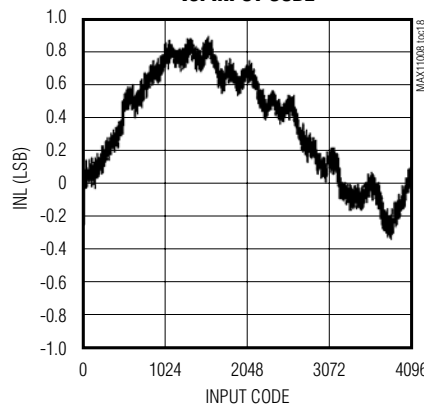

DAC DIFFERENTIAL NONLINEARITY vs. INPUT CODE

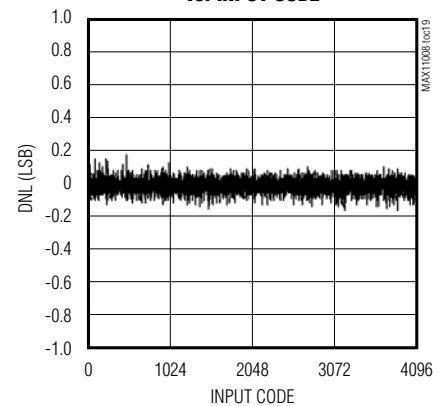

Dual RF LDMOS Bias Controller with Nonvolatile Memory

MAX11008

Typical Operating Characteristics (continued)

($A_{V_{DD}} = DV_{DD} = 5V$, external $V_{REFADC} = 2.5V$, external $V_{REFDAC} = 2.5V$, $V_{CS_-} = V_{CS_+} = 32V$, $C_{REF} = 0.1\mu F$, $T_A = +25^\circ C$, unless otherwise noted.)

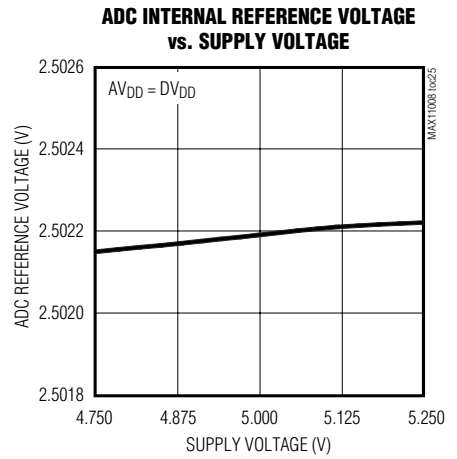
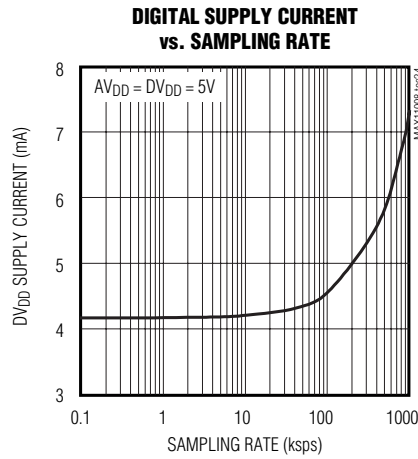
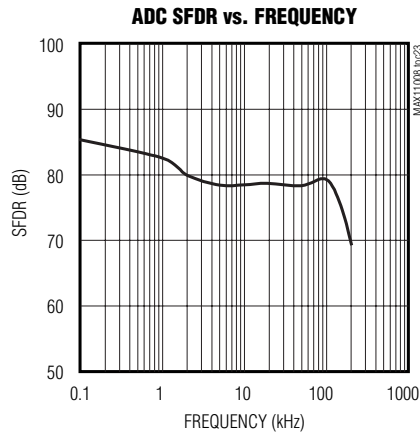
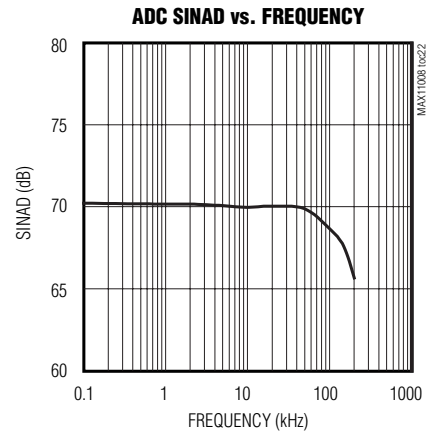
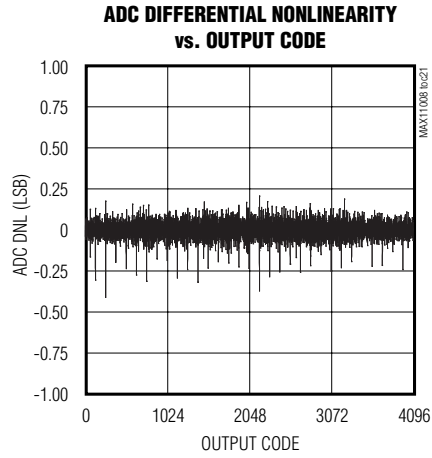
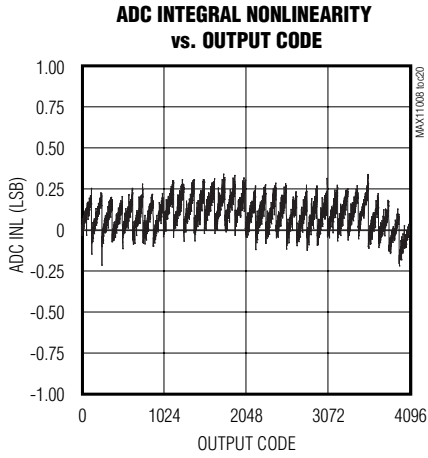

Dual RF LDMOS Bias Controller with Nonvolatile Memory

Typical Operating Characteristics (continued)

($AV_{DD} = DV_{DD} = 5V$, external $V_{REFADC} = 2.5V$, external $V_{REFDAC} = 2.5V$, $V_{CS-} = V_{CS+} = 32V$, $C_{REF} = 0.1\mu F$, $T_A = +25^\circ C$, unless otherwise noted.)

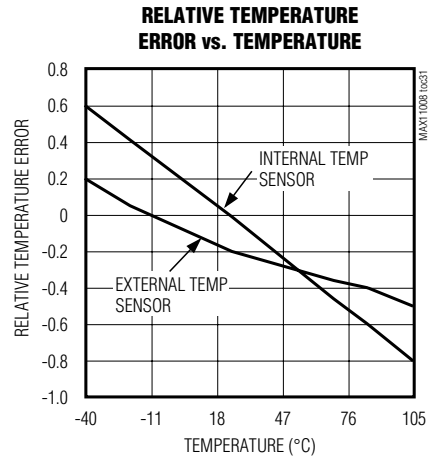
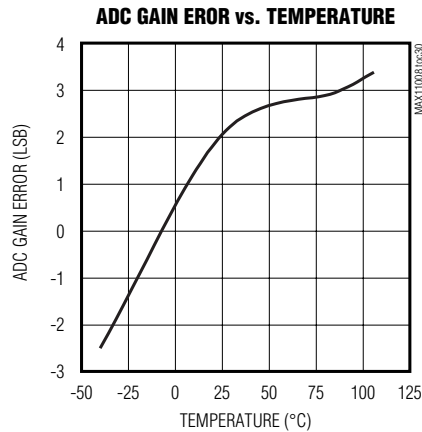
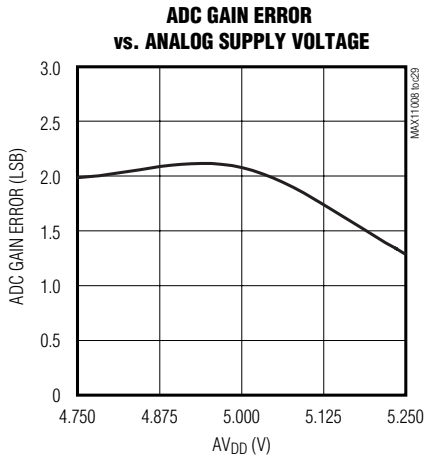
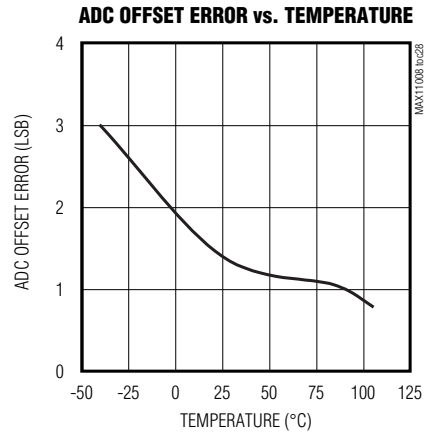
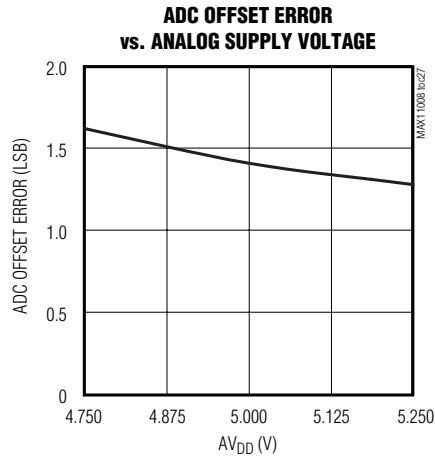
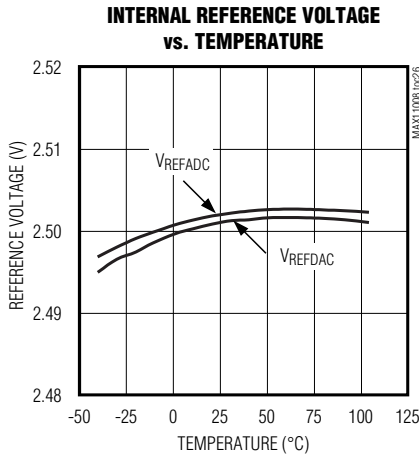

Dual RF LDMOS Bias Controller with Nonvolatile Memory

Pin Description

MAX11008

PIN	NAME	FUNCTION
1, 31	DGND	Digital Ground. Connect both DGND inputs to the same potential.
2	OPSAFE1	Output Safe Switch Logic Input 1. Drive OPSAFE1 high to close the output safe switch and clamp GATE1 to AGND. Drive OPSAFE1 low to open the switch.
3	A0/ \overline{CS}	Address-Select Input 0/Chip-Select Input. In I ² C mode, this is the address-select input 0. See Table 1. In SPI mode, this is the chip-select input.
4	\overline{CNVST}	Active-Low Conversion Start Input. Drive \overline{CNVST} low to begin a conversion when in clock modes 01 and 11.
5	SPI/I ² C	Interface-Select Input. Connect to DGND for I ² C interface. Connect to DV _{DD} for SPI interface.
6	ALARM	Alarm Output
7	OPSAFE2	Output Safe Switch Logic Input 2. Drive OPSAFE2 high to close the output safe switch and clamp GATE2 to AGND. Drive OPSAFE2 low to open the switch.
8	REFDAC	DAC Reference Input/Output
9	REFADC	ADC Reference Input/Output
10	DXP1	Temperature Diode Positive Input 1. Connect DXP1 to the anode of the external diode.
11	DXN1	Temperature Diode Negative Input 1. Connect DXN1 to the cathode of the external diode.
12	DXP2	Temperature Diode Positive Input 2. Connect DXP2 to the anode of the external diode.
13	DXN2	Temperature Diode Negative Input 2. Connect DXN2 to the cathode of the external diode.
14	ADCIN1	ADC Auxiliary Input 1
15	ADCIN2	ADC Auxiliary Input 2
16	PGAOUT2	Programmable-Gain Amplifier Output 2
17	GATE2	Gate-Drive Amplifier Output 2
18	GATE1	Gate-Drive Amplifier Output 1
19, 25, 30, 34–39, 42, 48	N.C.	No Connection. Not internally connected. Leave unconnected.
20, 24	AV _{DD}	Analog-Supply Input. Connect both AV _{DD} inputs to the same potential.
21, 22, 23	AGND	Analog Ground. Connect all AGND inputs to the same potential.
26	CS2+	Current-Sense Positive Input 2. CS2+ is the external sense-resistor connection to the LDMOS 2 supply.
27	CS2-	Current-Sense Negative Input 2. CS2- is the external sense-resistor connection to the LDMOS 2 drain.
28	CS1-	Current-Sense Negative Input 1. CS1- is the external sense-resistor connection to the LDMOS 1 drain.
29	CS1+	Current-Sense Positive Input 1. CS1+ is the external sense-resistor connection to the LDMOS 1 supply.
32, 33, 47	DV _{DD}	Digital-Supply Input. Connect all DV _{DD} inputs to the same potential. Connect a 0.1 μ F capacitor to DV _{DD} .
40	PGAOUT1	Programmable-Gain Amplifier Output 1
41	A2/N.C.	Address-Select Input 2/N.C. In I ² C mode, this pin is the address-select input 2. See Table 1. In SPI mode, this is a no connection pin.
43	SCL/SCLK	Serial-Clock Input. SCL is the I ² C-compatible clock input. SCLK is the SPI-compatible clock input.
44	SDA/DIN	Serial-Data Input/Output. SDA is the I ² C-compatible input/output. DIN is the SPI-compatible data input.
45	A1/DOUT	Address-Select Input 1/Data Out. In I ² C mode, this is the address-select input 1. See Table 1. In SPI mode, this is the serial-data output. Data is clocked out on the falling edge of SCLK. DOUT is a high-impedance output when \overline{CS} is driven high.
46	BUSY	Busy Output. BUSY goes high to indicate activity.
—	EP	Exposed Pad. Connect EP to AGND. Internally connected to AGND.

Dual RF LDMOS Bias Controller with Nonvolatile Memory

Functional Diagram

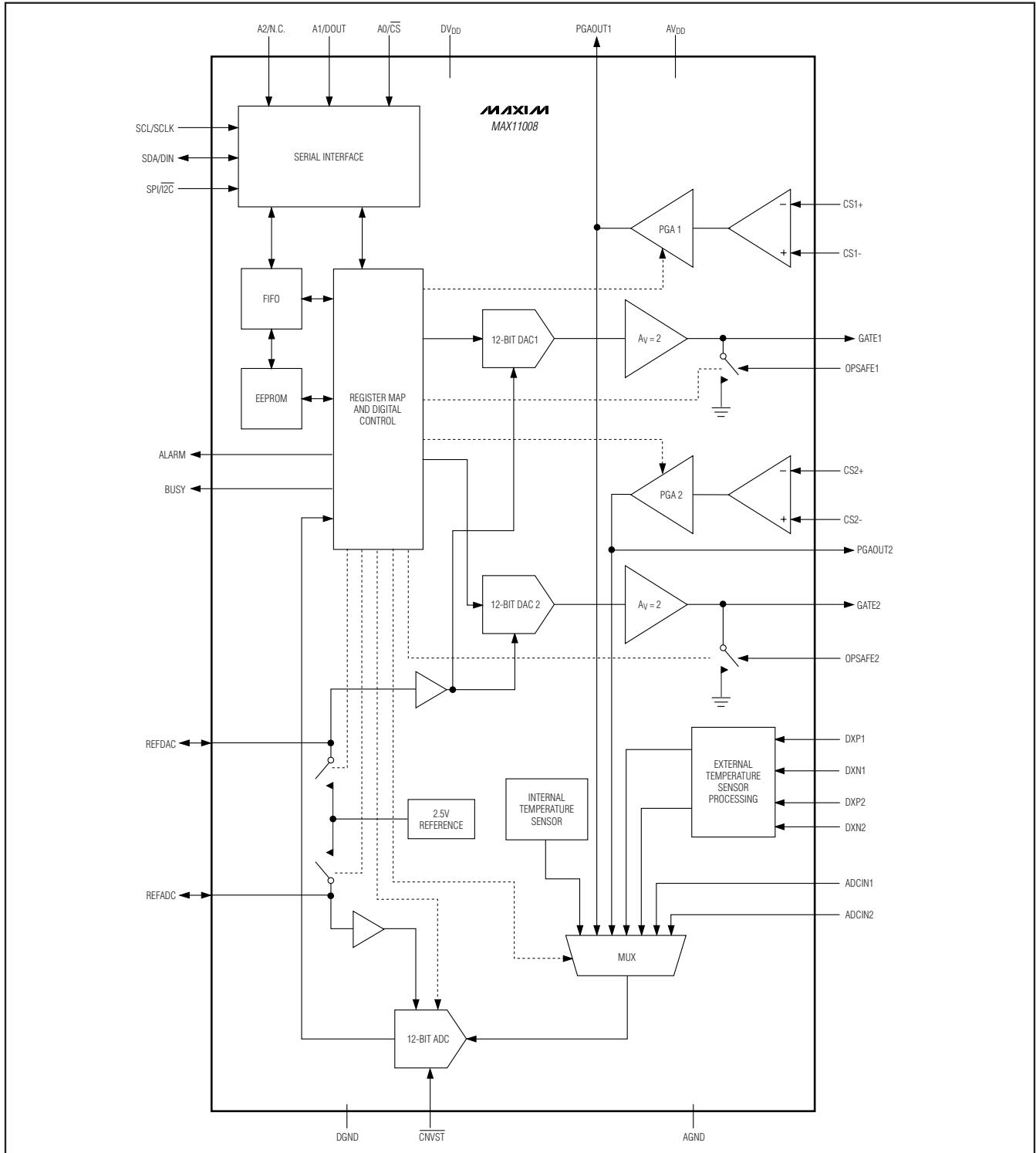

Dual RF LDMOS Bias Controller with Nonvolatile Memory

Typical Application Circuits—I²C Interface

MAX11008

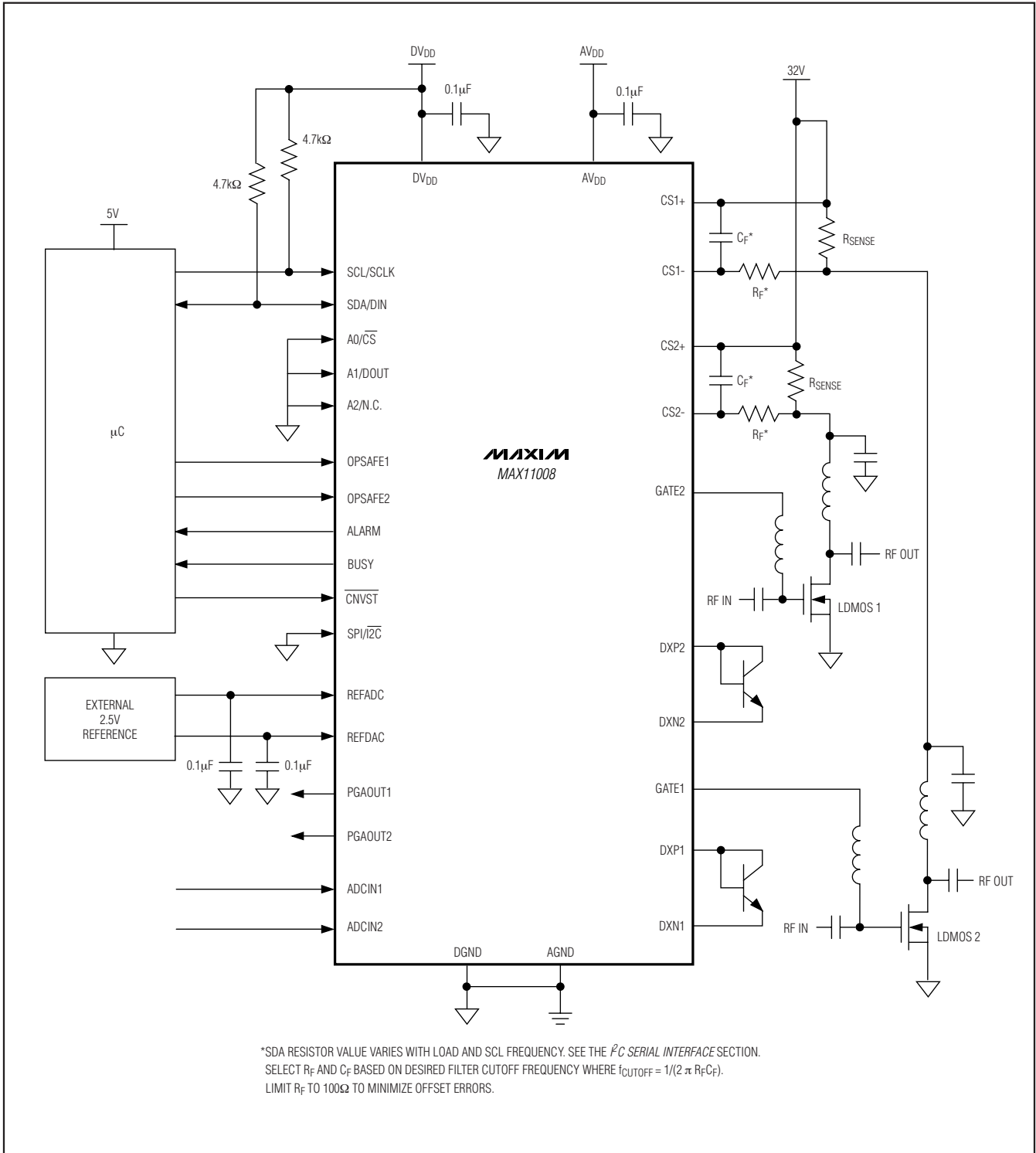

*SDA RESISTOR VALUE VARIES WITH LOAD AND SCL FREQUENCY. SEE THE I²C SERIAL INTERFACE SECTION.
 SELECT R_F AND C_F* BASED ON DESIRED FILTER CUTOFF FREQUENCY WHERE $f_{CUTOFF} = 1/(2\pi R_F C_F)$.
 LIMIT R_F TO 100Ω TO MINIMIZE OFFSET ERRORS.

Dual RF LDMOS Bias Controller with Nonvolatile Memory

Typical Application Circuits—SPI Interface

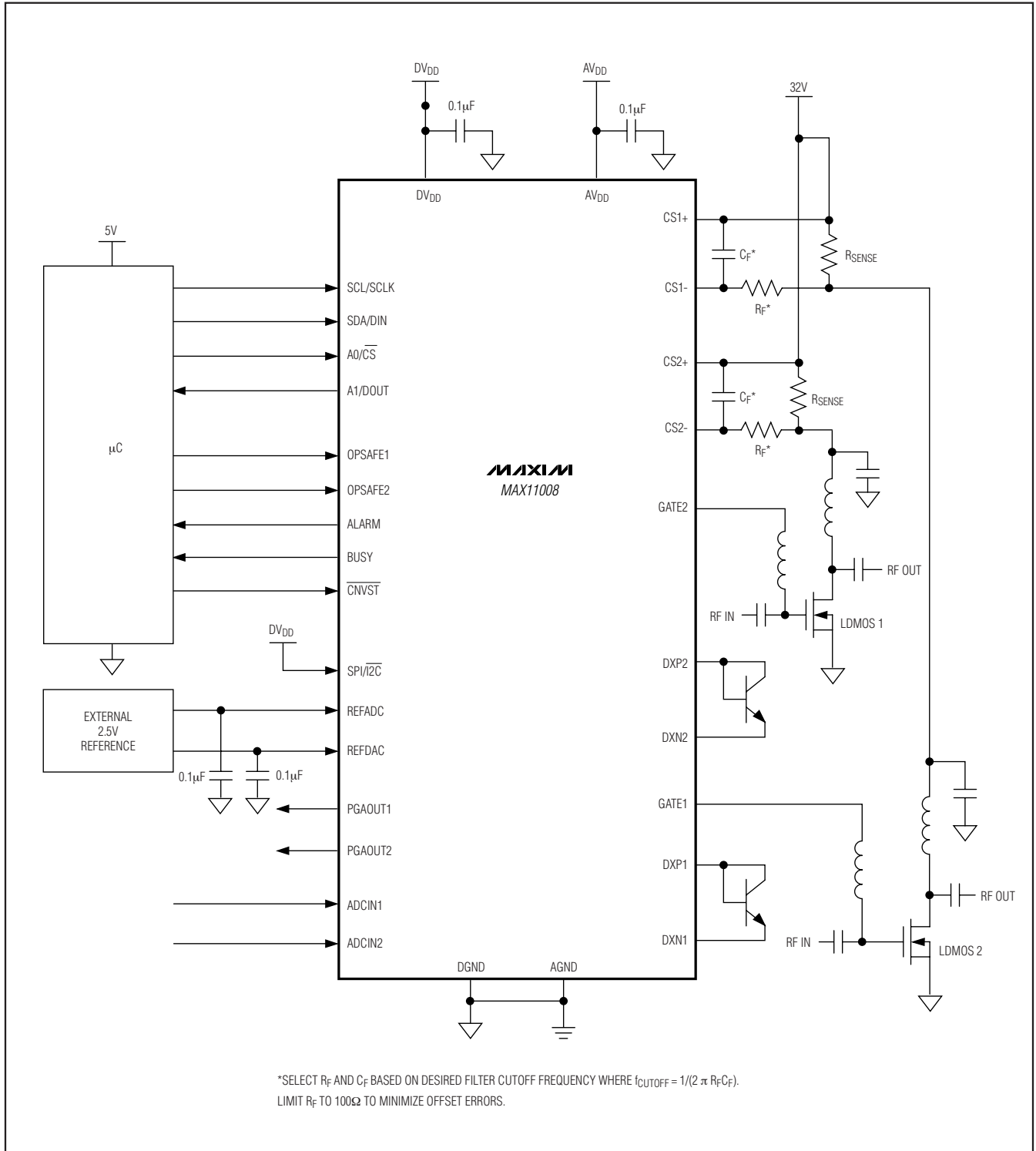

Dual RF LDMOS Bias Controller with Nonvolatile Memory

Detailed Description

The MAX11008 sets and controls the bias conditions for dual RF LDMOS power devices found in cellular base-station power amps. Each device includes two high-side current-sense amplifiers with programmable gains of 2, 10, and 25 to monitor the LDMOS transistor drain current over the 20mA to 5A range. Two external diode-connected transistors monitor the LDMOS transistor temperatures while an internal temperature sensor measures the local die temperature of the MAX11008. The 12-bit ADC is interfaced to a 7:1 multiplexer and converts the signals from the PGA outputs, internal and external temperature readings, or the two auxiliary analog inputs into digital data results that can be stored in the FIFO.

On the control side, two gate-drive channels, driven from two 12-bit DACs and a gain stage of 2, generate a positive gate voltage bias for the LDMOS. Each gate-drive output supports up to $\pm 2\text{mA}$ of gate current. The gate-drive amplifier is current-limited to $\pm 25\text{mA}$ and features a fast clamp to analog ground that operates independently of the serial interface.

The MAX11008 includes an on-chip, nonvolatile EEPROM that stores LUTs and register information. The LUTs are designed to store gate voltage vs. temperature curves for the LDMOS FET. The data is used for temperature compensation of the LDMOS FET's bias point. The LUTs can also contain compensation data for another independent parameter: either sense voltage or AIN voltage.

Digital Serial Interface

The MAX11008 features both an I²C and an SPI-compatible serial interface. Connect SPI/ $\overline{\text{I}^2\text{C}}$ to DGND to select the I²C serial-interface operation, or to DV_{DD} to select the SPI serial-interface operation. Do not alter interface mode during operation.

SPI Serial Interface

Connect SPI/ $\overline{\text{I}^2\text{C}}$ to DV_{DD} to select the SPI interface. The SPI serial interface consists of a serial data input (DIN), a serial clock line (SCLK), a chip select ($\overline{\text{CS}}$), and a serial data output (DOUT). The use of serial data output (DOUT) is optional and is only required when data is to be read back by the master device. The MAX11008 is SPI compatible within the range of V_{DD} = +2.7V to +5.25V. DIN, SCLK, $\overline{\text{CS}}$, and DOUT facilitate bidirectional communication between the MAX11008 and the master at rates up to 20MHz.

Figure 1 illustrates the 4-wire interface timing diagram. The MAX11008 is a transmit/receive slave-only device, relying upon a master to generate a clock signal. The master initiates data transfer on the bus and generates the SCLK signal to permit data transfer.

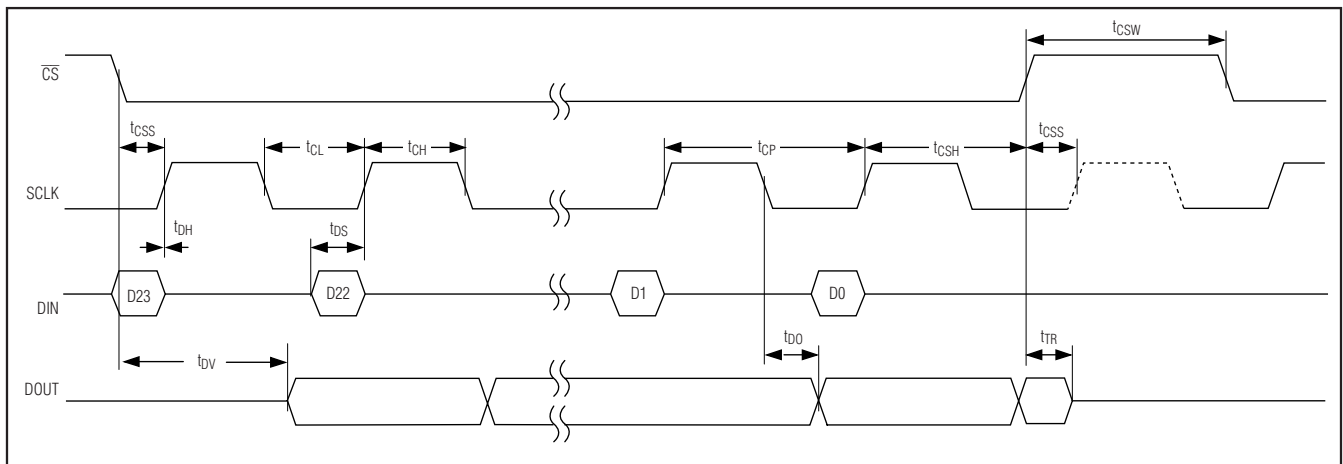

Figure 1. SPI Serial-Interface Timing

Dual RF LDMOS Bias Controller with Nonvolatile Memory

The SPI bus cycles are 24 bits long. Data can be supplied as three 8-bit bytes or as a continuous 24-bit stream. \overline{CS} must remain low throughout the 24-bit sequence. The first 8-bit byte is a command byte C[7:0]. The next 16 bits are data bits D[15:0]. Clock signal SCLK can idle low or high, but data is always clocked in on the rising edge of SCLK (CPOL = CPHA).

SPI data transfers begin with the falling edge of \overline{CS} . Data is clocked into the device on the rising edges of SCLK and clocked out of the device on the falling edges of SCLK. For correct bus cycles, \overline{CS} should frame the data and should not return to a 1 until after the last active rising clock edge. See Figure 2 for timing details. A rising edge of \overline{CS} causes DOUT to three-state and data reads should be performed accordingly. See Figures 1 and 3.

When writing instructions to the MAX11008, 24 clock cycles must be completed before \overline{CS} is driven high. The MAX11008 executes the instruction only after the 24th clock cycle has been received and \overline{CS} is driven high. To abort unwanted instructions, \overline{CS} can be driven high at any time before the 23rd rising clock edge.

When reading data from the MAX11008, 24 clock cycles must be completed before \overline{CS} is driven high. If \overline{CS} is driven high before the completion of the 24th falling edge, DOUT immediately three-states, the interface resets in preparation for the next command, and the data being read is lost.

Write Format

Use the following sequence to write 16 bits of data to a MAX11008 register (see Figure 2):

- 1) Drive \overline{CS} low to select the device.
- 2) Send the appropriate write command byte (see Table 6 for the register address map). The command byte is clocked in on the rising edge of SCLK.
- 3) Send 16 bits of data D[15:0] starting with the most significant bit (MSB). Data is clocked in on the rising edges of SCLK.
- 4) Drive \overline{CS} high to conclude the command.

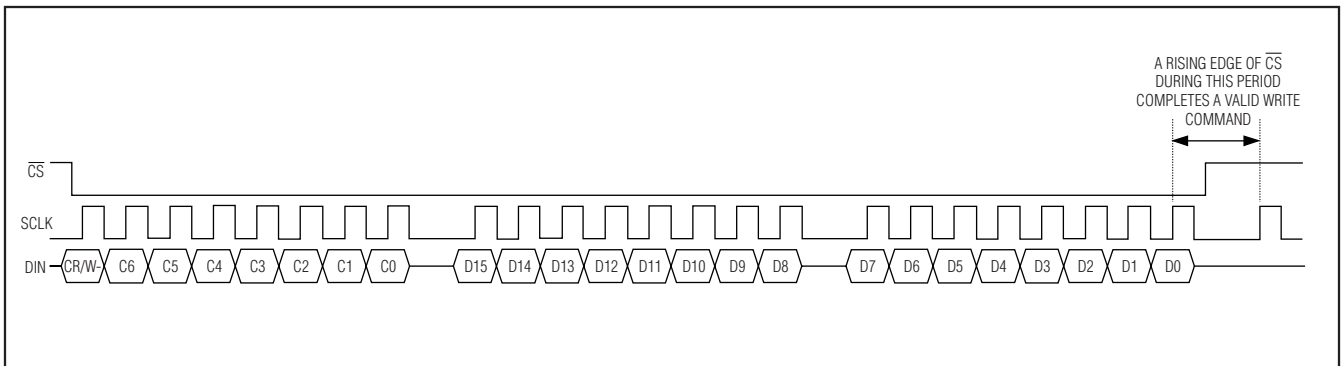

Figure 2. SPI Write Sequence

Dual RF LDMOS Bias Controller with Nonvolatile Memory

Read Format

Use the following sequence to read 16 bits of data from a MAX11008 register (see Figure 3):

- 1) Drive \overline{CS} low to select the device.
- 2) Send the appropriate read command byte (see Table 6 for the register address map). The command byte is clocked in on the rising edges of SCLK.
- 3) Receive 16 bits of data. The first 4 bits of data are always high. Data is clocked out on the falling edges of SCLK.
- 4) Drive \overline{CS} high.

I²C Serial Interface

Connect SPI/ \overline{I}^2C to DGND to select the I²C interface. The I²C serial interface consists of a serial data line (SDA) and a serial clock line (SCL). The MAX11008 is I²C compatible within the DV_{DD} = 2.7V to 5.25V range. SDA and SCL facilitate bidirectional communication between the MAX11008 and the master at rates up to 400kHz for fast mode and up to 3.4MHz for high-speed mode (HS mode). See the *Bus Timing* and *HS I²C Mode* sections for more information on data-rate configurations.

Figure 4 shows the 2-wire interface timing diagram. The MAX11008 is a transmit/receive slave-only device, relying upon a master to generate a clock signal. The master (typically a microcontroller) initiates data transfers on the bus and generates the SCL signal to permit data transfer.

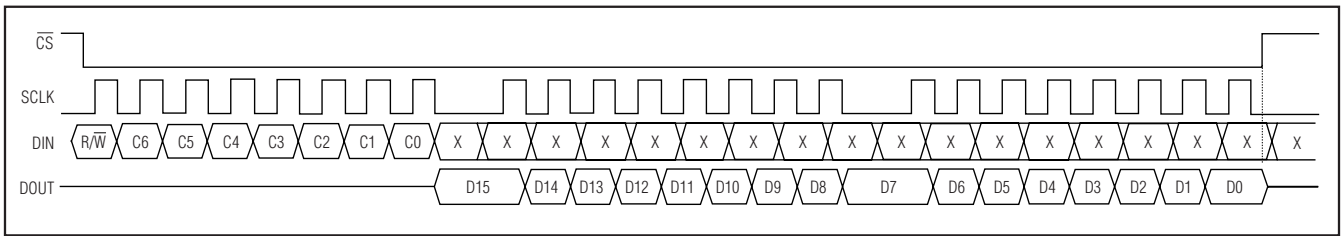

Figure 3. SPI Read Sequence

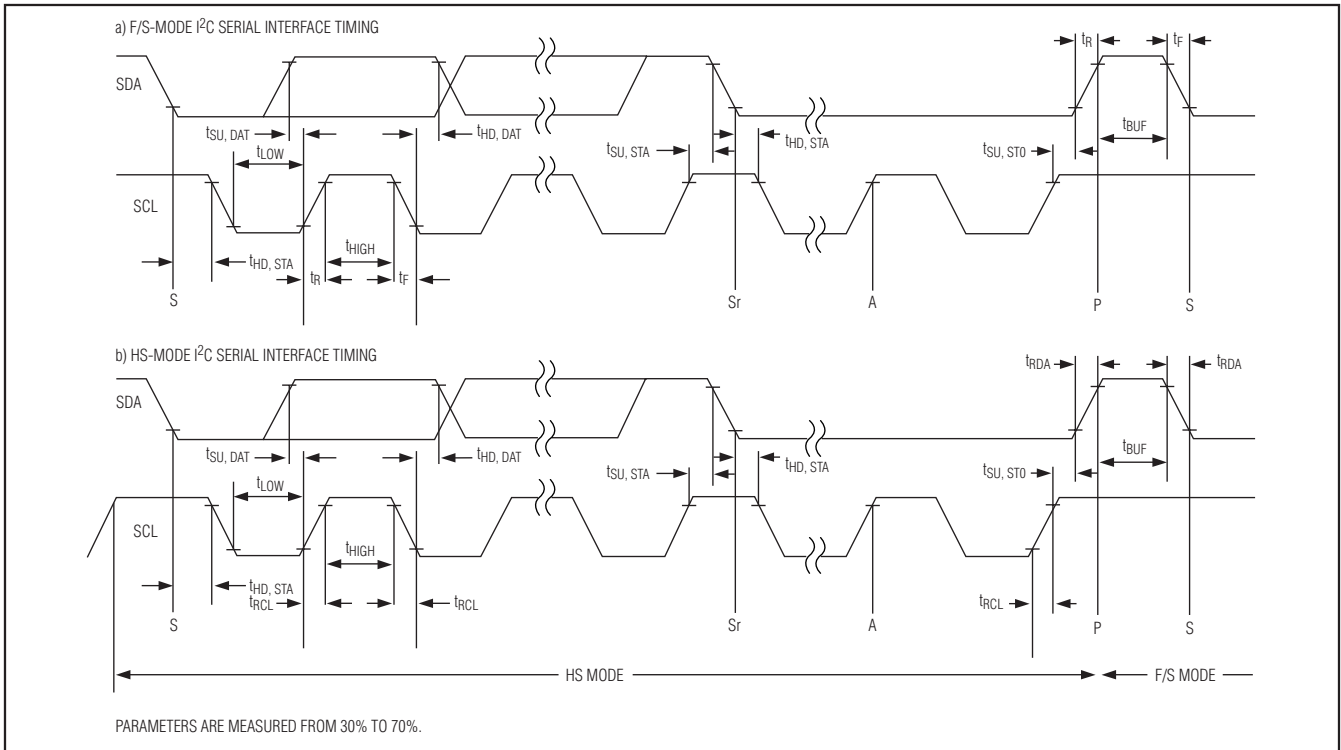

Figure 4. I²C Serial-Interface Timing Diagram

Dual RF LDMOS Bias Controller with Nonvolatile Memory

A master device communicates to the MAX11008 by transmitting the proper slave address followed by a command and/or data words. Each transmit sequence is framed by a START (S) or repeated START (Sr) condition and a STOP (P) condition. Each word transmitted over the bus is 8 bits long and is always followed by an acknowledge clock pulse.

The MAX11008 SDA and SCL drivers are open-drain outputs, requiring a pullup resistor (750Ω or greater) to generate a logic-high voltage (see the *Typical Application Circuits*). Series resistors are optional for noise filtering. These series resistors protect the input stages of the MAX11008 from high-voltage spikes on the bus line, and minimize crosstalk and undershoot of the bus signals.

Bit Transfer

One data bit is transferred during each SCL clock cycle. The data on SDA must remain stable during the high period of the SCL clock pulse. Changes in SDA while SCL is high are control signals (see the *START and STOP Conditions* section). Both SDA and SCL idle high when the I²C bus is not busy.

START and STOP Conditions

The master initiates a transmission with a START condition (S), which is a high-to-low transition on SDA while

SCL is high. The master terminates a transmission with a STOP condition (P), which is a low-to-high transition on SDA while SCL is high (see Figure 5). A repeated START condition (Sr) can be used in place of a STOP condition to leave the bus active and the mode unchanged (see the *HS I²C Mode* section).

Acknowledge Bits and Not-Acknowledge Conditions

Data transfers are framed with an acknowledge bit (ACK) or a not-acknowledge bit (NACK). Both the master and the MAX11008 (slave) generate acknowledge bits. To generate an acknowledge, the receiving device must pull SDA low before the rising edge of the acknowledge-related clock pulse (ninth clock pulse) and keep it low during the high period of the clock pulse (see Figure 6).

To generate a not-acknowledge condition, the receiver allows SDA to be pulled high before the rising edge of the acknowledge-related clock pulse, and leaves SDA high during the high period of the clock pulse. Monitoring the acknowledge bits allows for detection of unsuccessful data transfers. An unsuccessful data transfer happens if a receiving device is busy or if a system fault has occurred. In the event of an unsuccessful data transfer, the bus master reattempts communication at a later time.

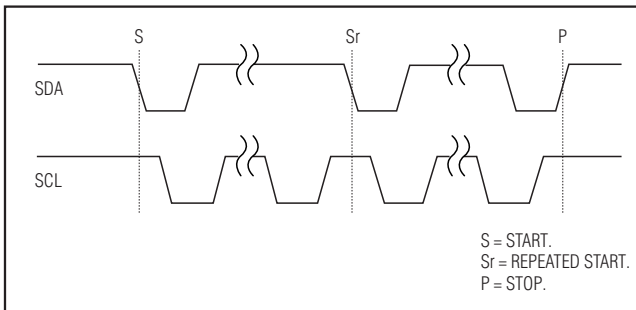

Figure 5. START and STOP Conditions

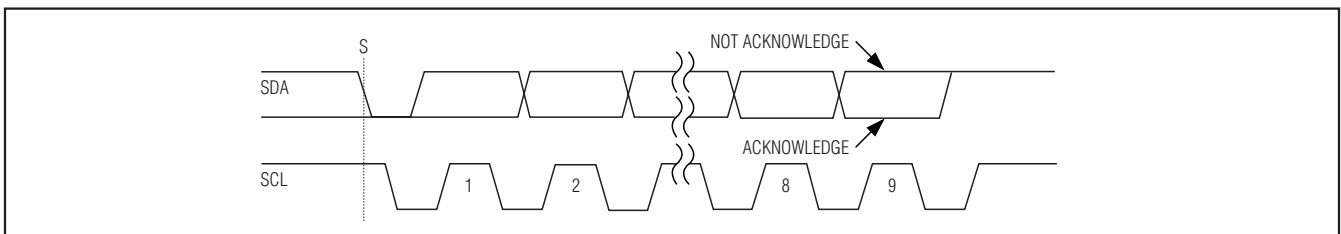

Figure 6. Acknowledge Bits

Dual RF LDMOS Bias Controller with Nonvolatile Memory

Slave Address

A bus master initiates communication with a slave device by issuing a START condition followed by the 7-bit slave address and a read/write (R/W) bit (see Figure 7). When the device recognizes its slave address, it is ready to accept or send data depending on the R/W bit. When the MAX11008 recognizes its slave address, it issues an ACK by pulling SDA low for one clock cycle and is ready to accept or send data depending on the R/W bit that was sent.

The MAX11008 has eight user-selectable slave addresses, which are set through inputs A0, A1, and A2 (see Table 1). This feature allows up to eight MAX11008 devices to share the same bus inputs. The 4 MSBs D[7:4] are factory set, and the 3 LSBs are user-selectable.

Bus Timing

At power-up, the bus timing is set for I²C fast-mode (F/S mode), which allows I²C clock rates up to 400kHz. The MAX11008 can also operate in high-speed mode (HS mode) to achieve I²C clock rates up to 3.4MHz. See Figure 4 for I²C bus timing.

HS I²C Mode

Select HS mode by addressing all devices on the bus with the HS-mode master code 0000 1XXX (X = don't care). After successfully receiving the HS-mode master code, the MAX11008 issues a NACK, allowing SDA to be pulled high for one clock cycle (see Figure 8). After the NACK, the MAX11008 operates in HS mode. The master must then send a repeated START (Sr) followed by a slave address to initiate HS-mode communication. If the master generates a STOP condition, the

Table 1. Slave Address Select

A2	A1	A0	ADDRESS
0	0	0	0101000
0	0	1	0101001
0	1	0	0101010
0	1	1	0101011
1	0	0	0101100
1	0	1	0101101
1	1	0	0101110
1	1	1	0101111

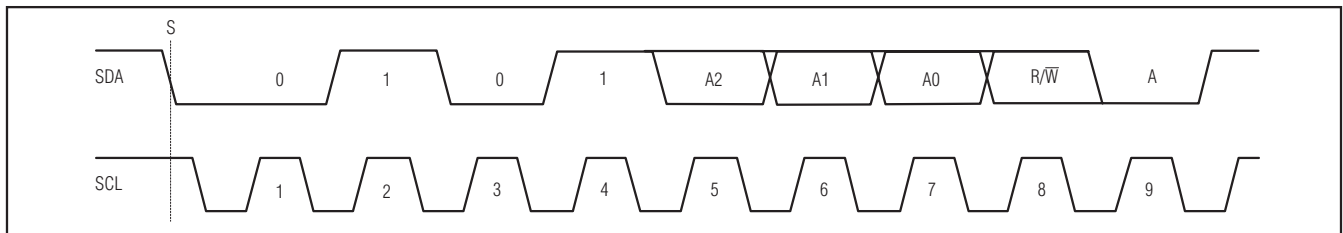

Figure 7. Slave Address Bits

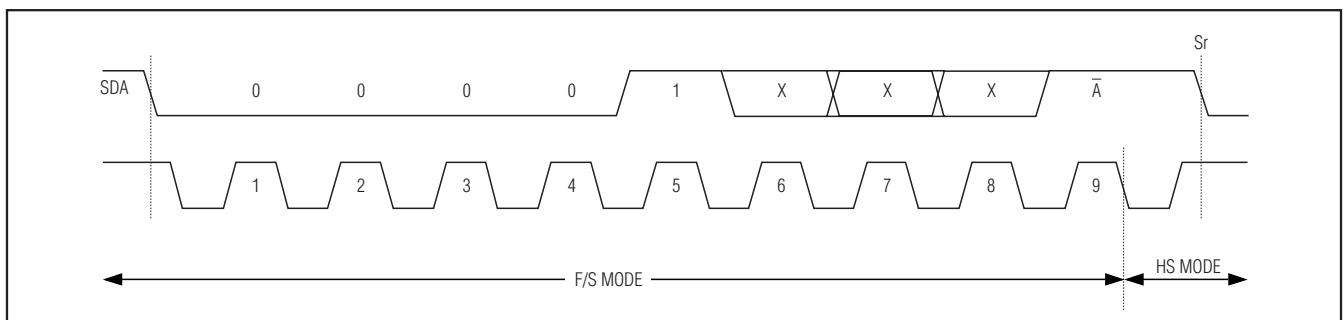

Figure 8. F/S-Mode to HS-Mode Transfer

Dual RF LDMOS Bias Controller with Nonvolatile Memory

MAX11008 returns to F/S mode. Use a repeated START condition in place of a STOP condition to leave the bus active and the mode unchanged. Figure 9 summarizes the data bit transfer format for HS-mode communication.

Register Address/Data Bytes (Write Cycle)

A write cycle begins with the bus master issuing a START condition followed by 7 address bits (see Figure 5 and Table 1) and a write bit ($R/\bar{W} = 0$). Once the slave address is recognized and the write bit is received, the MAX11008 (I²C slave) issues an ACK by pulling SDA low for one clock cycle. The master then sends the register address byte (command byte) to the

slave. The MSB of the register address byte is the read/write bit for the destination register address of the slave and must be set to 0 for a write cycle (see the *Register Address Map* section). After receiving the byte, the slave issues another acknowledge, pulling SDA low for one clock cycle. The master then writes two data bytes, receiving an ACK from the slave after each byte is sent. The master ends the write cycle by issuing a STOP condition. When operating in HS mode, a STOP condition returns the bus into F/S mode (see the *HS I²C Mode* section). Figure 10 shows a complete write cycle.

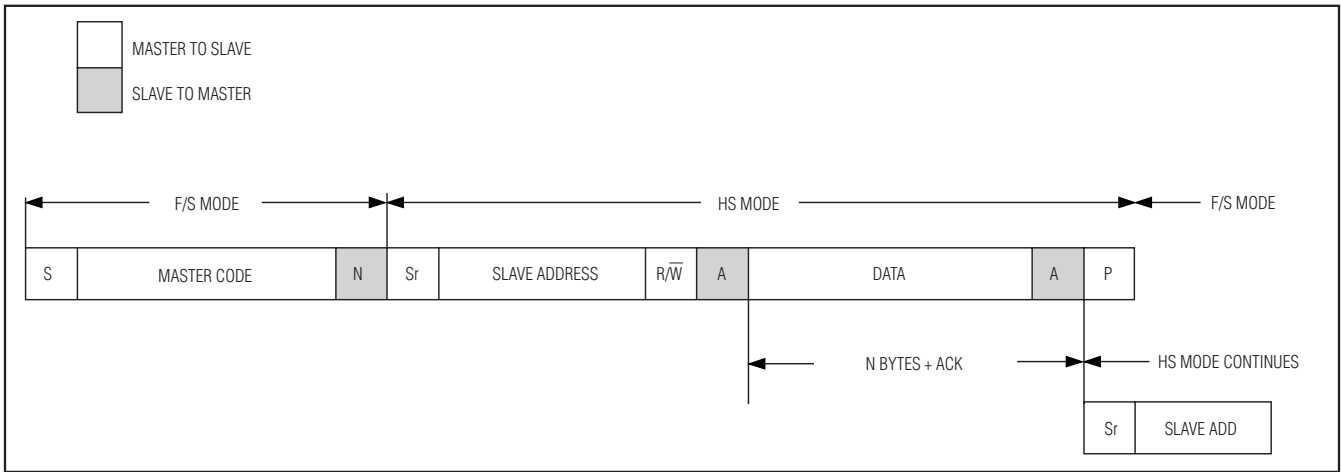

Figure 9. Data-Transfer Format in HS Mode

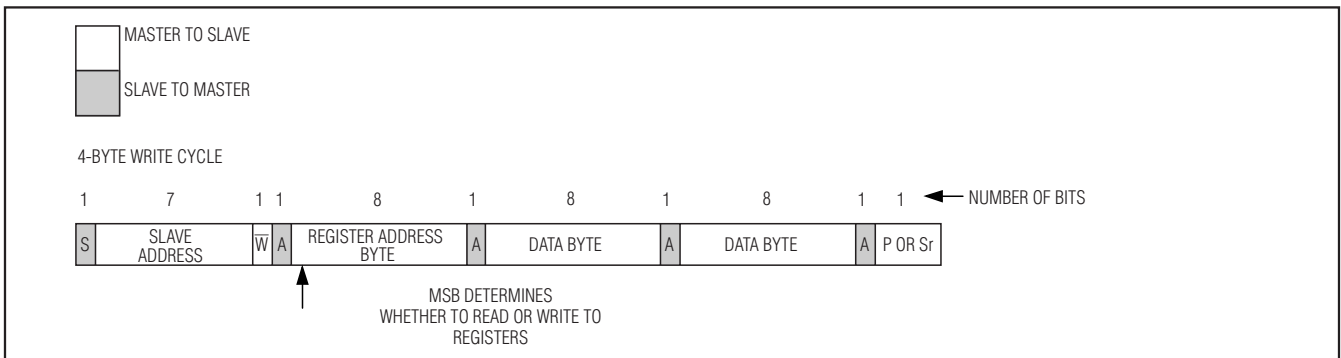

Figure 10. Write Cycle

Dual RF LDMOS Bias Controller with Nonvolatile Memory

Register Address/Data Bytes (5-Byte Read Cycle)

A read cycle begins with the master issuing a START condition followed by a 7-bit address, (see Figure 5 and Table 1) and a write bit ($R/\bar{W} = 0$) to instruct the MAX11008 interface that it is about to receive data. Once the slave address is recognized and the write bit is received, the MAX11008 (I²C slave) issues an ACK by pulling SDA low for one clock cycle. The master then sends the register address byte (command byte) to the slave. The MSB of the register address byte is the read/write bit for the destination register address of the slave and must be set to 1 for a read cycle (see the *Register Address Map* section). After this byte is received, another acknowledge bit is sent to the master from the slave. The master then issues a repeated START (Sr) condition. Following a repeated START (Sr), the master writes the slave address byte again with a read bit ($R/\bar{W} = 1$). After a third acknowledge signal from the slave, the data direction on the SDA bus reverses and the slave writes the 2 data bytes (the

contents of the register that was addressed in the previous command byte) to the master. Finally, the master issues a NACK followed by a STOP condition (P), ending the read cycle. Figure 11 shows a complete 5-byte read cycle.

Default Read Cycle (3-Byte Read Cycle)

The MAX11008 2-wire interface has a unique feature for read commands. To avoid the necessity of sending 2 slave address bytes in one read cycle (see the 5-byte read cycle in Figure 11), the MAX11008 2-wire interface recognizes a single slave address byte with a read bit ($R/\bar{W} = 1$). In this case, the interface outputs the contents of the last read device register. This default read feature is useful when the master must perform multiple consecutive reads from the same device register. Figure 11 shows a complete 3-byte read cycle.

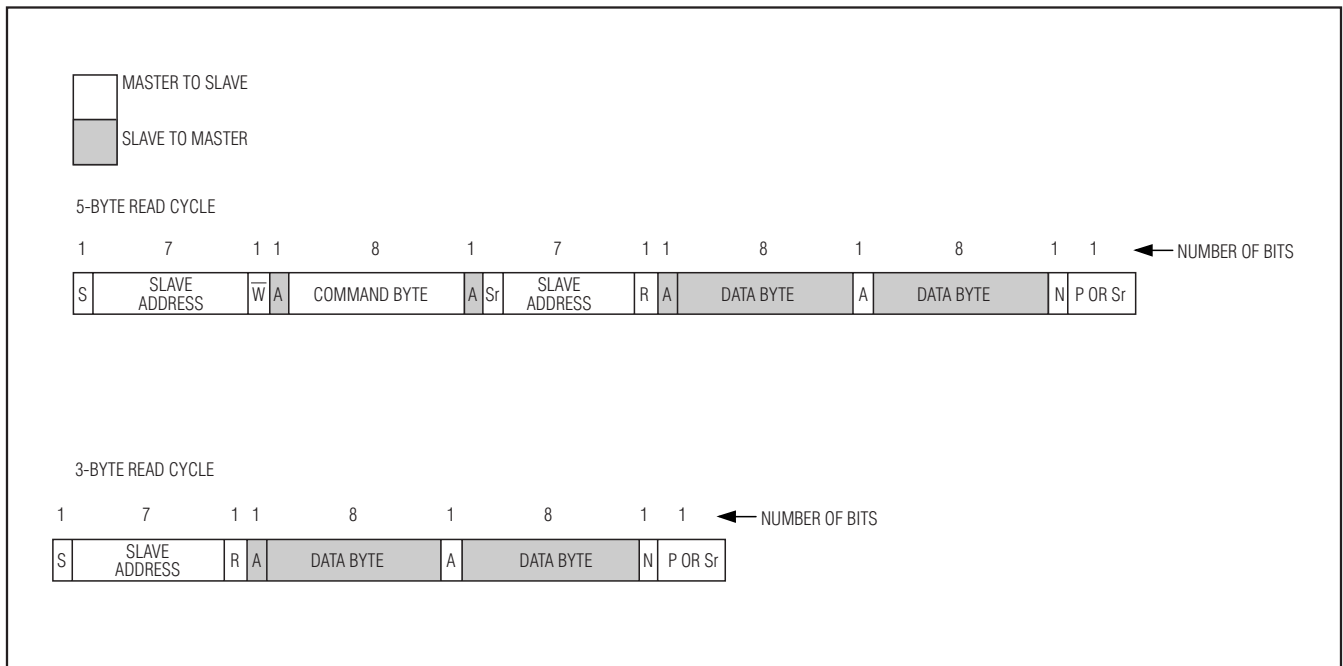

Figure 11. 5-Byte and 3-Byte Read Cycle

Dual RF LDMOS Bias Controller with Nonvolatile Memory

12-Bit ADC

The MAX11008 12-bit ADC uses a SAR conversion technique and on-chip track-and-hold (T/H) circuitry to convert the PGA outputs (PGAOUT1 and PGAOUT2), temperature measurements, and single-ended auxiliary input voltages (ADCIN1 and ADCIN2) into 12-bit digital data when in ADC monitor mode (see the *Hardware Configuration Register (HCFG) (Read/Write)* section). All nontemperature measurements are converted using a unipolar transfer function (see Figure 13), and all temperature measurements are converted using a bipolar transfer function (see Figure 14).

Analog Input T/H

Figure 12 shows the equivalent circuit for the ADC input architecture of the MAX11008. In track mode, an input capacitor is connected to the input signal (ADCIN1, ADCIN2, PGAOUT1, PGAOUT2, or temperature sensor processor output). Another input capacitor is connected to AGND. After the T/H enters hold mode, the difference between the sampled positive and negative input voltages is converted. The charging rate of the input capacitance determines the time required for the T/H to acquire an input signal. If the input signal's source impedance is high, the required acquisition time lengthens accordingly.

Any source impedance below 300Ω does not affect the ADC's AC performance. A high-impedance source can be accommodated either by lengthening t_{ACQ} or by placing a $1\mu\text{F}$ capacitor between the positive and negative analog inputs. The combination of the analog-input source impedance and the capacitance at the analog input creates an RC filter that limits the analog input bandwidth.

Input Bandwidth

The ADC's input-tracking circuitry has a 1MHz small-signal bandwidth, to digitize high-speed transient events and measure periodic signals with bandwidths exceeding the ADC's sampling rate by using under-sampling techniques. Anti-alias filtering of the input signals is necessary to prevent high-frequency components from aliasing into the frequency band of interest.

Analog Input Protection

Internal electrostatic-discharge (ESD) protection diodes clamp all analog inputs to AV_{DD} and AGND, allowing the inputs to swing from $(\text{AGND} - 0.3\text{V})$ to $(\text{AV}_{\text{DD}} + 0.3\text{V})$ without damage. However, for accurate conversions near full scale, the inputs must not exceed AV_{DD} by more than 50mV or be lower than AGND by 50mV. If an analog input voltage exceeds the supplies, limit the input current to 2mA.

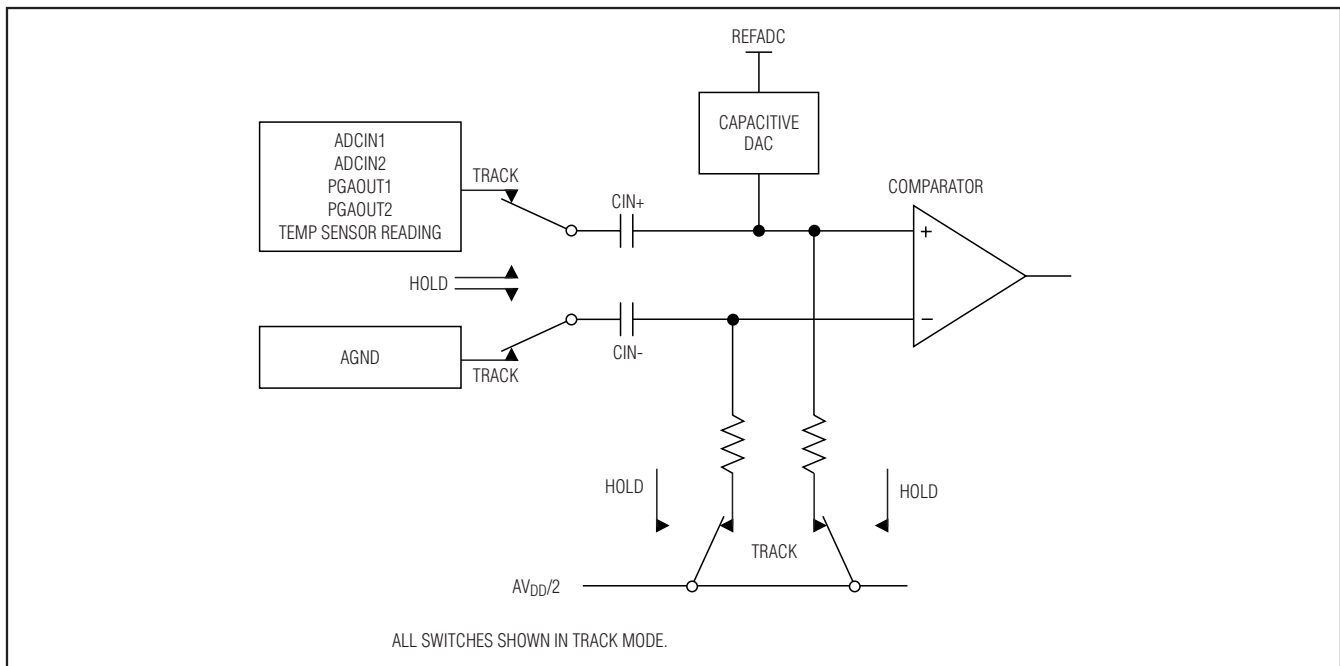

Figure 12. Analog Input Track and Hold

Dual RF LDMOS Bias Controller with Nonvolatile Memory

ADC Transfer Functions

Figure 13 shows the unipolar transfer function for non-temperature measurements, and Figure 14 shows the bipolar transfer function used for temperature measurements. Code transitions occur halfway between successive-integer LSB values. Output coding is binary, with $1 \text{ LSB} = V_{\text{REFADC}}/4096$ for nontemperature measurements, and $1 \text{ LSB} = +0.125^\circ\text{C}$ for temperature measurements. All signed binary results use two's complement format.

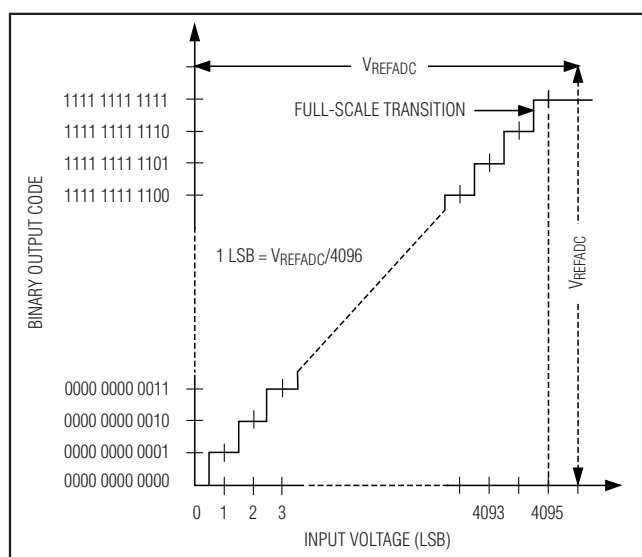

Figure 13. ADC Transfer Function

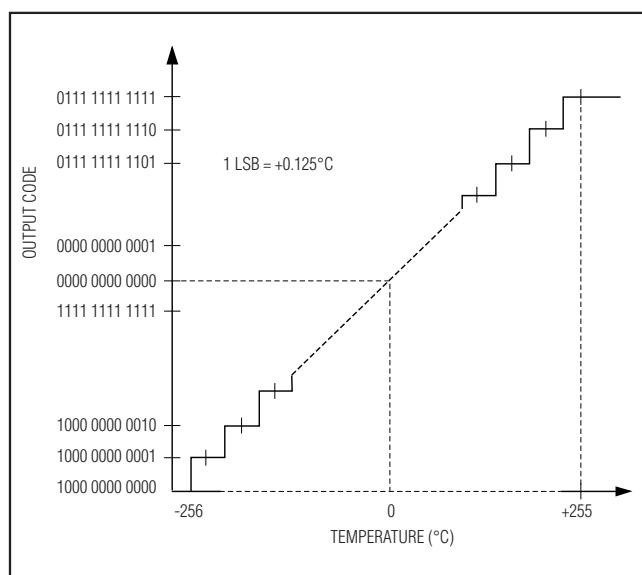

Figure 14. Temperature Transfer Function

ADC Conversion Scheduling

The MAX11008 ADC multiplexer scans and converts the selected inputs in the order shown in Table 2 (see the *ADC Conversion Register (ADCCON) (Write Only)* section) when more than one channel is selected. The results are stored in the FIFO when in ADC monitoring mode. The BUSY signal is set at the start and reset at the end of a scan except when the continuous convert bit is set at which time BUSY does not then respond to ADC conversions.

Writing a conversion command before a conversion is complete cancels the pending conversion. Avoid addressing the device using the serial interface while the ADC is converting.

Table 2. Order of ADC Conversion Scan

ORDER OF SCAN	DESCRIPTION OF CONVERSION
1	Internal device temperature
2	External diode 1 temperature
3	Output of PGA 1 for current sense
4	Auxiliary input 1 (ADCIN1)
5	External diode 2 temperature
6	Output of PGA 2 for current sense
7	Auxiliary input 2 (ADCIN2)

ADC Clock Modes

The MAX11008 offers three conversion/acquisition modes (known as clock modes) selectable through configuration register bits CKSEL1 and CKSEL0.

If the ADC conversion requires the internal reference (temperature measurement or voltage measurement with internal reference selected) and the reference has not been previously forced on ($\text{FBGON} = 1$), the device inserts a typical delay of $72\mu\text{s}$, for the reference to settle, before commencing the ADC conversion. The reference remains powered up while there are pending conversions. If the reference is not forced on, it automatically powers down at the end of a scan or when CONCONV in the ADC Conversion register is set back to 0.

Internally Timed Acquisitions and Conversions

Clock Mode 00

In clock mode 00, power-up, acquisition, conversion, and power-down are all initiated by writing to the ADC Conversion register and performed automatically using the internal oscillator. This is the default clock mode. The ADC sets the BUSY output high, powers up, and scans all requested channels storing the results in the FIFO if the ADCMON bit has been set. After the scan is

Dual RF LDMOS Bias Controller with Nonvolatile Memory

complete the ADC powers down, BUSY is pulled low, and the results for all of the selected channels are available in the FIFO.

The duration of the BUSY pulse is additive, depending on the channel conversion sequence selected. The BUSY pulse is set typically for 72µs by temperature conversions; 52µs by PGAOUT conversions, and 7µs by ADCIN conversions.

Clock Mode 01

In clock mode 01, power-up, acquisition, conversion, and power-down are all initiated through a single pulse on $\overline{\text{CNVST}}$ and performed automatically using the internal oscillator. Initiate a scan by writing to the ADC conversion register and setting $\overline{\text{CNVST}}$ low for at least 20ns. The ADC sets the BUSY output high, powers up, and scans all requested channels storing the results in the FIFO if the ADCMON bit has been set. After the scan is complete, the ADC powers down, BUSY is pulled low, and the results for all of the selected channels are available in the FIFO. The BUSY pulse behavior is identical to that of clock mode 00.

Externally Timed Acquisitions and Conversions

Clock Mode 10

Clock mode 10 is reserved. Do not use this clock mode.

Clock Mode 11

In clock mode 11, set the FBGON bit. Conversions are initiated one at a time through $\overline{\text{CNVST}}$ and performed using the internal oscillator. In this mode, the acquisition time is controlled by the time $\overline{\text{CNVST}}$ is low. $\overline{\text{CNVST}}$ is resynchronized by the internal oscillator, resulting in a one-clock cycle (typically 320ns) uncertainty in the exact sampling instant. Different timing parameters apply depending if the conversion is temperature, from ADCIN, or from PGAOUT (as specified in the *Clock Mode 00* section). Figure 15 shows a conversion time example.

Both internal and external temperature conversions are internally timed. Pull $\overline{\text{CNVST}}$ low for a minimum of 20ns (t_{CNV11}) to trigger a temperature conversion. The BUSY output goes high and the temperature conversion result is available in the FIFO (if the ADCMON bit is set) 72µs (typ) after BUSY goes low again.

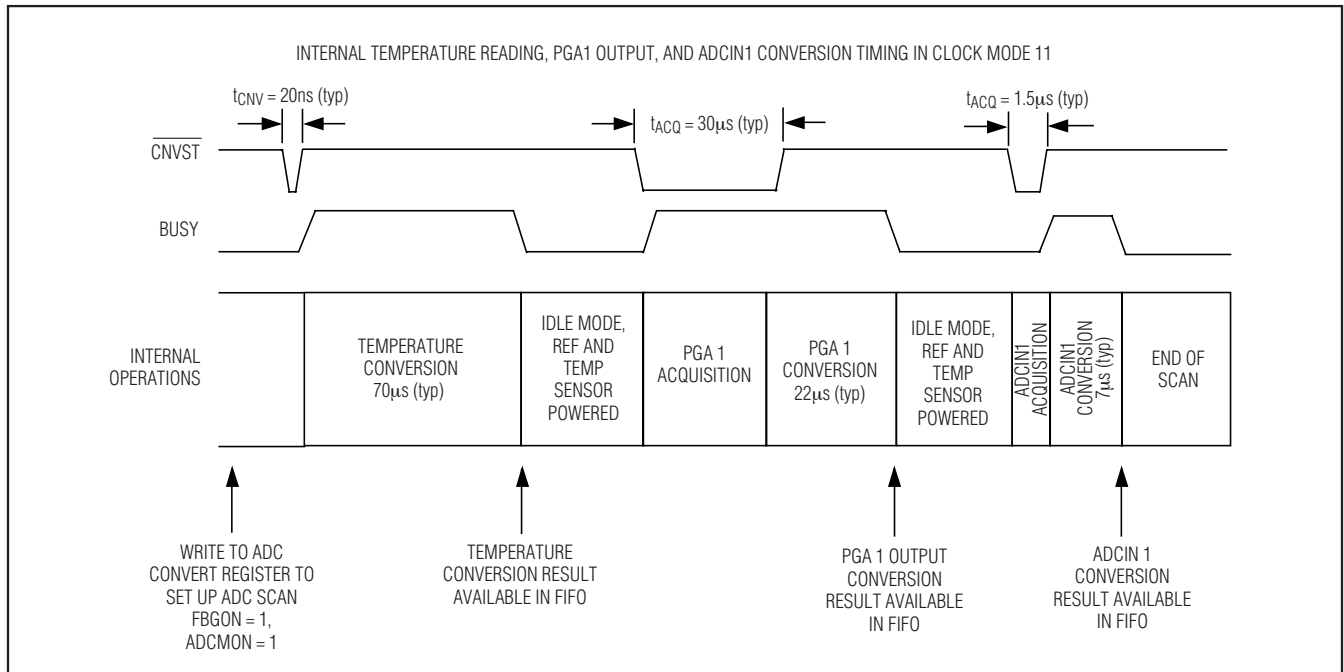

Figure 15. ADC Clock Mode 11 Example

Dual RF LDMOS Bias Controller with Nonvolatile Memory

For a PGAOUT conversion, set $\overline{\text{CNVST}}$ low for a minimum of 30 μs or maximum of 40 μs . The BUSY output goes high at the start of the $\overline{\text{CNVST}}$ pulse and the PGAOUT conversion result is available in the FIFO (if the ADCMON bit has been set) 52 μs (typ) after BUSY goes low again.

For an ADCIN conversion, set $\overline{\text{CNVST}}$ low for at least 1.5 μs . The BUSY output goes high at the end of the $\overline{\text{CNVST}}$ pulse and the ADCIN conversion result is available in the FIFO (if the ADCMON bit is set) 7 μs (typ) after BUSY goes low again.

For ease of operation, all $\overline{\text{CNVST}}$ pulses can use a 30 μs width irrespective of the source being converted. In the case of ADC conversions, the BUSY pulse width is extended accordingly. For clock modes 00 and 01, the BUSY pulse width duration depends on the channel conversion sequence selected.

Continuous conversion is not supported in this clock mode (see Table 20 for the ADC Conversion register).

Changing Clock Modes During ADC Conversions

If a change is made to the clock mode in the configuration register while the ADC is already performing a conversion (or series of conversions), the following describes how the MAX11008 responds:

- When CKSEL = 00 and is then changed to another value, the ADC completes the already triggered series of conversions and then goes idle. The BUSY output remains high until the conversions are completed. The MAX11008 then responds in accordance with the new CKSEL mode.
- When CKSEL = 01 and is then changed to another value and if the device is waiting for the initial external trigger, the MAX11008 immediately exits clock mode 01, powers down the ADC, and goes idle. The BUSY output stays low and the new clock mode is observed. If a conversion sequence has started, the ADC completes the requested conversions and then goes idle. The BUSY output remains high until the conversions are completed. The MAX11008 then responds in accordance with the new CKSEL mode.
- When CKSEL = 11 and is then changed to another value and if the device is waiting for an external trigger, the MAX11008 immediately exits clock mode 11,

powers down the ADC, and goes idle. The BUSY output stays low and the new clock mode is observed.

Turning the Continuous Conversion Bit (CONCONV) On and Off

When switching between continuous and single conversion modes, the clock mode requires resetting to avoid hanging the ADC sequencing routine.

For example, the following is the command sequence to switch from continuous to single conversion and revert to continuous conversion:

- 1) Write ADCCON (00000000 10110111).
- 2) Turn off the selected channels, but leave the continuous convert bit asserted. Write ADCCON (00000000 10000000).
- 3) Turn off the continuous convert bit. Write ADCCON (00000000 00000000).
- 4) Change from the current clock mode (00 in this case) to any other one. Write HCFIG (00000100 00011000).
- 5) Change the clock mode back. Write HCFIG (00000100 00001000).
- 6) Clear the FIFO. Write SCLR (00000000 00000100).
- 7) Perform the single conversion. Write ADCCON (00000000 00110111).
- 8) Read the FIFO five times to capture the results of the single conversions. Read FIFO.
- 9) Turn continuous convert back on. Write ADCCON (00000000 10110111).

The alternative to this command sequence is to leave continuous conversion on and just read the FIFO. When using this method, decode the channel tag to determine which channel has been read.

12-Bit DACs

In addition to the 12-bit ADC, the MAX11008 also includes two voltage-output, 12-bit, monotonic DACs with typically less than ± 2 LSB integral nonlinearity error and less than ± 1 LSB differential nonlinearity error. Each DAC also has a 45ms settling time and ultra-low glitch energy (4nV·s). The 12-bit DAC codes are unipolar binary with 1 LSB = $V_{\text{REFDAC}}/4096$.

Dual RF LDMOS Bias Controller with Nonvolatile Memory

Figure 16 shows the functional diagram of the MAX11008 DACs. Each DAC includes an input and output register. The input registers hold the result of the most recent write operation, and the output registers hold the current output code for the respective DAC. Data written to a DAC input register is transferred to its output register by writing to the Load DAC register (see Table 22). Alternatively, write data directly to the output register using the DAC Input and Output Data register.

The analog output voltages of the DACs (before amplification by the gate-drive amplifiers) are calculated with the following equation:

$$V_{DAC} = \frac{V_{DACREF} \times CODE}{4096}$$

where V_{DACREF} is the value of the internal or external reference voltage and $CODE$ is the decimal value of the 12-bit code contained in the output register.

Gate-Drive Amplifiers

The gate-drive amplifiers are proportional to the analog outputs of the 12-bit DACs and provide the necessary gate voltage to drive the external LDMOS transistors. Both amplifiers have a fixed gain of 2V/V and are capable of sourcing or sinking up to 2mA of current. Output short-circuit protection prevents output currents from exceeding $\pm 25\text{mA}$.

The gate output is equal to the DAC output voltage amplified by 2.

$$V_{GATE_} = 2 \times V_{DAC}$$

See the *Software Configuration Registers* and *Temperature/APC LUT Configuration Registers* sections for information on how the gate voltages are controlled by temperature and APC samples.

Output Clamp

The MAX11008 features an output clamp mode that protects the external LDMOS transistors by connecting the gate-drive amplifier outputs ($GATE_$) to AGND. The clamp mode can be controlled by the $OPSAFE_$ digital inputs or by setting the appropriate $ALMCLMP[1:0]$ bits in the Alarm Hardware Configuration register (see Table 14). When using the $OPSAFE_$ digital inputs, pull $OPSAFE_high$ to enter clamp mode and pull $OPSAFE_low$ to exit clamp mode. The clamp can also be activated automatically from the alarm trip point setting registers; see the *Alarm Software Configuration Register (ALMSCFIG)* (Read/Write) section.

Self-Calibration

Calibrate channel 1 and channel 2 by writing to the PGA Calibration Control register. The MAX11008 functions after power-up without a calibration. Command a calibration after powering up the device by setting the $TRACK$ bit to 0 and the $DOCAL$ bit to 1 (see Table 19). Subsequently, set the $TRACK$, $DOCAL$, and $SELFTIME$ bits to 1 to enable automatic self-calibration (approximately every 13ms). This minimizes loss of performance over temperature and supply-voltage variation. Alternatively, run self-calibration manually to control the timing of the operation. Set the $TRACK$ and $DOCAL$ bits to 1 and the $SELFTIME$ bit to 0 to perform manually triggered self-calibration.

The self-calibration algorithm cancels offsets at the PGA-drive amplifier inputs in approximately $50\mu\text{V}$ increments to improve accuracy. The self-calibration routine can be commanded when the DACs are powered down, but the results will not be accurate. For best results, run the calibration after the DAC power-up time, t_{DPUEXT} . The ADC's operation is suspended during a self-calibration. The $BUSY$ output returning low indicates the end of the self-calibration routine. Wait until the end of the self-calibration routine before requesting an ADC conversion.

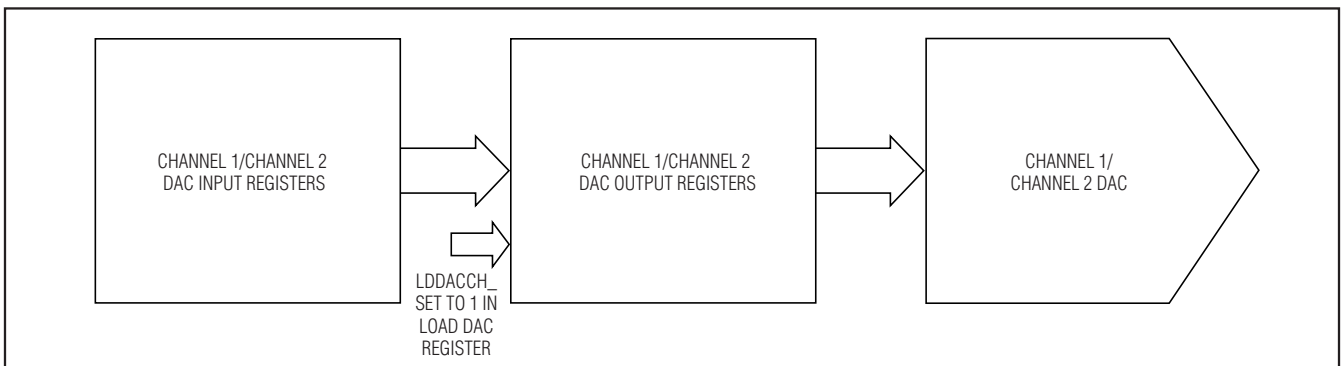

Figure 16. DAC Functional Diagram

Dual RF LDMOS Bias Controller with Nonvolatile Memory

ADC and DAC References

The MAX11008 provides an internal low-noise +2.5V reference for the ADCs, DACs and temperature sensor. When using the internal reference the REFDAC and REFADC inputs can either be left open or to improve noise performance, bypassed with a 0.1 μ F capacitor to AGND. Connect a voltage source to the REFADC input ranging between +1V to AV_{DD} to configure the device for external ADC reference mode. Connect a voltage source to the REFDAC input ranging between +0.7V to +2.5V to configure the device for external DAC reference mode. When using an external voltage reference, bypass the REFDAC and REFADC inputs with a 0.1 μ F capacitor to AGND. Bits D[3:0] within the Hardware Configuration register control the source of the DAC and ADC references. See Table 11.

Temperature Sensors

The MAX11008 measures the internal die temperature and two external LDMOS transistor temperatures through one internal and two external diode-connected transistors. The MAX11008 performs temperature measurements by changing the bias current of each diode from 4 μ A to 68 μ A to produce a temperature-dependent bias voltage difference. The internal ADC converts the voltage difference to a digital value. The conversion result at 4 μ A is subtracted from the conversion results at 68 μ A to calculate a digital value that is proportional to absolute temperature. The output data sent to the master will be the resultant digital code minus an offset value to adjust from Kelvin to Celsius. Temperature data is delivered to the master as a 12-bit signed (two's complement) fractional number with the 3 LSBs being the fractional bits. This provides a temperature measurement resolution of 1/8°C. See Table 3 for examples of the signed fractional number digital temperature codes.

Table 3. Signed Fractional Number Temperature-Code Examples

TEMPERATURE (°C)	DIGITAL CODE [D11:0]
-40	1110 1100 0000
-1.625	1111 1111 0011
0	0000 0000 0000
+27.125	0000 1101 1001
+105	0011 0100 1000

In clock mode 00, initiate temperature conversions by writing 0x13 to the ADC Conversion register. In clock mode 01, initiate temperature conversions by writing 0x13 to the ADC Conversion register and pulse $\overline{\text{CNVST}}$ low. In clock mode 11, initiate temperature conversions by writing 0x13 to the ADC Conversion register and pulse $\overline{\text{CNVST}}$ low for each channel conversion. Set the corresponding data bits for the temperature sensor to be measured to 1 (see the *ADC Conversion Register (ADCCON) (Write Only)* section and Table 20) for all three clock modes. Set the high and low external temperature thresholds through the temperature threshold registers. See the *Low Temperature Threshold Registers (TL1, TL2) (Read/Write)* section, *High Temperature Threshold Registers (TH1, TH2) (Read/Write)* section, and Tables 7 and 8).

The reference voltage for the temperature measurements is always derived from the internal reference source to ensure that 1 LSB corresponds to 1/8 of a degree Celsius. On every scan where only temperature measurements are requested, temperature conversions are carried out in the following order: INTEMP, EXTEMP1, then EXTEMP2. If the ADCMON bit is set when the conversions are performed, the temperature readings are available in the FIFO.

The temperature-sensing circuits power up at the start of an ADC conversion scan. The temperature-sensing circuits remain powered on until the end of the scan to avoid a 50 μ s delay caused by the internal reference power-up time required for each individual temperature channel. The temperature-sensor circuits remain powered up when the ADC conversion register's continuous convert bit (CONCONV, see Table 20) is set to 1 and the current ADC conversion includes a temperature channel. The temperature-sensor circuits remain powered up until the CONCONV bit is set low.

The external temperature-sensor drive current ratio has been optimized for a 2N3904 npn transistor with an ideality factor of 1.0065. The nonideality offset is removed internally by a preset digital coefficient. Using a transistor with a different ideality factor produces a proportionate difference in the absolute measured temperature. For more details on this topic and others related to using an external temperature sensor, refer to Application Note 1057: *Compensating for Ideality Factor and Series Resistance Differences between Thermal Sense Diodes* and Application Note 1944: *Temperature Monitoring Using the MAX1253/54 and MAX1153/54*.

Dual RF LDMOS Bias Controller with Nonvolatile Memory

High-Side Current-Sense Amplifiers and PGAs

The MAX11008 provides dual high-side current-sense and differential amplifier capability. The current-sense amplifiers provide a 5V to 32V input common-mode range. Both CS₊ and CS₋ must be within the specified common-mode range for proper operation of each amplifier.

The sense amplifiers measure the load current, I_{LOAD}, through an external sense resistor, R_{SENSE}, between the CS₊ and CS₋ inputs. The full-scale sense voltage range (V_{SENSE} = V_{CS+} - V_{CS-}) depends on the programmed gain (see the *Electrical Characteristics* section). The sense amplifiers provide a voltage output at PGAOUT1 and/or PGAOUT2, where the output voltage is determined by the following equation:

$$V_{PGAOUT_} = A_{PGA} \times (V_{CS_+} - V_{CS_})$$

where A_{PGA} is the selected gain setting of the PGA (2, 10, or 25).

The PGA outputs are routed to the internal 12-bit ADC to internally monitor and/or read through the serial interface. The PGA scales the sensed voltages to fit the input range for the ADC. Program the PGA with gains of 2, 10, and 25 by setting the PG_SET_ bits in the Hardware Configuration register (see Tables 11 and 11c).

To increase the accuracy of drain current measurements, the MAX11008 features a PGA output offset voltage calibration function. The PGA calibration function has two modes of operation: acquisition mode and tracking mode. In acquisition mode, the calibration routine operates continuously until the offset error of the PGA is minimized. In tracking mode, the calibration routine operates intermittently and has higher noise thresholds (more averaging). Typically, the first calibration is performed in acquisition mode and all subsequent calibrations are performed in tracking mode. The PGA Calibration Control register selects the PGA calibration mode and controls when calibrations occur (see the *PGA Calibration Control Register (PGACAL) (Write Only)* section).

Since PGA calibration affects the accuracy of ADC conversion results, avoid performing PGA calibrations when ADC conversions are in progress. Wait at least 2μs (t_{DPUEXT}) after DAC power-up before performing a PGA calibration.

First-In-First-Out (FIFO)

The MAX11008 utilizes a bidirectional FIFO that can store up to eight 16-bit data words. The data stored in the FIFO may consist of ADC conversion results (see the *ADC Monitoring Mode* section), user data that is to

be written to the EEPROM (see the *LUT Streaming Mode* section), or data that is to be read from the EEPROM (see the *Message Mode* section). The data remains in the FIFO until it can be read by the master device through the serial data line (see the *ADC Monitoring Mode* or *Message Mode* section) or written to the EEPROM (see the *LUT Streaming Mode* section). The proceeding sections describe the various modes of operation and data flow control that involve the FIFO.

ADC Monitoring Mode

Setting the ADCMON (D10) bit in the Hardware Configuration register (see Table 11) places the MAX11008 into ADC monitoring mode. The 12-bit ADC conversion result of the selected channel is placed into the FIFO along with a 4-bit channel tag. The 4-bit channel tag is primarily used to indicate the origin of the conversion, and can also be used to indicate that the conversion data may be corrupted during FIFO overflow or that the FIFO is currently empty (see Tables 24 and 24a).

When multiple conversions are made, the FIFO may overflow if data is placed into the FIFO faster than it is read out. In this case, the FIFO stores the seven most recent ADC conversions. When the 8th conversion result enters the FIFO, the oldest conversion is discarded, thereby leaving the seven most recent results. The FIFOOVER bit (D8) in the Flag register (see Table 26) is set to 1 when FIFO overflow occurs.

If the FIFO is full and overflowing on each ADC conversion, there is a narrow timing window in which reading the FIFO produces invalid data. The MAX11008 detects this hazard and flags the data as unreliable by using the channel tag error (1110). Only the data being read through the serial interface is invalid. The ADC sample used internally for V_{GATE_} calculations is valid. To avoid overflow, systematically remove data from the FIFO.

If the ADC data is read out of the FIFO faster than data is transferred into the FIFO, essentially emptying the FIFO, a data word containing the empty FIFO tag (1111) and the current status of the Flag register is read from the FIFO.

LUT Streaming Mode

The LUT streaming mode is used to write data to the EEPROM. Place the MAX11008 in LUT streaming mode by writing to the LUT Streaming register (see Table 27) and disabling the internal watchdog oscillator in the Software Shutdown register. The FIFO is cleared when entering LUT streaming mode, so important data remaining in the FIFO should be read before entering this mode. Write the data that is to be transferred to the EEPROM to the FIFO. The MAX11008 automatically

Dual RF LDMOS Bias Controller with Nonvolatile Memory

moves the data from the FIFO and writes it to the EEPROM. The MAX11008 remains in LUT streaming mode until the specified amount of data is written to the EEPROM. Set the internal watchdog oscillator when LUT streaming mode is exited. If the FIFO is emptied before all of the data is written to the EEPROM, the MAX11008 waits until more data is placed into the FIFO. If data is placed into the FIFO faster than it can be written to the EEPROM causing the FIFO to fill completely, the FIFOOVER bit in the Flag register is set to 1 and all subsequent writes to the FIFO are ignored until there is space for another data word.

The BUSY output goes high during LUT streaming mode and returns low after all of the data is written to the EEPROM.

FIFO data flow control in the LUT streaming mode can be implemented with the following methods:

- 1) Open Loop—Write data to the FIFO at a rate that does not exceed 1 word per 60 μ s to guarantee that the FIFO does not overflow.
- 2) Software Flow Control—Check the FIFOOVER bit (D8) in the Flag register (see Table 26) in between FIFO write commands to ensure that the FIFO is not full; then write data to the FIFO.
- 3) FIFO Status Monitoring—By setting the FIFOSTAT bit (D11) to 1 in the Hardware Configuration register, the ALARM output is used to indicate FIFO status. When the FIFO is full, the ALARM output goes low and returns high when there is space in the FIFO for another data word. See Figures 17 and 18.

Message Mode

Use the message mode to read data from the EEPROM. Write to the user Message register to place the MAX11008 into message mode (see Table 23). The FIFO is cleared when entering message mode, so important data contained in the FIFO should be read before entering this mode. The specified EEPROM data is copied into the FIFO and is read by issuing a FIFO read command. The MAX11008 remains in message mode until all of the specified EEPROM data is copied into and read from the FIFO. If the EEPROM data is copied into the FIFO faster than it is read causing the FIFO to fill completely, the copying action is suspended until a data word is read out of the FIFO and the FIFOOVER bit is set to indicate a not-full condition. If the EEPROM data is read out of the FIFO faster than it can be copied causing the FIFO to empty completely, a data word containing the empty FIFO tag (1111) and current status of the Flag register is read from the FIFO. This underflow data is indistinguishable from arbitrary

EEPROM data, so it is necessary to use data flow-control methods to safely read the EEPROM.

The BUSY output goes high during message mode and returns low after all of the specified EEPROM data is read from the FIFO.

FIFO data flow control in message mode can be implemented with the following methods:

- 1) Open Loop—Read data from the FIFO at a rate no greater than 1 word per 50 μ s, which guarantees that the FIFO does not empty completely before all of the specified data is copied from the EEPROM.
- 2) Software Flow Control—Check the FIFOEMP bit (D9) in the Flag register (see Table 26) in between FIFO read commands to ensure that the FIFO is not empty.
- 3) FIFO Status Monitoring—By setting the FIFOSTAT bit (D11) to 1 in the Hardware Configuration register, the ALARM output is used to indicate FIFO status. When the FIFO is empty, the ALARM output goes low and returns high after more data is copied into the FIFO.

BUSY Output

The BUSY output goes high to show that the MAX11008 is busy for the reasons listed below:

- 1) The ADC is in the middle of a user-commanded conversion cycle (but not in continuous convert mode).
- 2) Power-up initializations are being performed.
- 3) A VGATE_ calculation is being made.
- 4) Data is being read from the EEPROM (message mode).
- 5) Data is being written to the EEPROM (LUT streaming mode).
- 6) One of the PGAs is undergoing calibration.

The serial interface remains active regardless of the state of the BUSY output. Wait until BUSY goes low to read the current conversion data from the FIFO. When BUSY is high, as a result of an ADC conversion, do not enter a second conversion command until BUSY has gone low to indicate the previous conversion is complete.

In multiple conversion mode (CKSEL1, CKSEL0 = 01 or CKSEL1, CKSEL0 = 00), the BUSY signal remains high until all channels have been scanned and the data from the final channel has been moved into the FIFO and checked for alarm limits if enabled (see the *Alarm Software Configuration Register (ALMSCFIG) (Read/Write)* section). In continuous-conversion mode (CONCONV = 1), the BUSY signal does not go high as a result of ADC conversions; however, BUSY does go high when CONCONV is cleared and BUSY remains

Dual RF LDMOS Bias Controller with Nonvolatile Memory

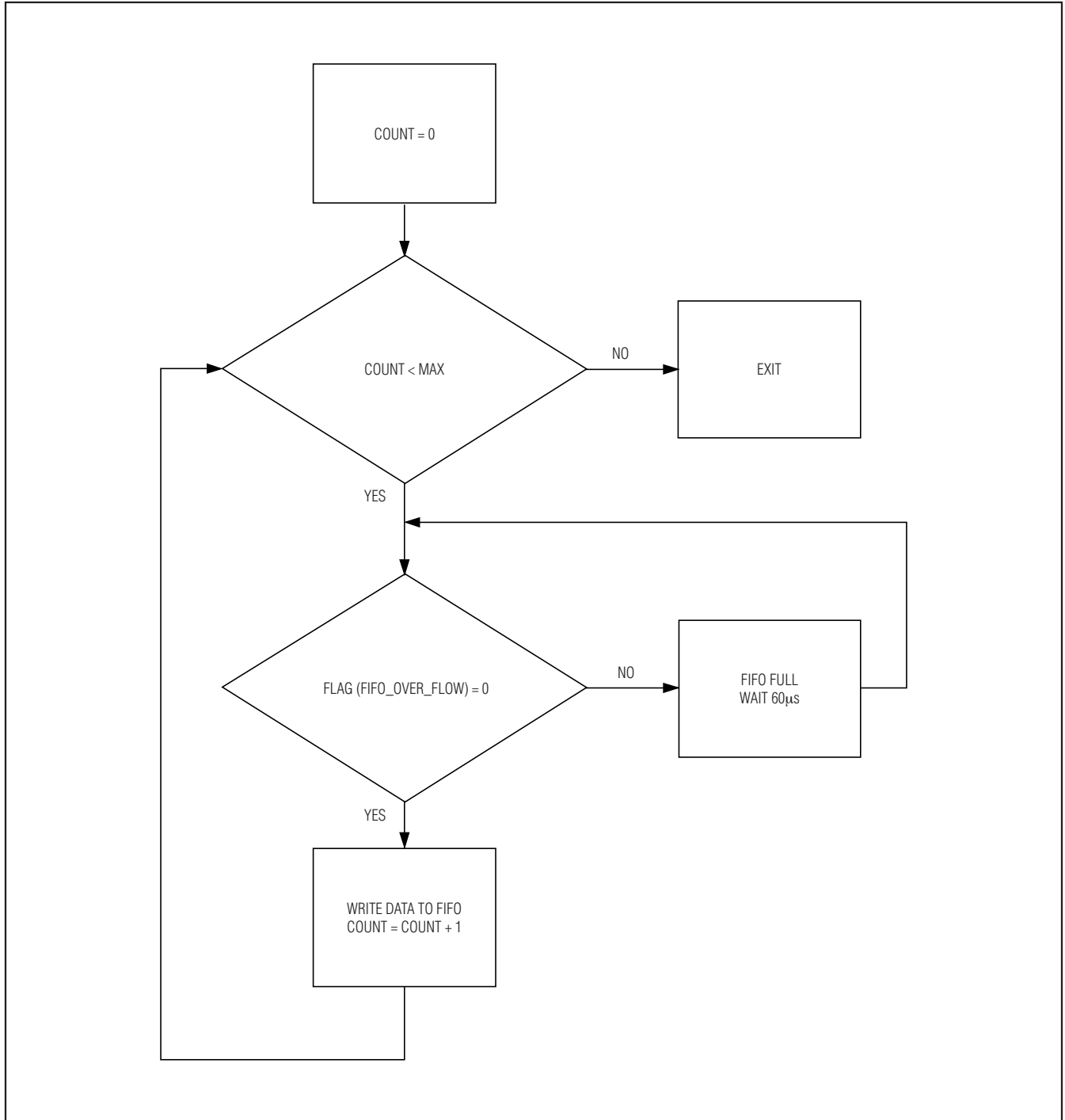

Figure 17. Software Flow Control Example (Pseudo Code)

Dual RF LDMOS Bias Controller with Nonvolatile Memory

MAX11008

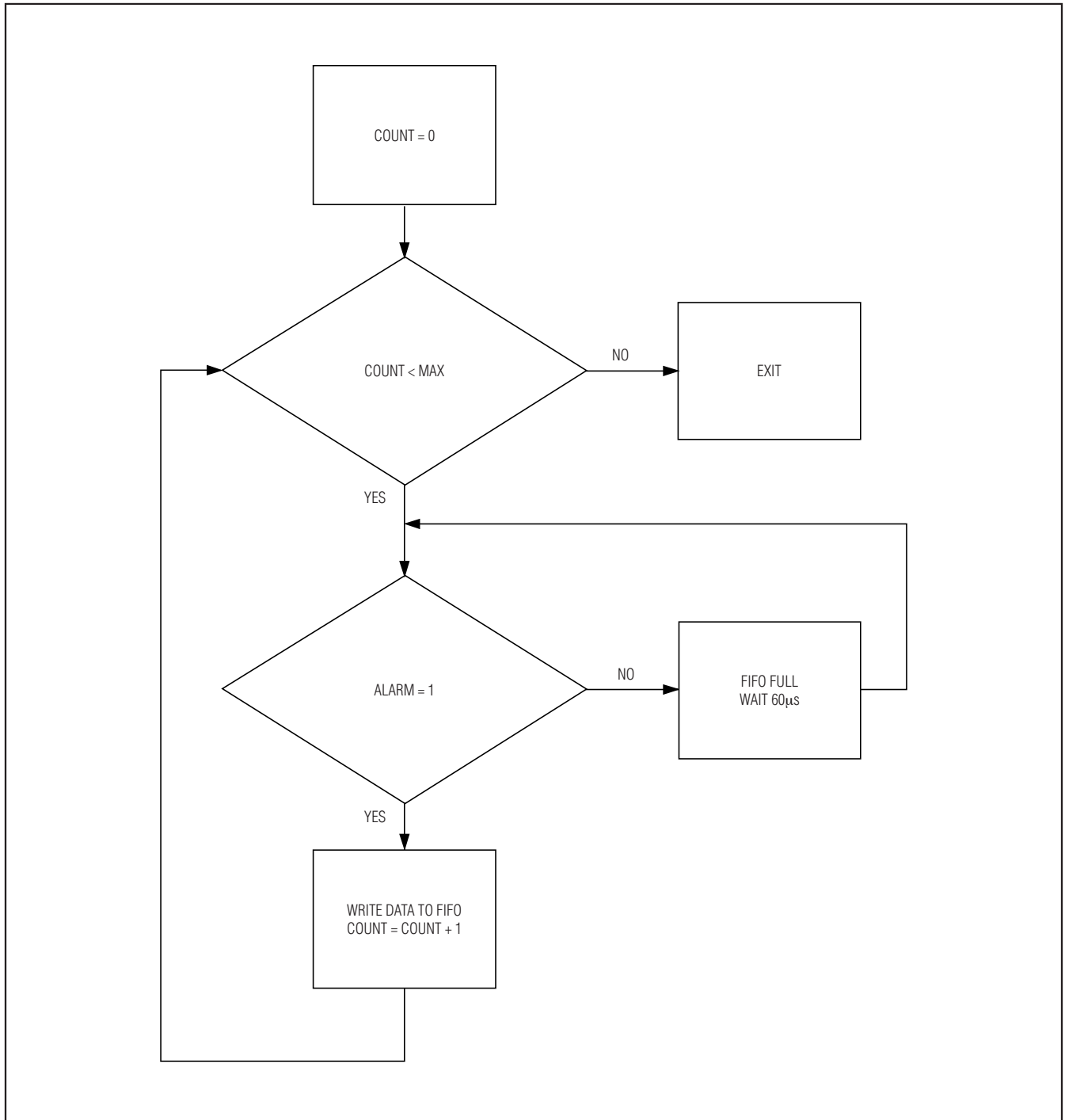

Figure 18. Hardware Flow Control Example (Pseudo Code)

Dual RF LDMOS Bias Controller with Nonvolatile Memory

high until the current scan is complete and the ADC sequence halts. In single-conversion mode (CKSEL1, CKSEL0 = 11), the BUSY signal remains high until the ADC has completed the current conversion (not the entire scan), the data has been moved into the FIFO, and the alarm limits for the channel have been checked (if alarm is enabled).

Alarm Function

The MAX11008 features a multipurpose alarm function that indicates when a temperature sensor or a current-sense amplifier reading exceeds the threshold values specified in the High Temperature Threshold, Low Temperature Threshold, High Current Threshold, and Low Current Threshold registers (see Tables 7 to 10). The thresholds for each temperature sensor and current-sense amplifier channel are set individually and can be configured to operate in window mode or hysteresis mode (see the *Window Mode* and *Hysteresis Mode* sections). Alarm indication is provided by the ALARM output while information on the source of the alarm is contained in the Flag register (see Table 26). The enabling of the various alarms, the polarity of the ALARM output (active-high or active-low), the ALARM-output modes, the alarm-threshold modes, and the methods by which the MAX11008 services an alarm are controlled with the Alarm Software Configuration register and Alarm Hardware Configuration register (see Tables 12 and 14).

ALARM-Output Modes

The ALARM output operates in comparator mode or interrupt mode based on the setting of the ACOMP bit (D8) in the Alarm Hardware Configuration register (see Table 14).

When configured for comparator mode, the ALARM output is asserted when the measured current or temperature value exceeds the set threshold level and is deasserted when the value returns below the set threshold level.

When configured for interrupt mode, the ALARM output is asserted when the measured current/temperature value exceeds the set threshold level and remains asserted until the Flag register is read, at which time the ALARM output is deasserted. The alarm output is only asserted again if the alarm channel recovers and then re-trips (or if a different alarm channel trips).

See Figures 19 and 20 for examples of both ALARM-output modes.

Window Mode

Set the TWIN1 bit (D2) or TWIN2 bit (D6) to 1 in the Alarm Software Configuration register (see Table 12) to

configure the temperature alarm thresholds for channel 1 or channel 2 to window mode. Set the IWIN1 bit (D0) or IWIN2 bit (D4) to 1 in the Alarm Software Configuration register to set the current alarm thresholds for channel 1 or channel 2 to window mode. In window mode, temperature/current measurements are compared to the set temperature/current high and low thresholds. If a measured value is outside the configured window values (between the set high and low thresholds) and that corresponding channel is configured to cause an alarm condition, the alarm asserts. The alarm remains internally asserted until the measured values from that channel fall back into the window and past the configurable hysteresis. The external behavior of ALARM and the gate clamps are controlled by the settings of the ACOMP and ALMCLMP_ bits in the Alarm Hardware Configuration register. The amount of built-in hysteresis can be varied from 8 LSBs to 64 LSBs by setting ALMHYST[1:0] bits (D6 and D7) in the Alarm Hardware Configuration register (see Tables 14 and 14a). See Figures 19 and 20 for window-mode threshold examples.

Hysteresis Mode

Set the TWIN1 bit (D2) or TWIN2 bit (D6) to 0 in the Alarm Software Configuration register (see Table 12) to set the temperature alarm thresholds for channel 1 or channel 2 to hysteresis mode. Set the IWIN1 bit (D0) or IWIN2 bit (D4) to 0 to set the current alarm thresholds for channel 1 or channel 2 to hysteresis mode. In hysteresis mode, temperature or current measurements are compared to the set temperature/current high and low thresholds. If a measured value is above the set high threshold and the corresponding channel is configured to cause an alarm condition, the alarm asserts. ALARM remains internally asserted until the measured values from that channel fall back below the low threshold setting. The external behavior of ALARM and the gate clamps are controlled by the settings of the ACOMP and ALMCLMP_ bits in the Alarm Hardware Configuration register. See Figures 21 and 22 for hysteresis-mode threshold examples.

VGATE_ Output Equation

Based on the monitored LDMOS current analog input voltage and temperature values, the MAX11008 logically decides if the calculated bias voltage, $V_{GATE_}$, driving the gate of the RF LDMOS, should be recalculated and adjusted to maintain the desired RF LDMOS drain current. The MAX11008 independently monitors and calculates the $V_{GATE_}$ voltage for both channel 1 and channel 2. The MAX11008 implements the following equation when calculating $V_{GATE_}$ for each DAC channel:

Dual RF LDMOS Bias Controller with Nonvolatile Memory

MAX11008

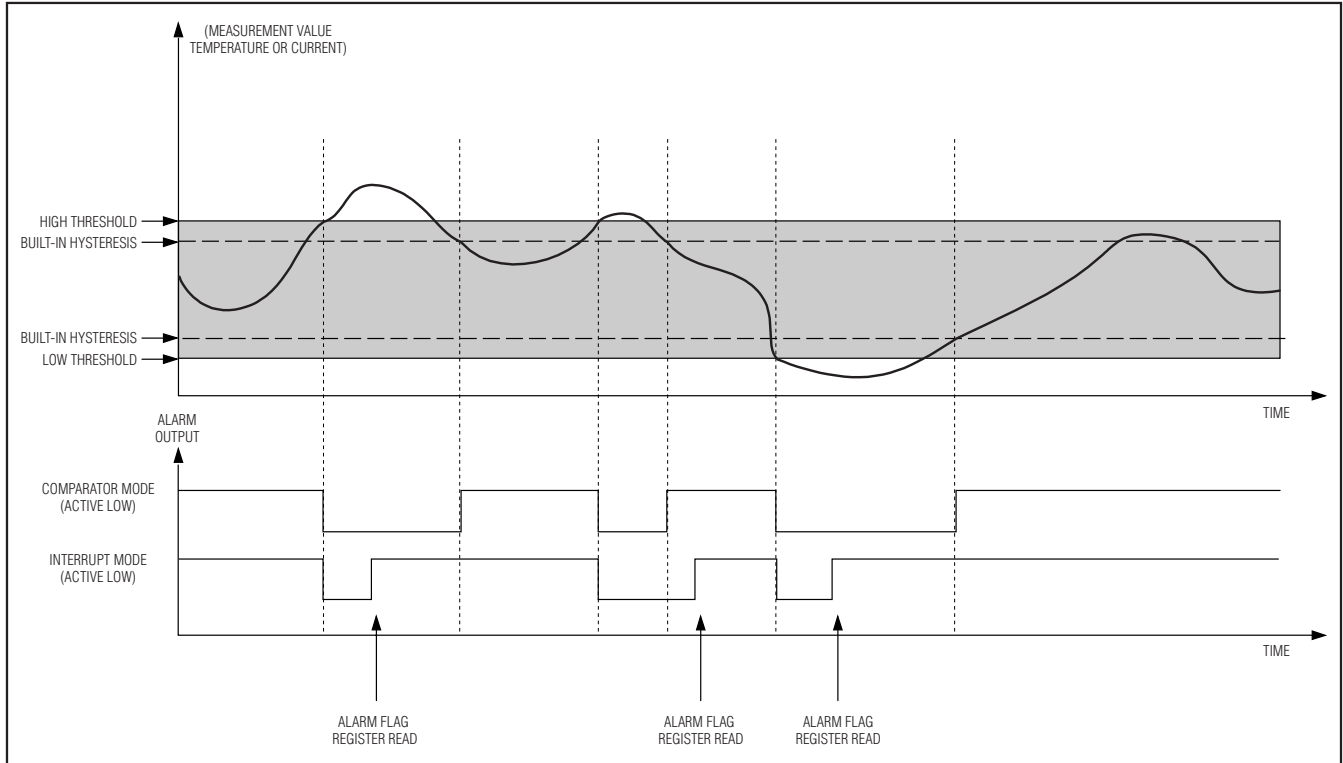

Figure 19. ALARM Output Signal Example—Alarm Thresholds Configured for Window Mode

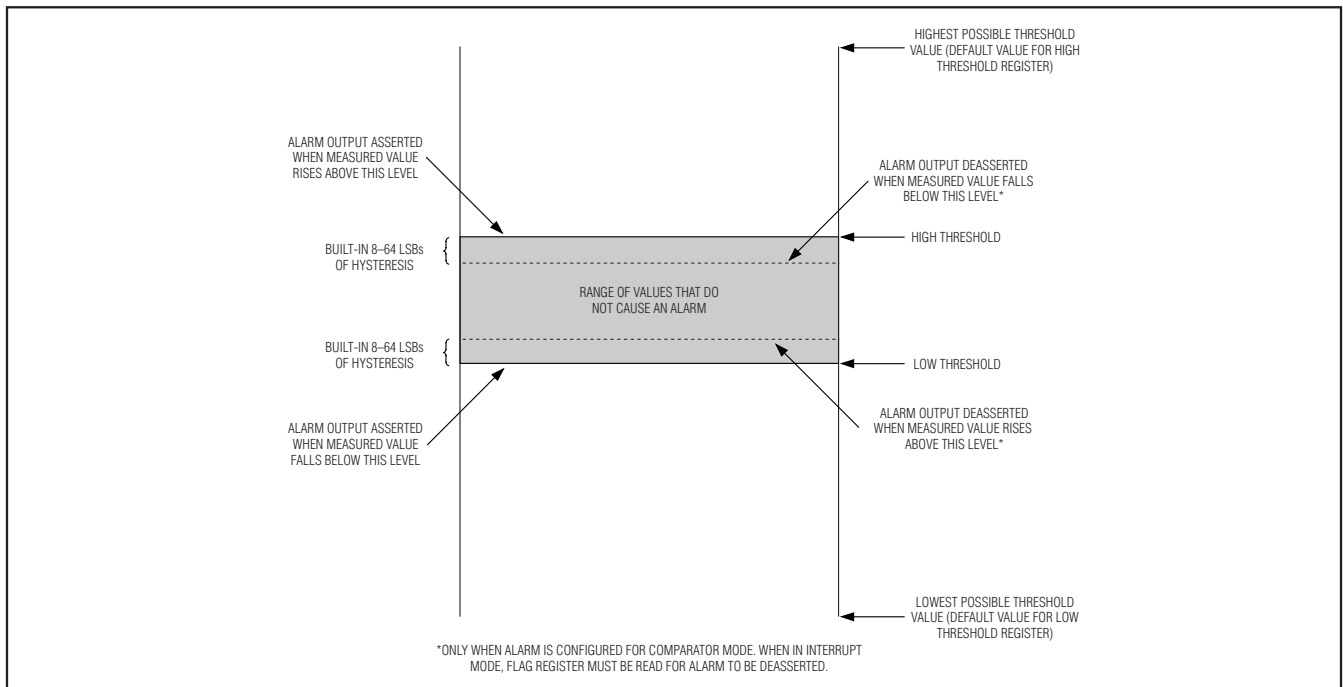

Figure 20. Window-Mode Alarm-Threshold Diagram

Dual RF LDMOS Bias Controller with Nonvolatile Memory

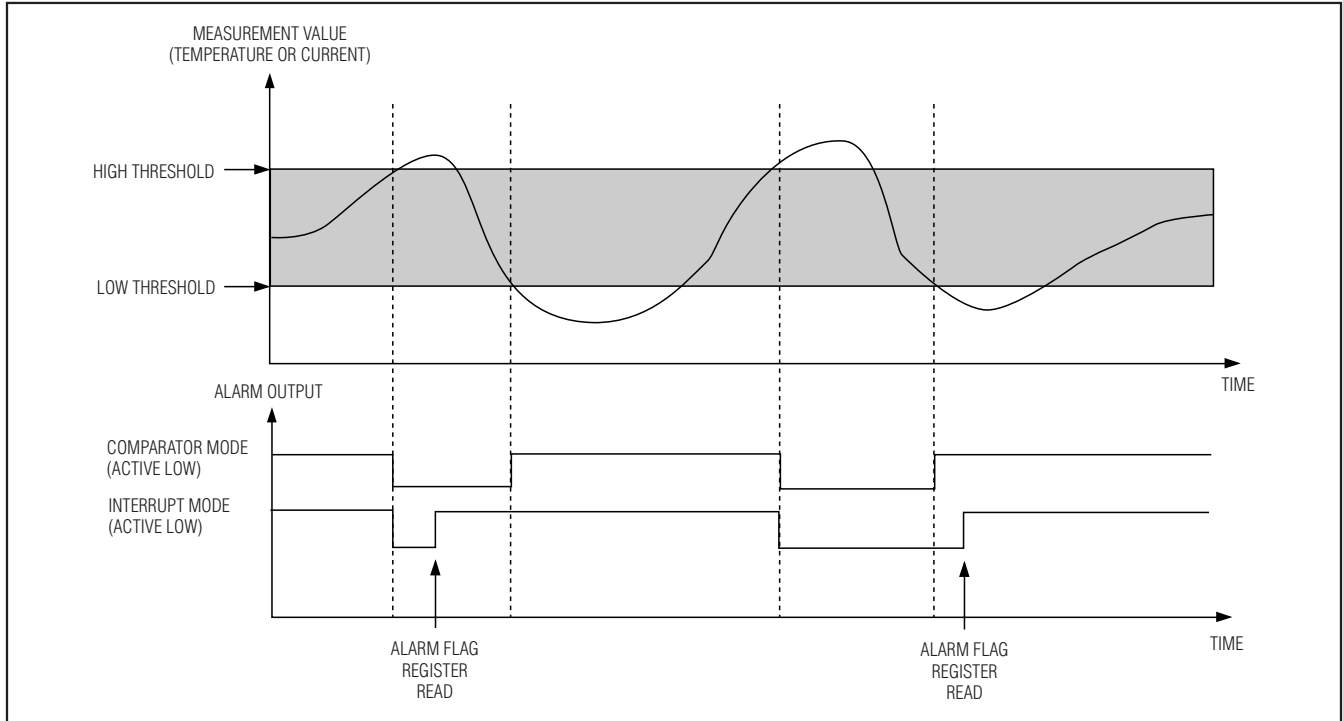

Figure 21. ALARM Output Signal Example—Alarm Thresholds Configured for Hysteresis Mode

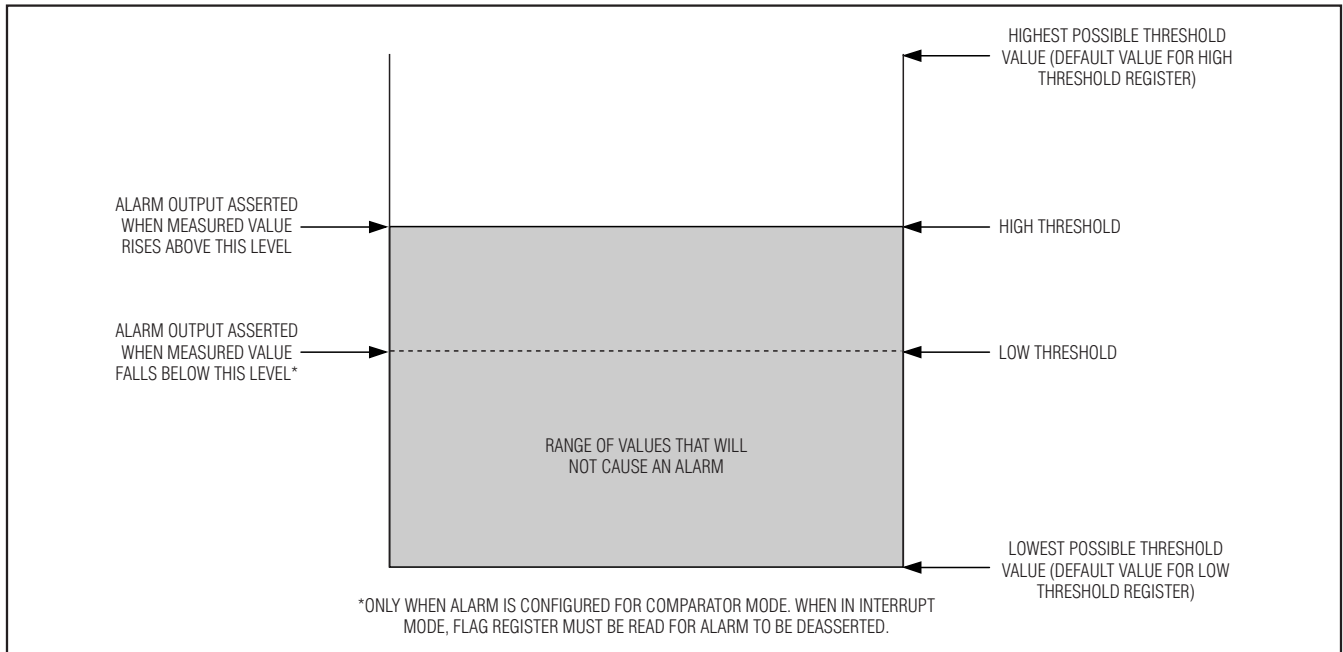

Figure 22. ALARM Output Signal Example—Alarm Thresholds Configured for Hysteresis Mode

Dual RF LDMOS Bias Controller with Nonvolatile Memory

$$\begin{aligned} V_{GATE_} &= (2 \times V_{REFDAC} \times CODE)/4096 \\ &= [2 \times V_{REFDAC} \times (V_{SET_} + LUTTEMP\{Temp\} + \\ &\quad LUTAPC\{APC\})]/4096 \end{aligned}$$

where:

$V_{GATE_}$ = actual gate voltage.

$V_{SET_}$ = factory-set DAC code at TCAL.

LUTTEMP{Temp} = interpolated lookup value in the TEMP table for the sampled temperature.

LUTAPC{APC} = interpolated lookup value in the APC table for the APC parameter.

TCAL = temperature at which LUTTEMP{TCAL} returns 0; i.e., the calibration temperature.

$V_{SET_}$ is a 12-bit unsigned DAC code (0 to 4095). LUTTEMP{Temp} and LUTAPC{APC} are the result of lookup operations and are 16-bit signed numbers in DAC CODE units. The MAX11008 calculates the sum of ($V_{SET_} + LUTTEMP\{Temp\} + LUTAPC\{APC\}$) with 16-bit signed arithmetic and limits that result to the 12-bit resolution of the DAC (0 to 4095) to arrive at the final output DAC CODE.

The LUT values for Temp (LUTTEMP{Temp}) and APC (LUTAPC{APC}) are the result of lookup table operations (LUT operations). The values are directly stored in the LUT sections of the EEPROM. They are 16-bit signed (two's complement) quantities, but to prevent mathematical overflow, their magnitude should be limited to 12-bit quantities (-4096 to +4095, which is the full range of the DAC ignoring the sign).

When averaging is disabled, $V_{GATE_}$ operations proceed as follows:

- 1) A new ADC sample is measured and compared to the last sample used for a $V_{GATE_}$ calculation.
- 2) The absolute difference between the two ADC measurements is compared to the hysteresis setting. If the difference is equal to or greater than the hysteresis setting, the new sample is used to recalculate $V_{GATE_}$. If the hysteresis setting is not exceeded, the following steps are bypassed and $V_{GATE_}$ is not recalculated.
- 3) The ADC sample is converted to a pointer for the LUT. The mechanism for this is explained in the following section, but the process turns the 12-bit ADC sample into an n-bit pointer.
- 4) The lookup operation is performed, and if required, an interpolation between two table values is calculated. The result from the lookup table is stored as either LUTTEMP{Temp} or LUTAPC{APC}.

- 5) The $V_{GATE_}$ equation is now calculated and depending on the status of the LDAC_ bit, output to the appropriate DAC. The actual value of the DAC output depends on the values within the LUT. It is possible that the new value for $V_{GATE_}$ is the same as the last value for $V_{GATE_}$, even though the hysteresis in step 2 was exceeded.

If averaging is enabled for either the temperature or APC parameter, the $V_{GATE_}$ calculation process is the same. The difference is that the value for the ADC sample (step 1 and step 3) is replaced by an ADC average. The MAX11008 measures 16 samples to acquire an initial average. When averaging is enabled, the first 15 samples do not trigger a new average, and a $V_{GATE_}$ calculation is not triggered. After the average is acquired, each new ADC sample produces a new rolling average. The rolling average is calculated with the following equations.

In acquire mode:

$$\text{Average} = \sum_{j=0}^{15} \text{Sample}/16$$

Average is only valid after 16 samples.

In tracking mode:

$$\begin{aligned} \text{Average} &= 15/16 \text{ Average} + 1/16 \text{ Sample} \\ &= 15/16 \text{ Average} + 1/16 (\text{Average} + \text{Difference}) \end{aligned}$$

where:

$$\begin{aligned} \text{Difference} &= \text{Sample} - \text{Average} \\ &= \text{Average} + 1/16 \text{ Difference} \\ &= \text{Average} + 1/16 (\text{Limited Difference}) \end{aligned}$$

The limited difference between the sample and the average is a maximum value that is set by the T_LIMIT and A_LIMIT bits, which are used to reject spurious noise. Difference limiting may be set from 1 LSB to 64 LSBs, or may be disabled altogether.

By setting the A_AVGCTL and T_AVGCTL bits, the average tracking formula can be altered to add 1/4 of the difference on each calculation, rather than 1/16. This reduces the filter's time constant and allows the average to track faster moving signals, and is most suited to the APC channel. The A_AVGCTL and T_AVGCTL bits do not alter the formula for acquiring the initial average.

If the APC[11:0] value is used instead of an ADC sample for the APC sample, all averaging and hysteresis functions are bypassed. The serial interface directly controls the APC[11:0] value and triggers a $V_{GATE_}$ calculation each time it is written.

Dual RF LDMOS Bias Controller with Nonvolatile Memory

Table 4. EEPROM Address Map

WORD ADDRESS			INTERFACE (CUSTOMER) COMMAND		
BIN	DEC	HEX	MNEMONIC	TABLE	COMMENT
0000 0000	0	0	—	—	Unused. User data may be stored here.
0000 0001	1	1	—	—	
0000 0010	2	2	—	—	
0000 0011	3	3	—	—	
0000 0100	4	4	—	—	
0000 0101	5	5	—	—	
0000 0110	6	6	—	—	
0000 0111	7	7	—	—	
0000 1000	8	8	—	—	
0000 1001	9	9	—	—	
0000 1010	10	0A	—	—	
0000 1011	11	0B	—	—	
0000 1100	12	0C	—	—	
0000 1101	13	0D	—	—	
0000 1110	14	0E	—	—	
0000 1111	15	0F	—	—	
0001 0000	16	10	EE_TH1	7	Nonvolatile alarm trip points (DPRAM locations)
0001 0001	17	11	EE_TL1	8	
0001 0010	18	12	EE_1H1	9	
0001 0011	19	13	EE_IL1	10	
0001 0100	20	14	EE_TH2	7	
0001 0101	21	15	EE_TL2	8	
0001 0110	22	16	EE_IH2	9	
0001 0111	23	17	EE_IL2	10	
0001 1000	24	18	EE_HCFIG	11	Nonvolatile configuration (DPRAM locations)
0001 1001	25	19	EE_ALMSCF	12	
0001 1010	26	1A	EE_SCFIG	13	
0001 1011	27	1B	EE_ALMHCF	14	
0001 1100	28	1C	EE_VSET1	15	
0001 1101	29	1D	EE_HIST_AP	16a, 16b	
0001 1110	30	1E	EE_VSET2	15	
0001 1111	31	1F	EE_HIST_AP	16a, 16b	

Dual RF LDMOS Bias Controller with Nonvolatile Memory

MAX11008

Table 4. EEPROM Address Map (continued)

WORD ADDRESS			INTERFACE (CUSTOMER) COMMAND		
BIN	DEC	HEX	MNEMONIC	TABLE	COMMENT
0010 0000	32	20	—	—	Unused. User data may be stored here.
0010 0001	33	21	—	—	
0010 0010	34	22	—	—	
0010 0011	35	23	—	—	
0010 0100	36	24	—	—	
0010 0101	37	25	—	—	
0010 0110	38	26	—	—	
0010 0111	39	27	—	—	
0010 1000	40	28	—	—	
0010 1001	41	29	—	—	
0010 1010	42	2A	—	—	
0010 1011	43	2B	—	—	
0010 1100	44	2C	EE_IDAC1	17	
0010 1101	45	2D	EE_IODAC1	18	—
0010 1110	46	2E	EE_IDAC2	17	—
0010 1111	47	2F	EE_IODAC2	18	—
0011 0000	48	30	EE_PGACAL	19	—
0011 0001	49	31	EE_ADCCON	20	—
0011 0010	50	32	EE_SSHUT	21	—
0011 0011	51	33	EE_LDAC	22	—
0011 0100	52	34	Reserved	—	—
0011 0101	53	35	Reserved	—	—
0011 0110	54	36	Reserved	—	—
0011 0111	55	37	MAGIC NUMBER	—	AA55
0011 1000	56	38	Reserved	—	—
0011 1001	57	39	Reserved	—	—
0011 1010	58	4A	Reserved	—	—
0011 1011	59	4B	Reserved	—	—
0011 1100	60	4C	EE_TLUT1	5	LUT configuration
0011 1101	61	4D	EE_ALUT1	5	
0011 1110	62	4E	EE_TLUT2	5	
0011 1111	63	4F	EE_ALUT2	5	

Dual RF LDMOS Bias Controller with Nonvolatile Memory

EEPROM

The MAX11008 features 4Kb of EEPROM capable of storing up to 256 16-bit data words. The first 64 data words of the EEPROM contain configuration data (see Table 4) while the remaining 192 data words are programmable and used for storing temperature and APC LUTs. The MAX11008 utilizes the LUT values to perform gate voltage calculations (see the *V_{GATE}_ Output Equation* section). See the *First-In-First-Out (FIFO), LUT Streaming Mode*, and *Message Mode* sections for more information on how to program and read from the EEPROM. See the *Temperature/APC LUT Configuration Registers* section for information on how to configure the LUTs and how values are retrieved from the LUTs for V_{GATE}_ calculations. See Table 5.

Nonvolatile Initialization Values

Upon power-on reset, the data contained within specific EEPROM locations is copied directly to corresponding locations within the register address map depending on the state of the magic number (see the *Magic Number* section).

- Locations 0x10–0x1F are directly copied to their corresponding locations within the register address map.
- Locations 0x2C–0x33 are conditionally copied to their corresponding locations within the register address map. Set the MSB (labeled WCTRAM) to 1 for locations 0x2C–0x33 to be copied to the register address map (see Table 4a).

By correctly configuring the initialization values stored within the EEPROM, the MAX11008 can automatically enter V_{GATE}_ compensation mode without the need for a host processor. This autonomous operation is useful in some application areas where a host controller is not desired.

Changes made to the working registers during operation are volatile. To change a register's nonvolatile initialization value, the corresponding EEPROM location must be written by the LUT streaming protocol.

Magic Number

The address location 0x37 of the EEPROM is referred to as the magic address. If the magic address is programmed with the magic number (0xAA55), the values stored in address locations 0x10–0x1F and 0x2C–0x33 are loaded into the working registers (see the *Register Address Map* section) during power-up initialization. Address locations 0x10–0x1F are unconditionally loaded into the working registers, whereas address locations 0x2C–0x33 are only loaded if bit D15 (WCTRAM) of the address is set to 1. If magic address location 0x37 is not programmed with the magic number (0xAA55), the EEPROM is determined to be unprogrammed; the power-up initialization load is then bypassed and the working registers default to their power-on reset value.

LUT Values

The values stored within the LUT section of the EEPROM are 16-bit signed (two's complement)

Table 4a. EEPROM Address Bit Map

HEX	MNEMONIC	TABLE	BIT 15	BIT 14	BIT 13	BIT 12	BIT 11	BIT 10	BIT 9	BIT 8	BIT 7	BIT 6	BIT 5	BIT 4	BIT 3	BIT 2	BIT 1	BIT 0	
10	EE_TH1	7	X	X	X	X	D11	D10	D9	D8	D7	D6	D5	D4	D3	D2	D1	D0	
11	EE_TL1	8	X	X	X	X	D11	D10	D9	D8	D7	D6	D5	D4	D3	D2	D1	D0	
12	EE_IH1	9	X	X	X	X	D11	D10	D9	D8	D7	D6	D5	D4	D3	D2	D1	D0	
13	EE_IL1	10	X	X	X	X	D11	D10	D9	D8	D7	D6	D5	D4	D3	D2	D1	D0	
14	EE_TH2	7	X	X	X	X	D11	D10	D9	D8	D7	D6	D5	D4	D3	D2	D1	D0	
15	EE_TL2	8	X	X	X	X	D11	D10	D9	D8	D7	D6	D5	D4	D3	D2	D1	D0	
16	EE_IH2	9	X	X	X	X	D11	D10	D9	D8	D7	D6	D5	D4	D3	D2	D1	D0	
17	EE_IL2	10	X	X	X	X	D11	D10	D9	D8	D7	D6	D5	D4	D3	D2	D1	D0	
18	EE_HCFG	11	T1AVGCTL	T1LIMIT2	T1LIMIT1	T1LIMIT0	FIFOSTAT	ADCOMN	PG2SET1	PG2SET0	PG1SET1	PG1SET0	CKSEL1	CKSEL0	ADCREFP1	ADCREFP0	DACREF1	DACREF0	
19	EE_ALMSCF	12	X	X	X	X	A2AVG	T2AVG	A1AVG	T1AVG	TALARM2	TWIN2	IALARM2	IWIN2	TALARM1	TWIN1	IALARM1	IWIN1	
1A	EE_SCFG	13	T2AVGCTL	T2LIMIT2	T2LIMIT1	T2LIMIT0	LDAC2	TCOMP2	APCCOMP2	TSRC2	APCSRC21	APCSRC20	LDAC1	TCOMP1	APCCOMP1	TSRC1	APCSRC11	APCSRC10	
1B	EE_ALMHCF	14	X	X	X	X	X	AVGMON	INTEMP2	ALMCOMP	ALMHYST1	ALMHYST0	ALMCLMP21	ALMCLMP20	ALMCLMP11	ALMCLMP10	ALMPOL	ALMOPN	
1C	EE_VSET1	15	X	X	X	X	D11	D10	D9	D8	D7	D6	D5	D4	D3	D2	D1	D0	
1D	EE_HIST_AP	16a	T1HIST3	T1HIST2	T1HIST1	T1HIST0	D11	D10	D9	D8	D7	D6	D5	D4	D3	D2	D1	D0	
1D	EE_HIST_AP	16b	T1HIST3	T1HIST2	T1HIST1	T1HIST0	X	X	X	X	A1AVGCTL	A1LIMIT2	A1LIMIT1	A1LIMIT0	A1HIST3	A1HIST2	A1HIST1	A1HIST0	
1E	EE_VSET2	15	X	X	X	X	D11	D10	D9	D8	D7	D6	D5	D4	D3	D2	D1	D0	
1F	EE_HIST_AP	16a	T1HIST3	T1HIST2	T1HIST1	T1HIST0	D11	D10	D9	D8	D7	D6	D5	D4	D3	D2	D1	D0	
1F	EE_HIST_AP	16b	T2HIST3	T2HIST2	T2HIST1	T2HIST0	X	X	X	X	A2AVGCTL	A2LIMIT2	A2LIMIT1	A2LIMIT0	A2HIST3	A2HIST2	A2HIST1	A2HIST0	
2C	EE_IDAC1	17	WCTRAM	X	X	X	D11	D10	D9	D8	D7	D6	D5	D4	D3	D2	D1	D0	
2D	EE_JODAC1	18	WCTRAM	X	X	X	D11	D10	D9	D8	D7	D6	D5	D4	D3	D2	D1	D0	
2E	EE_IDAC2	17	WCTRAM	X	X	X	D11	D10	D9	D8	D7	D6	D5	D4	D3	D2	D1	D0	
2F	EE_JODAC2	18	WCTRAM	X	X	X	D11	D10	D9	D8	D7	D6	D5	D4	D3	D2	D1	D0	
30	EE_PGACAL	19	WCTRAM	X	X	X	X	X	X	X	X	X	X	X	X	X	TRACK	DOCAL	SELFTIME
31	EE_ADCCON	20	WCTRAM	X	X	X	X	X	X	X	CONCONV	ADGIN2	CS2	EXTTEMP2	ADGIN1	CS1	EXTEMP1	INTEMP	
32	EE_SSHUT	21	WCTRAM	X	X	X	X	X	X	X	X	X	X	X	FBGON	OSCPD	DAC2PD	DAC1PD	
33	EE_LDAC	22	WCTRAM	X	X	X	X	X	X	X	X	X	X	X	X	X	DAC_CH2	DAC_CH1	
37	MAGIC NUMBER	---	1	0	1	0	1	0	1	0	1	0	1	0	1	0	1	0	1
3C	EE_TLUT1	5	POFF5	POFF4	POFF3	POFF2	POFF1	POFF0	INT1	INT0	PSIZE1	PSIZE0	TSIZE2	TSIZE1	TSIZE0	SOT2	SOT1	SOT0	
3D	EE_ALUT1	5	POFF5	POFF4	POFF3	POFF2	POFF1	POFF0	INT1	INT0	PSIZE1	PSIZE0	TSIZE2	TSIZE1	TSIZE0	SOT2	SOT1	SOT0	
3E	EE_TLUT2	5	POFF5	POFF4	POFF3	POFF2	POFF1	POFF0	INT1	INT0	PSIZE1	PSIZE0	TSIZE2	TSIZE1	TSIZE0	SOT2	SOT1	SOT0	
3F	EE_ALUT2	5	POFF5	POFF4	POFF3	POFF2	POFF1	POFF0	INT1	INT0	PSIZE1	PSIZE0	TSIZE2	TSIZE1	TSIZE0	SOT2	SOT1	SOT0	

Dual RF LDMOS Bias Controller with Nonvolatile Memory

quantities. But to avoid the possibility of mathematical overflow, the magnitude of the values should be limited to 12 bits (-4096 to +4095, which allows full movement over the range of the 12-bit DAC).

Temperature/APC LUT Configuration Registers

The LUT Configuration register (see Table 5) specifies the location and the size of the temperature and automatic power control (APC) LUTs. The EEPROM can be configured to have a total of four LUTs (one temperature LUT for each temperature-sensor channel and one APC LUT for each DAC channel). These registers can only be programmed when the device is in LUT streaming mode and are set while data is being streamed into the LUT. The data contained in the LUT Configuration registers is stored in the EEPROM.

When $V_{GATE_}$ calculations are made using temperature and/or APC LUT values, the MAX11008 uses a LUT pointer to retrieve the correct values for the calculation. The LUT pointer value is derived from the most recent 12-bit ADC measurement or directly transferred from the APC Parameter register (see Table 16). The source of the LUT pointer value depends on the settings of the Software Configuration register (see Table 13). PSIZE determines the size of the LUT pointer (see Table 5a). TSIZE specifies the size of the table (see Table 5c). It is permissible to use an LUT pointer that is larger than the table indexed. An 8-bit pointer functions properly with a LUT of 32 data locations. The LUT pointer values that extend beyond the table are limited to the upper (or lower) bound of the table. This technique increases the effective table resolution when the dynamic range of ADC samples is limited.

The POFF bits set the offset value that is added to the resulting LUT pointer value. POFF is a signed 6-bit value that is used to apply both positive and negative offset values to the LUT pointer. The range of acceptable offset values depends on PSIZE (see Table 5a). POFF is typically used for temperature LUTs that have LUT data for 0°C measurements located at the center of the LUT. For example, if a temperature LUT has 64 data locations (locations 0 through 63), the data for 0°C is located at the center of the LUT (location 31). If a temperature measurement is made at 0°C, the resulting ADC conversion is 0, which instructs the LUT pointer to retrieve data from the first location (location 0) in the LUT. To retrieve the correct data for 0°C (location 31), a pointer offset of 31 needs to be added to the LUT pointer.

To increase the accuracy of $V_{GATE_}$ calculations, the MAX11008 can linearly interpolate intermediate temperature and APC compensation values from the two closest LUT data locations. To accomplish this, fractional bits are added to the LUT pointer by setting the INT bits

(see Table 5b). When INT = 00 the LUT pointer has no fractional bits and no interpolation is performed. When INT = 00, every LUT pointer corresponds directly to a table entry. If INT = 01, the LUT pointer has 1 fractional bit, which represents a fractional 1/2. This represents an LUT pointer that falls midway between two table entries, and the MAX11008 performs a linear interpolation between those two entries. Similarly, INT = 10 provides 2 fractional bits (1/4 resolution or 4:1 interpolation), and INT = 11 provides 3 fractional bits (1/8 resolution or 8:1 interpolation). See the *Calculating an LUT Pointer from an ADC Sample/APC Parameter* section for a detailed description and examples on calculating LUT pointer values.

The SOT bits set the starting addresses of each corresponding LUT in the EEPROM (see Table 5d). Each table starts at one of six possible locations within the EEPROM memory space. It is also possible to make several LUT tables occupy the same memory space within the EEPROM by simply setting identical SOT values. This is useful when temperature or APC data is common to both channels. This allows a single shared table of double the resolution to be implemented instead of two separate identical tables.

Tables 5e and 5f contain examples on how to configure the LUTs in EEPROM using the TSIZE, SOT, and PSIZE bits.

Calculating an LUT Pointer from an ADC Sample/APC Parameter

Calculate the LUT pointer value using the following steps:

- 1) The 12-bit ADC value is first shifted to the right by the number of bits as determined by the following equation:
$$\text{12-bit ADC value right shift} = 7 - \text{PSIZE} - \text{INT}$$
where PSIZE and INT are the decimal values of PSIZE and INT in the LUT Configuration register. The LUT pointer is interpreted as a fixed-point fractional number where PSIZE specifies the number of integer bits and INT specifies the number of fractional bits.
- 2) The pointer offset value is left-shifted in the following manner:
If PSIZE = 00 or 01, no shifting is performed.
If PSIZE = 10, POFF is shifted to the left by 1 bit.
If PSIZE = 11, POFF is shifted to the left by 2 bits.
POFF is interpreted as a signed number.
- 3) The resulting POFF value is added to the LUT pointer value.

Dual RF LDMOS Bias Controller with Nonvolatile Memory

- 4) The resulting LUT pointer value is bound-limited to ensure it fits within the corresponding LUT. Negative pointer values are limited to zero, and pointer values that extend beyond the range of the LUT are limited to the last entry.
- 5) The final LUT pointer value is calculated by shifting SOT to the left by 5 bits and then adding it to the current LUT pointer value. If no linear interpolation (INT = 00) is to be performed, the resulting LUT pointer value is equal to the absolute EEPROM address from which the LUT data is retrieved. If linear interpolation is to be performed (INT = 01, 10, or 11), the two LUT addresses that are closest to the resulting LUT pointer value and their corresponding data values are entered into the following equation to calculate the interpolated data value that is used in the VGATE_ calculation:

$$\text{Interpolated Data} = \text{DATA1} + \left(\frac{\text{PTR} - \text{ADD1}}{\text{ADD2} - \text{ADD1}} \right) \times (\text{DATA2} - \text{DATA1})$$

Table 5. Temperature/APC LUT Configuration Register

DATA BITS	BIT NAME	RESET STATE	FUNCTION
D[15:10]	POFF	000000	POFF bits.
D[9:8]	INT	00	Interpolation degree select bits. See Table 5b.
D[7:6]	PSIZE	00	LUT pointer size bit. See Table 5a.
D[5:3]	TSIZE	000	LUT size bit. See Table 5c.
D[2:0]	SOT	000	Start of table address bits. See Table 5d.

Table 5a. LUT Pointer Sizes and Offset Ranges

PSIZE	LUT POINTER SIZE	POFF OFFSET RANGE*
00	5-bit pointer (access up to 32 data locations)	-32 to +31
01	6-bit pointer (access up to 64 data locations)	-32 to +31
10	7-bit pointer (access up to 128 data locations)	-64 to +62 (in steps of 2)
11	8-bit pointer (access up to 256 data locations)	-128 to +124 (in steps of 4)

*POFF is either a negative or positive number. When POFF is negative its value is represented in two's complement format.

where PTR is the calculated LUT pointer value with fractional bits, ADD1 and ADD2 are the two LUT addresses closest to the value of PTR, and DATA1 and DATA2 are the LUT data values stored at ADD1 and ADD2.

LUT Pointer Example 1 (No Interpolation)

POFF = 001000 (offset of +8).

INT = 00 (no interpolation/LUT pointer does not have any fractional bits).

PSIZE = 00 (5-bit LUT pointer not including any fractional bits).

TSIZE = 001 (LUT has 32 data locations).

SOT = 010 (LUT starts at EEPROM address 40 hex).

Table 5b. Fractional Bits Added to LUT Pointer for Linear Interpolation

INT	NUMBER OF FRACTIONAL BITS ADDED TO LUT POINTER
00	0
01	1 ≥ 1:2 interpolation
10	2 ≥ 1:4 interpolation
11	3 ≥ 1:8 interpolation

Table 5c. Selectable LUT Sizes

TSIZE	LUT SIZE
000	Unused
001	Table size of 32 data locations
010	Table size of 64 data locations
011	Table size of 96 data locations
100	Table size of 128 data locations
101	Table size of 160 data locations
110	Table size of 192 data locations
111	Unused

Table 5d. Selectable LUT Starting Addresses

SOT	STARTING ADDRESS IN EEPROM (HEX)
000	Unused
001	Unused
010	0x40
011	0x60
100	0x80
101	0xA0
110	0xC0
111	0xE0

Dual RF LDMOS Bias Controller with Nonvolatile Memory

Table 5e. LUT Configuration Examples

REGISTER ENTRY	CONFIGURATION 1 (EXAMPLE)	CONFIGURATION 2 (EXAMPLE)	CONFIGURATION 3 (EXAMPLE)	CONFIGURATION 4 (EXAMPLE)
Temperature LUT1	POFF = 010100 INT = 00 PSIZE = 01 TSIZE = 010 SOT = 100 0x5054	POFF = 010100 INT = 00 PSIZE = 01 TSIZE = 010 SOT = 100 0x5054	POFF = 100000 INT = 00 PSIZE = 10 TSIZE = 100 SOT = 010 0x40A2	Unused (TCOMP in Software Configuration register should be set to 0)
APC LUT1	POFF = 000000 INT = 00 PSIZE = 00 TSIZE = 001 SOT = 010 0x000A	POFF = 000000 INT = 00 PSIZE = 01 TSIZE = 010 SOT = 010 0x0052	POFF = 000000 INT = 00 PSIZE = 10 TSIZE = 100 SOT = 100 0x00A4	POFF = 000000 INT = 00 PSIZE = 11 TSIZE = 110 SOT = 010 0x00F2
Temperature LUT2	POFF = 100000 INT = 00 PSIZE = 10 TSIZE = 010 SOT = 110 0x4096	POFF = 010100 INT = 00 PSIZE = 01 TSIZE = 010 SOT = 110 0x5056	POFF = 100000 INT = 00 PSIZE = 10 TSIZE = 010 SOT = 010 0x4092	Unused (TCOMP in Software Configuration register should be set to 0)
APC LUT2	POFF = 000000 INT = 00 PSIZE = 00 TSIZE = 001 SOT = 011 0x000B	POFF = 000000 INT = 00 PSIZE = 01 TSIZE = 010 SOT = 010 0x0052	POFF = 000000 INT = 00 PSIZE = 01 TSIZE = 010 SOT = 010 0x00A4	POFF = 000000 INT = 00 PSIZE = 11 TSIZE = 110 SOT = 010 0x00F2

Table 5f. Visual Example of LUT

WORD ADDRESS	CONFIGURATION 1 (EXAMPLE)	CONFIGURATION 2 (EXAMPLE)	CONFIGURATION 3 (EXAMPLE)	CONFIGURATION 4 (EXAMPLE)
0x00 to 0x0F	Dedicated user message			
0x10 to 0x3F	Configuration data			
0x40 to 0x5F	APC LUT1 32 x 16 bits	Unified APC LUT 64 x 16 bits	Unified Temperature LUT 64 x 16 bits	Unified APC LUT 192 x 16 bits
0x60 to 0x7F	APC LUT2 32 x 16 bits			
0x80 to 0x9F	Temperature LUT1 64 x 16 bits	Temperature LUT1 64 x 16 bits	Unified APC LUT 128 x 16 bits	
0xA0 to 0xBF				
0xC0 to 0xDF	Temperature LUT2 64 x 16 bits	Temperature LUT2 64 x 16 bits		
0xE0 to 0xFF				

Dual RF LDMOS Bias Controller with Nonvolatile Memory

ADC sample = 495 hex

<< x indicates a logical shift left by x number of bits.

>> x indicates a logical shift right by x number of bits.

- 1) LUT pointer = ADC sample >> (7 - PSIZE - INT)
= 495 hex >> (7 - 0 - 0)
= 495 hex >> 7
= 9 hex (9 decimal)
- 2) POFF = POFF << 0
= 001000 bin << 0
= 001000 bin
= 8 hex (8 decimal)
- 3) LUT pointer = LUT pointer + POFF
= 9 hex + 8 hex
= 11 hex (17 decimal)
- 4) Test LUT pointer is within the table size
Is $0 \leq \text{LUT pointer} \leq 31$?
Yes, LUT pointer does not need limiting to table size.
LUT pointer = 11 hex (17 decimal)
- 5) EEPROM address = (SOT << 5) + LUT pointer
= (010 << 5) + 11 hex
= 40 hex + 11 hex
= 51 hex (81 decimal)
- 6) The LUT data at EEPROM address 51 hex is used for the VGATE_ calculation.

LUT Pointer Example 2 (With Interpolation)

POFF = 101000 (offset of -24)

INT = 10 (linear interpolation required/LUT pointer has 2 fractional bits)

PSIZE = 10 (7-bit LUT pointer not including any fractional bits)

TSIZE = 100 (LUT has 128 data locations)

SOT = 100 (LUT starts at EEPROM address 80 hex)

ADC sample = E6A hex

<< x indicates a logical shift left by x number of bits.

>> x indicates a logical shift right by x number of bits.

- 1) LUT pointer = ADC sample >> (7 - PSIZE - INT)
- 2) = E6A hex >> (7 - 2 - 2)
= E6A hex >> 3
= 1CD hex (461 decimal)
= 111001101 bin
= 1110011.01 bin in 7.2 fixed-point format
= 73.4 hex in 7.2 fixed-point format (115.25 decimal)

Since the LUT pointer is a fixed point fractional number with 7 integer bits and 2 fractional bits, the LUT pointer value of 1CD hex is interpreted as 73.4 hex (115.25 decimal).

- 3) POFF = POFF << 1
= 101000 bin << 1
= 1010000 bin
= D0 hex (-48 decimal)
- 4) LUT pointer = LUT pointer + POFF
= 73.4 hex (115.25 decimal) + D0 hex (-48 decimal)
= 43.4 hex (67.25 decimal)
- 5) Test LUT pointer is within the table size
Is $0 \leq \text{LUT pointer} \leq 127$?
Yes, LUT pointer does not need limiting.
LUT pointer = 43.4 hex (67.25 decimal).
= (100 << 5) + LUT pointer
= 80 hex + 43.4 hex
= C3.4 hex (195.25 decimal)

The EEPROM address is a fixed-point fractional number (C3.4 hex), which falls between table entries at address C3 hex and C4 hex. Linear interpolation is performed between these two entries.

ADD1 = C3 hex (195 decimal)

ADD2 = C4 hex (196 decimal)

The interpolated data is calculated using ADD1 and ADD2 and the corresponding data stored at these address locations using the linear interpolation equation:

$$\text{Interpolated Data} = \text{LUT}[\text{ADD1}] + \left(\frac{\text{EEPROM Address} - \text{ADD1}}{\text{ADD2} - \text{ADD1}} \right) \times (\text{LUT}[\text{ADD2}] - \text{LUT}[\text{ADD1}])$$

$$\text{Interpolated Data} = \text{LUT}[\text{C3 Hex}] + \left(\frac{195.25 - 195}{196 - 195} \right) \times (\text{LUT}[\text{C4 Hex}] - \text{LUT}[\text{C3 Hex}])$$

$$\text{Interpolated Data} = \text{LUT}[\text{C3 Hex}] + (0.25) \times (\text{LUT}[\text{C4 Hex}] - \text{LUT}[\text{C3 Hex}])$$

where LUT[C3 hex] and LUT[C4] are the data values stored at EEPROM addresses C3 hex and C4 hex.

Register Address Map

Table 6 lists the addresses for all of the 16-bit registers that are accessible through the serial interface. To read from and write to these registers, follow the proper SPI or I²C read and write sequences described in the *Digital Serial Interface* section. Bit C7 in the command byte controls whether data is written to or read from the register. This is not the same bit as the I²C read/write

Dual RF LDMOS Bias Controller with Nonvolatile Memory

that is sent with the slave address (see the *Register Address/Data Bytes (5-Byte Read Cycle)* section).

Tables 7 to 27 describe each register in detail.

Register Descriptions

High Temperature Threshold Registers (TH1, TH2) (Read/Write)

The High Temperature Threshold registers set the upper alarm thresholds for each temperature sensor channel (see Table 7). The temperature value is entered into the register in the same format as the ADC temperature conversion results, which is a 12-bit signed (two's complement) fixed-point number with the 3 LSBs being the fractional bits. See the *Alarm Function* section for more information on configuring the alarm thresholds.

When the MAX11008 is powered up for the first time, the high temperature threshold is set to the maximum value (0111 1111 1111 = +255.875°C) by default. After initial power-up, the high temperature threshold value can be initialized from the EEPROM.

Low Temperature Threshold Registers (TL1, TL2) (Read/Write)

The Low Temperature Threshold registers set the lower alarm thresholds for each temperature sensor channel (see Table 8). The temperature value is entered into the register in the same format as the ADC temperature conversion results, which is a 12-bit signed (two's complement) fixed-point number with the 3 LSBs being the fractional bits. See the *Alarm Function* section for more information on configuring the alarm thresholds.

When the MAX11008 is powered up for the first time, the low temperature threshold is set to the minimum value (1000 0000 0000 = -256.0°C) by default. After initial power-up, the low temperature threshold value can be initialized from the EEPROM.

High Current Threshold Registers (IH1, IH2) (Read/Write)

The High Current Threshold registers set the upper alarm thresholds for each current-sense amplifier channel (see Table 9). The current threshold value is entered into the register in the same format as the ADC current conversion results, which is a 12-bit unsigned binary. See the *Alarm Function* section for more information on configuring the alarm thresholds.

When the MAX11008 is powered up for the first time, the high current threshold is set to the maximum value

(1111 1111 1111) by default. After initial power-up, the high current threshold can be set to the desired value. The high current threshold value can be initialized from the EEPROM.

Low Current Threshold Registers (IL1, IL2) (Read/Write)

The Low Current Threshold registers set the lower alarm thresholds for each current-sense amplifier channel (see Table 10). The current threshold value is entered into the register in the same format as the ADC current conversion results, which is a 12-bit unsigned binary. See the *Alarm Function* section for more information on configuring the alarm thresholds.

When the MAX11008 is powered up for the first time, the low current threshold is set to the minimum value (0000 0000 0000) by default. After initial power-up, the low current threshold can be set to the desired value. The low current threshold value can be initialized from the EEPROM.

Hardware Configuration Register (HCFIG) (Read/Write)

Select FIFO status indication through the ALARM output, ADC monitoring mode, ADC clock modes, PGA gain settings, DAC reference modes, and ADC reference modes by setting bits D[11:0] in the Hardware Configuration register (see Table 11).

Set T1AVGCTL to 1 to enable the channel 1 averaging-equation bit. The T1AVGCTL bit controls the averaging equation for channel 1 while the device is in tracking mode. The T1AVGCTL bit only affects the tracking mode of the averaging. The bit does not affect the acquirement of the initial average. The initial average always requires 16 samples to generate a valid average. Set T1AVGCLT to 0 for the average plus 1/16 difference. Set T2AVGCLT to 1 for the average plus 1/4 difference. See Table 11a.

Program T1LIMIT[2:0] to enable and set the difference limiter for channel 1 temperature averaging. The channel 1 temperature average must be enabled for the contents of T1LIMIT[2:0] to have any effect on the measured data (see the *Alarm Software Configuration Register (ALMSCFIG)* (Read/Write) section). The T1LIMIT[2:0] field only affects the tracking mode of the average function. When tracking the average, the difference between the current average and the new sample is calculated. The difference is then added into the average according to the T1AVGCTL bit. However, before being added, the difference is limited according to the T1LIMIT[2:0] field. See Table 11b.

Dual RF LDMOS Bias Controller with Nonvolatile Memory

Table 6. Register Address Map

REGISTER	MNEMONIC	SEE TABLE	COMMAND BITS								HEX CODE		
			C7	C6	C5	C4	C3	C2	C1	C0	WRITE	READ	
Channel 1 High Temperature Threshold	TH1	7	R \overline{W}	0	1	0	0	0	0	0	0	20	A0
Channel 2 High Temperature Threshold	TH2	7	R \overline{W}	0	1	0	1	0	0	0	0	28	A8
Channel 1 Low Temperature Threshold	TL1	8	R \overline{W}	0	1	0	0	0	1	0	0	22	A2
Channel 2 Low Temperature Threshold	TL2	8	R \overline{W}	0	1	0	1	0	1	0	0	2A	AA
Channel 1 High Current Threshold	IH1	9	R \overline{W}	0	1	0	0	1	0	0	0	24	A4
Channel 1 Low Current Threshold	IL1	9	R \overline{W}	0	1	0	0	1	1	0	0	26	A6
Channel 2 High Temperature Threshold	IH2	10	R \overline{W}	0	1	0	1	1	0	0	0	2C	AC
Channel 2 Low Temperature Threshold	IL2	10	R \overline{W}	0	1	0	1	1	1	0	0	2E	AE
Hardware Configuration	HCFIG	11	R \overline{W}	0	1	1	0	0	0	0	0	30	B0
Alarm Software Configuration	ALMSCFIG	12	R \overline{W}	0	1	1	0	0	1	0	0	32	B2
Software Configuration	SCFIG	13	R \overline{W}	0	1	1	0	1	0	0	0	34	B4
Alarm Hardware Configuration	ALMHCFIG	14	R \overline{W}	0	1	1	0	1	1	0	0	36	B6
VSET1	VSET1	15	R \overline{W}	0	1	1	1	0	0	0	0	38	B8
VSET2	VSET2	15	R \overline{W}	0	1	1	1	1	0	0	0	3C	BC
APC1 Parameter	HIST_APC1	16	R \overline{W}	0	1	1	1	0	1	0	0	3A	BA
APC2 Parameter	HIST_APC2	16	R \overline{W}	0	1	1	1	0	1	0	0	3E	BE
DAC1 Input (Write Only)	IDAC1	17	0	1	0	1	1	0	0	0	0	58	—
DAC2 Input (Write Only)	IDAC2	17	0	1	0	1	1	1	0	0	0	5C	—
DAC1 Input and Output (Write Only)	IODAC1	18	0	1	0	1	1	0	1	0	0	5A	—
DAC2 Input and Output (Write Only)	IODAC2	18	0	1	0	1	1	1	1	0	0	5E	—
PGA Calibration Control (Write Only)	PGACAL	19	0	1	1	0	0	0	0	0	0	60	—
ADC Conversion (Write Only)	ADCCON	20	0	1	1	0	0	0	1	0	0	62	—
Software Shutdown (Write Only)	SSHUT	21	0	1	1	0	0	1	0	0	0	64	—
Load DAC (Write Only)	LDAC	22	0	1	1	0	0	1	1	0	0	66	—
Message (Write Only)	—	23	0	1	1	0	1	1	1	0	0	6E	—
FIFO	—	24	R \overline{W}	1	1	1	0	0	1	0	0	72	80
Software Clear (Write Only)	SCLR	25	0	1	1	1	0	1	0	0	0	74	—
LUT Streaming (Write Only)	—	27	0	1	1	1	1	1	1	0	0	7E	—
Flag (Read Only)	—	26	1	1	1	1	0	1	1	0	0	—	F6

The following properties of the register address map should be noted:

- All register data is volatile.
- Data stored in locations TH1, TH2, TL1, TL2, IH1, IH2, IL1, IL2, HCFIG, ALMSCFIG, SCFIG, ALMHCFIG, VSET1, VSET2, IDAC1, IDAC2, IODAC1, IODAC2, PGACAL, ADCCON, SSHUT, and LDAC can be loaded from EEPROM at power-up or after a full reset.
- Write to the FIFO register only in LUT streaming mode (see the *LUT Streaming Mode* section).

Dual RF LDMOS Bias Controller with Nonvolatile Memory

Set FIFOSTAT to 1 to use the ALARM output to monitor the data flow of the FIFO while in LUT streaming mode or message mode. See the *LUT Streaming Mode* and *Message Mode* sections for more information on these modes of operation and how to use the ALARM output for FIFO flow control.

Set ADCMON to 1 to copy ADC conversion results into the FIFO where it can be read out through the serial interface. See the *ADC Monitoring Mode* section for more information on reading conversion results from the FIFO. ADCMON and AVGMON cannot be active at the same time.

Program PG_SET[1:0] to set the channel 1 and channel 2 current-sense amplifier gain (see Table 11c).

Program CKSEL[1:0] to set the conversion and acquisition timing clock modes (see Table 11d). See the *Internally Timed Acquisitions and Conversions* section for detailed descriptions of each clock mode.

Program ADCREF[1:0] to establish the source of the ADC reference (see Table 11e). Program the DACREF[1:0] to establish the source of the DAC reference (see Table 11f). See the *ADC and DAC References* section for more information on configuring the data converter references.

Alarm Software Configuration Register (ALMSCFIG) (Read/Write)

Configure the software alarm functions with bits D[11:0] in the Alarm Software Configuration register (see Table 12). Bits D[15:12] are don't-care bits.

Set A_AVG to 1 to enable the APC averaging and filtering function for channel 1 and channel 2. The APCSRC_ field in the SCFG register controls the source of the sample.

Table 7. High Temperature Threshold Register

DATA BITS	BIT NAME	RESET STATE	FUNCTION
D[15:12]	Unused	X	Unused bits.
D[11:D0]	THI[11:0]	0111 1111 1111	High temperature threshold data bits.

X = Don't care.

Table 8. Low Temperature Threshold Register

DATA BITS	BIT NAME	RESET STATE	FUNCTION
D[15:12]	Unused	X	Unused bits.
D[11:0]	TLO[11:0]	1000 0000 0000	Low temperature threshold data bits.

X = Don't care.

Table 9. High Current Threshold Register

DATA BITS	BIT NAME	RESET STATE	FUNCTION
D[15:12]	Unused	X	Unused bits.
D[11:0]	IHI[11:0]	1111 1111 1111	High current threshold data bits.

X = Don't care.

Table 10. Low Current Threshold Register

DATA BITS	BIT NAME	RESET STATE	FUNCTION
D[15:12]	Unused	X	Unused bits.
D[11:0]	ILO[11:0]	0000 0000 0000	Low current threshold data bits.

X = Don't care.

Dual RF LDMOS Bias Controller with Nonvolatile Memory

Table 11. Hardware Configuration Register

DATA BITS	BIT NAME	RESET STATE	FUNCTION
D15*	T1AVGCTL	0	Channel 1 averaging-equation bit. This bit controls the averaging equation for channel 1 while the device is in tracking mode. See Table 11a.
D[14:12]*	T1LIMIT[2:0]	000	Channel 1 difference-limiter bits. Set T1LIMIT[2:0] to enable the difference limiter for channel 1 temperature averaging. See Table 11b.
D11	FIFOSTAT	0	If the FIFOSTAT bit is set to 1, the ALARM output is used to monitor data flow into/out of the FIFO and EEPROM while in the message and LUT streaming modes.
D10	ADCMON	0	ADC monitor enable bit. If ADCMON is set to 1, the result from the ADC conversion is copied into the FIFO, from where it can be read over the serial interface. If ADCMON = 0, the result is not copied into the FIFO. ADCMON and AVGMON cannot be active at the same time.
D[9:8]	PG2SET[1:0]	00	PGA2 gain-setting bits. See Table 11c.
D[7:6]	PG1SET[1:0]	00	PGA1 gain-setting bits. See Table 11c.
D[5:4]	CKSEL[1:0]	00	Clock mode and $\overline{\text{CNVST}}$ bits. See Table 11d.
D[3:2]	ADCREF[1:0]	00	ADC reference select bits. See Table 11e.
D[1:0]	DACREF[1:0]	00	DAC reference select bits. See Table 11f.

X = Don't care.

*Write only.

Table 11a. Channel 1 Averaging Equation (T1AVGCTL)

D15	CHANNEL 1 AVERAGING EQUATION
0	Average = average + 1/16 difference.
1	Average = average + 1/4 difference.

Table 11b. Channel 1 Difference-Limiter Bits (T1LIMIT[2:0])

D14	D13	D12	CHANNEL 2 DIFFERENCE-LIMITER BITS (T2LIMIT[2:0])
0	0	0	No limiting is applied.
0	0	1	Difference is limited to 1 LSB (1/8 of a degree).
0	1	0	Difference is limited to 3 LSBs (3/8 of a degree).
0	1	1	Difference is limited to 7 LSBs (7/8 of a degree).
1	0	0	Difference is limited to 15 LSBs (1 7/8 degrees).
1	0	1	Difference is limited to 31 LSBs (3 7/8 degrees).
1	1	0	Difference is limited to 63 LSBs (7 7/8 degrees).
1	1	1	Difference is limited to 127 LSBs (15 7/8 degrees).

Dual RF LDMOS Bias Controller with Nonvolatile Memory

Table 11c. PGA1 and PGA2 Gain Setting Bits (PG_SET[1:0])

PG_SET1	PG_SET0	PGA GAIN
0	0	2
0	1	10
1	X	25

X = Don't care.

Table 11d. Clock Mode and $\overline{\text{CNVST}}$ Bit (CKSEL[1:0])

CKSEL1	CKSEL0	ADC CONVERSION TYPE
0	0	Internally timed acquisitions and conversions start by writing to the ADC Conversion register and enabling one or more channels. See the <i>ADC Conversion Register (ADCCON) (Write Only)</i> section. All of the selected channels are sequentially converted each time the ADC Conversion register is written to.
0	1	Internally timed acquisitions and conversions start by asserting a low pulse at $\overline{\text{CNVST}}$ whenever one or more channels are enabled in the ADC Conversion register. All of the selected channels are sequentially converted each time a low pulse is asserted at $\overline{\text{CNVST}}$.
1	0	Reserved. Do not use.
1	1	Selected channels are converted individually each time $\overline{\text{CNVST}}$ is pulled low. Each low pulse on $\overline{\text{CNVST}}$ converts the next channel in the sequence.

X = Don't care.

Table 11e. ADC Reference Configuration Bits (ADCREF[1:0])

ADCREF1	ADCREF0	ADC REFERENCE
0	X	ADC uses external reference voltage supplied at the ADCREF input.
1	0	ADC uses internal reference voltage.
1	1	ADC uses internal reference voltage. Connect external decoupling capacitor at REFADC for better noise performance.

X = Don't care.

Table 11f. DAC Reference Configuration Bits (DACREF[1:0])

DACREF1	DACREF0	DAC REFERENCE
0	X	DAC uses external reference voltage supplied at the DACREF input.
1	0	DAC uses internal reference voltage.
1	1	DAC uses internal reference voltage. Connect external decoupling capacitor at REFDAC for better noise performance.

X = Don't care.

Dual RF LDMOS Bias Controller with Nonvolatile Memory

Set T_AVG to 1 to enable the temperature averaging and filtering function for channel 1 and channel 2. The TSRC_ field in the SCFG register controls the source of the sample.

Set TALARM_ to 1 to enable and to 0 to disable the alarm function for channel 1 and channel 2 temperature measurements.

Set TWIN_ to 0 to configure the channel 1 and channel 2 temperature alarms for hysteresis mode, and set TWIN_ to 1 to configure the channel 1 and channel 2 temperature alarms for window mode. See the *Hysteresis Mode* and *Window Mode* sections for detailed descriptions of each alarm mode. Use the Alarm Hardware Configuration register to set the value of hysteresis when in window mode (see Tables 14 and 14a).

Set IALARM_ to 1 to enable and to 0 to disable the alarm function for channel 1 and channel 2 current measurements.

Set IWIN_ to 0 to configure the channel 1 and channel 2 current-sense alarm for hysteresis mode, and set IWIN_ to 1 to configure the channel 1 and channel 2 current-sense alarm for window mode. See the *Hysteresis Mode* and *Window Mode* sections for detailed descriptions of each alarm mode. Use the Alarm Hardware Configuration register to set the value of hysteresis when in window mode (see Tables 14 and 14a).

Software Configuration Register (SCFG) (Read/Write)

Bits D[15:0] in the Software Configuration register (see Table 13) control the parameters that trigger VGATE_ calculations, how the results of the VGATE_ calculation are applied (APC and/or temperature compensation), and whether the calculation result is written to the DAC input register only or to both input and output registers. The register also determines the source of the APC and temperature parameters, which are used to calculate the LUT pointer for retrieving LUT values (see the *Temperature/APC LUT Configuration Registers* section). The data stored in the Software Configuration register can be initialized from the EEPROM. Table 13d summarizes all of the possible VGATE_ calculation trigger conditions that can be set by the Software Configuration register.

Set T2AVGCTL to 1 to enable the channel 2 averaging-equation bit. The T2AVGCTL bit controls the averaging equation for channel 2 while the device is in tracking mode. The T2AVGCTL bit only affects the tracking mode of the averaging. The bit does not affect the

acquisition of the initial average. The initial average always requires 16 samples to generate a valid average. Set T2AVGCLT to 0 for average plus 1/16 of the difference. Set T2AVGCLT to 1 for average plus 1/4 of the difference. See Table 13a.

Program T2LIMIT[2:0] to enable and set the difference limiter for channel 2 temperature averaging. The channel 2 temperature average must be enabled for the contents of the T2LIMIT[2:0] field to have any effect on the measured data (see the *Alarm Software Configuration Register (ALMSCFIG) (Read/Write)* section). The T2LIMIT[2:0] field only affects the tracking mode of the average function. When tracking the average, the difference between the current average and the new sample is calculated. The difference is then added into the average according to the T2AVGCTL bit, but before being added the difference is limited according to the T2LIMIT[2:0] field. See Table 13b.

Set LDAC_ to 0 to load the VGATE_ calculation result into the channel 1 and channel 2 DAC input and output registers, forcing the VGATE_ output to change as soon as the VGATE_ calculation is completed. Set LDAC_ to 1 to load the calculation result into the channel 1 and channel 2 DAC input registers. Transfer the results from the input register to the output register by writing to the Load DAC register (see the *Load DAC Register (LDAC) (Write Only)* section).

Set TCOMP_ to 1 to allow VGATE_ calculations to be triggered by changes in channel 1 and channel 2 temperature measurements. In this mode, the VGATE_ calculation includes a temperature LUT value. The temperature measurement values that trigger VGATE_ calculations depend on the settings of T_HIST[3:0] in the APC Parameter register.

Set APCCOMP_ to 1 to allow VGATE_ calculations to be triggered by changes in channel 1 and channel 2 current-sense measurements or the APC parameter in the APC Parameter register. In this mode, the VGATE_ calculation includes an APC LUT value. The current measurement values that trigger VGATE_ calculations depend on the settings of A_HIST[3:0] in the APC Parameter register.

Set TSRC_ to 0 to use the channel 1 and channel 2 external temperature sensor as the source of the temperature parameter for VGATE_ calculations. Set TSRC_ to 1 to use the internal temperature sensor as the source of the temperature parameter for VGATE_ calculations.

Set APCSRC[1:0] to select the source of the APC parameter used for VGATE_ calculations (see Table 13c).

Dual RF LDMOS Bias Controller with Nonvolatile Memory

Alarm Hardware Configuration Register (ALMHCFG) (Read/Write)

Configure the hardware alarm functions with bits D[10:0] in the Alarm Hardware Configuration register (see Table 14). Bits D[15:11] are don't-care bits.

Set AVGMON to 1 to write ADC averages to the FIFO. The tracking average has a unique channel tag and is distinguishable from the raw sample. The average monitoring is automatically suspended when in LUT streaming and message modes. ADCMON and AVGMON cannot be active at the same time.

Set INTEMP2 to 1 to configure the channel 2 temperature alarm to monitor the internal temperature sensor readings rather than the channel 2 external temperature sensor. The status of the alarm is indicated by the channel 2 temperature flags in the flag register. The current-sense alarm for channel 2 is no longer available in this mode.

Set ALMCOMP to 1 to configure the ALARM output for comparator mode, and set ALMCOMP to 0 to configure the ALARM output for interrupt mode. See the *ALARM-Output Modes* section for a detailed description of each type of ALARM output mode.

Program ALMHYST[1:0] to set the amount of hysteresis that is applied to the alarm thresholds when the alarm function is configured for window mode (see Table 14a). See the *Window Mode* section for a detailed description of how the hysteresis is applied.

Set ALMCLMP[1:0] to control the methods to clamp the GATE_ to AGND when an alarm is triggered (see Table 14b).

Set ALMPOL to 1 to configure the ALARM output to be active-low, and set ALMPOL to 0 to configure the ALARM output to be active-high.

Set ALMOPEN to 1 to configure the ALARM output for an open-drain output (pullup resistor required), and set ALMOPEN to 0 for a push-pull output.

VSET Registers (VSET1, VSET2) (Read/Write)

The VSET registers set the nominal GATE_ output code without any temperature or APC compensation (see Table 15). This value is input into the VGATE_ calculation (see the *VGATE_ Output Equation* section). Writing to this register triggers a VGATE_ calculation, and the result of that calculation is loaded into either the DAC_ input register or the DAC_ input and output registers depending on the state of the LDAC_ bit in the Software Configuration register. Bits D[15:12] are don't-care bits.

T_HIST_APC Registers (HIST_APC1, HIST_APC2) (Read/Write)

The T_HIST_APC registers are dual-functionality registers. The function of the T_HIST_APC registers depends upon the value of APCSRC_[1:0] bits in the Software Configuration register (see Table 13). If APCSRC_[1:0] = 00, the T_HIST_APC registers hold the APC parameter and the temperature hysteresis controls (see Table 16a). If APCSRC_[1:0] = 10 or 11, the T_HIST_APC registers hold the APC averaging and hysteresis controls as well as temperature hysteresis controls (see Table 16b).

The T_HIST register bits T_HIST[3:0] set the temperature hysteresis limits for both channel 1 and channel 2 VGATE_ calculations. After a new temperature sample, the device proceeds in performing a VGATE_ calculation if that sample differs from the previous sample used for a VGATE_ calculation by an amount greater than the hysteresis setting (see Table 16c). Set APCCOMP_ and TCOMP_ to 0 before T_HIST is changed.

The APC register bits (APC[11:0]) set the value that is converted into the LUT pointer value, which is subsequently used to retrieve the APC LUT value for VGATE_ calculations (see Table 16a). This value is used only when APCSRC_1 is set to 0 in the Software Configuration register. Writing to this register triggers a VGATE_ calculation when APCSRC_1 is set to 0 and APCCOMP_ is set to 1 in the Software Configuration register.

The A_AVGCTL bit controls the averaging equation for APC while the device is in tracking mode. The A_AVGCTL bit only affects the tracking mode of the averaging. The bit does not affect the acquirement of the initial average. The initial average always requires 16 samples to generate a valid average. Set A_AVGCLT to 0 for average plus 1/16 of the difference. Set A_AVGCTL to 1 for average plus 1/4 of the difference (see Table 16c).

Program A_LIMIT[2:0] to enable and set the difference limiter for APC averaging. The APC average must be enabled for the contents of the A_LIMIT[2:0] field to have any effect on the measured data. The A_LIMIT[2:0] field only affects the tracking mode of the average function. When tracking the average, the difference between the current average and the new sample is calculated. The difference is then added into the average according to the A_AVGCTL bit, but before being added the difference is limited according to the A_LIMIT[2:0] field (see Table 16d).

Dual RF LDMOS Bias Controller with Nonvolatile Memory

Table 12. Alarm Software Configuration Register

DATA BITS	BIT NAME	RESET STATE	FUNCTION
D[15:12]	Unused	X	Unused bits.
D11*	A2AVG	0	Channel 2 APC averaging and filtering bit. Set to 1 to enable the APC averaging and filtering function for channel 2. The source of the sample is controlled by the APCSRC2 field in the Software Configuration register.
D10*	T2AVG	0	Channel 2 temperature averaging and filtering bit. Set to 1 to enable the temperature averaging and filtering function for channel 2. The source of the sample is controlled by the TSRC2 field in the Software Configuration register.
D9*	A1AVG	0	Channel 1 APC averaging and filtering bit. Set to 1 to enable the APC averaging and filtering function for channel 1. The source of the sample is controlled by the APCSRC1 field in the Software Configuration register.
D8*	T1AVG	0	Channel 1 temperature averaging and filtering bit. Set to 1 to enable the temperature averaging and filtering function for channel 1. The source of the sample is controlled by the TSRC1 field in the Software Configuration register.
D7	TALARM2	0	Channel 2 temperature alarm enable bit. Set TALARM2 to 1 to enable the channel 2 temperature alarm.
D6	TWIN2	0	Channel 2 temperature alarm window bit. Set to 0 for hysteresis mode, and set to 1 for window mode. See the <i>Hysteresis Mode</i> and <i>Window Mode</i> sections.
D5	IALARM2	0	Channel 2 current alarm enable bit. Set IALARM2 to 1 to enable the channel 2 current alarm.
D4	IWIN2	0	Channel 2 current alarm window bit. Set to 0 for hysteresis mode, and set to 1 for window mode. See the <i>Hysteresis Mode</i> and <i>Window Mode</i> sections.
D3	TALARM1	0	Channel 1 temperature alarm enable bit. Set TALARM1 to 1 to enable the channel 1 temperature alarm.
D2	TWIN1	0	Channel 1 temperature alarm window bit. Set to 0 for hysteresis mode, and set to 1 for window mode. See the <i>Hysteresis Mode</i> and <i>Window Mode</i> sections.
D1	IALARM1	0	Channel 1 current alarm enable bit. Set IALARM1 to 1 to enable the channel 1 current alarm.
D0	IWIN1	0	Channel 1 current alarm window bit. Set to 0 for hysteresis mode, and set to 1 for window mode. See the <i>Hysteresis Mode</i> and <i>Window Mode</i> sections.

X = Don't care.

*Write only.

Dual RF LDMOS Bias Controller with Nonvolatile Memory

MAX11008

Table 13. Software Configuration Register

DATA BITS	BIT NAME	RESET STATE	FUNCTION
D15*	T2AVGCTL	0	Channel 2 averaging-equation bit. This bit controls the averaging equation for channel 2 while the device is in tracking mode. See Table 13a.
D[14:12]*	T2LIMIT[2:0]	000	Channel 2 difference-limiter bits. Set T2LIMIT[2:0] to enable the difference limiter for channel 2 temperature averaging. See Table 13b.
D11	LDAC2	0	Channel 2 LDAC control bit. Set to 0 to load calculation results into the DAC 2 input and output registers. Set to 1 to load calculation results into the DAC 2 input register only.
D10	TCOMP2	0	Channel 2 temperature compensation enable bit. Set to 1 to allow VGATE2 calculations to be triggered by channel 2 temperature measurements.
D9	APCCOMP2	0	Channel 2 APC parameter compensation enable bit. Set to 1 to allow VGATE2 calculations to be triggered by channel 2 current-sense measurements or APC2 parameter changes.
D8	TSRC2	0	Channel 2 temperature sensor select bit. Set to 0 to use the channel 2 external temperature sensor as the source of the temperature parameter for VGATE2 calculations. Set to 1 to use the internal temperature sensor.
D[7:6]	APCSRC2[1:0]	00	Channel 2 APC parameter select bits. Set APCSRC2[1:0] to select the data source for VGATE2 calculations. See Table 13c.
D5	LDAC1	0	Channel 1 LDAC control bit. Set to 0 to load calculation results into the DAC 1 input and output registers. Set to 1 to load calculation results into the DAC 1 input register only.
D4	TCOMP1	0	Channel 1 temperature compensation enable bit. Set to 1 to allow VGATE1 calculations to be triggered by channel 1 temperature measurements.
D3	APCCOMP1	0	Channel 1 APC parameter compensation enable bit. Set to 1 to allow VGATE1 calculations to be triggered by channel 1 current-sense measurements or APC1 parameter changes.
D2	TSRC1	0	Channel 1 temperature sensor select bit. Set to 0 to use the channel 1 external temperature sensor as the source of the temperature parameter for VGATE1 calculations. Set to 1 to use the internal temperature sensor.
D[1:0]	APCSRC1[1:0]	00	Channel 1 APC parameter select bits. Set APCSRC1[1:0] to select the data source for VGATE1 calculations. See Table 13c.

X = Don't care.

*Write only.

Dual RF LDMOS Bias Controller with Nonvolatile Memory

Table 13a. Channel 2 Averaging Equation (T2AVGCTL)

D15	CHANNEL 2 AVERAGING EQUATION
0	Average = average + 1/16 difference.
1	Average = average + 1/4 difference.

Table 13b. Channel 2 Difference Limiter Bits (T2LIMIT[2:0])

D14	D13	D12	CHANNEL 2 DIFFERENCE LIMITER
0	0	0	No limiting is applied.
0	0	1	Difference is limited to 1 LSB (1/8 of a degree).
0	1	0	Difference is limited to 3 LSBs (3/8 of a degree).
0	1	1	Difference is limited to 7 LSBs (7/8 of a degree).
1	0	0	Difference is limited to 15 LSBs (1 7/8 degrees).
1	0	1	Difference is limited to 31 LSBs (3 7/8 degrees).
1	1	0	Difference is limited to 63 LSBs (7 7/8 degrees).
1	1	1	Difference is limited to 127 LSBs (15 7/8 degrees).

Table 13c. APC Parameter Source Select Bits (APCSRC_1, APCSRC_0)

APCSRC_1	APCSRC_0	APC PARAMETER SOURCE SELECT
0	0	Value stored in APC parameter register.
0	1	Reserved. Do not use.
1	0	Drain current samples.
1	1	External input samples (AIN input).

The A_HIST register bits A_HIST[3:0] set the APC hysteresis limits for both channel 1 and channel 2 VGATE_ calculations. After a new APC sample, the device proceeds in performing a VGATE_ calculation if that sample differs from the previous sample used for a VGATE_ calculation by an amount greater than the hysteresis setting (see Table 16e). Set APCCOMP_ and TCOMP_ to 0 before A_HIST is changed.

DAC Input Registers (IDAC1, IDAC2) (Write Only)

DAC_[11:0] set the value of the DAC Input registers (see Table 17). Bits D[15:12] are don't-care bits. The GATE_ output is not updated with this value until it is transferred to the DAC Output register. Write to the Load DAC register to transfer the contents of the DAC Input register to the DAC Output register. Write directly to the DAC Input register to manipulate the DAC output without triggering a VGATE_ calculation.

DAC Input and Output Registers (IODAC1, IODAC2) (Write Only)

DAC_[11:0] set the values of the input and output registers of the respective DACs (see Table 18). Writing to

this register does not trigger a VGATE_ calculation, but the GATE_ output is immediately updated with the value that is written to this register. Bits D[15:12] are don't-care bits. The contents of the DAC Input and Output registers are not stored in the EEPROM.

PGA Calibration Control Register (PGACAL) (Write Only)

The PGA Calibration Control register selects the PGA calibration mode and controls when calibrations occur (see Table 19). Bits D[15:3] are don't-care bits. The data contained in the PGA Calibration Control register is stored in the EEPROM.

Set TRACK to 0 to perform the next PGA calibration in acquisition mode, and set TRACK to 1 to perform the next PGA calibration in tracking mode. Leave TRACK set to 0 the first time a PGA calibration is performed after power-up.

Set DOCAL to 1 to perform calibrations of PGA1 and PGA2. DOCAL resets to 0 after the PGA calibration routine is complete. If either channel is powered down, the PGA calibration for that channel is bypassed.

Dual RF LDMOS Bias Controller with Nonvolatile Memory

Table 13d. VGATE_ Calculation Trigger Condition

SOFTWARE CONFIGURATION SETTINGS	VGATE_ CALCULATION TRIGGER CONDITIONS
TCOMP_ = 1 APCCOMP_ = 1 APCSRC_1 = 0 APCSRC_0 = 0	<ul style="list-style-type: none"> • Temperature measurements vary enough to exceed the hysteresis settings • A write command to the APC_ Parameter register • A write command to the VSET register through the serial interface
TCOMP_ = 1 APCCOMP_ = 1 APCSRC_1 = 1 APCSRC_0 = X	<ul style="list-style-type: none"> • Temperature measurements vary enough to exceed the hysteresis settings • Current-sense measurements or ADCIN_ samples vary enough to cause a new LUT value to be retrieved (depends on PSIZE and INT values in the LUT Configuration registers) • A write command to the VSET register through the serial interface
TCOMP_ = 1 APCCOMP_ = 0 APCSRC_1 = X APCSRC_0 = X	<ul style="list-style-type: none"> • Temperature measurements vary enough to exceed the hysteresis settings • A write command to the VSET register through the serial interface
TCOMP = 0 APCCOMP = 1 APCSRC_1 = 0 APCSRC_0 = 0	<ul style="list-style-type: none"> • A write command to the APC_ register through the serial interface • A write command to the VSET register through the serial interface
TCOMP = 0 APCCOMP = 1 APCSRC_1 = 1 APCSRC_0 = X	<ul style="list-style-type: none"> • Current-sense measurements vary enough to exceed the hysteresis settings • A write command to the VSET register through the serial interface
TCOMP = 0 APCCOMP = 0 APCSRC_1 = X APCSRC_0 = X	<ul style="list-style-type: none"> • A write command to the VSET register through the serial interface

X = Don't care.

Set SELFTIME to 1 and DOCAL to 1 to perform calibrations of PGA1 and PGA2 on a self-timed periodic basis (approximately every 13ms). When SELFTIME is set to 0, writing to PGACAL with DOCAL set to 1 manually triggers PGA calibration.

ADC Conversion Register (ADCCON) (Write Only)

Write to the ADC Conversion register to select which channels are converted and to set the ADC for continuous conversion of each selected channel (see Table 20). Set CONCONV to 1 to configure the ADC to perform continuous conversions of the selected channels.

Bits D[6:0] select which channels are converted. Select which channel is to be converted by setting the corresponding bit to 1. Any channel that is set to 0 will not be converted. Depending on the ADC clock mode that is selected in the Hardware Configuration register (see the *Internally Timed Acquisitions and Conversions* section and Table 11), writing to the ADC Conversion register initiates an ADC conversion of the selected channel or the next selected channel in the sequence if more than one channel is selected (see the *ADC Conversion Scheduling* section). Bits D[15:8] are don't-care bits.

Dual RF LDMOS Bias Controller with Nonvolatile Memory

Table 14. Alarm Hardware Configuration Register

DATA BITS	BIT NAME	RESET STATE	FUNCTION
D[15:11]	Unused	XXXXX	Unused bits.
D10*	AVGMON	0	ADC average monitor enable bit. Set AVGMON to 1 to average the ADC sample. The ADC average is written to the FIFO. The tracking average has a unique channel tag and is distinguishable from the raw sample. The average monitoring is automatically suspended when in LUT streaming and message modes. ADCMON and AVGMON cannot be active at the same time.
D9	INTEMP2	0	Channel 2 temperature alarm select bit. Set to 1 to configure the channel 2 temperature alarm to monitor the internal temperature sensor instead of the external temperature sensor. The status of the alarm is indicated by the channel 2 temperature flags in the flag register. The current-sense alarm for channel 2 is no longer available in this mode.
D8	ALMCOMP	0	ALARM comparator enable bit. Set to 1 to configure the ALARM output for comparator mode. Set to 0 to configure the ALARM output for interrupt mode.
D[7:6]	ALMHYST[1:0]	00	ALARM hysteresis select bits. See Table 14a.
D[5:4]	ALMCLMP2[1:0]	00	Channel 2 clamp-mode select bits. See Table 14b.
D[3:2]	ALMCLMP1[1:0]	00	Channel 1 clamp-mode select bits. See Table 14b.
D1	ALMPOL	0	ALARM polarity select bit. Set to 1 to configure the ALARM output to be active-low. Set to 0 for active-high.
D0	ALMOPEN	0	ALARM output configuration select bit. Set to 1 for open-drain ALARM output. Set to 0 for push-pull ALARM output.

X = Don't care.

*Write-only.

Table 14a. ALARM Hysteresis Select Bits (ALMHYST[1:0])

ALMHYST1	ALMHYST0	ALARM HYSTERESIS SELECT
0	0	8 LSBs of hysteresis (+1°C)
0	1	16 LSBs of hysteresis (+2°C)
1	0	32 LSBs of hysteresis (+4°C)
1	1	64 LSBs of hysteresis (+8°C)

Software Shutdown Register (SSHUT) (Write Only)

Write to the Software Shutdown register to power down the MAX11008 or specific sections of the MAX11008 to optimize power consumption (see Table 21). Bits D[15:6] are don't-care bits.

Set FULLPD to 1 to power down all sections of the MAX11008 except for the serial interface. FULLPD takes precedence over all of the other power-down bits. Any commands (other than writing to the Software Shutdown register) sent to the MAX11008 while in full power-down mode are ignored. Set FULLPD to 0 to exit full power-down mode.

Set FBGON to 1 to force the internal voltage reference to remain powered up. This optimizes ADC conversion times since the internal voltage reference does not automatically power down in between conversions (power-up time for internal reference is typically 50µs), but it also increases the power dissipation of the MAX11008. Set FBGON to 0 to power the internal voltage reference on and off as required by the ADC.

Set WDGPD to 1 to power down the internal watchdog oscillator. The watchdog oscillator monitors the internal circuit's operation. It is not accessible outside of the MAX11008. Power down the internal watchdog oscillator when entering LUS streaming mode.

Dual RF LDMOS Bias Controller with Nonvolatile Memory

Table 14b. Clamp-Mode Select Bits (ALMCLMP[1:0])

ALMCLMP1	ALMCLMP0	CLAMP MODE	ALARM CLAMP SELECT
0	0	Alarm report	If an alarm is triggered by a current or temperature conversion, the ALARM bit is set (1) in the alarm Flag register. No further action is taken.
0	1	Clamp gate	The GATE_ output clamps to AGND immediately, independent of alarms.
1	0	Clamp gate on alarm with clear	The GATE_ output is clamped to AGND in response to any alarm trip on the corresponding channel. A subsequent ADC conversion, which shows the alarm condition has been removed, clears the clamp condition automatically.
1	1	Clamp gate on alarm without clear	The GATE_ output is clamped to AGND in response to any alarm trip on the corresponding channel. The clamp does not clear automatically. If an alarm is triggered, the 11 value is overwritten to 01, causing a permanent clamp condition. A subsequent write to rest ALMCLMP[1:0] to 11 clears the clamp condition.

Table 15. VSET Registers

DATA BITS	BIT NAME	RESET STATE	FUNCTION
D[15:12]	Unused	0000	Unused bits.
D[11:0]	VSET_[11:0]	NA	VSET_ bits.

NA = Not applicable.

Set OSCPD to 1 to power down the internal oscillator. When the internal oscillator is powered down, all internal operations of the MAX11008 are suspended. OSCPD automatically resets back to 0 when the next command is received by the serial interface.

Powering down the oscillator and leaving the watchdog oscillator powered up may allow the watchdog timer to overflow. The overflow of the watchdog timer forces the MAX11008 to reset, reinitialize, and transmit a pulse on the ALARM output.

Set DAC_PD to 1 to power down DAC_ and PGA_. Values can still be written to the DAC Input and Output registers when DAC_ is powered down.

Load DAC Register (LDAC) (Write Only)

Write to the Load DAC register to transfer the contents of the DAC input registers to the DAC output registers (see Table 22). The Load DAC register is a write-only register that executes when written to, but does not have storage. This function facilitates the simultaneous update of both DAC outputs. Set LDDACCH1 to 1 to

transfer the contents of the DAC1 Input register to the DAC1 Output register. Set LDDACCH2 to 1 to transfer the contents of the DAC2 Input register to the DAC2 Output register. Bits D[15:2] are don't-care bits.

Message Register (MR) (Write Only)

Write to the Message register to place the MAX11008 into message mode (see the *Message Mode* section and Table 23). MSGL[7:0] specifies the number of data words (each data word is 16 bits long) to be read from the EEPROM. The message read from the EEPROM is between 1 and 256 words long. Write MSGL = 0 (decimal) to request a message length of 1, MSGL = 255 (decimal) to request a message length of 256. MSGA[7:0] specifies the starting address of the message to be read from the EEPROM.

FIFO Register (FIFO) (Read/Write)

When in message mode or ADC monitoring mode, the FIFO register is a read-only register (see Table 24). In message mode, the specified EEPROM data words (each data word is 16 bits long) are copied into the

Dual RF LDMOS Bias Controller with Nonvolatile Memory

FIFO (see the *Message Mode* section) so that the data words can be read out through the serial interface. In message mode the FIFO is eight deep, and does not overflow.

In ADC/average monitoring mode, the 12-bit ADC conversion results of each selected channel are copied into the FIFO so that the conversion results can be read out through the serial interface (see the *ADC Monitoring Mode* section). Each conversion result includes a 4-bit channel tag that indicates the source of the conversion (see Table 24a). In ADC/average monitoring mode the

FIFO is seven deep, and always contains the most recent seven data items. The oldest data placed into the FIFO is always read out first.

When in LUT streaming mode, the FIFO register is a write-only register. In LUT streaming mode, write the data word that is to be written to the EEPROM into the FIFO register (see the *LUT Streaming Mode* section). In this mode the FIFO is eight deep, and is prevented from overflow. Data written to the FIFO when it is full is ignored.

Table 16a. APC Parameter Register (Valid when APCSRC[1:0] = 00)

DATA BITS	BIT NAME	RESET STATE	FUNCTION
D[15:12]	T_HIST[3:0]	0000	Hysteresis limit bits. The T_HIST[3:0] bits set the temperature hysteresis limits for both channel 1 and channel 2 for VGATE_ calculations. See Table 14a.
D[11:0]	APC[11:0]	NA	APC parameter bits.

NA = Not applicable.

Table 16b. APC Parameter Register (Valid when APCSRC[1:0] = 10 or 11)

DATA BITS	BIT NAME	RESET STATE	FUNCTION
D[15:12]	T_HIST[3:0]	0	Temperature hysteresis limit bits. The T_HIST[3:0] bits set the temperature hysteresis limits for both channel 1 and channel 2 for VGATE_ calculations. See Table 16c. Set APCCOMP_ and TCOMP_ to 0 before T_HIST is changed.
D[11:8]	Unused	NA	—
D7	A_AVGCTL	0	APC parameter bit. Controls the averaging equation for channel 1 and channel 2. Set A_AVGCTL to 0 for average plus 1/16 difference. Set A_AVGCTL to 1 for average plus 1/4 difference.
D[6:4]	A_LIMIT[2:0]	0	APC difference limiter bits. Set A_LIMIT[2:0] to enable the difference limiter for channel 1 and channel 2 APC averaging. See Table 16d.
D[3:0]	A_HIST[3:0]	0	APC hysteresis limit bits. The A_HIST[3:0] bits set the APC hysteresis limits for both channel 1 and channel 2 for VGATE_ calculations. See Table 16e. Set APCCOMP_ and TCOMP_ to 0 before A_HIST is changed.

Dual RF LDMOS Bias Controller with Nonvolatile Memory

MAX11008

Table 16c. Temperature Hysteresis Limit Register Bits

TxHIST[3:0]	FUNCTION
0000	1 LSB (1/8 of a degree). I.e., no hysteresis
0001	2 LSBs (1/4 of a degree)
0010	3 LSBs (3/8 of a degree)
0011	4 LSBs (1/2 of a degree)
0100	5 LSBs (5/8 of a degree)
0101	6 LSBs (3/4 of a degree)
0110	7 LSBs (7/8 of a degree)
0111	8 LSBs (1 degree)
1000	9 LSBs (1 1/8 of a degree)
1001	10 LSBs (1 1/4 of a degree)
1010	11 LSBs (1 3/8 of a degree)
1011	12 LSBs (1 1/2 of a degree)
1100	13 LSBs (1 5/8 of a degree)
1101	14 LSBs (1 3/4 of a degree)
1110	15 LSBs (1 7/8 of a degree)
1111	16 LSBs (2 degrees)

Table 16e. APC Hysteresis Limit Register Bits

AxHIST[3:0]	FUNCTION
0000	1 LSB. I.e., no hysteresis
0001	2 LSBs
0010	3 LSBs
0011	4 LSBs
0100	5 LSBs
0101	6 LSBs
0110	7 LSBs
0111	8 LSBs
1000	9 LSBs
1001	10 LSBs
1010	11 LSBs
1011	12 LSBs
1100	13 LSBs
1101	14 LSBs
1110	15 LSBs
1111	16 LSBs

Table 16d. APC Difference Limiter for Averaging

A_LIMIT[2:0]	FUNCTION
000	No limiting is applied
001	Difference is limited to 1 LSB (1/8 of a degree)
010	Difference is limited to 3 LSBs (3/8 of a degree)
011	Difference is limited to 7 LSBs (7/8 of a degree)
100	Difference is limited to 15 LSBs (1 7/8 degrees)
101	Difference is limited to 31 LSBs (3 7/8 degrees)
110	Difference is limited to 63 LSBs (7 7/8 degrees)
111	Difference is limited to 127 LSBs (15 7/8 degrees)

Dual RF LDMOS Bias Controller with Nonvolatile Memory

Software Clear Register (SCLR) (Write Only)

Write to the Software Clear register to clear the internal registers with a single write command (see Table 25). Bits D[15:7] are don't-care bits.

FULLRST and ARMRST operate in conjunction with each other to allow a full hardware reset of the device. If ARMRST has been set to 1 by a previous write command, setting FULLRST to 1 initiates a full reset of the MAX11008. ARMRST can only be set to 1 when the FULLRST is set to 0 in the same data word. This provides protection from accidental resets since two write commands are needed to initiate a full reset. To perform a full reset, first write a data word with FULLRST set to 0 and ARMRST set to 1. Then write another data word with FULLRST set to 1 and ARMRST set to 0.

Set the ALMSCLR bit to 1 to clear all alarm threshold registers and their respective flags in the Flag register.

Set the AVGCLR bit to 1 to clear the average and hysteresis memory for all lookup operations. Setting the AVGCLR bit reacquires the average and performs a new LUT operation.

Set FIFOCLEAR to 1 to clear the FIFO. This function is instantaneous and does not affect BUSY.

Set DAC_RST to 1 to clear the contents of the DAC Input and Output registers. This function is instantaneous and does not affect BUSY.

Flag Register (FLAG) (Read Only)

The Flag register indicates if the MAX11008 is currently in the middle of an internal calculation, if a full reset has been performed, and the status of the FIFO. The Flag register also indicates the source of an alarm when an alarm threshold is exceeded (see Table 26). Bits D[15:12] are don't-care bits.

ALUBUSY is set to 1 when the MAX11008 is performing an internal calculation (see the *Busy Output* section) and returns to 0 when the calculation is complete.

RESTART is set to 1 if a full reset or watchdog initiated reset was performed (see the *Software Clear Register (SCLR) (Write Only)* section) and returns to 0 after the Flag register is read. RESTART is initially set to 0 when power is first applied (a power-on reset condition).

Table 17. DAC Input Registers

DATA BITS	BIT NAME	RESET STATE	FUNCTION
D[15:12]	Unused	XXXX	Unused bits.
D[11:0]	DACIP_[11:0]	NA	DAC Input register data bits.

X = Don't care.

NA = Not applicable.

Table 18. DAC Input and Output Register

DATA BITS	BIT NAME	RESET STATE	FUNCTION
D[15:12]	Unused	X	Unused bits.
D[11:0]	DAC_[11:0]	NA	DAC Input and Output register data bits.

X = Don't care.

NA = Not applicable.

Dual RF LDMOS Bias Controller with Nonvolatile Memory

FIFOEMP is set to 1 when the FIFO is empty. Once data is placed into the FIFO, FIFOEMP is set to 0.

When in ADC monitoring mode, FIFOOVER is set to 1 when a FIFO overflow occurs. FIFOOVER remains at 1, even if the FIFO is subsequently read and no longer full. FIFOOVER is reset by reading the Flag register. When in LUT streaming mode or message mode, the FIFO is not permitted to overflow and FIFOOVER then denotes when the FIFO is full. FIFOOVER is set to 1

when the FIFO is full and immediately returns to 0 once a data word is moved out of the FIFO.

HIGHI₁ is set to 1 when the individual channel 1 and channel 2 current-sense measurements exceed the individual channel 1 and channel 2 high current threshold and returns to 0 after the Flag register is read. HIGHI₂ is replaced by HIGHT₂ when the INTEMP₂ bit is set in the Alarm Hardware Configuration register.

Table 19. PGA Calibration Control Register

DATA BITS	BIT NAME	RESET STATE	FUNCTION
D[15:3]	Unused	X	Unused bits.
D2	TRACK	0	Acquisition/tracking bit. Set to 0 to force the next current-sense calibration to run in acquisition mode. Set to 1 to force the next calibration to run in tracking mode. Set TRACK to 0 the first time through a calibration.
D1	DOCAL	0	Single calibration select bit. Set to 1 perform single or self-timed calibrations of PGA1 and PGA2. DOCAL resets to 0 after calibration.
D0	SELFTIME	0	Self-timed calibration select bit. Set to 1 to perform calibrations of PGA1 and PGA2 on a self-timed periodic basis (approximately every 13ms). When set to 0, calibrations only occur when DOCAL is set to 1.

X = Don't care.

NA = Not applicable.

Table 20. ADC Conversion Register

DATA BITS	BIT NAME	RESET STATE	FUNCTION
D[15:8]	Unused	X	Unused bits.
D7	CONCONV	0	Continuous conversion select bit. Set to 1 to perform continuous conversions of the selected channels.
D6	ADCIN2	0	ADCIN2 conversion select bit.
D5	CS2	0	CS2 current-sense conversion select bit.
D4	EXTEMP2	0	External temperature sensor 2 conversion select bit.
D3	ADCIN1	0	ADCIN1 conversion select bit.
D2	CS1	0	CS1 current-sense conversion select bit.
D1	EXTEMP1	0	External temperature sensor 1 conversion select bit.
D0	INTEMP	0	Internal temperature sensor conversion select bit.

X = Don't care.

NA = Not applicable.

Dual RF LDMOS Bias Controller with Nonvolatile Memory

LOWI_ is set to 1 when the individual channel 1 and channel 2 current-sense measurements exceed the individual channel 1 and channel 2 low current threshold and returns to 0 after the Flag register is read. LOWI2 is replaced by LOWT2 when the INTEMP2 bit is set in the Alarm Hardware Configuration register.

HIGHT_ is set to 1 when the individual channel 1 and channel 2 temperature measurements exceed the individual channel 1 and channel 2 high temperature threshold and returns to 0 after the Flag register is read. HIGHT2 is unused when the INTEMP2 bit is set in the Alarm Hardware Configuration register. When INTEMP2 is set, HIGHT2 returns a 1 or 0.

LOWT_ is set to 1 when the individual channel 1 and channel 2 temperature measurements exceed the individual channel 1 and channel 2 low temperature threshold and returns to 0 after the Flag register is read. LOWT2 is unused when the INTEMP2 bit is set in the Alarm Hardware Configuration register. When INTEMP2 is set, LOWT2 returns a 1 or 0.

LUT Streaming Register (LUTSTRM) (Write Only)

Write to the LUT Streaming register to place the MAX11008 into LUT streaming mode (see the *LUT Streaming Mode* section and Table 27).

Bits LUTSL[7:0] specify the number of data words (each data word is 16 bits long) that are to be written to the EEPROM. The minimum and maximum number of data words that can be written to the EEPROM are 1 and 256, respectively. Setting LUTSL[7:0] to 0 instructs the MAX11008 to expect a LUT of length 1. Setting

LUTSL[7:0] to 255 instructs the MAX11008 to expect a LUT of length 256.

Bits LUTSA[7:0] specify the starting address of the data that is to be written to the EEPROM. The MAX11008 counts the number of words that are written to the FIFO. The device remains in LUT streaming mode until all the indicated words are received.

Applications Information

External Temperature Sensor Considerations

To optimize the performance of the temperature sensors, place the MAX11008 as close as possible to the remote diodes. Traces of DXP_ and DXN_ should not be routed across noisy digital lines and buses. Minimize the noise that is coupled into the DXP_ and DXN_ traces by shielding them with ground traces on each side of the pair of temperature sensor traces (see Figure 23). Routing the DXP_ and DXN_ traces over the analog ground plane (AGND) also helps minimize noise. Use wide traces (10 mils or wider) to minimize the trace inductance of the DXP_ and DXN_ traces.

Layout, Grounding, and Bypassing

Ensure that digital and analog signal lines are separated from each other. Use separate ground planes for AGND and DGND. Connect both ground planes to a single point on the PCB (star ground point). Do not run analog and digital signals parallel to one another (especially clock signals), and do not run digital lines underneath the MAX11008 package. High-frequency noise in the AVDD power supply may affect performance.

Table 21. Software Shutdown Register

DATA BITS	BIT NAME	RESET STATE	FUNCTION
D[15:6]	Unused	X	Unused bits.
D5	FULLPD	0	Full power-down bit. Set to 1 to power down all sections of the MAX11008. Set to 0 to exit full power-down mode.
D4	FBGON	0	Reference power-on bit. Set to 1 to force internal voltage reference to remain on at all times (except when FULLPD is set to 1). Set to 0 to only power internal reference when an ADC conversion is performed.
D3	WDGPD	0	Watchdog oscillator power-down bit. Set to 1 to power down internal watchdog oscillator.
D2	OSCPD	0	Internal oscillator power-down bit. Set to 1 to power down internal oscillator.
D1	DAC2PD	1	Channel 2 DAC power-down bit. Set to 1 to power down DAC2 and PGA2.
D0	DAC1PD	1	Channel 1 DAC power-down bit. Set to 1 to power down DAC1 and PGA1.

X = Don't care.

Dual RF LDMOS Bias Controller with Nonvolatile Memory

Bypass the AV_{DD} supply with a 0.1μF capacitor to AGND, and place the capacitor as physically close as possible to the AV_{DD} input. Bypass the DV_{DD} supply with a 0.1μF capacitor to DGND, and place the capacitor

as physically close as possible to the DV_{DD} input. If the power supply is very noisy, connect a 10Ω resistor in series with the supply input to improve power-supply filtering.

Table 22. Load DAC Register

DATA BITS	BIT NAME	RESET STATE	FUNCTION
D[15:2]	Unused	X	Unused bits.
D1	LDDACCH2	NA	Channel 2 load DAC bit. Set to 1 to transfer DAC2 input register contents to DAC2 output register.
D0	LDDACCH1	NA	Channel 1 load DAC bit. Set to 1 to transfer DAC1 input register contents to DAC1 output register.

X = Don't care.

NA = Not applicable.

Table 23. Message Register

DATA BITS	BIT NAME	RESET STATE	FUNCTION
D[15:8]	MSGL[7:0]	0000 0000	Message length bits. Specifies the length of the message to be read from the EEPROM in words. The actual length read is MSGL + 1.
D[7:0]	MSGA[7:0]	0000 0000	Message address bits. Specifies the starting address of the message to be read from the EEPROM.

Table 24. FIFO Read Register

DATA BITS	BIT NAME	RESET STATE	FUNCTION
D[15:12]	DATA[15:12]/TAG[3:0]	0000	Message mode data bits/LUT streaming mode data bits/ADC channel tag bits. See Table 24a.
D[11:0]	DATA[11:0]	0000 0000 0000	Message data bits/ADC data bits.

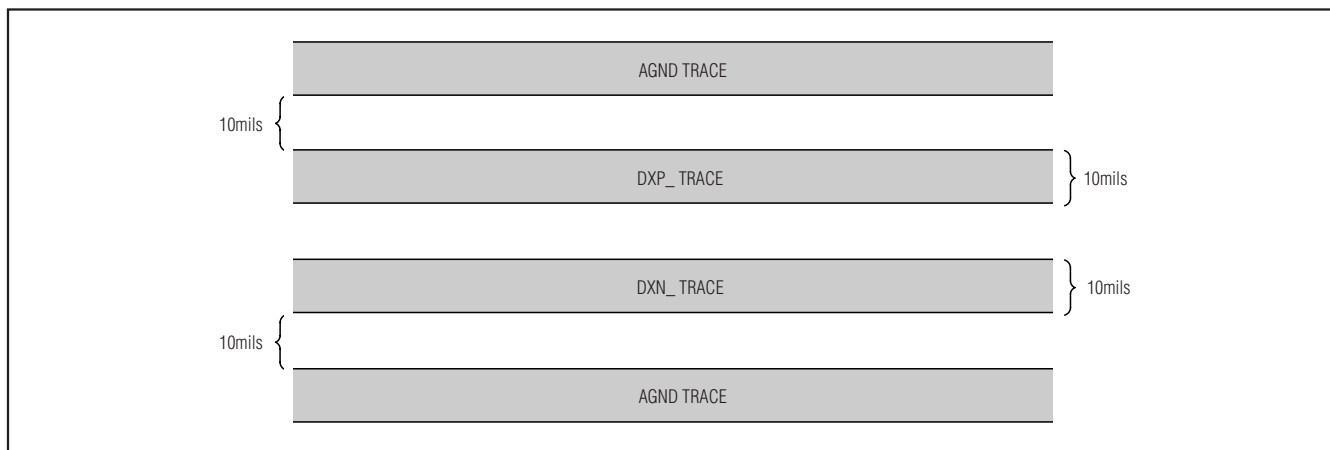

Figure 23. Recommended DXP_ and DXN_ PCB Trace Layout

Dual RF LDMOS Bias Controller with Nonvolatile Memory

Table 24a. FIFO Read Channel Tags (TAG[3:0])

CHANNEL TAGS				ADC DATA DESCRIPTION
TAG3	TAG2	TAG1	TAG0	
0	0	0	0	Internal temperature sensor measurement. ADCMON bit must be set.
0	0	0	1	Channel 1 external temperature measurement. ADCMON bit must be set.
0	0	1	0	Channel 1 drain current measurement. ADCMON bit must be set.
0	0	1	1	ADCIN1 input measurement. ADCMON bit must be set.
0	1	0	0	Channel 2 external temperature measurement. ADCMON bit must be set.
0	1	0	1	Channel 2 drain current measurement. ADCMON bit must be set.
0	1	1	0	ADCIN2 input measurement. ADCMON bit must be set.
1	0	0	0	Channel 1 temperature average. AVGMON bit must be set.
1	0	0	1	Channel 1 APC average. AVGMON bit must be set.
1	0	1	0	Channel 2 temperature average. AVGMON bit must be set.
1	0	1	1	Channel 2 APC average. AVGMON bit must be set.
1	1	1	0	Error tag. Indicates data may be corrupted.
1	1	1	1	Empty FIFO tag. This tag appears during a FIFO read if the FIFO is empty at the time the read command is made. In addition to this channel tag, the current value of the Flag register is provided in place of the ADC data.

Table 25. Software Clear Register

DATA BITS	BIT NAME	RESET STATE	FUNCTION
D[15:7]	Unused	X	Unused bits.
D6	FULLRST	NA	Full reset bit. If ARMRST has been set to 1 in a previous write operation, set FULLRST to 1 to perform a full reset. Otherwise, a full reset will not be performed and the value of FULLRST remains unchanged.
D5	ARMRST	0	Full reset enable bit. Set to 1 at the same time FULLRST is set to 0 to enable full reset capabilities.
D4	ALMSCLR	NA	Alarm threshold registers reset bit. Set to 1 to clear all alarm threshold registers and their respective flags in the Flag register.
D3	AVGCLR	NA	Average clear enable bit. Set the AVGCLR bit to 1 to clear the average and hysteresis memory for all lookup operations.
D2	FIFOCLR	NA	FIFO clear bit. Set to 1 to clear the FIFO.
D1	DAC2RST	NA	DAC 2 reset bit. Set to 1 to clear DAC2 input and output registers.
D0	DAC1RST	NA	DAC 1 reset bit. Set to 1 to clear DAC1 input and output registers.

X = Don't care.

NA = Not applicable.

Dual RF LDMOS Bias Controller with Nonvolatile Memory

Table 26. Flag Register

DATA BITS	BIT NAME	RESET STATE	FUNCTION
D[15:12]	Reserved	X	Reserved bits.
D11	ALUBUSY	1	ALU busy bit. Set to 1 when the MAX11008 is performing internal calculations. Set to 0 after calculations are complete.
D10	RESTART	0	Restart flag bit. Set to 1 after a full software reset is performed. Returns to 0 after the Flag register is read. Set to 0 after initial power-up.
D9	FIFOEMP	0	FIFO empty flag bit. Set to 1 when FIFO is empty. Set to 0 when data is placed into the FIFO.
D8	FIFOOVER	0	FIFO overflow/full flag bit. Set to 1 when in ADC monitoring mode and FIFO overflow occurs. Returns to 0 when after Flag register is read. Set to 1 when in LUT streaming mode and the FIFO is full. Returns to 0 after a data word is moved out of the FIFO.
D7	HIGHI2	0	Channel 2 high current flag bit. Set to 1 when the channel 2 current-sense measurement exceeds the channel 2 high current threshold and returns to 0 after the Flag register is read. When the INTEMP2 bit is set, this bit functions as the internal temperature sensor's alarm status.
D6	LOWI2	0	Channel 2 low current flag bit. Set to 1 when the channel 2 current-sense measurement exceeds the channel 2 low current threshold and returns to 0 after the Flag register is read. When the INTEMP2 bit is set, this bit functions as the internal temperature sensor's alarm status.
D5	HIGHT2	0	Channel 2 high temperature flag bit. Set to 1 when the channel 2 temperature measurement exceeds the channel 2 high temperature threshold and returns to 0 after the Flag register is read. When the INTEMP2 bit is set, this bit is unused and may read as 1 or 0.
D4	LOWT2	0	Channel 2 low temperature flag bit. Set to 1 when the channel 2 temperature measurement exceeds the channel 2 low temperature threshold and returns to 0 after the Flag register is read. When the INTEMP2 bit is set, this bit is unused and may read as a 1 or 0.
D3	HIGHI1	0	Channel 1 high current flag bit. Set to 1 when the channel 1 current-sense measurement exceeds the channel 1 high current threshold and returns to 0 after the Flag register is read.
D2	LOWI1	0	Channel 1 low current flag bit. Set to 1 when the channel 1 current-sense measurement exceeds the channel 1 low current threshold and returns to 0 after the Flag register is read.
D1	HIGHT1	0	Channel 1 high temperature flag bit. Set to 1 when the channel 1 temperature measurement exceeds the channel 1 high temperature threshold and returns to 0 after the Flag register is read.
D0	LOWT1	0	Channel 1 low temperature flag bit. Set to 1 when the channel 1 temperature measurement exceeds the channel 1 low temperature threshold and returns to 0 after the Flag register is read.

X = Don't care.

Dual RF LDMOS Bias Controller with Nonvolatile Memory

Table 27. LUT Streaming Register

DATA BITS	BIT NAME	RESET STATE	FUNCTION
D[15:8]	LUTSL[7:0]	0	LUT length bits. Specifies the number of data words to be written to the EEPROM. Up to 256 data words can be written. The actual length written is LUTSL + 1.
D[7:0]	LUTSA[7:0]	0	LUT address bits. Specifies the starting address of the data to be written to the EEPROM.

Definitions

Integral Nonlinearity

Integral nonlinearity (INL) is the deviation of the values on an actual transfer function from a straight line. This straight line can be either a best-straight-line fit or a line drawn between the end points of the transfer function, once offset and gain errors have been nullified. INL for the MAX11008 is measured using the end-point method.

Differential Nonlinearity

Differential nonlinearity (DNL) is the difference between an actual step width and the ideal value of 1 LSB. A DNL error specification of greater than -1 LSB guarantees no missing codes and a monotonic transfer function.

ADC Offset Error

For an ideal converter, the first transition occurs at 0.5 LSB, above zero. Offset error is the amount of deviation between the measured first transition point and the ideal first transition point.

ADC Gain Error

When a positive full-scale voltage is applied to the converter inputs, the digital output is all ones (FFFh). The transition from FFEh to FFFh occurs at 1.5 LSB below full scale. Gain error is the amount of deviation between the measured full-scale transition point and the ideal full-scale transition point with the offset error removed.

Aperture Delay

Aperture delay (t_{AD}) is the time between the rising edge of the sampling clock and the instant when an actual sample is taken.

Signal-to-Noise Ratio

For a waveform perfectly reconstructed from digital samples, signal-to-noise ratio (SNR) is the ratio of full-scale analog input (RMS value) to the RMS quantization error (residual error). The ideal, theoretical minimum analog-to-digital noise is caused by quantization error

only and results directly from the ADC's resolution (N bits):

$$\text{SNR} = (6.02 \times N + 1.76)\text{dB}$$

In reality, there are other noise sources besides quantization noise, including thermal noise, reference noise, clock jitter, etc. Therefore, SNR is calculated by taking the ratio of the RMS signal to the RMS noise. RMS noise includes all spectral components to the Nyquist frequency excluding the fundamental, the first five harmonics, and the DC offset.

Signal-to-Noise Plus Distortion

Signal-to-noise plus distortion (SINAD) is the ratio of the fundamental input frequency's RMS amplitude to the RMS noise plus distortion. RMS noise plus distortion includes all spectral components to the Nyquist frequency excluding the fundamental and the DC offset:

$$\text{SINAD (dB)} = 20 \times \log(\text{Signal}_{\text{RMS}}/\text{Noise}_{\text{RMS}})$$

Effective Number of Bits

Effective number of bits (ENOB) indicates the global accuracy of an ADC at a specific input frequency and sampling rate. An ideal ADC's error consists of quantization noise only. With an input range equal to the full-scale range of the ADC, calculate the effective number of bits as follows:

$$\text{ENOB} = (\text{SINAD} - 1.76)/6.02$$

Total Harmonic Distortion

Total harmonic distortion (THD) is the ratio of the RMS sum of the first five harmonics of the input signal to the fundamental itself. This is expressed as:

$$\text{THD} = 20 \times \log\left(\frac{\sqrt{V_2^2 + V_3^2 + V_4^2 + V_5^2 + V_6^2}}{V_1}\right)$$

where V_1 is the fundamental amplitude, and V_2 through V_6 are the amplitudes of the first five harmonics.

Dual RF LDMOS Bias Controller with Nonvolatile Memory

Spurious-Free Dynamic Range

Spurious-free dynamic range (SFDR) is the ratio of the RMS amplitude of the fundamental (maximum signal component) to the RMS value of the next largest spectral component.

Intermodulation Distortion (IMD)

IMD is the total power of the intermodulation products relative to the total input power when two tones, f_1 and f_2 , are present at the inputs. The intermodulation products are $(f_1 \pm f_2)$, $(2 \times f_1)$, $(2 \times f_2)$, $(2 \times f_1 \pm f_2)$, $(2 \times f_2 \pm f_1)$. The individual input tone levels are at -7dB FS.

Full-Power Bandwidth

A large -0.5dB FS analog input signal is applied to an ADC, and the input frequency is swept up to the point where the amplitude of the digitized conversion result has decreased by -3dB. This point is defined as the full-power input bandwidth frequency.

Chip Information

PROCESS: BiCMOS

Package Information

For the latest package outline information and land patterns, go to www.maxim-ic.com/packages.

PACKAGE TYPE	PACKAGE CODE	DOCUMENT NO.
48 TQFN-EP	T4877M-1	21-0144

Pin Configuration

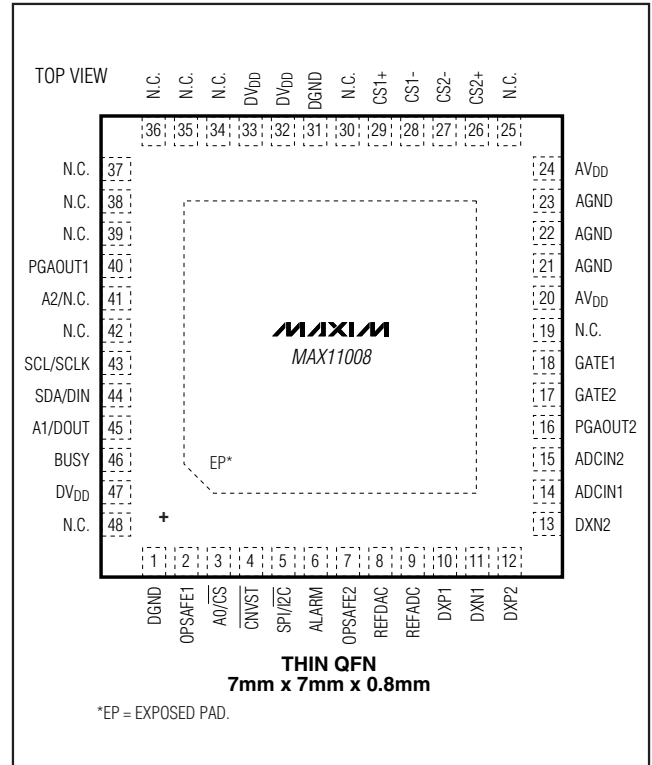

MAX11008

Maxim cannot assume responsibility for use of any circuitry other than circuitry entirely embodied in a Maxim product. No circuit patent licenses are implied. Maxim reserves the right to change the circuitry and specifications without notice at any time.

Maxim Integrated Products, 120 San Gabriel Drive, Sunnyvale, CA 94086 408-737-7600 67

Компания «Океан Электроники» предлагает заключение долгосрочных отношений при поставках импортных электронных компонентов на взаимовыгодных условиях!

Наши преимущества:

- Поставка оригинальных импортных электронных компонентов напрямую с производств Америки, Европы и Азии, а так же с крупнейших складов мира;
- Широкая линейка поставок активных и пассивных импортных электронных компонентов (более 30 млн. наименований);
- Поставка сложных, дефицитных, либо снятых с производства позиций;
- Оперативные сроки поставки под заказ (от 5 рабочих дней);
- Экспресс доставка в любую точку России;
- Помощь Конструкторского Отдела и консультации квалифицированных инженеров;
- Техническая поддержка проекта, помощь в подборе аналогов, поставка прототипов;
- Поставка электронных компонентов под контролем ВП;
- Система менеджмента качества сертифицирована по Международному стандарту ISO 9001;
- При необходимости вся продукция военного и аэрокосмического назначения проходит испытания и сертификацию в лаборатории (по согласованию с заказчиком);
- Поставка специализированных компонентов военного и аэрокосмического уровня качества (Xilinx, Altera, Analog Devices, Intersil, Interpoint, Microsemi, Actel, Aeroflex, Peregrine, VPT, Syfer, Eurofarad, Texas Instruments, MS Kennedy, Miteq, Cobham, E2V, MA-COM, Hittite, Mini-Circuits, General Dynamics и др.);

Компания «Океан Электроники» является официальным дистрибьютором и эксклюзивным представителем в России одного из крупнейших производителей разъемов военного и аэрокосмического назначения «JONHON», а так же официальным дистрибьютором и эксклюзивным представителем в России производителя высокотехнологичных и надежных решений для передачи СВЧ сигналов «FORSTAR».



JONHON

«JONHON» (основан в 1970 г.)

Разъемы специального, военного и аэрокосмического назначения:

(Применяются в военной, авиационной, аэрокосмической, морской, железнодорожной, горно- и нефтедобывающей отраслях промышленности)

«FORSTAR» (основан в 1998 г.)

ВЧ соединители, коаксиальные кабели, кабельные сборки и микроволновые компоненты:

(Применяются в телекоммуникациях гражданского и специального назначения, в средствах связи, РЛС, а так же военной, авиационной и аэрокосмической отраслях промышленности).



Телефон: 8 (812) 309-75-97 (многоканальный)

Факс: 8 (812) 320-03-32

Электронная почта: ocean@oceanchips.ru

Web: <http://oceanchips.ru/>

Адрес: 198099, г. Санкт-Петербург, ул. Калинина, д. 2, корп. 4, лит. А