

APA501

Series

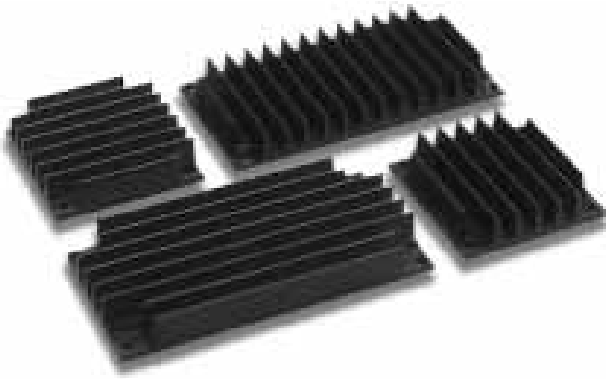

**Heatsinks for Power Modules
Technical Reference Manual**

Series Highlights

- Horizontal, Vertical and Low Profile fin options
- Full range of mounting accessories

Contents

Heatsinks	3
"60" Size Heatsink Dimensions & Characteristics	4
"80" Size Heatsink Dimensions & Characteristics	7
 Thermal Design Process and Example	 11

Heatsinks

Heatsinks for **AMPSS** modules are available in a variety of sizes and fin orientation. Mounting kits and thermal pads are also available. The table below shows the options available for "80" and "60" module sizes.

A heatsink mounting kit provides the most convenient way to mount the heatsink to the module and then mount the assembly onto a circuit board

AMPSS modules may be retained by their input and output pins only, or may be fixed to the board using bolts screwed into the tapped studs which are provided as part of the mounting kit. In both cases the studs provide clearance between the module and the circuit board to facilitate PCB cleaning operations.

Note: baseplate and heatsink must be connected to protective earth

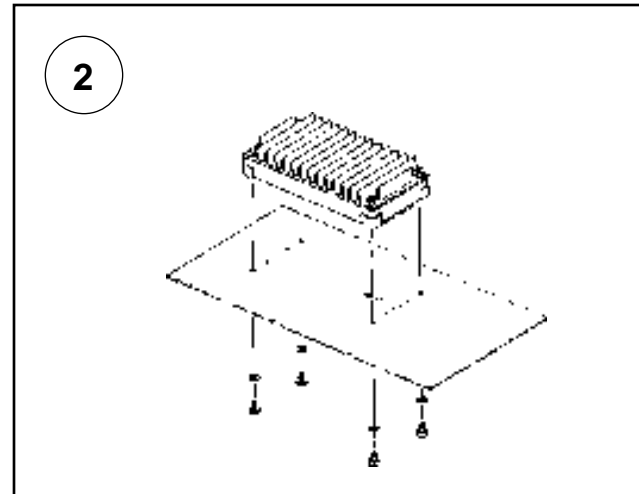

Description	Model Number	Dimensions		Free air thermal resistance
		inches	mm	
Heatsink, "60" size, vertical fin.	APA501-60-001	2.26x2.32x0.6	57.5x59x15	3.8°C/W
Heatsink, "60" size, horizontal fin	APA501-60-002	2.26x2.32x0.6	57.5x59x15	3.9°C/W
Heatsink, "60" size, vertical fin.	APA501-60-003	2.26x2.32x0.9	57.5x59x22.5	3.3°C/W
Heatsink, "60" size, horizontal fin	APA501-60-004	2.26x2.32x0.9	57.5x59x22.5	3.7°C/W
Heatsink, "60" size, vertical fin.	APA501-60-005	2.26x2.32x1.5	57.5x59x37	2.8°C/W
Heatsink, "60" size, horizontal fin	APA501-60-006	2.26x2.32x1.5	57.5x59x37	2.8°C/W
Heatsink, "60" size, low profile	APA501-60-007	2.25x3.50x0.5	57.2x89x12	3.6°C/W
Heatsink, "80" size, vertical fin.	APA501-80-001	4.53x2.32x0.6	115x59x15	2.7°C/W
Heatsink, "80" size, horizontal fin	APA501-80-002	4.53x2.32x0.6	115x59x15	2.4°C/W
Heatsink, "80" size, vertical fin.	APA501-80-003	4.53x2.32x0.9	115x59x22.5	2.2°C/W
Heatsink, "80" size, horizontal fin	APA501-80-004	4.53x2.32x0.9	115x59x22.5	2.0°C/W
Heatsink, "80" size, vertical fin.	APA501-80-005	4.53x2.32x1.5	115x59x37	2.0°C/W
Heatsink, "80" size, horizontal fin	APA501-80-006	4.53x2.32x1.5	115x59x37	1.7°C/W
Heatsink, "80" size, low profile	APA501-80-007	4.55x3.50x0.5	115.6x89x12	2.2°C/W
Thermal Pad, "60" size	APA502-60-001			
Thermal Pad, "80" size	APA502-80-001			
Mounting Kit, Tapped Studs	APA503-00-001			
Mounting Kit, Solder Studs	APA503-00-002			
Mounting Kit, Tapped Studs for low profile heatsink	APA503-00-007			
Mounting Kit, Solder Studs for low profile heatsink	APA503-00-008			
Spring Sockets (20 cont. 15pwr)	APA504-00-001			

"60" Size Heatsink Dimensions & Characteristics

APA501-60-001

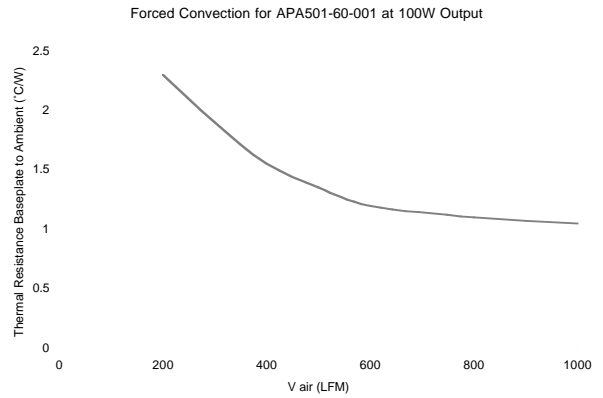
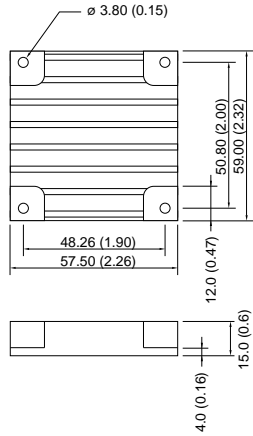

APA501-60-002

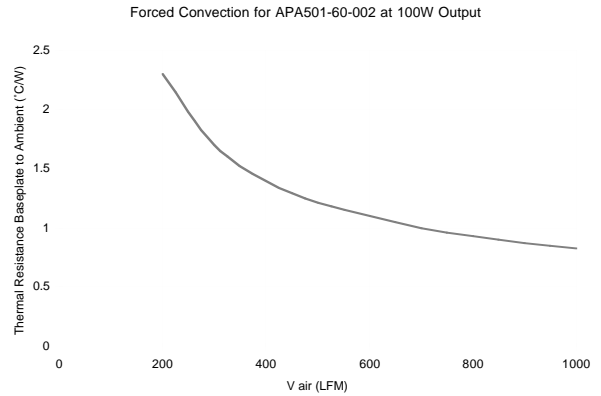
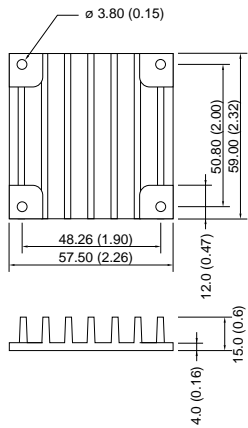

APA501-60-003

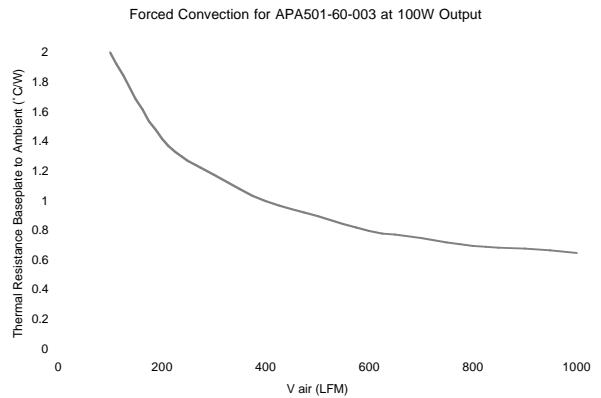
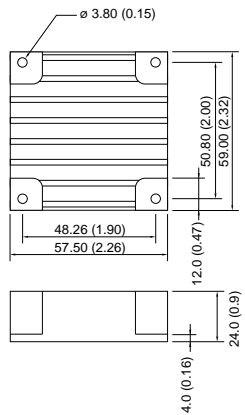

APA501-60-004

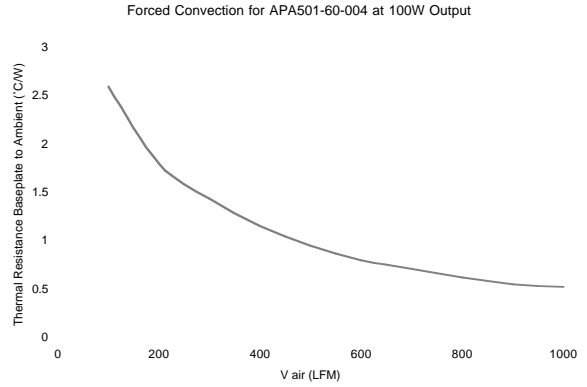

APA501-60-005

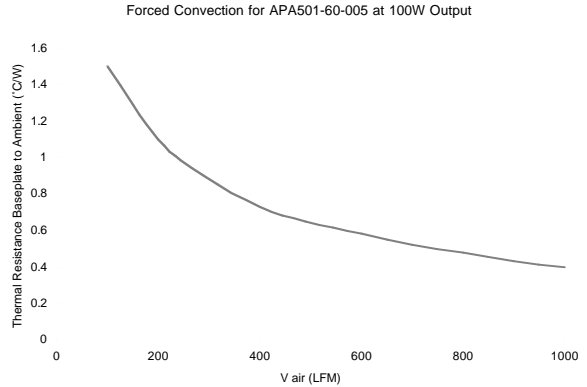
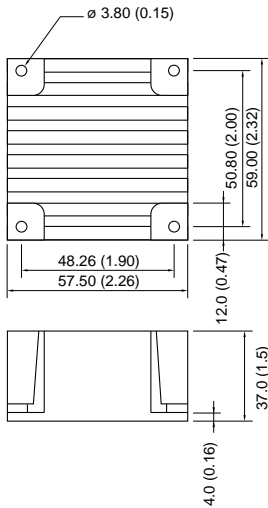

APA501-60-006

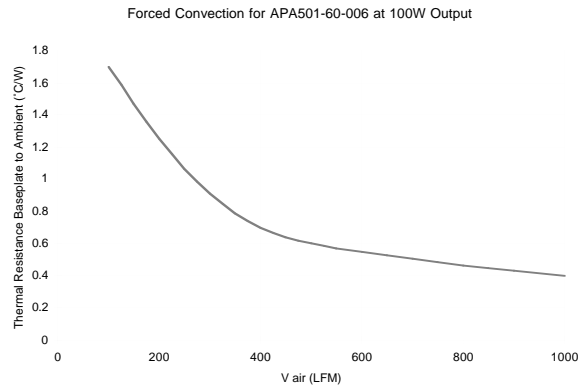
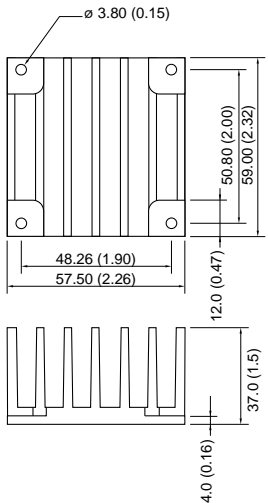

APA501-60-007

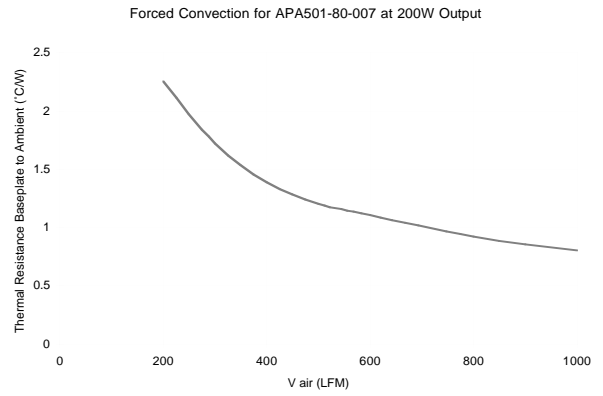

"80" Size Heatsink Dimensions & Characteristics

APA501-80-001

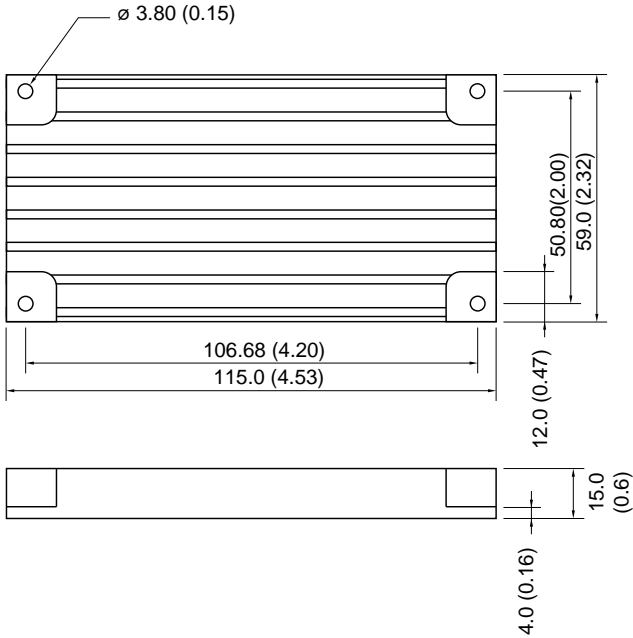

Forced Convection for APA501-80-001 at 200W Output

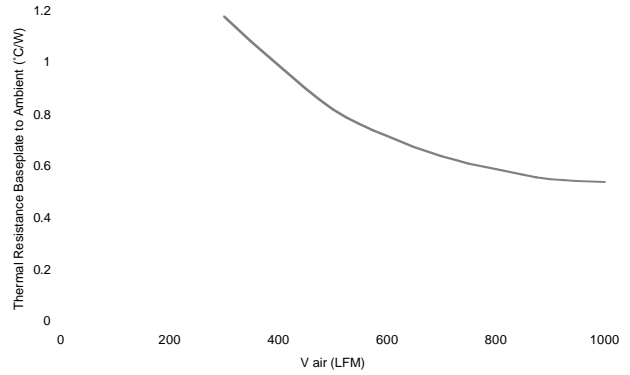

APA501-80-002

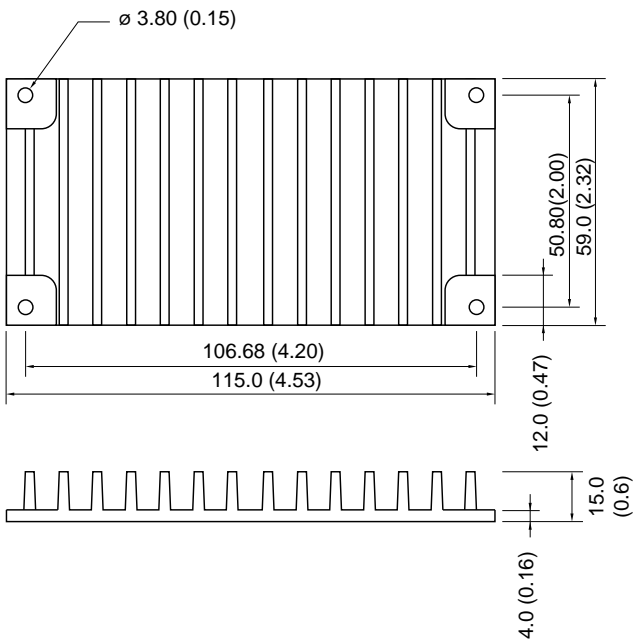

Forced Convection for APA501-80-002 at 200W Output

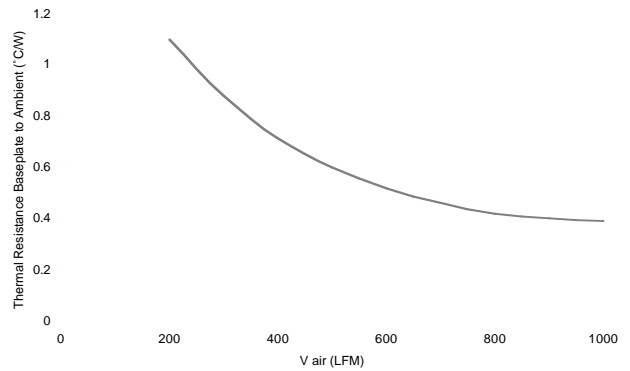

APA501-80-003



APA501-80-004

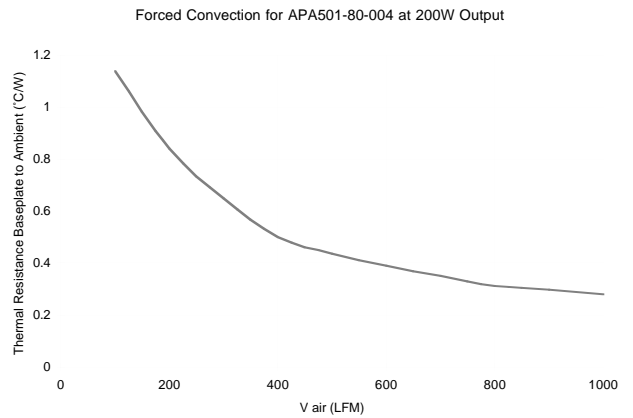

APA501-80-005



APA501-80-006

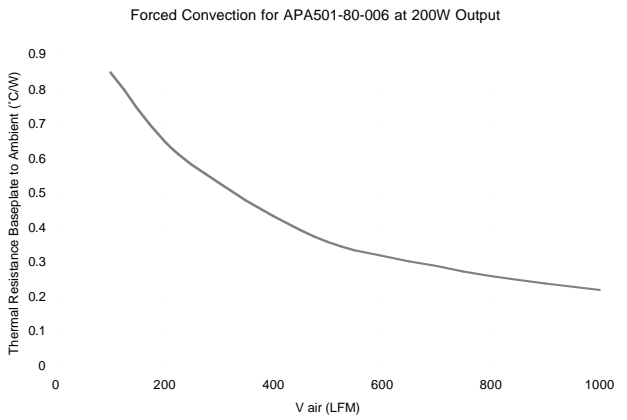

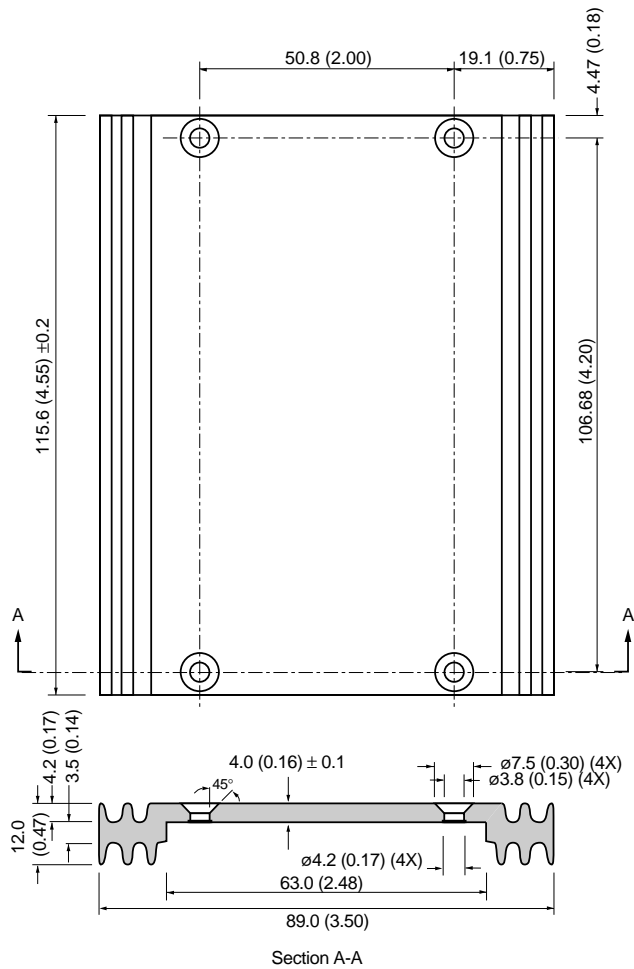

Forced Convection for APA501-80-007 at 200W Output



Thermal Design Process and Example

Temperature & MTBF

APMSS modules are designed to be able to run at baseplate temperatures of 100°C in the case of the AM80 series and 85°C for other series. However, for normal operation the modules should not be run at the maximum allowable temperature since the Mean Time Between Failures (MTBF) will reduce sharply as temperature increases. For example, an AM80-300L-050F40 operating at 5V@40A output, with a baseplate temperature of 50°C, has an MTBF of over one million hours. If the temperature is doubled to 100°C this figure drops to 155,000 hours. The following rules should be followed to ensure reliable operation -

- At the maximum system ambient temperature the **APMSS** baseplate temperature rating should not be exceeded.
- At the normal system ambient operating temperature the **APMSS** baseplate temperature must be low enough to meet MTBF requirements.

The Thermal Design Process

1. Determine heat generated by module from its losses. The minimum efficiency at relevant line and load conditions should be used in calculating the losses.
2. Determine maximum baseplate temperature rise to stay within module temperature rating at maximum system ambient.
3. Define maximum system baseplate temperature to meet MTBF in normal system operating conditions or at the temperature at which the MTBF is specified.
4. Select/design heatsink and airflow requirement.
5. Test using the **APMSS** imbedded TEMP-MON feature which allows direct and convenient monitoring of baseplate temperature. (BM/AM/AL/AK Series)

Thermal Design Example

This example is for the following parameters:

- Single 5V AM80 module used in a distributed power system.
- Average load 30A (150 Watts)
- Normal operating ambient temperature 25°C
- Maximum ambient temperature 60°C
- MTBF required - 800,000 hours (from system requirements)
- Efficiency measured at 83% (Efficiency = Output power/ Input power)

$$\begin{aligned}
 1. \text{ Heat generated} &= \text{Power Out} \times [(1/\text{Efficiency})-1] \\
 &= 150 \times [(1/0.83)-1] \\
 &= \underline{31 \text{ Watt}}
 \end{aligned}$$

2. Maximum baseplate temperature 100°C (from AM80 specifications).
 ⇒ At 60 °C (max. ambient temp.) the maximum baseplate temperature rise is 40°C.

3. To achieve 800,000 hours MTBF, baseplate temperature must not exceed 61°C.
 ⇒ Maximum baseplate temperature rise (from 25°C operating ambient) is 36°C.

4. Choose the lowest temperature rise of ② or ③ i.e. 36°C.
 The cooling system must dissipate 31 Watts with a maximum baseplate temperature rise of 36°C.
 ⇒ Thermal resistance = 36/31 = 1.16°C/Watt.

To ensure good thermal contact Astec recommends the use of Thermstrate® thermal mounting pads. Thermal resistance of the Thermstrate® interface between baseplate and heatsink is 0.1°C/W.

For this example (overall thermal resistance 1.16 °C/W) the heatsink thermal resistance should be a maximum of 1.06°C/W. A 10% safety margin is desirable so a heatsink achieving 0.95°C/W is chosen.

To achieve this level of cooling using natural convection would require an very large heatsink. It would therefore be better to employ forced air cooling. A thermal resistance vs air flow characteristic should be referenced to determine the required airflow for the heatsink you are using.

Tips on installation of <i>AMPSS</i> modules	✓	✗
1. Ensure that the module/heatsink interface is smooth, flat and free of debris. Always use either thermal grease or AMPSS thermal pads.		
2. Fit modules and other heat generating devices at the top of the cabinet where possible.		
3. Stagger modules to improve cooling and facilitate even heat distribution between modules.		
4. Avoid blocking the airflow to the modules with other components.		
5. Use a heatsink with fins running vertically for natural convection cooling.		

For further information contact :

NORTH AMERICA

ASTECC AMERICA, INC.
5810 Van Allen Way
Carlsbad, CA 92008
USA
Tel : 760-930-4600
Fax : 760-930-4700

EUROPE

ASTECC EUROPE LTD.
Astec House, Waterfront Bus. Park
Merry Hill, Dudley
West Midlands
DY5 1LX
U.K.
Tel : 44-1384-842211
Fax : 44-1384-843355

ASIA

ASTECC ASIA
6F., China Dyeing Works Building
382-392 Castle Peak Road
Tsuen Wan
N.T.
Hong Kong
Tel : 852-2437-9662
Fax : 852-2402-4426



Компания «Океан Электроники» предлагает заключение долгосрочных отношений при поставках импортных электронных компонентов на взаимовыгодных условиях!

Наши преимущества:

- Поставка оригинальных импортных электронных компонентов напрямую с производств Америки, Европы и Азии, а так же с крупнейших складов мира;
- Широкая линейка поставок активных и пассивных импортных электронных компонентов (более 30 млн. наименований);
- Поставка сложных, дефицитных, либо снятых с производства позиций;
- Оперативные сроки поставки под заказ (от 5 рабочих дней);
- Экспресс доставка в любую точку России;
- Помощь Конструкторского Отдела и консультации квалифицированных инженеров;
- Техническая поддержка проекта, помощь в подборе аналогов, поставка прототипов;
- Поставка электронных компонентов под контролем ВП;
- Система менеджмента качества сертифицирована по Международному стандарту ISO 9001;
- При необходимости вся продукция военного и аэрокосмического назначения проходит испытания и сертификацию в лаборатории (по согласованию с заказчиком);
- Поставка специализированных компонентов военного и аэрокосмического уровня качества (Xilinx, Altera, Analog Devices, Intersil, Interpoint, Microsemi, Actel, Aeroflex, Peregrine, VPT, Syfer, Eurofarad, Texas Instruments, MS Kennedy, Miteq, Cobham, E2V, MA-COM, Hittite, Mini-Circuits, General Dynamics и др.);

Компания «Океан Электроники» является официальным дистрибьютором и эксклюзивным представителем в России одного из крупнейших производителей разъемов военного и аэрокосмического назначения «JONHON», а так же официальным дистрибьютором и эксклюзивным представителем в России производителя высокотехнологичных и надежных решений для передачи СВЧ сигналов «FORSTAR».



JONHON

«JONHON» (основан в 1970 г.)

Разъемы специального, военного и аэрокосмического назначения:

(Применяются в военной, авиационной, аэрокосмической, морской, железнодорожной, горно- и нефтедобывающей отраслях промышленности)

«FORSTAR» (основан в 1998 г.)

ВЧ соединители, коаксиальные кабели,
кабельные сборки и микроволновые компоненты:

(Применяются в телекоммуникациях гражданского и специального назначения, в средствах связи, РЛС, а так же военной, авиационной и аэрокосмической отраслях промышленности).



Телефон: 8 (812) 309-75-97 (многоканальный)

Факс: 8 (812) 320-03-32

Электронная почта: ocean@oceanchips.ru

Web: <http://oceanchips.ru/>

Адрес: 198099, г. Санкт-Петербург, ул. Калинина, д. 2, корп. 4, лит. А