

PT39 LEDs

Thermally Enhanced

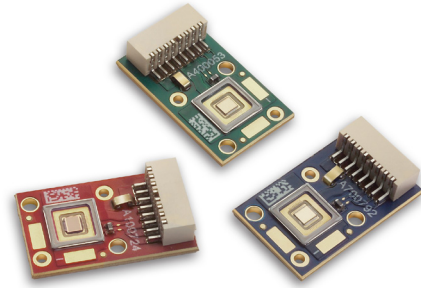

Table of Contents

Technology Overview2

Understanding Big Chip Test Specifications2

Ordering Information3

Flux /Power Bin Definition . . .4

Optical & Electrical Characteristics 5- 6

Blue Flux Bin Ranges by Wavelength7

Characterization Curves8

Spectrum and Angular Intensity Distribution9

Thermal Resistance 10

Mechanical Dimensions 11-12

Shipping Tray Outline 13

Packing and Shipping Specifications 14

History of Changes 15

Features:

- Matched RGB Chipset with 3.9 mm² emitting area designed for LED projector applications
- Enhanced thermal performance allows for operation up to 12 A (3A/mm²)
- Ultra low thermal resistance, common anode copper-core PCB package
- Photonic lattice technology for very high surface brightness and uniform surface emission
- Wide color gamut: Red-Amber 613nm, GREEN 525 nm, Blue 460nm typical dominant wavelength
- Single emitting area per color allows for collection with single lens for simplified optics
- LED mounted on MC-PCB for easier thermal and optical integration
- Aspect ratio optimized and compatible with micro-display diagonal sizes ranging from 0.45" to 0.55"
- RoHS (EU-2002/95/EC Directive) and REACH compliant

Applications

- Specifically engineered for high brightness pocket-size, ultra portable front projectors, head-up projection displays and hybrid projectors
- Optimized for Micro-Display diagonal sizes ranging from 0.45" to 0.55"
- Suitable for DLP™ (0.45" WXGA, 0.55" SVGA), LCoS and HTPS /3LCD microdisplays

Technology Overview

Luminus Big Chip LEDs™ benefit from a suite of innovations in the fields of chip technology, packaging and thermal management. These breakthroughs allow illumination engineers and system designers to achieve solutions that are high brightness and high efficiency.

Photonic Lattice Technology

Luminus' photonic lattice technology enables large area LED chips with uniform brightness over the entire LED chip surface. The optical power and brightness produced by these large monolithic chips enable solutions which replace arc and halogen lamps where arrays of traditional high power LEDs cannot.

Packaging Technology

Thermal management is critical in high power LED applications. With a thermal resistance from junction to case of 1.0° C/W, Luminus PT39 LEDs can be driven at higher current densities while maintaining a low junction temperature, thereby resulting in brighter solutions and longer lifetimes.

Reliability

For high power operation, Luminus Big Chip LEDs are one of the most reliable light sources in the world today. Big Chip LEDs have passed a rigorous suite of environmental and mechanical stress tests, including mechanical shock, vibration, temperature

cycling and humidity, and have been fully qualified for use in extreme high power and high current applications. With very low failure rates and median lifetimes that typically exceed 60,000 hours, Luminus Big Chip LEDs are ready for even the most demanding applications. (Please refer to Luminus' Reliability application note for more information.)

Environmental Benefits

Luminus LEDs help reduce power consumption and the amount of hazardous waste entering the environment. All Big Chip LED products manufactured by Luminus are RoHS and REACH compliant and free of hazardous materials, including lead and mercury.

Understanding Big Chip LED Test Specifications

Every Luminus LED is extensively tested at rated current to ensure that it meets the high quality standards expected from Luminus products.

Testing of Big Chip LEDs

Luminus core board products are typically measured in such a way that the characteristics reported agree with how the devices will actually perform when incorporated into a system. This measurement is accomplished by mounting the devices on a 40° C heat sink and allowing the device to reach thermal equilibrium while fully powered. Only after the device reaches equilibrium are the measurements taken. This method of measurement ensures that Luminus Big Chip LEDs perform in the field just as they are specified.

Luminus surface mount LEDs are typically tested with a 20 ms input pulse and a junction temperature of 25° C. Expected flux

values in real world operation can be extrapolated based on the information contained within this product data sheet.

Ordering Information

Ordering Part Number ¹	Color	Min Flux or Power Bin ²	Description
PT-39-RA-L21-MPF	Red-Amber (Discontinued)	2E	Red-Amber LED, consisting of a 3.9 mm ² Red-Amber LED chip, thermistor and connector mounted on a copper-core PCB.
PT-39-RA-L21-MPG		2F	
PT-39-RA-L21-MPH		2G	
PT-39-RA-L21-MPJ		2H	
PT-39-G-L21-MPF	Green	2F	Green LED, consisting of a 3.9 mm ² Green LED chip, thermistor and connector mounted on a copper-core PCB.
PT-39-G-L21-MPG		2G	
PT-39-G-L21-MPH		2H	
PT-39-G-L21-MPJ		2J	
PT-39-B-L21-EPD	Blue	2G	Blue LED, consisting of a 3.9 mm ² Blue LED chip, thermistor and connector mounted on a copper-core PCB.
PT-39-B-L21-EPE		2H	

Note 1: Ordering part numbers represent bin kits (group of bins that are shippable for a given ordering part number)

Note 2: See Bin Kit and Flux / Power bin definitions on page 4

Ordering Part Number Nomenclature

XXX — 00 — XXXX — X00 — XXX

Product Family	Chip Area	Color	Package Configuration	Bin Kit ¹
PT: Metal Coreboard PCB	39: 3.9 mm ²	RA= Red -Amber (615nm, typ) G= Green B= Blue	L21: 26.5mm x 16.0 mm (standard) L22: 26.5mm x 16.0 mm (die-rotated configuration) See Mechanical Drawing section	See page 4 for bin kit definition

Note 1: A Bin Kit represents a group of individual flux or power bins that are shippable for a given ordering part number. Individual flux bins are not orderable.

EXAMPLE:

PT-39-RA-L21-MPF is comprised of Red-Amber Flux Bins 2E, 2F, 2G, 2H, 2J.

PT39 Bin Kit¹ and Flux Bin^{2,3,4} Definitions

Note: Please refer to ordering part number table on page 3 for Bin Kit availability

Red -Amber Flux Bins	Bin 2E	Bin 2F	Bin 2G	Bin 2H	Bin 2J	Bin 2K	Bin 2L	Bin 2M	
Red -Amber Bin Flux Range (lm) (Discontinued)	635-690	690-745	745-800	800-860	860-925	925-990	990-1055	1055-1125	
PT-39-RA-L21-MPF	☑	☑	☑	☑	☑				
PT-39-RA-L21-MPG		☑	☑	☑	☑	☑			
PT-39-RA-L21-MPH			☑	☑	☑	☑	☑		
PT-39-RA-L21-MPJ				☑	☑	☑	☑	☑	
Green Flux Bins	Bin 2F	Bin 2G	Bin 2H	Bin 2J	Bin 2K	Bin 2L	2M		
Green Bin Flux Range (lm)	1250-1330	1330-1450	1450-1550	1550-1660	1660-1780	1780-1900	1900-2020		
PT-39-G-L21-MPF	☑	☑	☑	☑	☑				
PT-39-G-L21-MPG		☑	☑	☑	☑	☑			
PT-39-G-L21-MPH			☑	☑	☑	☑	☑		
PT-39-G-L21-MPJ				☑	☑	☑	☑		
Blue Flux Bins	Bin 2G	Bin 2H	Bin 2J	Bin 2K	Bin 2L	Bin 2M			
Blue Bin Flux Range (lm)	255-280	280-300	300-320	320-345	345-370	370-400			
PT-39-B-L21-EPD	☑	☑	☑	☑	☑				

Note 1: Bin Kits are defined by a group of flux or power bins. Only one flux bin will be shipped in each individual pack. A shipment will contain packs of different allowed flux bins for a particular ordering part number. Individual Flux or Power bins are not orderable.

Note 2: PT39 LEDs are tested for luminous flux at 9.8 A at 25% duty cycle for Red, Red-Amber and Blue, and at 50% duty cycle for Green Devices. Devices are sorted and packed by flux bin. Not all flux bins are currently populated.

Note 3: Luminus maintains a test measurement accuracy for LED flux and power of +/- 6%.

Note 4: Blue Flux bin limits are defined at reference dominant wavelength of 462nm. See table on page 7 for Blue bin limits at other dominant wavelengths.

Optical & Electrical Characteristics

General Characteristics		Symbol	Red -Amber (Discontinued)	Green	Blue	Unit
Emitting Area		x	3.9	3.9	3.9	mm ²
Emitting Area Dimensions		x	2.09 x 1.87	2.09 x 1.87	2.09 x 1.87	mmxmm
Characteristics at Recommended Test Drive Current , I_f^{1,2}						
Reference Duty Cycle ³			25	50	25	%
Test Peak Drive Current ^{1,2,4}	typ	I _F	9.8	9.8	9.8	A
Peak Luminous Flux ^{1,2,5}	typ	Φ _v	800	1660	300	lm
Peak Radiometric Flux ^{1,2}	typ	Φ _r	3.2	3.5	6.2	W
Dominant Wavelength	min	λ _{dmin}	609	516	450	nm
	typ	λ _d	613	525	460	nm
	max	λ _{dmax}	620	540	468	nm
FWHM- Spectral bandwidth at 50% of Φ _r	typ		19	34	20	nm
Chromaticity Coordinates ^{6,7}	typ	x	0.675	0.167	0.147	
	typ	y	0.325	0.704	0.033	
Forward Voltage	min	V _{Fmin}	2.2	3.5	3.2	V
	typ	V _F	2.6	5.2	3.9	V
	max	V _{Fmax}	3.2	5.9	5.2	V
Dynamic Resistance	typ		0.1	0.12	0.09	Ω
Device Thermal Characteristics						
Thermal Coefficient of Photometric Flux	typ		-1.0	-0.2	~0	% / °C
Thermal Coefficient of Radiometric Flux	typ		-0.7	-0.2	-0.2	% / °C
Forward Voltage Temperature Coefficient	typ		-2	-4.7	-3	mV/ °C
Characteristics at Reference Continuous Drive Current I_F (continuous wave)¹						
Reference Drive Current	typ	I _F	5.9	5.9	5.9	A
Luminous Flux	typ	Φ _v	450	1175	210	lm
Radiometric Flux	typ	Φ _r	1.8	2.5	4.3	W
Dominant Wavelength	typ	λ _d	612	528	461	nm
FWHM -Spectral bandwidth at 50% of Φ _r	typ		18	36	21	nm
Chromaticity Coordinates ^{6,7}	typ	x	0.677	0.177	0.144	nm
	typ	y	0.322	0.713	0.034	nm
Forward Voltage	typ	V _F	2.3	4.5	3.4	V

Optical & Electrical Characteristics

Note 1: All ratings are based on testing conditions with a constant heat sink temperature $T_{hs} = 40^{\circ}\text{C}$. See Thermal Resistance section for T_{hs} definition.

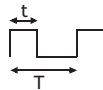
Note 2: Parameters rated at test duty cycle and Pulsed operation frequency $f > 240\text{ Hz}$; $DC = \frac{t}{T}$ 

Note 3: Duty Cycle used to specify device ratings under Pulsed operation. Big Chip LED devices can operate at duty cycles ranging from 1% to 100%. At higher duty cycles, drive current should be adjusted to maintain the junction temperature at desired levels to meet the application lifetime requirements.

Note 4: In pulsed operation, rise time from 10% to 90% of forward current should be larger than 0.5 microseconds

Note 5: For Blue devices, total flux from emitting area at typical dominant wavelength. Refer to page 7 for brightness specifications at other wavelength

Note 6: In CIE 1931 chromaticity diagram coordinates, normalized to $X+Y+Z=1$

Note 7: For Reference only

Absolute Maximum Ratings

	Symbol	Red -Amber (Discontinued)	Green	Blue	Unit
Absolute Minimum Current (CW or Pulsed) ¹		200	200	200	mA
Absolute Maximum Current (CW) ²		9.8	9.8	9.8	A
Absolute Maximum Current (Pulsed) ^{2,3} (frequency > 240Hz, duty cycle <50%)		13.7	13.7	13.7	A
Absolute Maximum Surge Current ^{2,3} (Frequency > 240 Hz, duty cycle =tbd, t=tbd)		TBD	TBD	TBD	A
Absolute Maximum Junction Temperature ⁴	T_{jmax}	125	170	170	$^{\circ}\text{C}$
Storage Temperature Range		-40 / +100	-40 / +100	-40 / +100	$^{\circ}\text{C}$

Note 1: Product performance and lifetime data is specified at recommended forward drive currents. Sustained operation at or near absolute minimum currents may result in a reduction of device performance and device lifetime compared to recommended forward drive currents.

Note 2: Luminus LEDs' absolute maximum forward drive current density is 2.5 A/mm² CW, and 3.5A/mm² pulsed ($f > 240\text{ Hz}$, duty cycle <50%). Please refer to absolute maximum rating table above for specific absolute maximum currents for the products covered in this datasheet. Product lifetime data is specified at recommended forward drive currents. (See Reliability Application Note, APN-001444.) Sustained operation at or above absolute maximum currents will result in a reduction of device lifetime compared to recommended forward drive currents. Actual device lifetimes will also depend on junction temperature. Please refer to lifetime derating curves (available from Luminus) for further information.

Note 3: In pulsed operation, rise time from 10 to 90% of forward current should be larger than 0.5 microseconds.

Note 4: Sustained operation at or above Maximum Operating Junction Temperature (T_{jmax}) will result in reduced device life time.

Blue Bin Flux Ranges by Dominant Wavelength ^{1,2}

DWL (nm)	Bin 2G		Bin2H		Bin 2J		Bin 2K		Bin 2L		Bin 2M	
	Min (lm)	Max (lm)	Min (lm)	Max (lm)	Min (lm)	Max (lm)	Min (lm)	Max (lm)	Min (lm)	Max (lm)	Min (lm)	Max (lm)
450	125	137	137	147	147	156	156	169	169	181	181	196
451	136	149	149	159	159	170	170	183	183	197	197	213
452	146	161	161	172	172	184	184	198	198	212	212	230
453	157	173	173	185	185	197	197	213	213	228	228	247
439	168	185	185	198	198	211	211	227	227	244	244	264
455	179	197	197	211	211	225	225	242	242	260	260	281
456	190	208	208	223	223	238	238	257	257	275	275	298
457	201	220	220	236	236	252	252	272	272	291	291	315
458	212	232	232	249	249	265	265	286	286	307	307	332
459	222	244	244	262	262	279	279	301	301	323	323	349
460	233	256	256	274	274	293	293	316	316	338	338	366
461	244	268	268	287	287	306	306	330	330	354	354	383
462	255	280	280	300	300	320	320	345	345	370	370	400
463	266	292	292	313	313	334	334	360	360	386	386	417
464	277	304	304	326	326	347	347	374	374	402	402	434
465	288	316	316	338	338	361	361	389	389	417	417	451
466	298	328	328	351	351	375	375	404	404	433	433	468
467	309	340	340	364	364	388	388	418	418	449	449	485
468	320	352	352	377	377	402	402	433	433	465	465	502

Note 1: Flux Min, Max values are continuous as function of dominant wavelength values. For illustration purposes, flux Min and Max values are provided at discrete dominant wavelength values.

Note 2: Luminus maintains a test measurement accuracy for LED flux and power of +/- 6%.

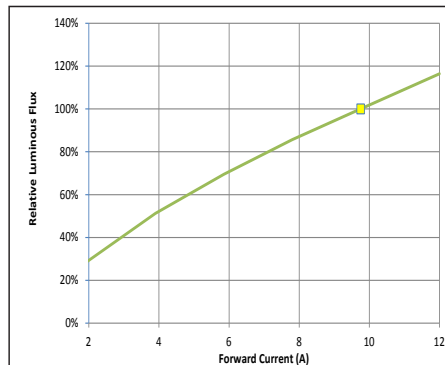
Normalized Luminous Flux variation with Forward Current: $\Phi_V / \Phi_F = f(I_F)$

See notes 1, 2 on page 9.

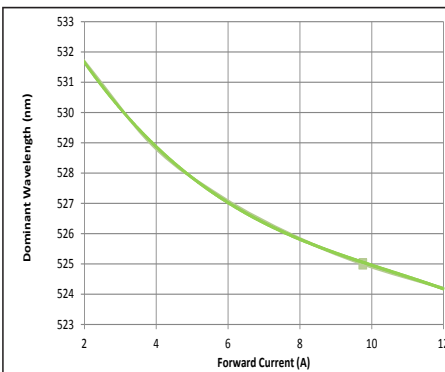
Dominant Wavelength variation with Forward Current - $\lambda_d = f(I_F)$ - Typical

See notes 1, 2 on page 9.

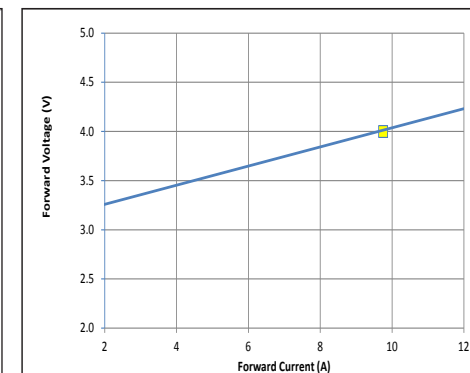
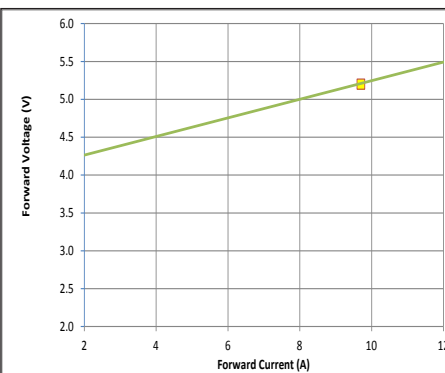
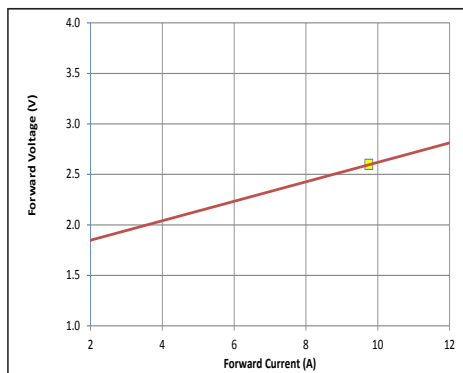
Forward Voltage variation with Drive current - $V_F = f(I_F)$ - Typical

See notes 1, 2 on page 9.

Optical Spectrum (Typical)



See notes 1, 3 on page 9.

Angular Intensity Distribution (Typical)

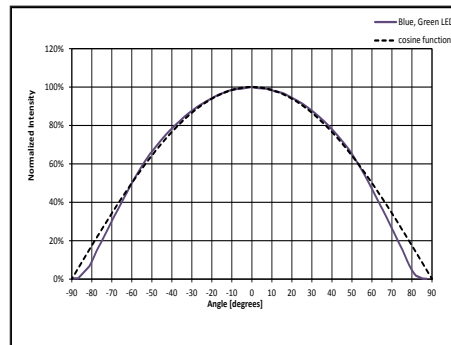

See note 4 on page 9.

- Note 1: For Pulsed operation, the reference R,G, and B duty cycles used are 25%, 50% and 25% respectively ($T_{HS}=40^{\circ}\text{C}$; Frequency = 720 Hz).
- Note 2: Square on curves indicate device operating current point (9.8A) under reference conditions listed in the Optical and Electrical Characteristics table.
- Note 3: Typical spectrum at recommended peak drive current. Please contact Luminus to obtain data in Excel format.
- Note 4: Curves (solid) represent the angular radiation pattern of a typical (Red, Green or Blue) device. Discontinuous line represents cosine function. For any specific device, slight variations may be expected.

Thermal Resistance

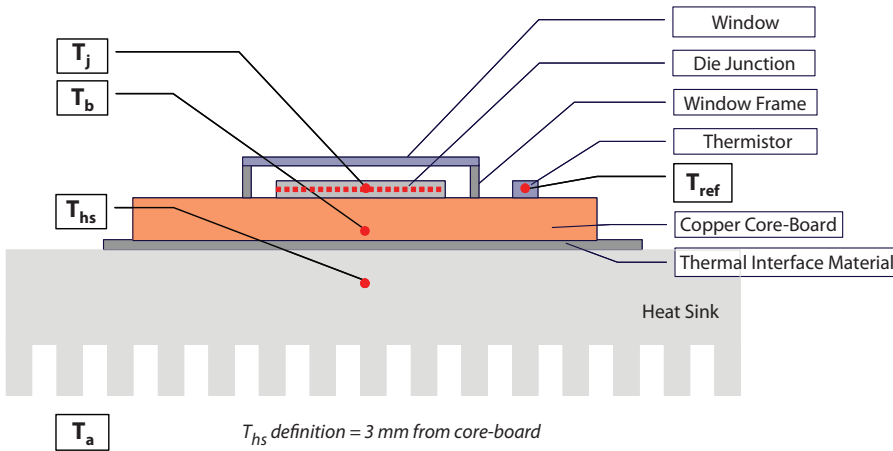

Typical Thermal Resistance

$R_{\theta j-b}^1$	1.0°C/W
$R_{\theta b-hs}^2$	0.2 °C/W
$R_{\theta j-hs}^{1,2}$	1.2 °C/W
$R_{\theta j-ref}^2$	1.0 °C/W

Note 1: Thermal resistance values are based on modeled results correlated to measured $R_{\theta j-hs}$ data using the wavelength shift method. Verification of compliance with the recent releases of JEDEC Standards JESD51-14 and JESD51-5x series is pending.

Note 2: Thermal Resistance is based on eGraf 1205 Thermal interface.

Thermistor Information

The thermistor used in PT39 devices are mounted on coreboards is from Murata Manufacturing Co. The global part number is NCP15XH103J03RC.

Please contact Luminus for information on use of the thermistor and for data in Excel format for temperature vs. resistance plot below.

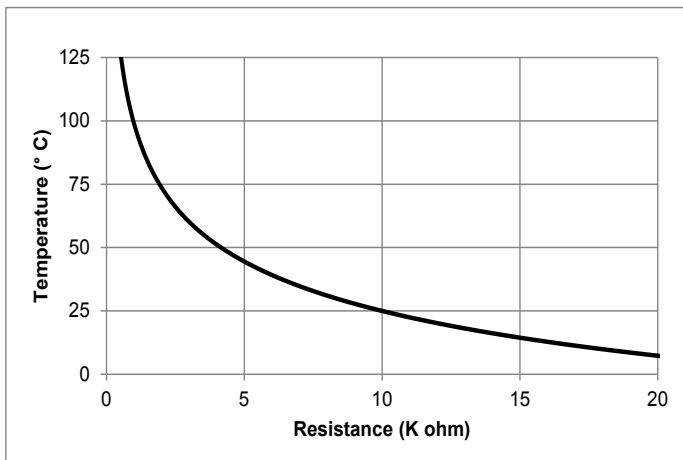

Electrical Pinout

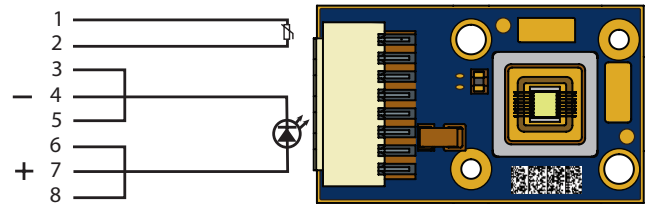

Mechanical Dimensions - Standard Die Configuration

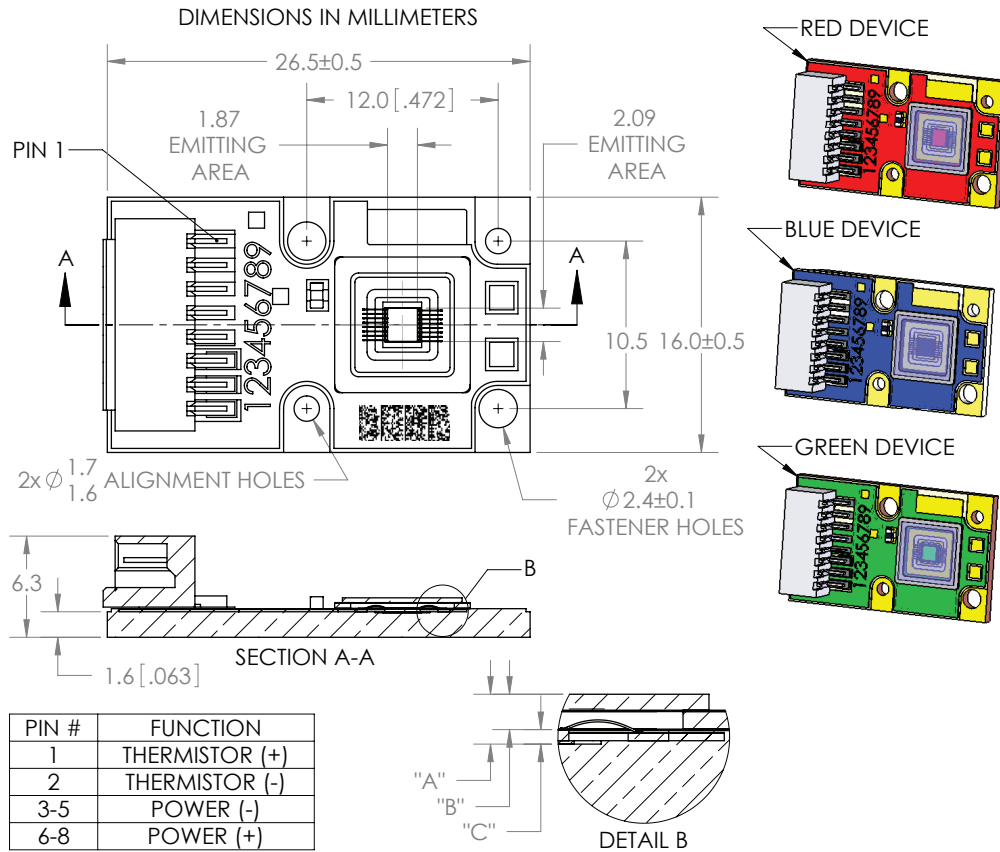

DIMENSION NAME	DESCRIPTION	NOMINAL DIMENSION	TOLERANCE
"A"	TOP OF METAL SUBSTRATE TO TOP OF GLASS	0.90	±0.13
"B"	EMITTING AREA TO TOP OF GLASS	0.67	± 0.16
"C"	TOP OF METAL SUBSTRATE TO EMITTING AREA	0.23	± 0.05

DWG-001989

Notes:

- 1) Red, Green and Blue PT39 Big Chip LEDs are individually assembled into a common anode copper core-board with a footprint of 26.5 mm x 16 mm.
- 2) Dimensions above are for information only. Please refer to the latest revision of the DWG- 001989 package outline mechanical specifications.
- 3) Connector- MOLEX Part Number: 874380843 or Global Part Number: WTB16-0815F.

Mechanical Dimensions – Rotated Die Configuration



DWG-001991

Notes:

- 1) Red, Green and Blue PT39 Big Chip LEDs are individually assembled into a common anode copper core-board with a footprint of 26.5 mm x 16 mm.
- 2) Dimensions above are for information only. Refer to the latest revision of the DWG- 001991, package outline mechanical specifications
- 3) Connector- MOLEX Part Number: 874380843 or Global Part Number: WTB16-0815F.

Shipping Tray Outline

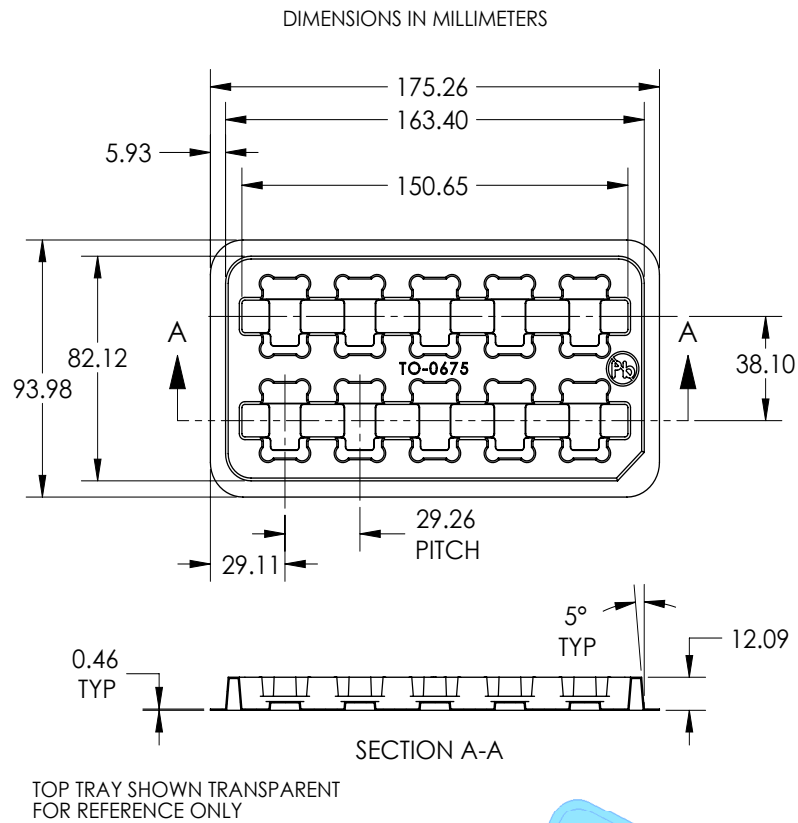

For detailed drawing of shipping trays, please refer to document TO-0675 , available upon request.

Packing and Shipping Specifications

Packing Specification

Packing Configuration	Qty /Pack	Reel Dimensions (diameter x W, mm)	Gross Weight (kg)
Stack of 5 trays with 10 devices per tray Each pack is enclosed in ESD bag	50	95 x 176 x 50	0.45

Product Label Specification

Label Fields:

- 6-8 digit Box number (for Luminus internal use)
- Luminus ordering part number
- Quantity of devices in pack
- Part number revision (for Luminus internal use)
- Customer's part number (optional)
- Flux Bin
- 2D Bar code





BP-012345

 Box number

PT-39-G-L21-MPH

 Luminus part number

12345678

 Customer part number

2J

 Bin

Qty: 50

Rev 01



for traceability peel off label and attach

RoHS Compliant

Sample label –for illustration only

Shipping Box

Shipping Box	Quantity	Material	Dimensions (L x W x H, mm)
Carton Box	1 -20 packs	S4651	560 x 560 x 200

History of Changes

Rev	Date	Description of Change
X	03/23/12	Preliminary Draft
01	05/15/12	Preliminary Specification
02	08/28/12	Add product characterization curves
03	02/17/15	Update address and year, remove preliminary marks

The products, their specifications and other information appearing in this document are subject to change by Luminus Devices without notice. Luminus Devices assumes no liability for errors that may appear in this document, and no liability otherwise arising from the application or use of the product or information contained herein. None of the information provided herein should be considered to be a representation of the fitness or suitability of the product for any particular application or as any other form of warranty. Luminus Devices' product warranties are limited to only such warranties as accompany a purchase contract or purchase order for such products. Nothing herein is to be construed as constituting an additional warranty. No information contained in this publication may be considered as a waiver by Luminus Devices of any intellectual property rights that Luminus Devices may have in such information. Big Chip LEDs™ is a registered trademark of Luminus Devices, Inc., all rights reserved.

This product is protected by U.S. Patents 6,831,302; 7,074,631; 7,083,993; 7,084,434; 7,098,589; 7,105,861; 7,138,666; 7,166,870; 7,166,871; 7,170,100; 7,196,354; 7,211,831; 7,262,550; 7,274,043; 7,301,271; 7,341,880; 7,344,903; 7,345,416; 7,348,603; 7,388,233; 7,391,059 Patents Pending in the U.S. and other countries.

Компания «Океан Электроники» предлагает заключение долгосрочных отношений при поставках импортных электронных компонентов на взаимовыгодных условиях!

Наши преимущества:

- Поставка оригинальных импортных электронных компонентов напрямую с производств Америки, Европы и Азии, а так же с крупнейших складов мира;
- Широкая линейка поставок активных и пассивных импортных электронных компонентов (более 30 млн. наименований);
- Поставка сложных, дефицитных, либо снятых с производства позиций;
- Оперативные сроки поставки под заказ (от 5 рабочих дней);
- Экспресс доставка в любую точку России;
- Помощь Конструкторского Отдела и консультации квалифицированных инженеров;
- Техническая поддержка проекта, помощь в подборе аналогов, поставка прототипов;
- Поставка электронных компонентов под контролем ВП;
- Система менеджмента качества сертифицирована по Международному стандарту ISO 9001;
- При необходимости вся продукция военного и аэрокосмического назначения проходит испытания и сертификацию в лаборатории (по согласованию с заказчиком);
- Поставка специализированных компонентов военного и аэрокосмического уровня качества (Xilinx, Altera, Analog Devices, Intersil, Interpoint, Microsemi, Actel, Aeroflex, Peregrine, VPT, Syfer, Eurofarad, Texas Instruments, MS Kennedy, Miteq, Cobham, E2V, MA-COM, Hittite, Mini-Circuits, General Dynamics и др.);

Компания «Океан Электроники» является официальным дистрибьютором и эксклюзивным представителем в России одного из крупнейших производителей разъемов военного и аэрокосмического назначения «JONHON», а так же официальным дистрибьютором и эксклюзивным представителем в России производителя высокотехнологичных и надежных решений для передачи СВЧ сигналов «FORSTAR».



JONHON

«JONHON» (основан в 1970 г.)

Разъемы специального, военного и аэрокосмического назначения:

(Применяются в военной, авиационной, аэрокосмической, морской, железнодорожной, горно- и нефтедобывающей отраслях промышленности)

«FORSTAR» (основан в 1998 г.)

ВЧ соединители, коаксиальные кабели, кабельные сборки и микроволновые компоненты:

(Применяются в телекоммуникациях гражданского и специального назначения, в средствах связи, РЛС, а так же военной, авиационной и аэрокосмической отраслях промышленности).



Телефон: 8 (812) 309-75-97 (многоканальный)

Факс: 8 (812) 320-03-32

Электронная почта: ocean@oceanchips.ru

Web: <http://oceanchips.ru/>

Адрес: 198099, г. Санкт-Петербург, ул. Калинина, д. 2, корп. 4, лит. А