600 mA 6 MHz Synchronous Step-down DC/DC Converter

NO. EA-318-151124

OUTLINE

The RP508x is a low supply current CMOS-based PWM/VFM step-down DC/DC converter with synchronous rectifier featuring 600 mA^{*1} output current. Internally, a single converter consists of an oscillator, a reference voltage unit, an error amplifier, a switching control circuit, a mode control circuit, a soft-start circuit, an under-voltage lockout (UVLO) circuit, an over current protection circuit, a thermal shutdown circuit and switching transistors.

By the adoption of the synchronous rectification circuit with built-in switching transistors, the RP508x works as super efficient step-down DC/DC converter, without connecting external diodes. Using synchronous rectification not only increases circuit performance but also allows a design to reduce parts count.

Power controlling method can be selected from forced PWM control type or PWM/VFM auto switching control type by inputting a signal to the MODE pin. In low output current, forced PWM control switches at fixed frequency rate in order to reduce noise. Likewise, in low output current, PWM/VFM auto switching control automatically switches from PWM mode to VFM mode in order to achieve high efficiency.

Output voltage is internally fixed type which allows output voltages that range from 0.8 V to 3.3 V in 0.1 V step. The output voltage accuracy is as high as $\pm 1.5\%$ or ± 18 mV.

Protection circuits included in the RP508x are over current protection circuit and thermal shutdown circuit. Over current protection circuit supervises the inductor peak current in each switching cycle, and if the current exceeds the I_{LX} current limit (I_{LXLIM}), it turns off P-channel Tr. Thermal shutdown circuit detects overheating of the converter if the output pin is shorted to the ground pin (GND) etc. and stops the converter operation to protect it from damage if the junction temperature exceeds the specified temperature.

The RP508x is offered in a small and thin 6-pin DFN(PLP)1212-6F package which achieves the smallest possible footprint solution on boards where area is limited.

For an input capacitor (C_{IN}) and an output capacitor (C_{OUT}), the smaller sized 0402/1005 (inch/mm) capacitor can be used. For an inductor (L), the smaller sized 0603/1608 or 1005/2012 (inch/mm) inductor can be used.

^{*1} This is an approximate value. The output current is dependent on conditions and external components.

FEATURES

- Input Voltage Range (V_{IN}) 2.3 V to 5.5 V (Absolute Maximum Ratings: 6.5 V)
- Output Voltage Range (V_{OUT}) 0.8 V to 3.3 V (Adjustable in 0.1 V steps)
- Supply Current (I_{DD2}) Typ. 15 μ A (VFM Mode with No-load)
- Standby Current ($I_{standby}$) Typ. 0 μ A
- Output Voltage Temperature Coefficient ($\Delta V_{OUT}/T_a$) Typ. ± 100 ppm/ $^{\circ}$ C
- Oscillator Frequency (f_{osc}) Typ. 6.0 MHz
- Maximum Duty Cycle (Maxduty) 100%
- Built-in Driver ON Resistance (R_{ONP} , R_{ONN}) Typ. Pch. 0.33 Ω , Nch. 0.24 Ω ($V_{IN} = 3.6$ V)
- UVLO Detector Threshold (V_{UVLO01}) Typ. 2.0 V
- Soft-start Time (t_{start}) Typ. 90 μ s
- L_x Current Limit Circuit (I_{LXLIM}) Typ. 1.1 A
- Output Voltage Accuracy $\pm 1.5\%$ ($V_{OUT} \geq 1.2$ V) or ± 18 mV ($V_{OUT} < 1.2$ V)
- Package DFN(PLP)1212-6F

APPLICATIONS

- Cellular Phones
- Smartphones
- Digital Still Camera
- Notebook PCs, PDA's
- Li-ion Battery-used Equipment

BLOCK DIAGRAM

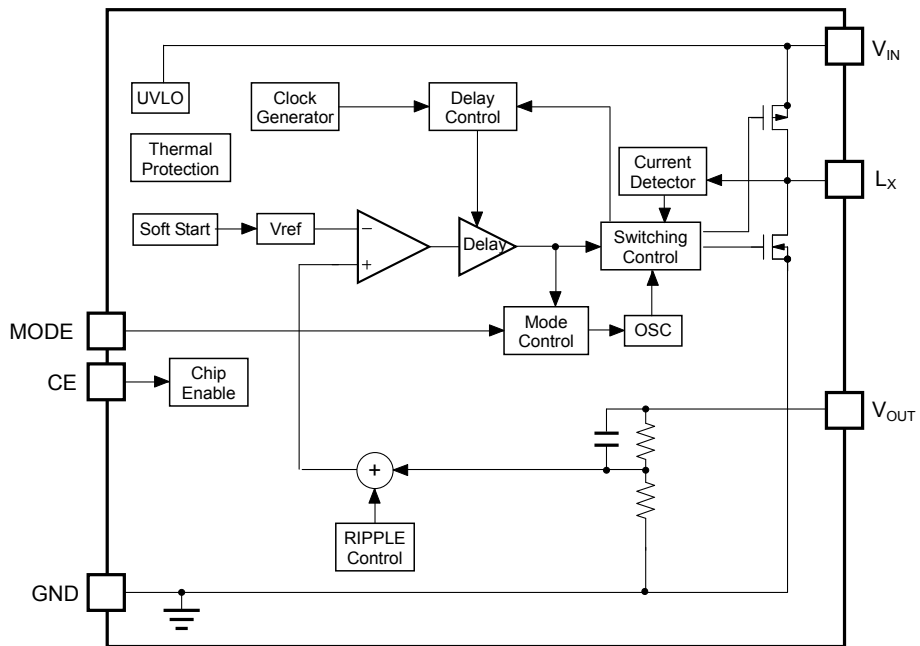

RP508xxx1A Block Diagram

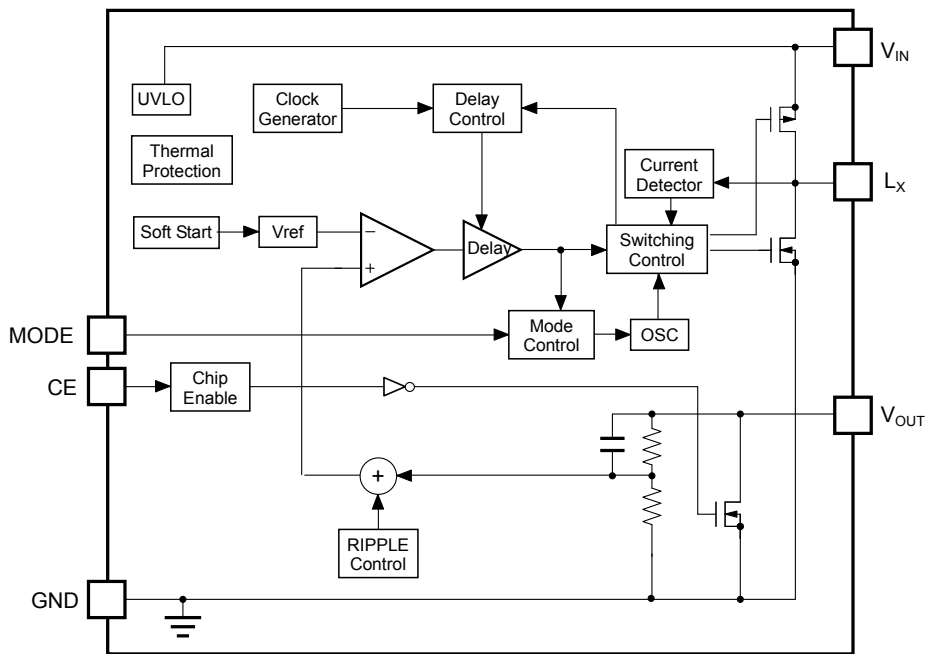

RP508xxx1B Block Diagram

SELECTION GUIDE

The set output voltage and the auto discharge^{*1} function are user-selectable options.

Selection Guide

Product Name	Package	Quantity per Reel	Pb Free	Halogen Free
RP508Kxx1\$-TR	DFN(PLP)1212-6F	5,000 pcs	Yes	Yes

xx: Specify the set output voltage (V_{SET}) within the range of 0.8 V (08) to 3.3 V (33) in 0.1 V^{*2} steps.

If the set output voltage includes the 3rd digit, indicate the digit of 0.01.
(1.05 V, 1.25 V, 1.35 V)

Ex. If the set output voltage is 1.05 V: RP508K101\$5
If the set output voltage is 1.25 V: RP508K121\$5
If the set output voltage is 1.35 V: RP508K131\$5

\$: Specify the auto-discharge option.

A: Fixed output voltage type
B: Fixed output voltage type, auto-discharge function in shutdown mode

^{*1} Auto-discharge function quickly lowers the output voltage to 0 V, when the chip enable signal is switched from the active mode to the standby mode, by releasing the electrical charge accumulated in the external capacitor.

^{*2} 0.05 V step is also available as a custom code.

PIN DESCRIPTION

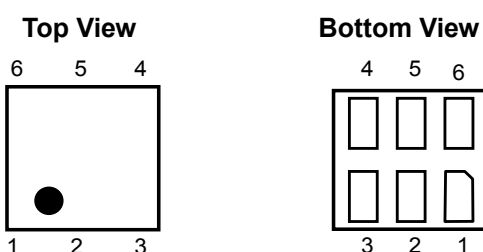

DFN(PLP)1212-6F Pin Configurations

Pin Description

Pin No.	Symbol	Pin Description
1	V_{OUT}	Output Pin
2	MODE	Mode Control Pin ("H" forced PWM control, "L" PWM/VFM auto switching control)
3	CE	Chip Enable Pin ("H" active)
4	V_{IN}	Input Pin
5	L_X	L_X Switching Pin
6	GND	Ground Pin

ABSOLUTE MAXIMUM RATINGS

Absolute Maximum Ratings

Symbol	Item	Rating	Unit
V_{IN}	V_{IN} Input Voltage	-0.3 to 6.5	V
V_{LX}	L_X Pin Voltage	-0.3 to $V_{IN} + 0.3$	V
V_{CE}	CE Pin Input Voltage	-0.3 to 6.5	V
V_{MODE}	MODE Pin Input Voltage	-0.3 to 6.5	V
V_{OUT}	V_{OUT} Pin Voltage	-0.3 to 6.5	V
I_{LX}	L_X Pin Output Current	1300	mA
P_D	Power Dissipation (JEDEC STD 51-7 Test Land Pattern) ^{*1}	666	mW
T_a	Operating Temperature Range	-40 to 85	°C
T_{stg}	Storage Temperature Range	-55 to 125	°C

^{*1} Refer to the section of *PACKAGE INFORMATION* for detailed information.

ABSOLUTE MAXIMUM RATINGS

Electronic and mechanical stress momentarily exceeded absolute maximum ratings may cause the permanent damages and may degrade the life time and safety for both device and system using the device in the field. The functional operation at or over these absolute maximum ratings are not assured.

RECOMMENDED OPERATING CONDITIONS (ELECTRICAL CHARACTERISTICS)

All of electronic equipment should be designed that the mounted semiconductor devices operate within the recommended operating conditions. The semiconductor devices cannot operate normally over the recommended operating conditions, even if when they are used over such conditions by momentary electronic noise or surge. And the semiconductor devices may receive serious damage when they continue to operate over the recommended operating conditions.

ELECTRICAL CHARACTERISTICS

Electrical Characteristics

(Ta = 25°C)

Symbol	Item	Conditions	Min.	Typ.	Max.	Unit	
V _{IN}	Operating Input Voltage		2.3		5.5	V	
V _{OUT}	Output Voltage	V _{IN} = V _{CE} = 3.6 V	V _{SET} ≥ 1.2 V	x0.985	x1.015	V	
			V _{SET} < 1.2 V	-0.018	+0.018	V	
ΔV _{OUT} / ΔTa	Output Voltage Temperature Coefficient	-40°C ≤ Ta ≤ 85°C		±100		ppm / °C	
fosc	Oscillator Frequency	*1	5.4	6.0	6.6	MHz	
I _{DD1}	Supply Current 1	V _{IN} = V _{CE} = 5.5 V, V _{OUT} = V _{SET} × 0.8		1000	1300	μA	
I _{DD2}	Supply Current 2	V _{IN} = V _{CE} = V _{OUT} = 5.5 V	V _{MODE} = 0 V		15	25	μA
			V _{MODE} = 5.5 V		1000	1300	μA
I _{standby}	Standby Current	V _{IN} = 5.5 V, V _{CE} = 0 V		0	5	μA	
I _{CEH}	CE "H" Input Current	V _{IN} = V _{CE} = 5.5 V	-1	0	1	μA	
I _{CEL}	CE "L" Input Current	V _{IN} = 5.5 V, V _{CE} = 0 V	-1	0	1	μA	
I _{MODEH}	Mode "H" Input Current	V _{IN} = V _{MODE} = 5.5 V, V _{CE} = 0 V	-1	0	1	μA	
I _{MODEL}	Mode "L" Input Current	V _{IN} = 5.5 V, V _{CE} = V _{MODE} = 0 V	-1	0	1	μA	
I _{VOUTH}	V _{OUT} "H" Input Current*2	V _{IN} = V _{OUT} = 5.5 V, V _{CE} = 0 V	-1	0	1	μA	
I _{VOUTL}	V _{OUT} "L" Input Current	V _{IN} = 5.5 V, V _{CE} = V _{OUT} = 0 V	-1	0	1	μA	
R _{LOW}	On Resistance for Auto Discharge*3	V _{IN} = 3.6 V, V _{CE} = 0 V		30		Ω	
I _{LXLEAKH}	L _X Leakage Current "H"	V _{IN} = V _{LX} = 5.5 V, V _{CE} = 0 V	-1	0	5	μA	
I _{LXLEAKL}	L _X Leakage Current "L"	V _{IN} = 5.5 V, V _{CE} = V _{LX} = 0 V	-5	0	1	μA	
V _{CEH}	CE "H" Input Voltage	V _{IN} = 5.5 V	1.0			V	
V _{CEL}	CE "L" Input Voltage	V _{IN} = 2.3 V			0.4	V	
V _{MODEH}	Mode "H" Input Voltage	V _{IN} = V _{CE} = 5.5 V	1.0			V	
V _{MODEL}	Mode "L" Input Voltage	V _{IN} = V _{CE} = 2.3 V			0.4	V	
R _{ONP}	On Resistance of Pch Tr.	V _{IN} = 3.6 V, I _{LX} = -100 mA		0.33		Ω	
R _{ONN}	On Resistance of Nch Tr.	V _{IN} = 3.6 V, I _{LX} = -100 mA		0.24		Ω	
Maxduty	Maximum Duty Cycle		100			%	
t _{start}	Soft-start Time	*4		90	150	μs	
I _{LXLIM}	L _X Current Limit		900	1100		mA	
V _{UVLO1}	UVLO Detector Threshold	V _{IN} = V _{CE}	1.9	2.0	2.1	V	
V _{UVLO2}	UVLO Released Voltage	V _{IN} = V _{CE}	2.0	2.1	2.2	V	
T _{TSD}	Thermal Shutdown Temperature	Junction Temperature		140		°C	
T _{TSR}	Thermal Shutdown Released Temperature	Junction Temperature		100		°C	

All test items listed under *ELECTRICAL CHARACTERISTICS* are done under the pulse load condition (T_j ≈ Ta = 25°C) except Output Voltage Temperature Coefficient.

*1 V_{IN} = V_{CE} = 3.6 V (V_{SET} ≤ 2.6 V), V_{IN} = V_{CE} = V_{SET} + 1 V (V_{SET} > 2.6 V)

*2 RP508xxx1A only

*3 RP508xxx1B only

*4 Soft-start Time is between the rising edge of CE pin and V_{OUT} ≥ V_{SET} × 0.9.

TYPICAL APPLICATION



RP508x Typical Application

Recommended Components

Symbol	Size	Type	Manufacturer
C _{IN}	2.2 μF	Ceramic	C1005JB0J225K (TDK)
	4.7 μF	Ceramic	C1005JB0J475K (TDK)
C _{OUT}	4.7 μF	Ceramic	C1005JB0J475K (TDK)
L	0.47 μH (0.5 μH)	Inductor	MIPSZ2012D0R5 (FDK)
			MDT1608CHR47N (TOKO)
	1.0 μH	Inductor	MIPSZ2012D1R0 (FDK)
			MDT1608CH1R0N (TOKO)

TECHNICAL NOTES

- Ensure the V_{IN} and GND lines are sufficiently robust. A large switching current flows through the GND lines, the V_{DD} line, the V_{OUT} line, an inductor, and L_X . If their impedance is too high, noise pickup or unstable operation may result. Set the external components as close as possible to the IC and minimize the wiring between the components and the IC, especially between a capacitor (C_{IN}) and the V_{IN} pin. The wiring between V_{OUT} and load and between L and V_{OUT} should be separated.
- Choose a low ESR ceramic capacitor. The capacitance of C_{IN} should be more than or equal to 2.2 μF . The capacitance of a capacitor (C_{OUT}) should be between 4.7 μF to 10 μF .
- The Inductance value should be set within the range of 0.47 μH to 1.0 μH . However, the inductance value is limited by output voltage. Refer to the table below. The phase compensation of this IC is designed according to the C_{OUT} and L values. Choose an inductor that has small DC resistance, has enough allowable current and is hard to cause magnetic saturation. If the inductance value of an inductor is extremely small, the peak current of L_X may increase. The increased L_X peak current reaches “ L_X limit current” to trigger over current protection circuit even if the load current is less than 600 mA.

Set Output Voltage Range vs. Inductance Range

Set Output Voltage (V)	Input Voltage (V)	Inductance	
V_{SET}	V_{IN}	L = 0.47 μH	L = 1.0 μH
0.8 to 1.2	up to 5.5	Recommended	Acceptable
1.3 to 1.5	up to 4.5	Recommended	Acceptable
	4.5 to 5.5	Acceptable	Recommended
1.6 to 2.6	up to 3.6	Recommended	Acceptable
	up to 4.5	Acceptable	Recommended
	4.5 to 5.5	-	Recommended
2.7 to 3.3	up to 4.5	Recommended	Acceptable
	4.5 to 5.5	-	Recommended

- Over current protection circuit may be affected by self-heating or power dissipation environment.
- The performance of power source circuits using this IC largely depends on the peripheral circuits. When selecting the peripheral components, consider the conditions of use. Do not allow each component, PCB pattern and the IC to exceed their respected rated values (voltage, current and power) when designing the peripheral circuits.

OPERATION OF STEP-DOWN DC/DC CONVERTER AND OUTPUT CURRENT

The step-down DC/DC converter charges energy in the inductor when L_x Tr. turns “ON”, and discharges the energy from the inductor when L_x Tr. turns “OFF” and operates with less energy loss, so that a lower output voltage (V_{OUT}) than the input voltage (V_{IN}) can be obtained.

The operation of the step-down DC/DC converter is explained in the following figures.



Figure 1. Basic Circuit

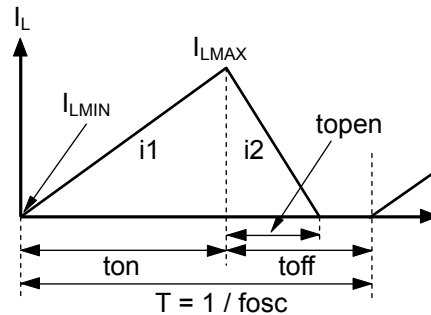

Figure 2. Inductor Current (I_L) flowing through Inductor

Step1. P-channel Tr. turns “ON” and the inductor current ($I_L = i1$) flows, L is charged with energy. At this moment, $i1$ increases from the minimum inductor current (I_{LMIN}), which is 0 A, and reaches the maximum inductor current (I_{LMAX}) in proportion to the on-time period (ton) of P-channel Tr.

Step2. When P-channel Tr. turns “OFF”, L tries to maintain I_L at I_{LMAX} , so L turns N-channel Tr. “ON” and the inductor current ($I_L = i2$) flows into L.

Step3. $i2$ decreases gradually and reaches I_{LMIN} after the open-time period ($topen$) of N-channel Tr., and then N-channel Tr. turns “OFF”. This is called discontinuous current mode.

As the output current (I_{OUT}) increases, the off-time period ($toff$) of P-channel Tr. runs out before I_L reaches I_{LMIN} . The next cycle starts, and P-channel Tr. turns “ON” and N-channel Tr. turns “OFF”, which means I_L starts increasing from I_{LMIN} . This is called continuous current mode.

In the case of PWM mode, V_{OUT} is maintained by controlling ton . During the PWM mode, the oscillator frequency ($fosc$) is constantly maintained.

As shown in Figure 2., when the step-down DC/DC operation is constant, I_{LMIN} and I_{LMAX} during ton of P-channel Tr. is same as the P-channel Tr. during $toff$.

The current differential between I_{LMAX} and I_{LMIN} is described as ΔI .

$$\Delta I = I_{LMAX} - I_{LMIN} = V_{OUT} \times topen / L = (V_{IN} - V_{OUT}) \times ton / L \dots \dots \dots \text{Equation 1}$$

However,

$$T = 1 / fosc = ton + toff$$

$$\text{Duty (\%)} = ton / T \times 100 = ton \times fosc \times 100$$

$$topen \leq toff$$

In Equation 1, “ $V_{OUT} \times topen / L$ ” shows the amount of current change in “OFF” state. Also, “ $(V_{IN} - V_{OUT}) \times ton / L$ ” shows the amount of current change at “ON” state.

DISCONTINUOUS MODE AND CONTINUOUS MODE

As illustrated in Figure 3., when I_{OUT} is relatively small, $t_{open} < t_{off}$. In this case, the energy charged into L during t_{on} will be completely discharged during t_{off} , as a result, $I_{LMIN} = 0$. This is called discontinuous mode.

When I_{OUT} is gradually increased, eventually $t_{open} = t_{off}$ and when I_{OUT} is increased further, eventually $I_{LMIN} > 0$. This is called continuous mode.



Figure 3. Discontinuous Mode



Figure 4. Continuous Mode

In the continuous mode, the solution of Equation 1 is described as t_{onc} .

$$t_{onc} = T \times V_{OUT} / V_{IN} \dots\dots\dots \text{Equation 2}$$

When $t_{on} < t_{onc}$, it indicates discontinuous mode, and when $t_{on} \geq t_{onc}$, it indicates continuous mode.

FORCED PWM MODE

By setting the MODE pin to "H", the RP508x switches on/off at the fixed frequency to reduce noise even under the light load. When I_{OUT} is $\Delta I_L / 2$ or less, I_{LMIN} becomes less than 0. That is, the accumulated electricity in C_L is discharged through the IC side at I_L increase period from I_{LMIN} to "0" during t_{on} and at I_L decrease period from "0" to I_{LMIN} during t_{off} .



Forced PWM Mode

VFM MODE

By setting the MODE pin to "L", in low output current, the IC automatically switches into VFM mode in order to achieve high efficiency. In VFM mode, a value of t_{on} is determined by V_{IN} and V_{OUT} .

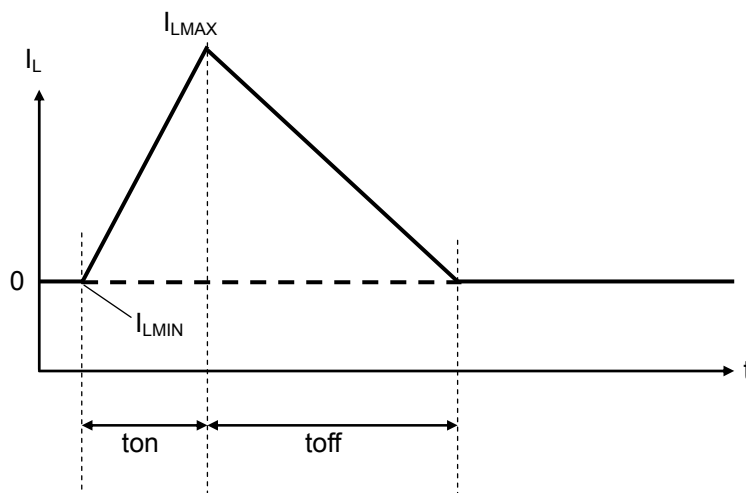

VFM Mode

OUTPUT CURRENT AND SELECTION OF EXTERNAL COMPONENTS

The following equations explain the relationship between output current and peripheral components used in the diagrams in *TYPICAL APPLICATIONS*.

Ripple Current P-P value is described as I_{RP} , ON resistance of P-channel Tr. is described as R_{ONP} , ON resistance of N-channel Tr. is described as R_{ONN} , and DC resistor of the inductor is described as R_L .

First, when P-channel Tr. is "ON", the following equation is satisfied.

$$V_{IN} = V_{OUT} + (R_{ONP} + R_L) \times I_{OUT} + L \times I_{RP} / t_{on} \dots\dots\dots \text{Equation 3}$$

Second, when P-channel Tr. is "OFF" (N-channel Tr. is "ON"), the following equation is satisfied.

$$L \times I_{RP} / t_{off} = R_{ONN} \times I_{OUT} + V_{OUT} + R_L \times I_{OUT} \dots\dots\dots \text{Equation 4}$$

Put Equation 4 into Equation 3 to solve ON duty of P-channel Tr. ($D_{ON} = t_{on} / (t_{off} + t_{on})$):

$$D_{ON} = (V_{OUT} + R_{ONN} \times I_{OUT} + R_L \times I_{OUT}) / (V_{IN} + R_{ONN} \times I_{OUT} - R_{ONP} \times I_{OUT}) \dots\dots\dots \text{Equation 5}$$

Ripple Current is described as follows:

$$I_{RP} = (V_{IN} - V_{OUT} - R_{ONP} \times I_{OUT} - R_L \times I_{OUT}) \times D_{ON} / f_{osc} / L \dots\dots\dots \text{Equation 6}$$

Peak current that flows through L, and L_x Tr. is described as follows:

$$I_{LXMAX} = I_{OUT} + I_{RP} / 2 \dots\dots\dots \text{Equation 7}$$

Consider I_{LXMAX} when setting conditions of input and output, as well as selecting the external components. The above calculation formulas are based on the ideal operation of the I_{CS} in continuous mode.

TIMING CHART

SOFT-START TIME

Starting-up with CE Pin

The IC starts to operate when the CE pin voltage (V_{CE}) exceeds the threshold voltage. The threshold voltage is preset between CE “H” input voltage (V_{CEH}) and CE “L” input voltage (V_{CEL}).

After the start-up of the IC, soft-start circuit starts to operate. Then, after a certain period of time, the reference voltage (V_{REF}) in the IC gradually increases up to the specified value.



Soft-start time starts when soft-start circuit is activated, and ends when the reference voltage reaches the specified voltage.

Soft start time is not always equal to the turn-on speed of the step-down DC/DC converter. Note that the turn-on speed could be affected by the power supply capacity, the output current, the inductance value and the C_{OUT} value.

Starting-up with Power Supply

After the power-on, when V_{IN} exceeds the UVLO released voltage (V_{UVLO2}), the IC starts to operate. Then, soft-start circuit starts to operate and after a certain period of time, V_{REF} gradually increases up to the specified value. Soft-start time starts when soft-start circuit is activated, and ends when V_{REF} reaches the specified voltage.

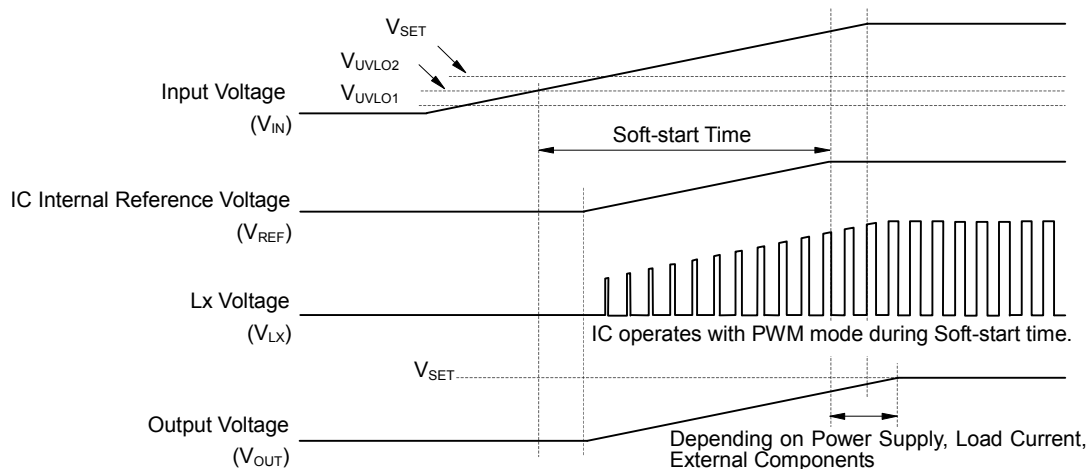

Note that the turn-on speed of V_{OUT} could be affected by the power supply capacity, the output current, the inductance value, the C_{OUT} value and the turn-on speed of V_{IN} determined by C_{IN} .

Under Voltage Lockout (UVLO) Circuit

If V_{IN} becomes lower than V_{SET} , the step-down DC/DC converter stops the switching operation and ON duty becomes 100%, and then V_{OUT} gradually drops according to V_{IN} .

If the V_{IN} becomes lower than the UVLO detector threshold (V_{UVLO1}), the UVLO circuit starts to operate, V_{REF} stops, and P-channel and N-channel built-in switch transistors turn "OFF". As a result, V_{OUT} drops according to the C_{OUT} capacitance value and the load.

To restart the operation, V_{IN} needs to be higher than V_{UVLO2} . The timing chart below shows the voltage shifts of V_{REF} , V_{LX} and V_{OUT} when V_{IN} value is varied.

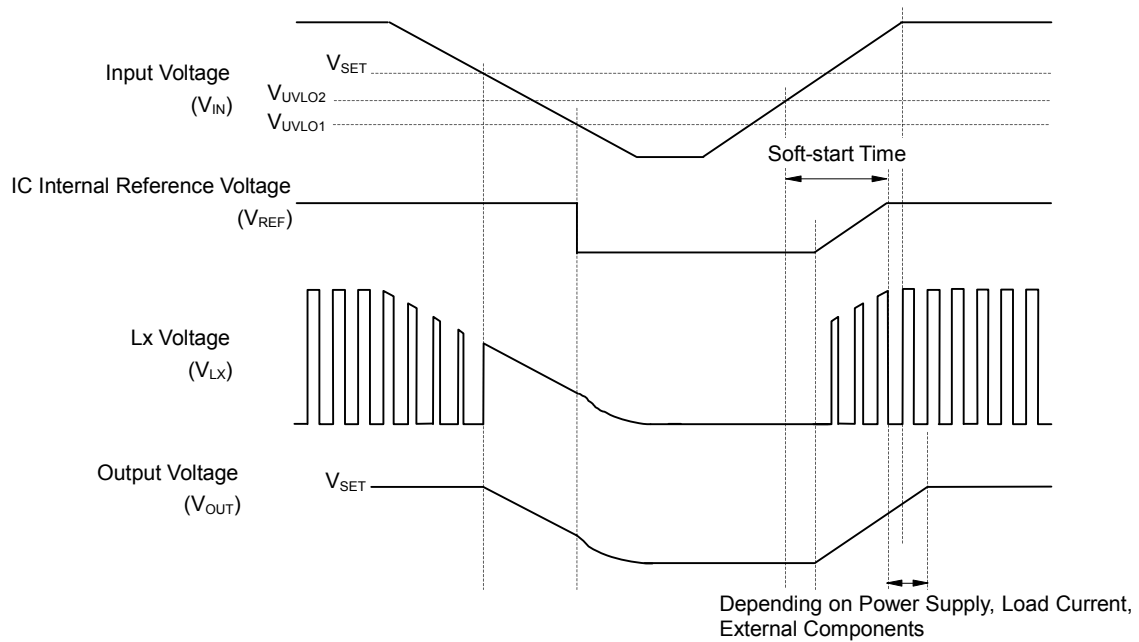

Falling edge (operating) and rising edge (releasing) waveforms of V_{OUT} could be affected by the initial voltage of C_{OUT} and the output current of V_{OUT} .

Over Current Protection Circuit

Over current protection circuit supervises the inductor peak current (the peak current flowing through P-channel Tr.) in each switching cycle. If the current exceeds the L_x current limit (I_{LxLIM}) of 1100 mA (Typ.), P-channel Tr. is turned off.

I_{LxLIM} could be easily affected by self-heating or ambient environment. If the V_{IN} drops dramatically or becomes unstable due to short-circuit, protection operation could be affected.

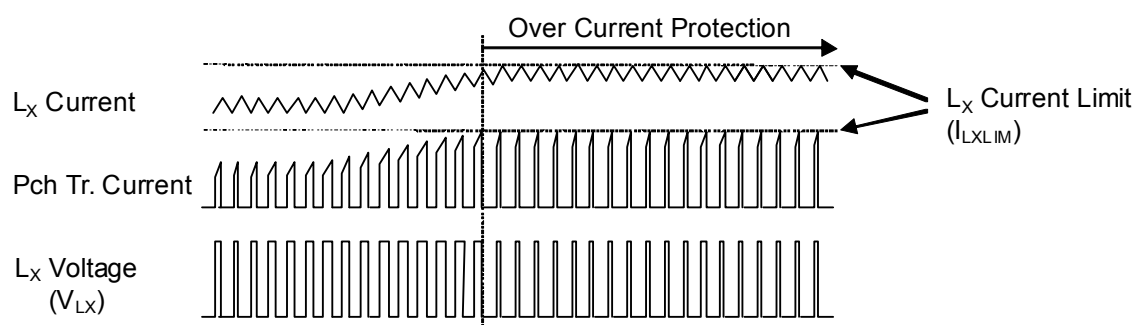

RP508x FEATURES

FAST FREQUENCY AND FAST RESPONSE



There are the following advantages when it operates at fast frequency (6 MHz).

- Inductance value can be reduced.
- The fluctuation of energy in one cycle is fast and small, as a result, the capacitance value of C_{OUT} can be also reduced.
- Small LC value reduced the feedback delay, then response frequency band can be wide and transient response is much improved compared with conventional line-up.

*1 Ripple is added and easy to detect and stabilize the system.

MAXIMUM FREQUENCY (6 MHz) LOCK



Switching frequency in order to become reference frequency (6 MHz), delay time is included the output voltage feedback loop and locked the frequency (6 MHz).

*2 The frequency goes faster and faster without this.

FREQUENCY CONTROL FOR MINIMUM ON/OFF TIME

Minimum on/off time/Minimum off time is set. (But 100% duty is available.) In the 6 MHz, based on the calculation of input/ output relation, on/off time can be calculated, and if it is not satisfy the minimum on time / minimum off time, the reference frequency must be reduced and switching frequency is reduced.

(Ex.) Min On Time (40 ns)

- ① $V_{IN} = 3.6\text{ V}$ $V_{OUT} = 1.0\text{ V}$
 $1/6\text{ MHz} \times 1.0\text{ V} / 3.6\text{ V} \approx 46\text{ ns} > \text{Min On Time} (= 40\text{ ns})$
 →6 MHz Switching OK
- ② $V_{IN} = 5.5\text{ V}$ $V_{OUT} = 1.0\text{ V}$
 $1/6\text{ MHz} \times 1.0\text{ V} / 5.5\text{ V} \approx 30\text{ ns} < \text{Min On Time} (= 40\text{ ns})$
 →It must be slow down from 6 MHz

LX Waveform



Cycle time becomes long in order to satisfy Min. on time. It is suitable with keeping the duty.

(Ex.) Min Off Time (40 ns)

- ① $V_{IN} = 5.0\text{ V}$ $V_{OUT} = 3.3\text{ V}$
 $1/6\text{ MHz} \times (1 - 3.3\text{ V} / 5.0\text{ V}) \approx 57\text{ ns} > \text{Min Off Time} (= 40\text{ ns})$
 →6 MHz Switching OK
- ② $V_{IN} = 4.2\text{ V}$ $V_{OUT} = 3.3\text{ V}$
 $1/6\text{ MHz} \times (1 - 3.3\text{ V} / 4.2\text{ V}) \approx 36\text{ ns} < \text{Min Off Time} (= 40\text{ ns})$
 →It must be slow down from 6 MHz

LX Waveform



Cycle time becomes long in order to satisfy Min. off time. It is suitable with keeping the duty.

PACKAGE INFORMATION

POWER DISSIPATION (DFN(PLP)1212-6F)

Power Dissipation (P_D) of the package is dependent on PCB material, layout, and environmental conditions. The following conditions are used in this measurement.

Measurement Conditions

JEDEC STD 51-7 Test Land Pattern	
Environment	Mounting on Board (Wind Velocity = 0 m/s)
Board Material	Glass Cloth Epoxy Plastic (4 Layers)
Board Dimensions	76.2 mm × 114.3 mm × 1.6 mm
Copper Ratio	Top side, Back side: 60 mm square, Approx. 10% 2nd, 3rd: Approx. 100%
Through-holes	φ 0.85 mm x 44 pcs

Measurement Result

($T_a = 25^\circ\text{C}$, $T_{j\text{max}} = 125^\circ\text{C}$)

JEDEC STD 51-7 Test Land Pattern	
Power Dissipation	666 mW
Thermal Resistance	$\Theta_{ja} = (125 - 25^\circ\text{C}) / 0.666 \text{ W} = 150^\circ\text{C/W}$
	$\Theta_{jc} = 28^\circ\text{C/W}$

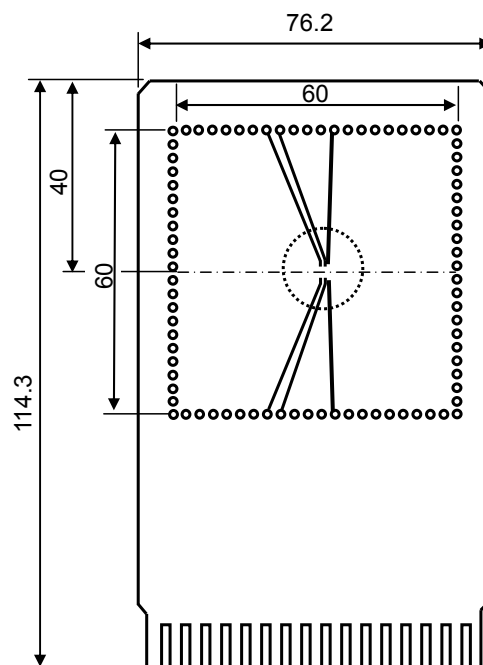
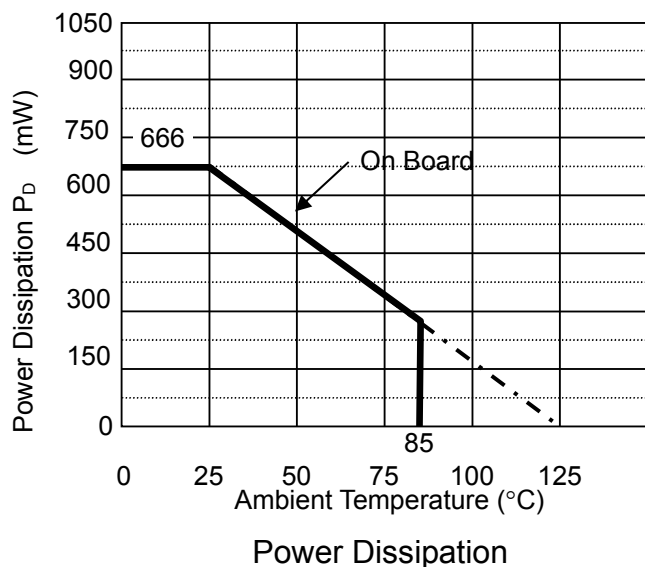

Measurement Board Pattern

○ IC Mount Area (Unit : mm)

PACKAGE DIMENSIONS (DFN(PLP)1212-6F)

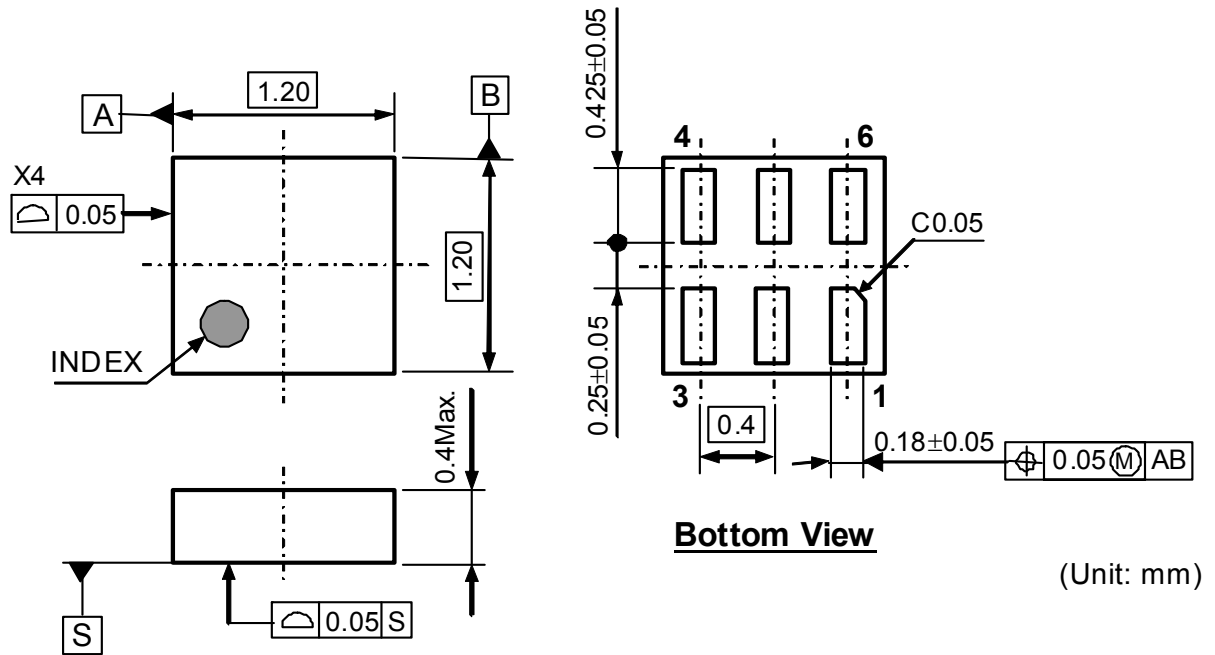

DFN (PLP) 1212-6F Package Dimensions

MARK SPECIFICATION (DFN(PLP)1212-6F)

- ①②: Product Code ... Refer to MARK SPECIFICATION TABLE (DFN(PLP)1212-6F)
- ③④: Lot Number ... Alphanumeric Serial Number

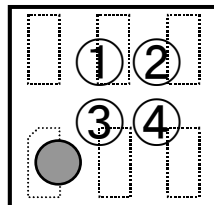

DFN (PLP) 1212-6F Mark Specification

MARK SPECIFICATION TABLE (DFN(PLP)1212-6F)

RP508Kxx1A		RP508Kxx1B	
Product Name	①②	Product Name	①②
RP508K081A	AA	RP508K081B	DA
RP508K091A	AC	RP508K091B	DC
RP508K101A	AE	RP508K101B	DE
RP508K101A5	AF	RP508K101B5	DF
RP508K111A	AG	RP508K111B	DG
RP508K121A	AJ	RP508K121B	DJ
RP508K121A5	AK	RP508K121B5	DK
RP508K131A	AL	RP508K131B	DL
RP508K131A5	AM	RP508K131B5	DM
RP508K141A	AN	RP508K141B	DN
RP508K151A	AR	RP508K151B	DR
RP508K161A	AT	RP508K161B	DT
RP508K171A	AV	RP508K171B	DV
RP508K181A	AX	RP508K181B	DX
RP508K191A	AZ	RP508K191B	DZ
RP508K201A	BB	RP508K201B	EB
RP508K211A	BD	RP508K211B	ED
RP508K221A	BF	RP508K221B	EF
RP508K231A	BH	RP508K231B	EH
RP508K241A	BK	RP508K241B	EK
RP508K251A	BM	RP508K251B	EM
RP508K261A	BP	RP508K261B	EP
RP508K271A	BS	RP508K271B	ES
RP508K281A	BU	RP508K281B	EU
RP508K291A	BW	RP508K291B	EW
RP508K301A	BY	RP508K301B	EY
RP508K311A	CA	RP508K311B	FA
RP508K321A	CC	RP508K321B	FC
RP508K331A	CE	RP508K331B	FE

TYPICAL CHARACTERISTICS

01) Output Voltage vs. Output Current

RP508K081x, $V_{OUT} = 0.8\text{ V}$

MODE = "L" PWM/VFM auto switching control

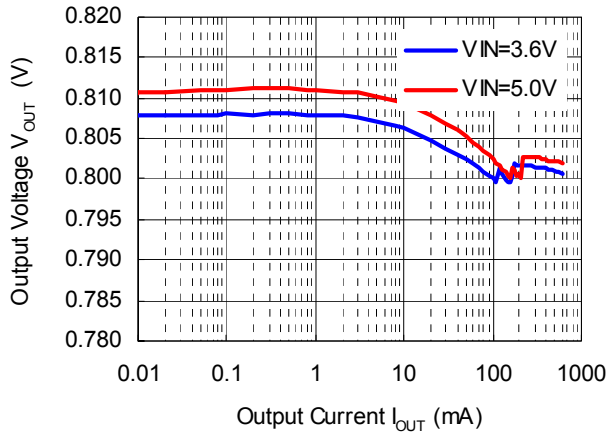

RP508K081x, $V_{OUT} = 0.8\text{ V}$

MODE = "H" forced PWM control

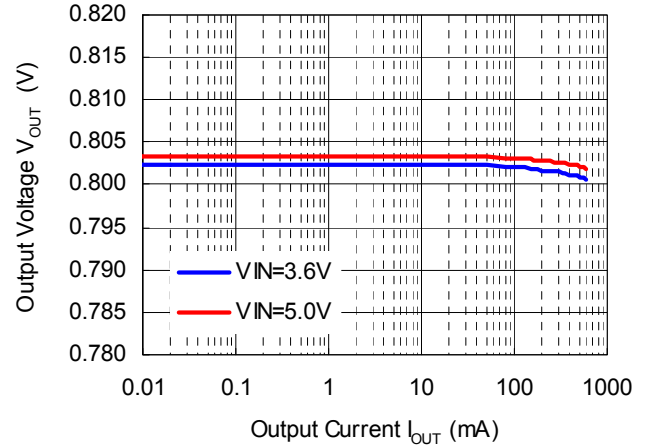

RP508K101x, $V_{OUT} = 1.0\text{ V}$

MODE = "L" PWM/VFM auto switching control

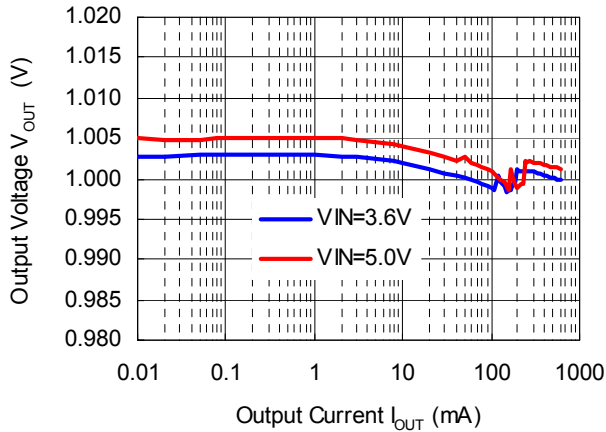

RP508K101x, $V_{OUT} = 1.0\text{ V}$

MODE = "H" forced PWM control

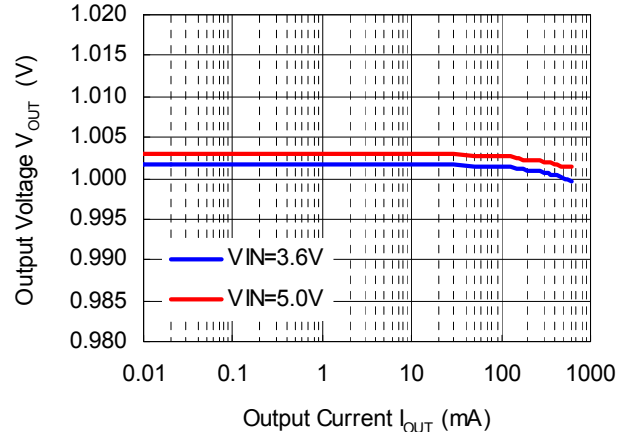

RP508K121x, $V_{OUT} = 1.2\text{ V}$

MODE = "L" PWM/VFM auto switching control

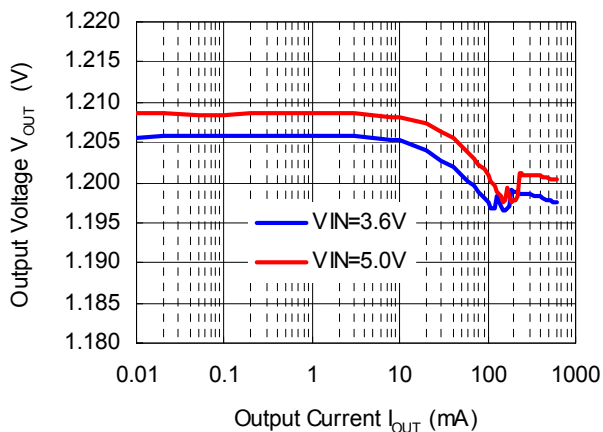

RP508K121x, $V_{OUT} = 1.2\text{ V}$

MODE = "H" forced PWM control

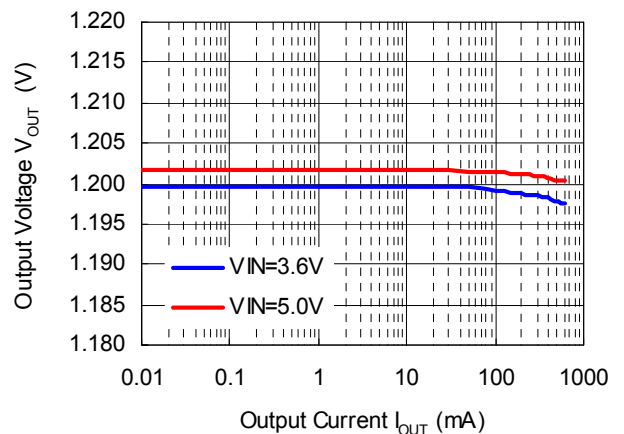

RP508K181x, $V_{OUT} = 1.8\text{ V}$
 MODE = "L" PWM/VFM auto switching control

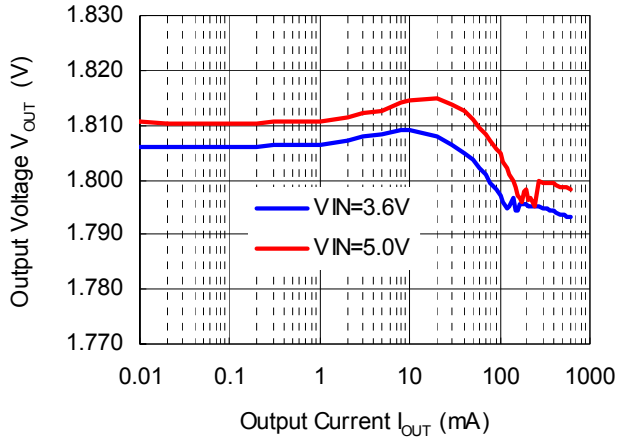

RP508K181x, $V_{OUT} = 1.8\text{ V}$
 MODE = "H" forced PWM control

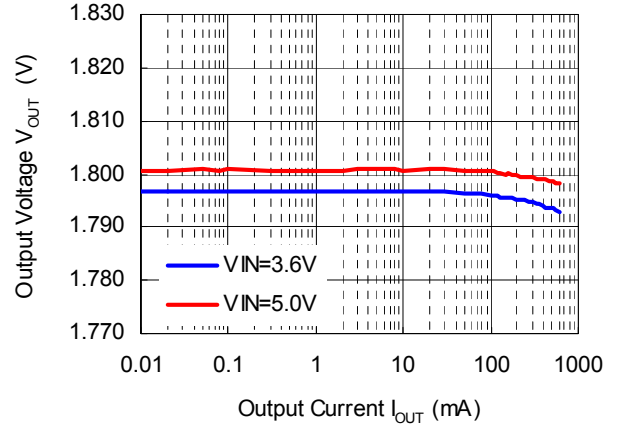

RP508K331x, $V_{OUT} = 3.3\text{ V}$
 MODE = "L" PWM/VFM auto switching control

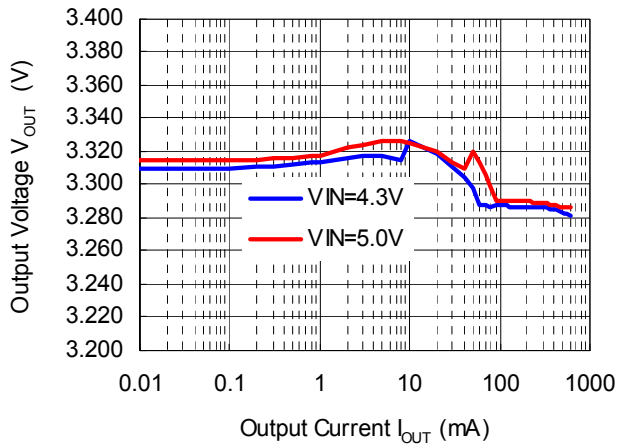

RP508K331x, $V_{OUT} = 3.3\text{ V}$
 MODE = "H" forced PWM control

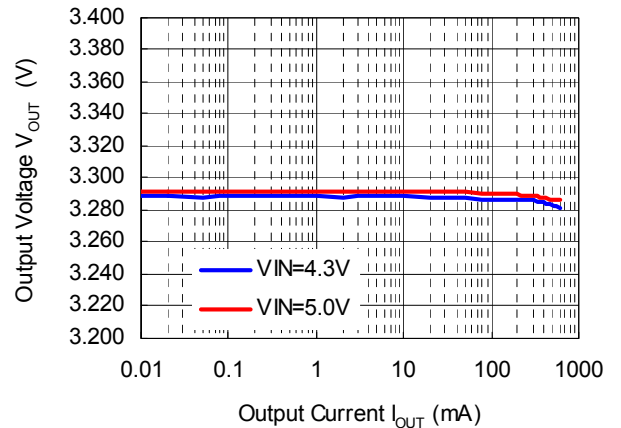

02) Output Voltage vs. Input Voltage

RP508K081x, $V_{OUT} = 0.8\text{ V}$
 MODE = "H" forced PWM control

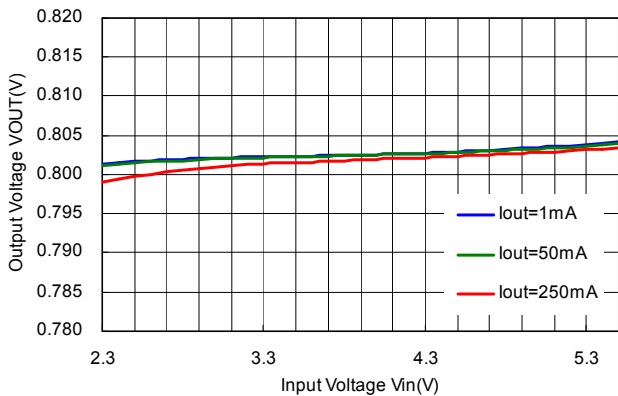

RP508K101x, $V_{OUT} = 1.0\text{ V}$
 MODE = "H" forced PWM control

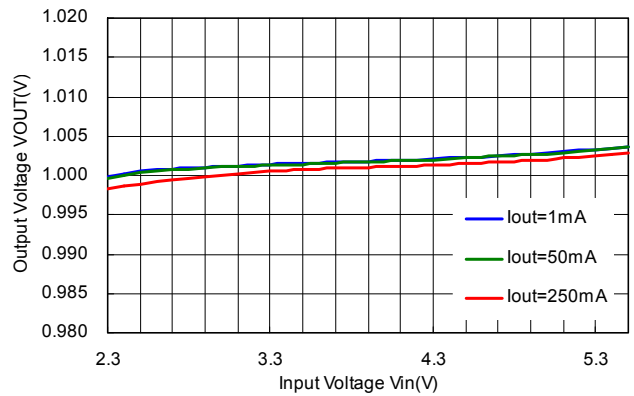

RP508K121x, $V_{OUT} = 1.2\text{ V}$
 MODE = "H" forced PWM control



RP508K181x, $V_{OUT} = 1.8\text{ V}$
 MODE = "H" forced PWM control

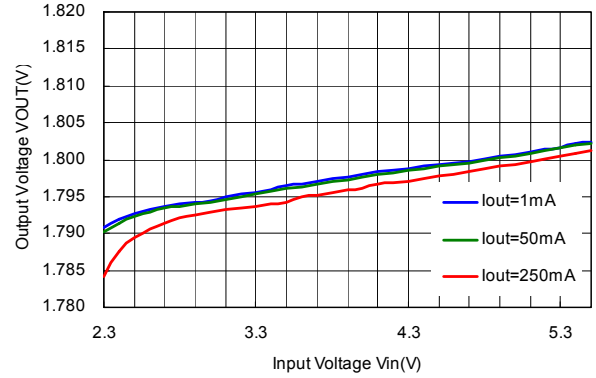

RP508K331x, $V_{OUT} = 3.3\text{ V}$
 MODE = "H" forced PWM control

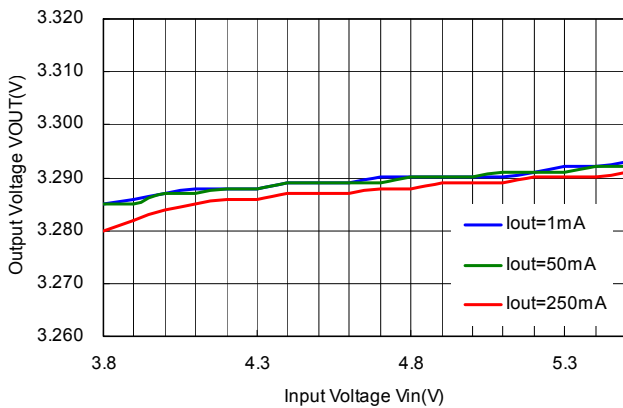

03) Output Voltage vs. Temperature

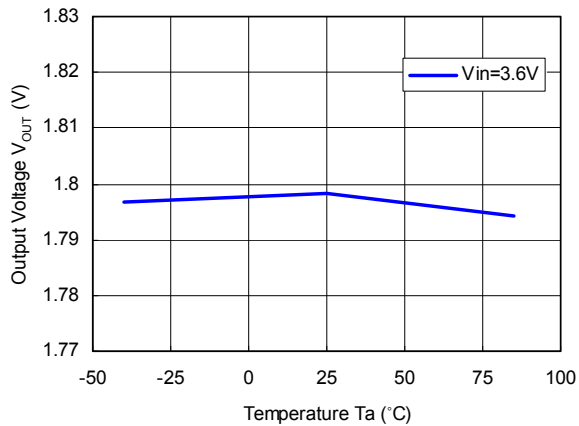

04) Efficiency vs. Output Current

RP508K081x, $V_{OUT} = 0.8\text{ V}$
 L = MIPSZ2012D0R5 (2012size_0.5 μH)

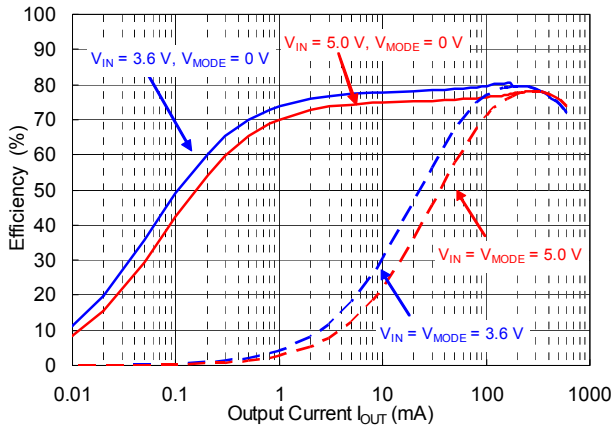

RP508K101x, $V_{OUT} = 1.0\text{ V}$
 L = MIPSZ2012D0R5 (2012size_0.5 μH)

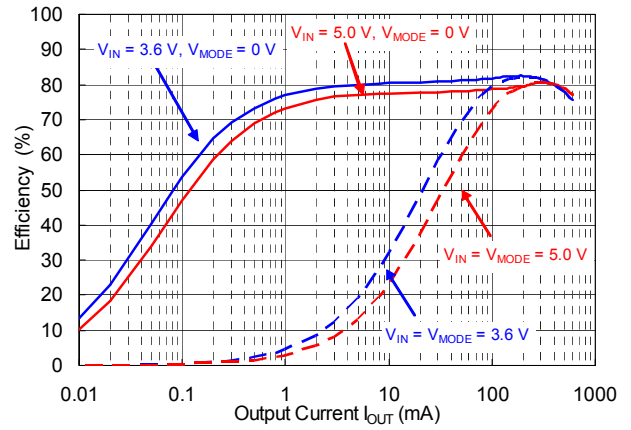

RP508K121x, $V_{OUT} = 1.2\text{ V}$
 L = MIPSZ2012D0R5 (2012size_0.5 μH)

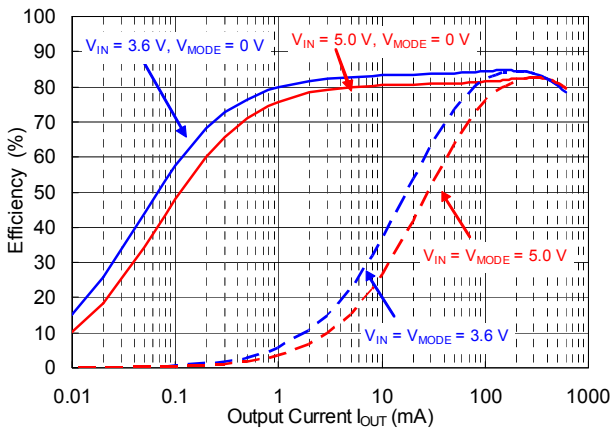

RP508K181x, $V_{OUT} = 1.8\text{ V}$
 L = MIPSZ2012D0R5 (2012size_0.5 μH)

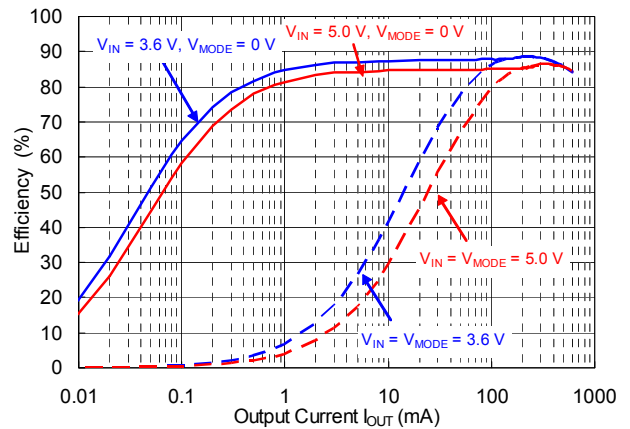

RP508K331x, $V_{OUT} = 3.3\text{ V}$
 L = MIPSZ2012D1R0 (2012size_1.0 μH)

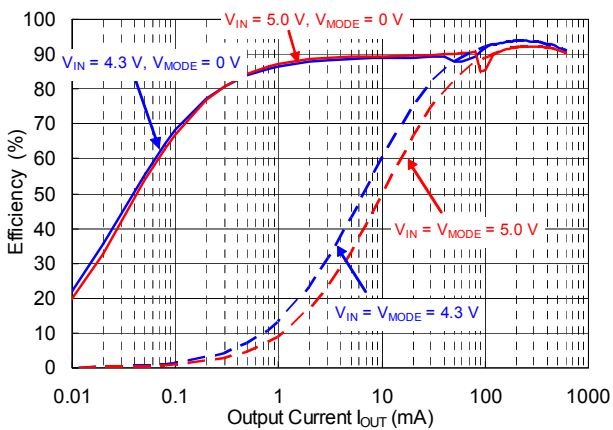

RP508K081x, $V_{OUT} = 0.8\text{ V}$
 L = MDT1608CHR47N (1608size_0.47 μH)



RP508K101x, $V_{OUT} = 1.0\text{ V}$
 L = MDT1608CHR47N (1608size_0.47 μH)

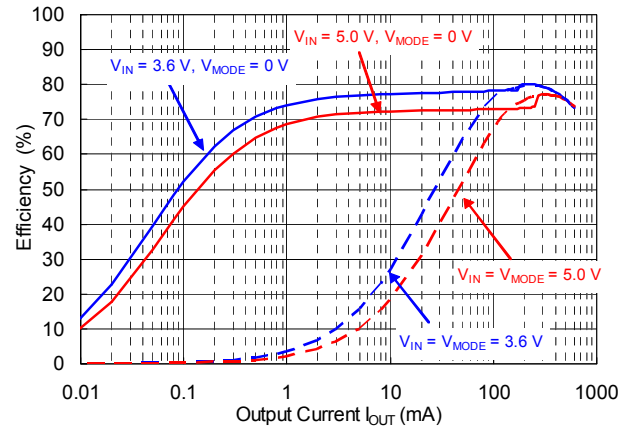

RP508K121x, $V_{OUT} = 1.2\text{ V}$
 L = MDT1608CHR47N (1608size_0.47 μH)

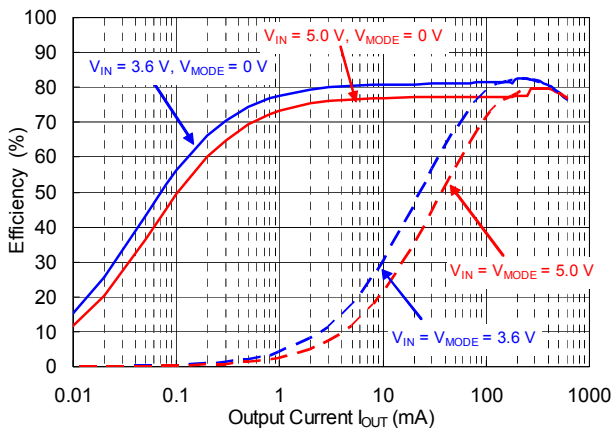

RP508K181x, $V_{OUT} = 1.8\text{ V}$
 L = MDT1608CHR47N (1608size_0.47 μH)

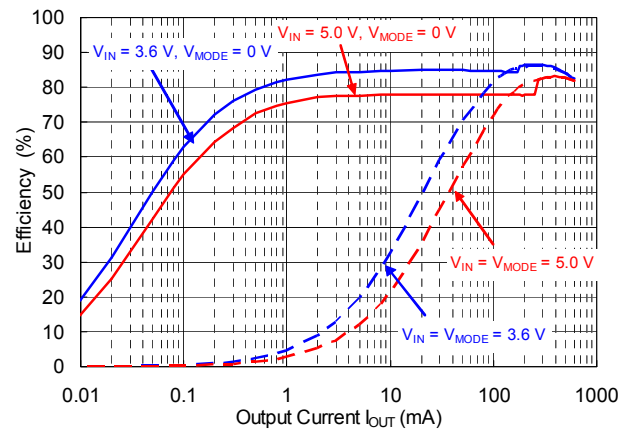

RP508K331x, $V_{OUT} = 3.3\text{ V}$
 L = MDT1608CH1R0N (1608size_1.0 μH)

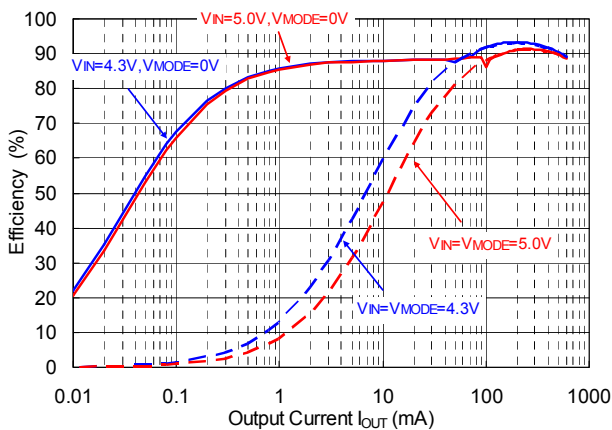

05) Supply Current vs. Temperature

RP508K181x, $V_{OUT} = 1.8\text{ V}$ ($V_{IN} = 5.5\text{ V}$)
 MODE = "L" PWM/VFM auto switching control

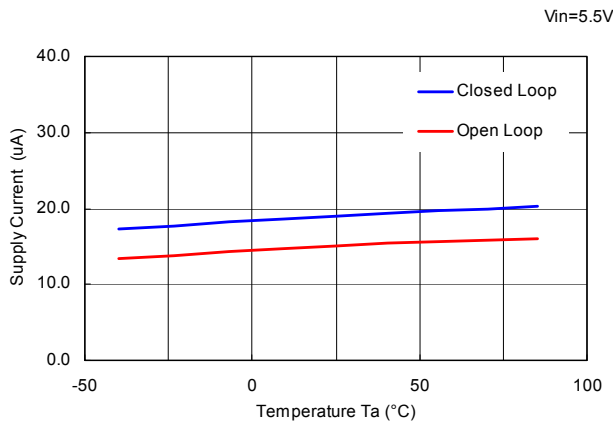

06) Supply Current vs. Input Voltage

RP508K181x, $V_{OUT} = 1.8\text{ V}$
 MODE = "L" PWM/VFM auto switching control

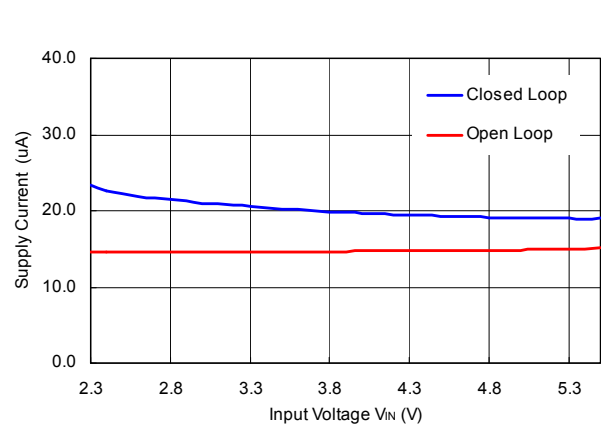

07) Output Voltage Waveform

RP508K081x, $V_{OUT} = 0.8\text{ V}$ ($V_{IN} = 3.6\text{ V}$)
 MODE = "L" PWM/VFM auto switching control

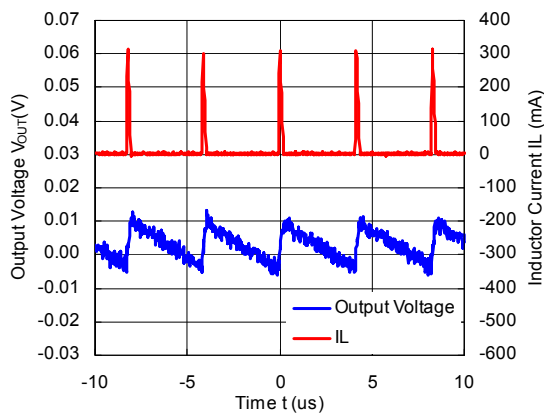

RP508K081x, $V_{OUT} = 0.8\text{ V}$ ($V_{IN} = 3.6\text{ V}$)
 MODE = "H" forced PWM control

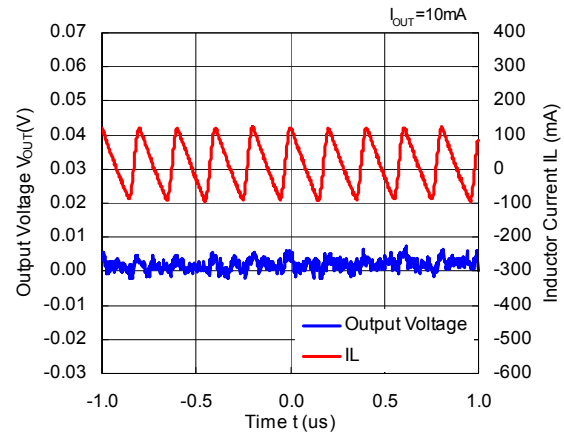

RP508K121x, $V_{OUT} = 1.2\text{ V}$ ($V_{IN} = 3.6\text{ V}$)
 MODE = "L" PWM/VFM auto switching control

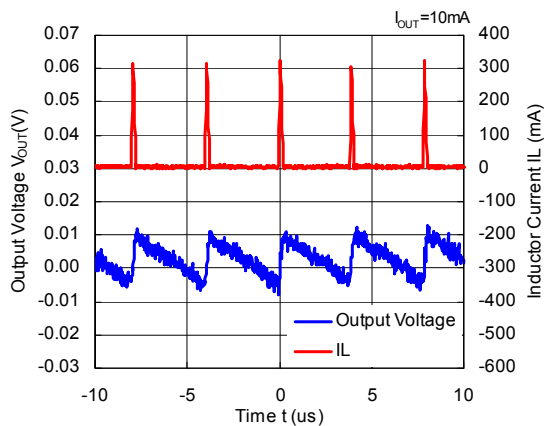

RP508K121x, $V_{OUT} = 1.2\text{ V}$ ($V_{IN} = 3.6\text{ V}$)
 MODE = "H" forced PWM control

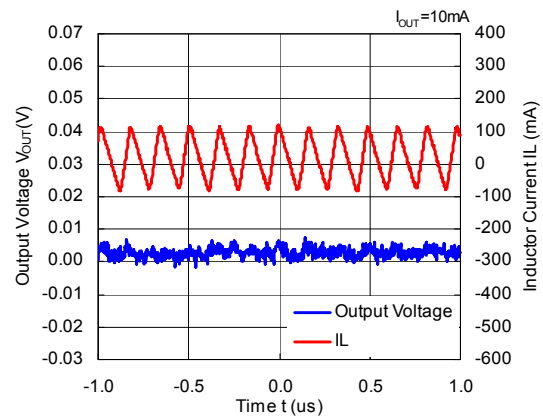

RP508K181x, $V_{OUT} = 1.8\text{ V}$ ($V_{IN} = 3.6\text{ V}$)
 MODE = "L" PWM/VFM auto switching control

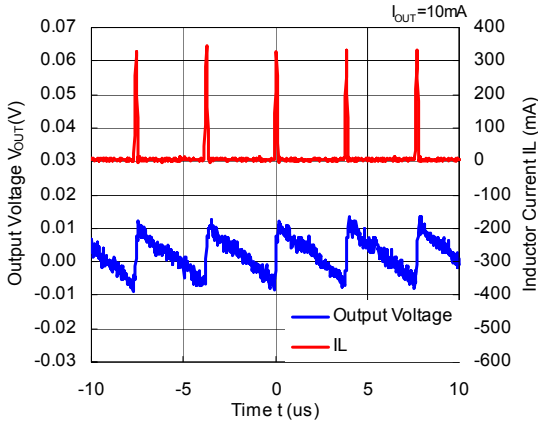

RP508K181x, $V_{OUT} = 1.8\text{ V}$ ($V_{IN} = 3.6\text{ V}$)
 MODE = "H" forced PWM control

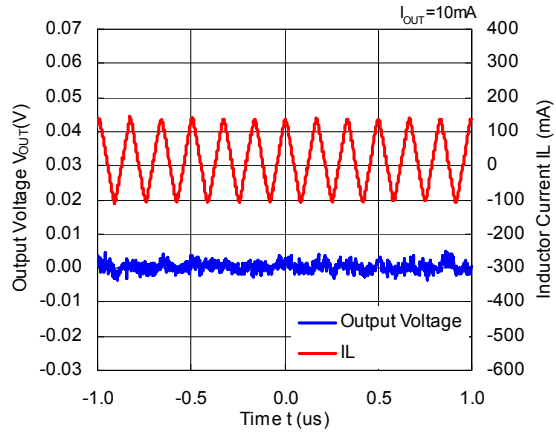

RP508K331x, $V_{OUT} = 3.3\text{ V}$ ($V_{IN} = 4.3\text{ V}$)
 MODE = "L" PWM/VFM auto switching control

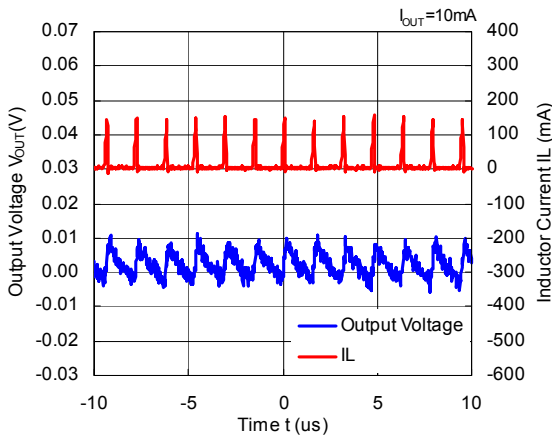

RP508K331x, $V_{OUT} = 3.3\text{ V}$ ($V_{IN} = 4.3\text{ V}$)
 MODE = "H" forced PWM control

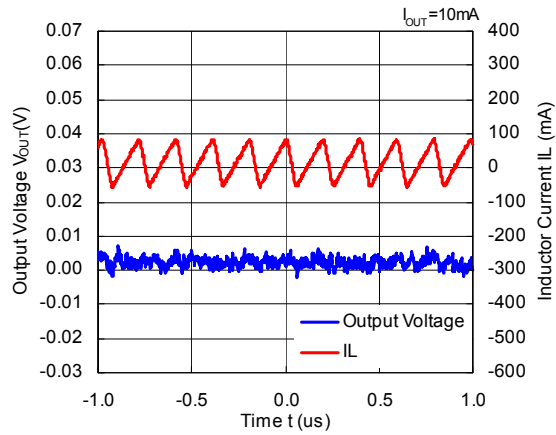

08) Frequency vs. Input Voltage

RP508K181x, $V_{OUT} = 1.8\text{ V}$
 MODE = "H" forced PWM control

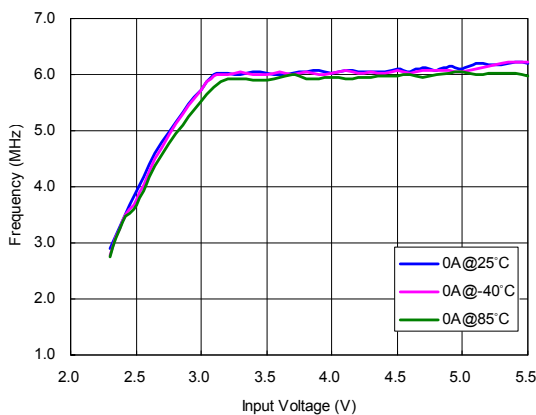

09) Frequency vs. Input Voltage with Various Output Currents

RP508K121x, $V_{OUT} = 1.2\text{ V}$
 MODE = "H" forced PWM control



RP508K181x, $V_{OUT} = 1.8\text{ V}$
 MODE = "H" forced PWM control

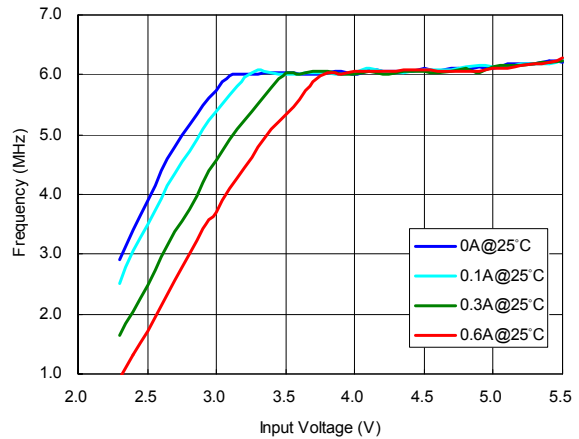

10) VFM Frequency vs. Output Current

RP508K121x, $V_{OUT} = 1.2\text{ V}$
 MODE = "L" PWM/VFM auto switching control

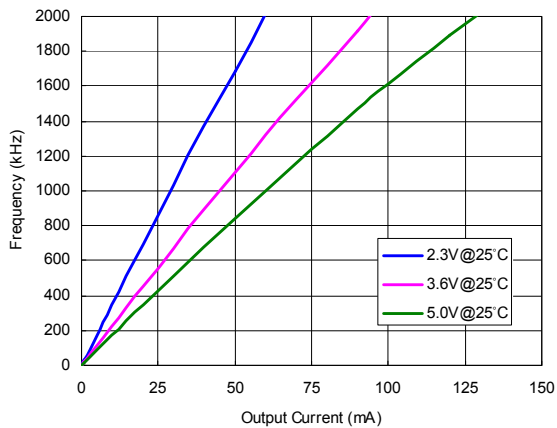

RP508K181x, $V_{OUT} = 1.8\text{ V}$
 MODE = "L" PWM/VFM auto switching control

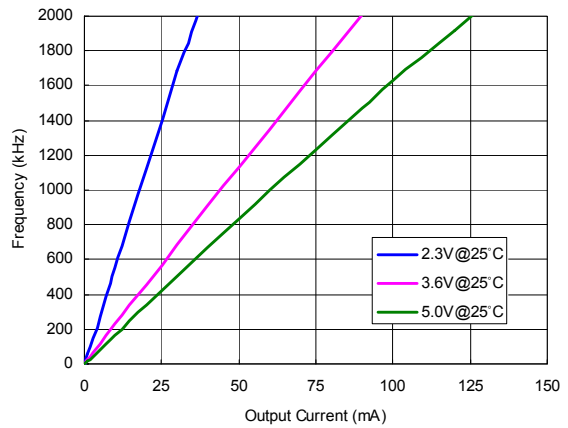

11) Soft-start Time vs. Temperature

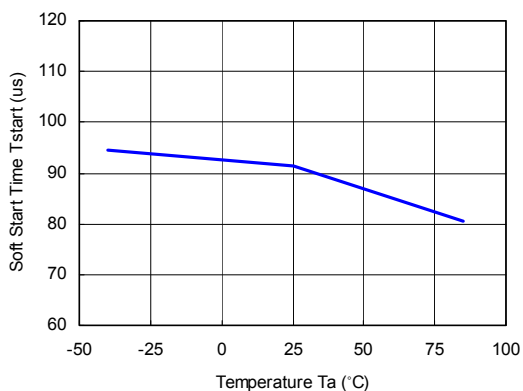

12) UVLO Detector Threshold/ Released Voltage vs. Temperature

UVLO Detector Threshold

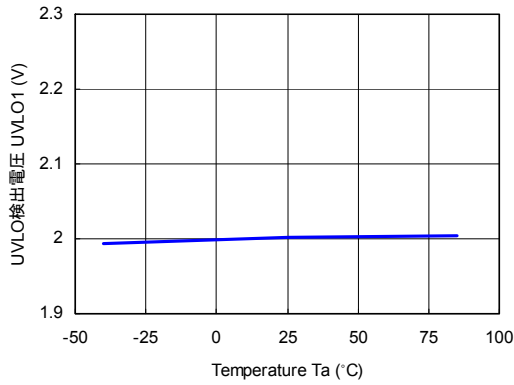

UVLO Release Voltage

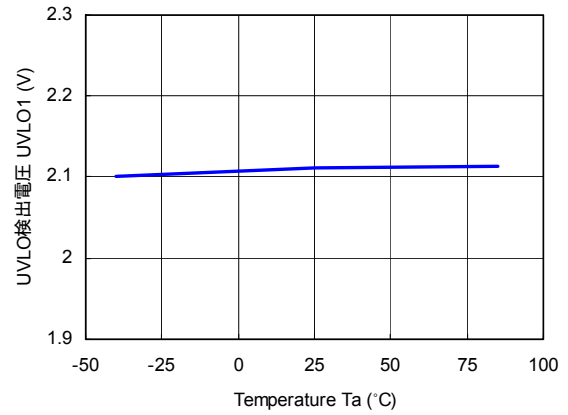

13) CE Input Voltage vs. Temperature

CE = "H" Input Voltage (VIN = 5.5 V)

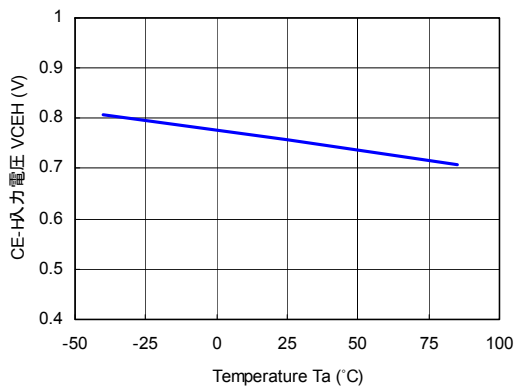

CE = "H" Input Voltage (VIN = 2.3 V)

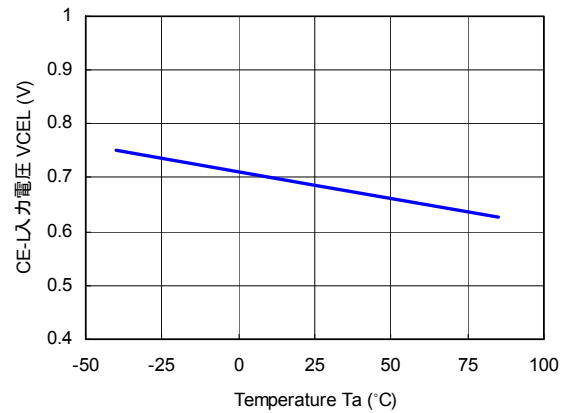

14) Lx Current Limit vs. Temperature

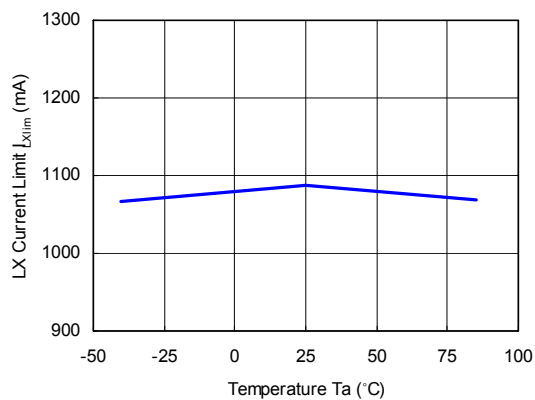

15) Standby Current vs. Temperature

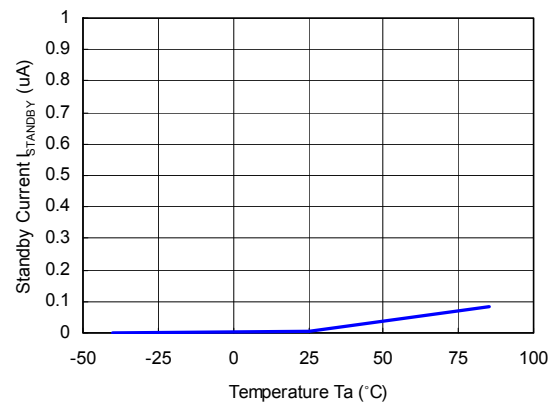

16) Nch Transistor On Resistance vs. Temperature 17) Pch Transistor On Resistance vs. Temperature

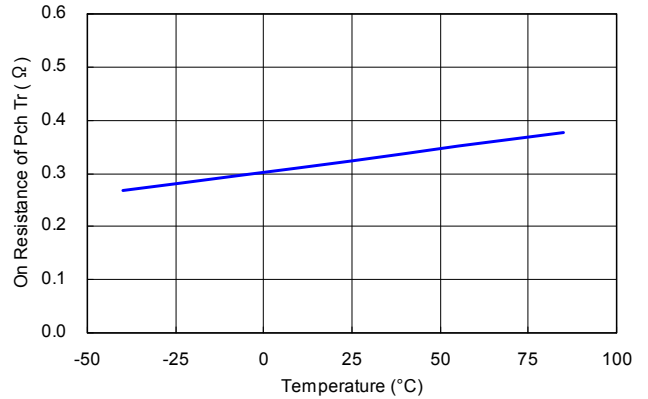
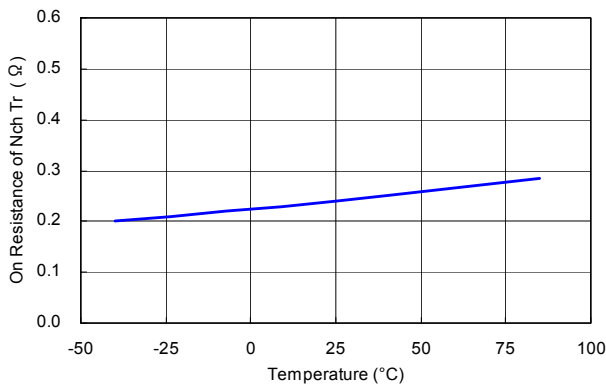

18) Load Transient Response (C_{OUT} = 4.7 μF, C1005X5R0J475M)

RP508K081x (V_{IN} = 3.6 V, V_{OUT} = 0.8 V)
 L = MIPSZ2012D0R5 (2012size_0.5 μH)
 MODE = "H" forced PWM control

RP508K081x (V_{IN} = 3.6 V, V_{OUT} = 0.8 V)
 L = MIPSZ2012D0R5 (2012size_0.5 μH)
 MODE = "H" forced PWM control

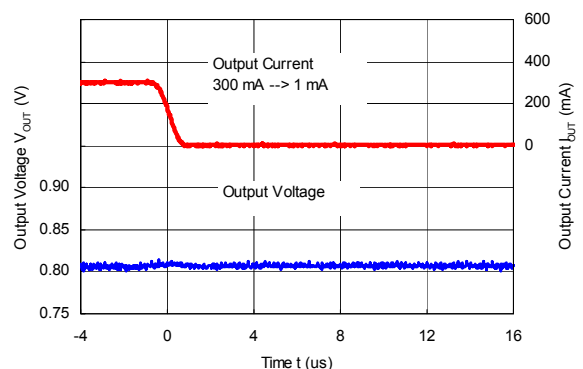
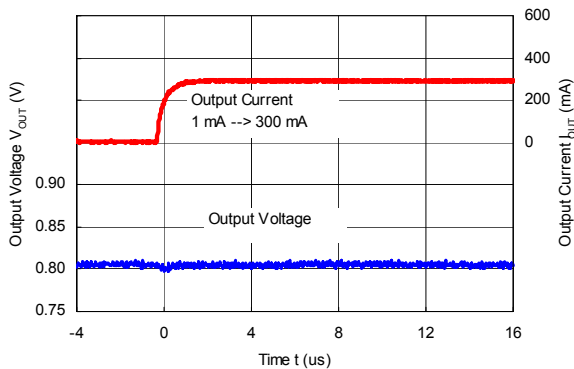

RP508K081x (V_{IN} = 3.6 V, V_{OUT} = 0.8 V)
 L = MIPSZ2012D0R5 (2012size_0.5 μH)
 MODE = "H" forced PWM control

RP508K081x (V_{IN} = 3.6 V, V_{OUT} = 0.8 V)
 L = MIPSZ2012D0R5 (2012size_0.5 μH)
 MODE = "H" forced PWM control

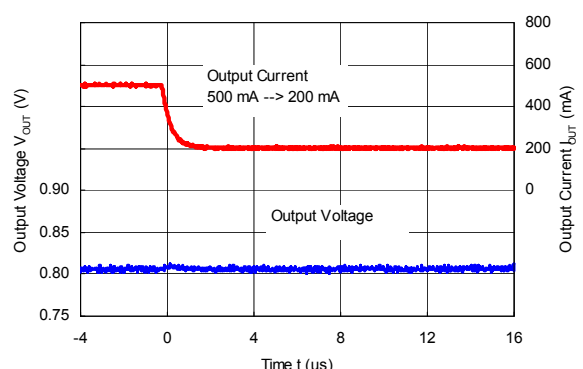
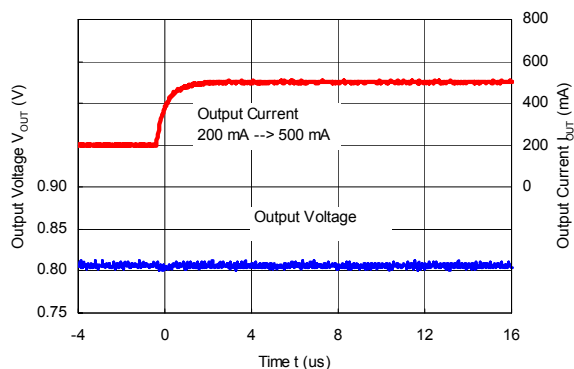

RP508K121x ($V_{IN} = 3.6\text{ V}$, $V_{OUT} = 1.2\text{ V}$)
 L = MIPSZ2012D0R5 (2012size_0.5 μH)
 MODE = "H" forced PWM control

RP508K121x ($V_{IN} = 3.6\text{ V}$, $V_{OUT} = 1.2\text{ V}$)
 L = MIPSZ2012D0R5 (2012size_0.5 μH)
 MODE = "H" forced PWM control

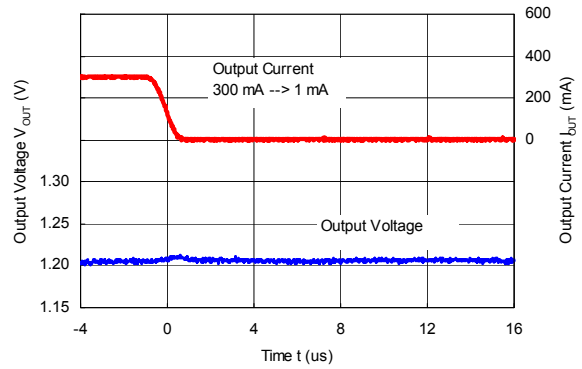
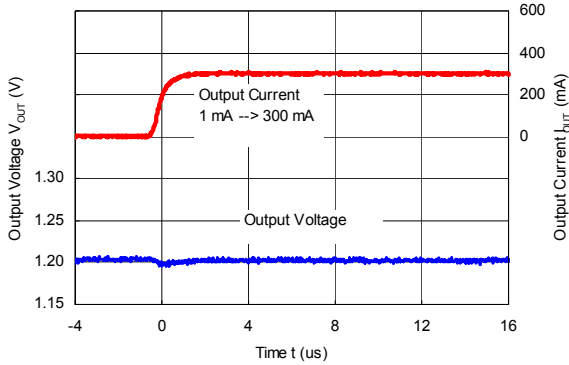

RP508K121x ($V_{IN} = 3.6\text{ V}$, $V_{OUT} = 1.2\text{ V}$)
 L = MIPSZ2012D0R5 (2012size_0.5 μH)
 MODE = "H" forced PWM control

RP508K121x ($V_{IN} = 3.6\text{ V}$, $V_{OUT} = 1.2\text{ V}$)
 L = MIPSZ2012D0R5 (2012size_0.5 μH)
 MODE = "H" forced PWM control

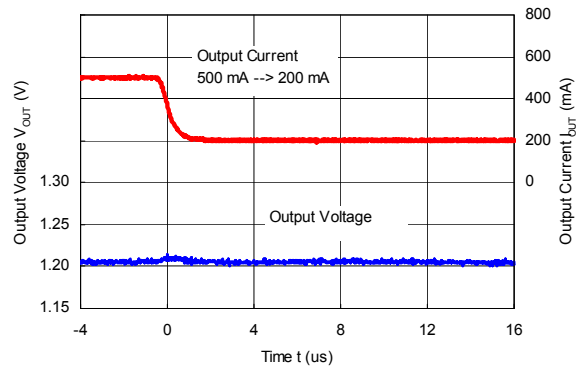
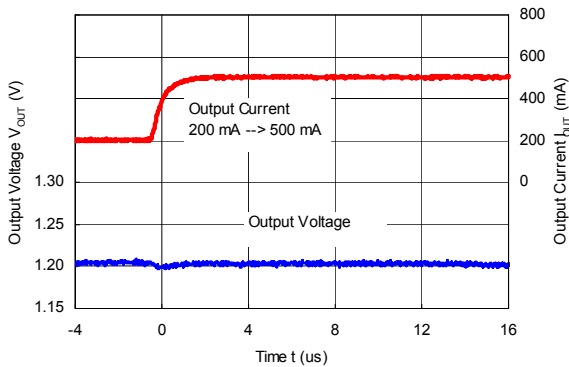

RP508K181x ($V_{IN} = 3.6\text{ V}$, $V_{OUT} = 1.8\text{ V}$)
 L = MIPSZ2012D0R5 (2012size_0.5 μH)
 MODE = "H" forced PWM control

RP508K181x ($V_{IN} = 3.6\text{ V}$, $V_{OUT} = 1.8\text{ V}$)
 L = MIPSZ2012D0R5 (2012size_0.5 μH)
 MODE = "H" forced PWM control

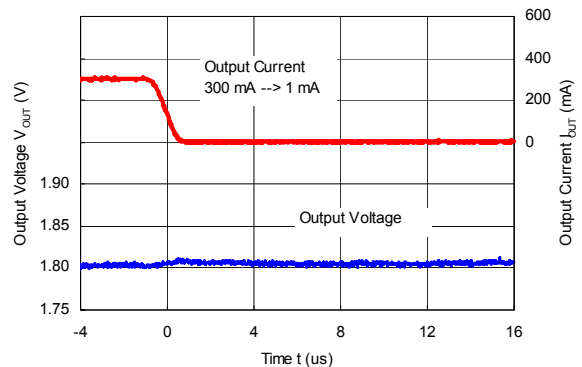
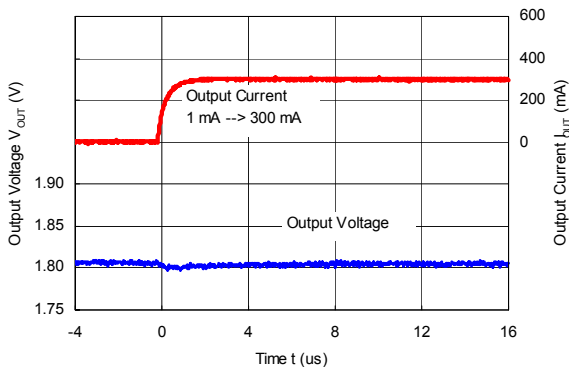

RP508K181x ($V_{IN} = 3.6\text{ V}$, $V_{OUT} = 1.8\text{ V}$)
 L = MIPSZ2012D0R5 (2012size_0.5 μH)
 MODE = "H" forced PWM control

RP508K181x ($V_{IN} = 3.6\text{ V}$, $V_{OUT} = 1.8\text{ V}$)
 L = MIPSZ2012D0R5 (2012size_0.5 μH)
 MODE = "H" forced PWM control

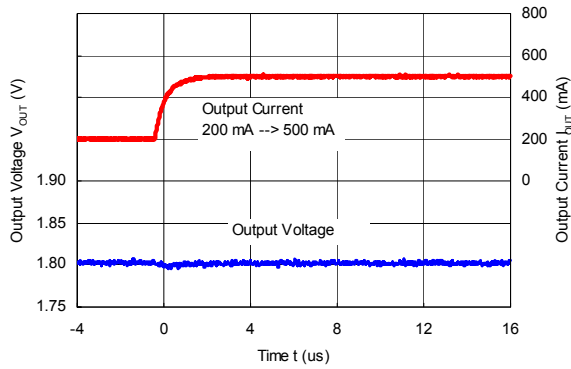

RP508K331x ($V_{IN} = 5.0\text{ V}$, $V_{OUT} = 3.3\text{ V}$)
 L = MIPSZ2012D1R0 (2012size_1.0 μH)
 MODE = "H" forced PWM control

RP508K331x ($V_{IN} = 5.0\text{ V}$, $V_{OUT} = 3.3\text{ V}$)
 L = MIPSZ2012D1R0 (2012size_1.0 μH)
 MODE = "H" forced PWM control

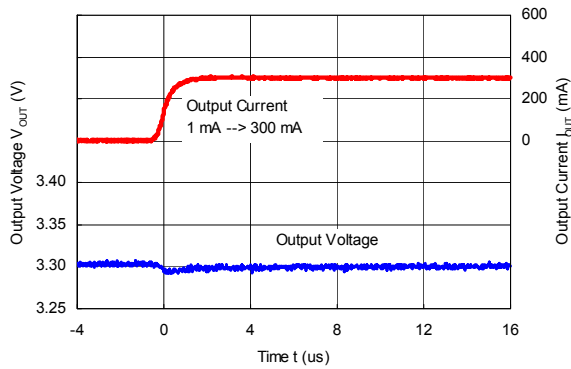

RP508K331x ($V_{IN} = 5.0\text{ V}$, $V_{OUT} = 3.3\text{ V}$)
 L = MIPSZ2012D1R0 (2012size_1.0 μH)
 MODE = "H" forced PWM control

RP508K331x ($V_{IN} = 5.0\text{ V}$, $V_{OUT} = 3.3\text{ V}$)
 L = MIPSZ2012D1R0 (2012size_1.0 μH)
 MODE = "H" forced PWM control

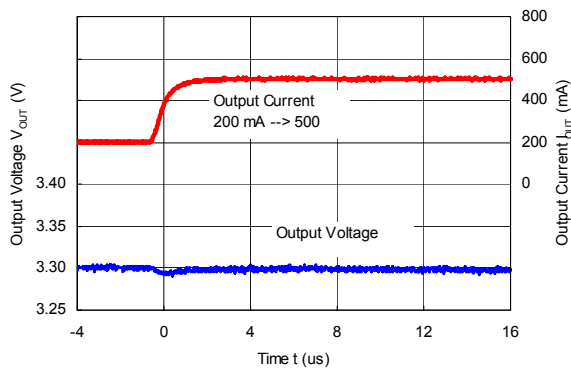

Load Transient Response ($C_{OUT} = 4.7\mu F, C1005X5R0J475M$)

RP508K081x ($V_{IN} = 3.6 V, V_{OUT} = 0.8 V$)
 L = MIPSZ2012D0R5 (2012size_0.5 μH)
 MODE = "L" PWM/VFM auto switching control

RP508K081x ($V_{IN} = 3.6 V, V_{OUT} = 0.8 V$)
 L = MIPSZ2012D0R5 (2012size_0.5 μH)
 MODE = "L" PWM/VFM auto switching control



RP508K121x ($V_{IN} = 3.6 V, V_{OUT} = 1.2 V$)
 L = MIPSZ2012D0R5 (2012size_0.5 μH)
 MODE = "L" PWM/VFM auto switching control

RP508K121x ($V_{IN} = 3.6 V, V_{OUT} = 1.2 V$)
 L = MIPSZ2012D0R5 (2012size_0.5 μH)
 MODE = "L" PWM/VFM auto switching control



RP508K181x ($V_{IN} = 3.6 V, V_{OUT} = 1.8 V$)
 L = MIPSZ2012D0R5 (2012size_0.5 μH)
 MODE = "L" PWM/VFM auto switching control

RP508K181x ($V_{IN} = 3.6 V, V_{OUT} = 1.8 V$)
 L = MIPSZ2012D0R5 (2012size_0.5 μH)
 MODE = "L" PWM/VFM auto switching control



RP508K331x ($V_{IN} = 5.0\text{ V}$, $V_{OUT} = 3.3\text{ V}$)
 L = MIPSZ2012D1R0 (2012size_1.0 μH)
 MODE = "L" PWM/VFM auto switching control

RP508K331x ($V_{IN} = 5.0\text{ V}$, $V_{OUT} = 3.3\text{ V}$)
 L = MIPSZ2012D1R0 (2012size_1.0 μH)
 MODE = "L" PWM/VFM auto switching control

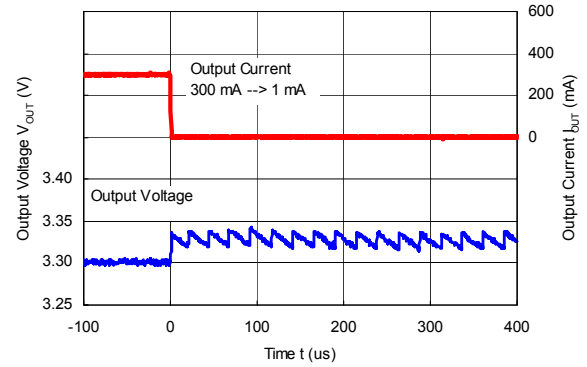
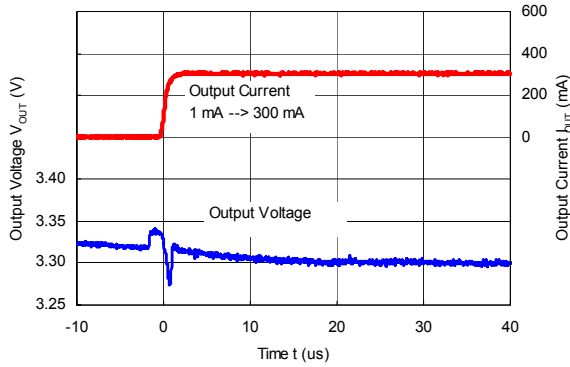

Load Transient Response ($C_{OUT} = 4.7\ \mu\text{F}$, C1005X5R0J475M)

RP508K081x ($V_{IN} = 3.6\text{ V}$, $V_{OUT} = 0.8\text{ V}$)
 L = MDT1608CHR47N (1608size_0.47 μH)
 MODE = "H" forced PWM control

RP508K081x ($V_{IN} = 3.6\text{ V}$, $V_{OUT} = 0.8\text{ V}$)
 L = MDT1608CHR47N (1608size_0.47 μH)
 MODE = "H" forced PWM control

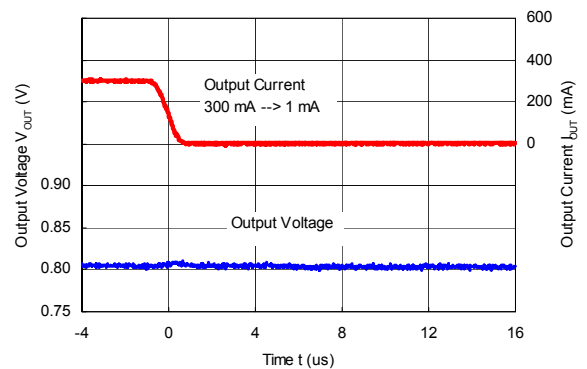
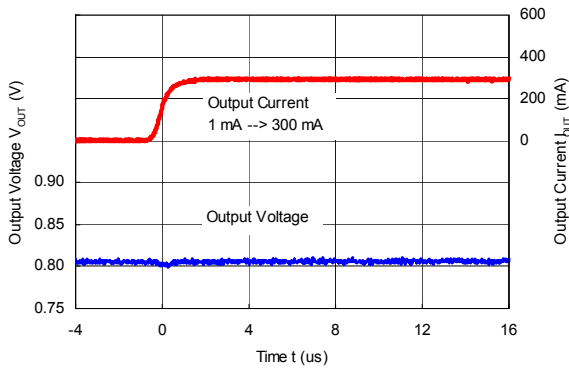

RP508K081x ($V_{IN} = 3.6\text{ V}$, $V_{OUT} = 0.8\text{ V}$)
 L = MDT1608CHR47N (1608size_0.47 μH)
 MODE = "H" forced PWM control

RP508K081x ($V_{IN} = 3.6\text{ V}$, $V_{OUT} = 0.8\text{ V}$)
 L = MDT1608CHR47N (1608size_0.47 μH)
 MODE = "H" forced PWM control

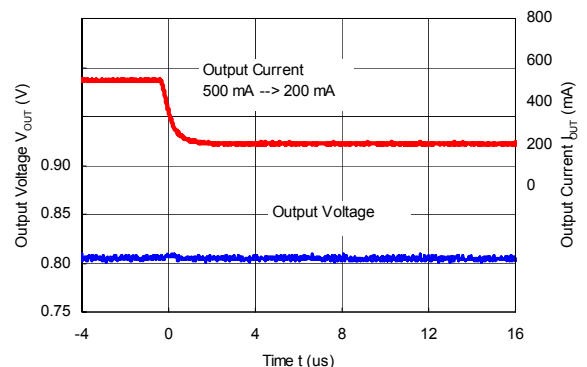
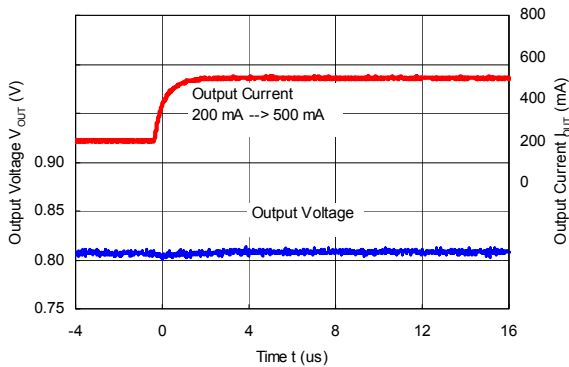

RP508K121x ($V_{IN} = 3.6\text{ V}$, $V_{OUT} = 1.2\text{ V}$)
 L = MDT1608CHR47N (1608size_0.47 μH)
 MODE = "H" forced PWM control

RP508K121x ($V_{IN} = 3.6\text{ V}$, $V_{OUT} = 1.2\text{ V}$)
 L = MDT1608CHR47N (1608size_0.47 μH)
 MODE = "H" forced PWM control

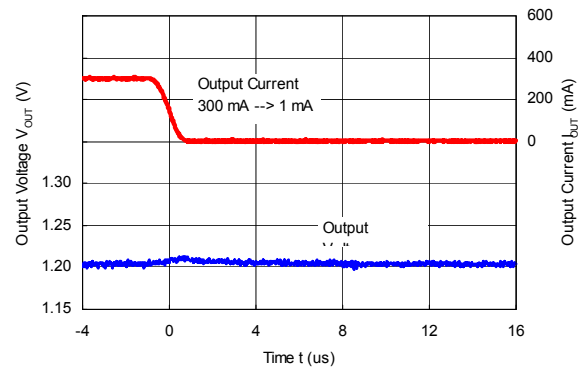
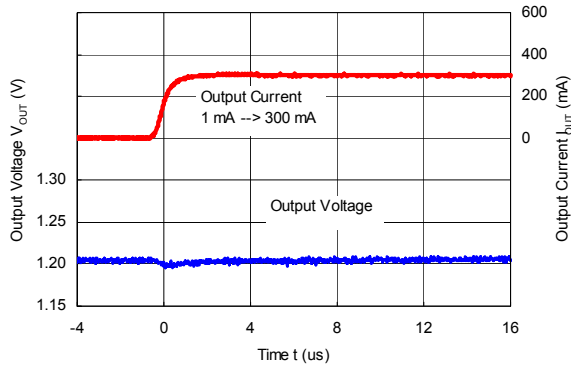

RP508K121x ($V_{IN} = 3.6\text{ V}$, $V_{OUT} = 1.2\text{ V}$)
 L = MDT1608CHR47N (1608size_0.47 μH)
 MODE = "H" forced PWM control

RP508K121x ($V_{IN} = 3.6\text{ V}$, $V_{OUT} = 1.2\text{ V}$)
 L = MDT1608CHR47N (1608size_0.47 μH)
 MODE = "H" forced PWM control

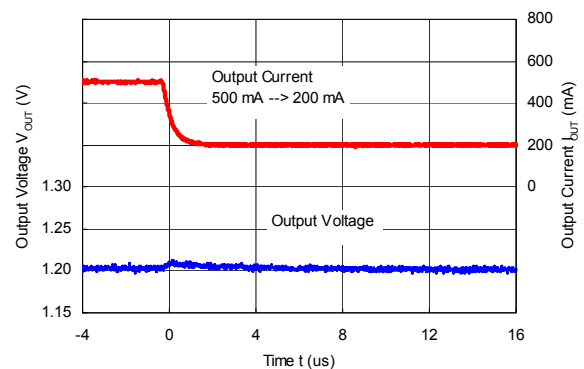
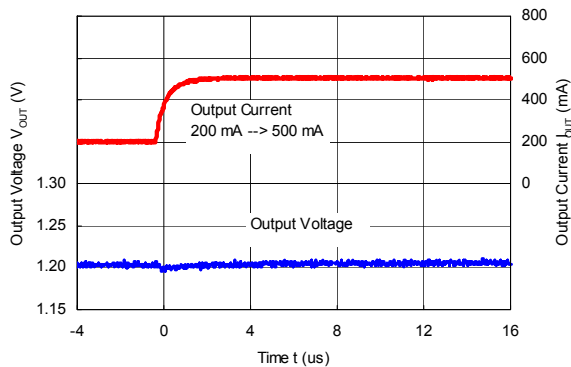

RP508K181x ($V_{IN} = 3.6\text{ V}$, $V_{OUT} = 1.8\text{ V}$)
 L = MDT1608CHR47N (1608size_0.47 μH)
 MODE = "H" forced PWM control

RP508K181x ($V_{IN} = 3.6\text{ V}$, $V_{OUT} = 1.8\text{ V}$)
 L = MDT1608CHR47N (1608size_0.47 μH)
 MODE = "H" forced PWM control

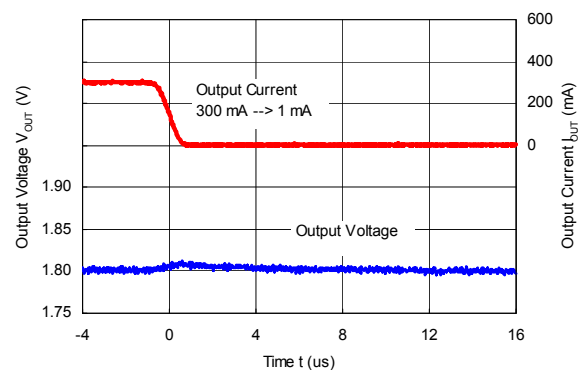
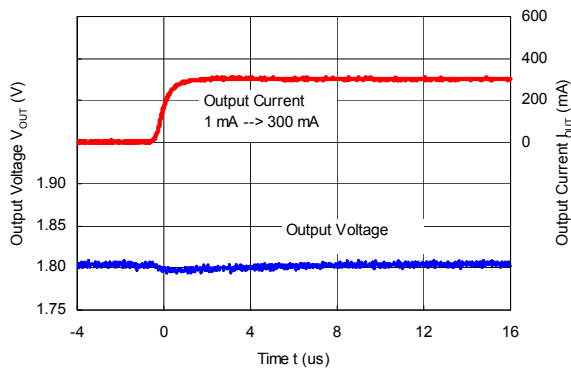

RP508K181x ($V_{IN} = 3.6\text{ V}$, $V_{OUT} = 1.8\text{ V}$)
 L = MDT1608CHR47N (1608size_0.47 μH)
 MODE = "H" forced PWM control

RP508K181x ($V_{IN} = 3.6\text{ V}$, $V_{OUT} = 1.8\text{ V}$)
 L = MDT1608CHR47N (1608size_0.47 μH)
 MODE = "H" forced PWM control

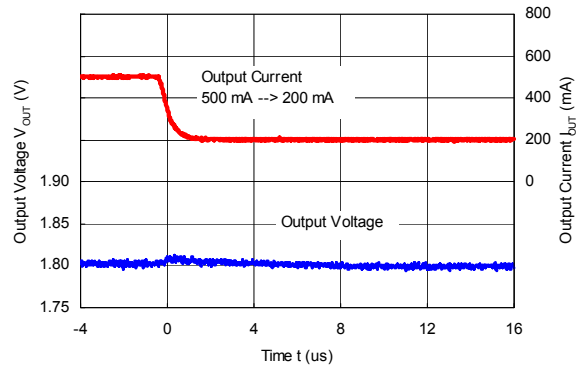
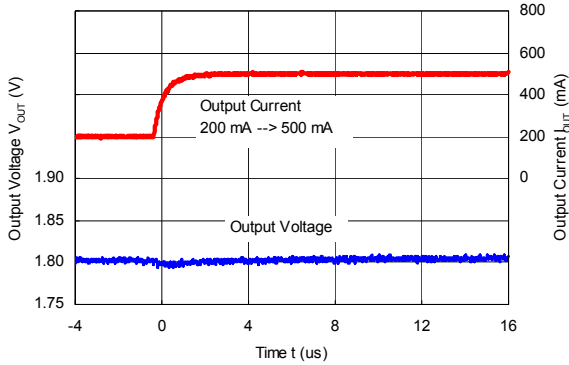

RP508K331x ($V_{IN} = 5.0\text{ V}$, $V_{OUT} = 3.3\text{ V}$)
 L = MDT1608CH1R0N (1608size_1.0 μH)
 MODE = "H" forced PWM control

RP508K331x ($V_{IN} = 5.0\text{ V}$, $V_{OUT} = 3.3\text{ V}$)
 L = MDT1608CH1R0N (1608size_1.0 μH)
 MODE = "H" forced PWM control

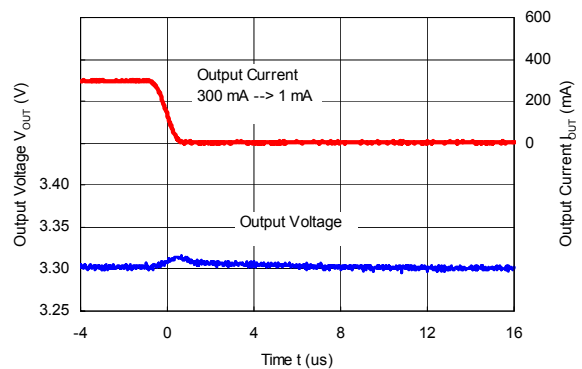
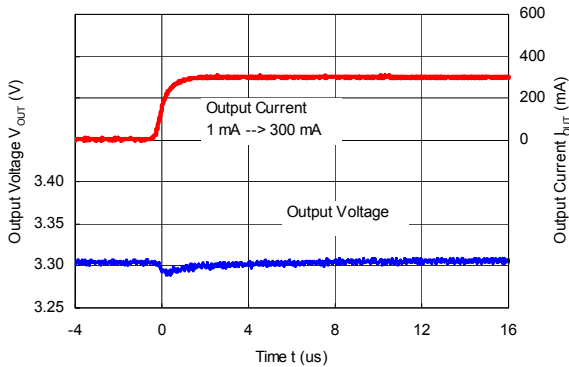

RP508K331x ($V_{IN} = 5.0\text{ V}$, $V_{OUT} = 3.3\text{ V}$)
 L = MDT1608CH1R0N (1608size_1.0 μH)
 MODE = "H" forced PWM control

RP508K331x ($V_{IN} = 5.0\text{ V}$, $V_{OUT} = 3.3\text{ V}$)
 L = MDT1608CH1R0N (1608size_1.0 μH)
 MODE = "H" forced PWM control

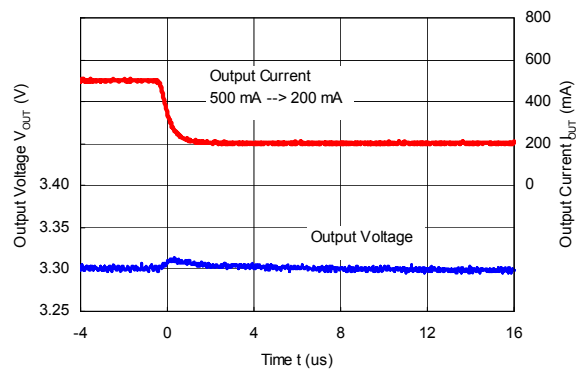
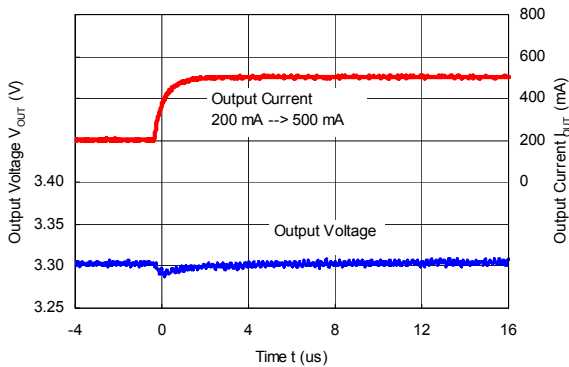

Load Transient Response ($C_{OUT} = 4.7\mu F, C1005X5R0J475M$)

RP508K081x ($V_{IN} = 3.6 V, V_{OUT} = 0.8 V$)
 L = MDT1608CHR47N (1608size_0.47 μH)
 MODE = "L" PWM/VFM auto switching control

RP508K081x ($V_{IN} = 3.6V, V_{OUT} = 0.8 V$)
 L = MDT1608CHR47N (1608size_0.47 μH)
 MODE = "L" PWM/VFM auto switching control



RP508K121x ($V_{IN} = 3.6 V, V_{OUT} = 1.2 V$)
 L = MDT1608CHR47N (1608size_0.47 μH)
 MODE = "L" PWM/VFM auto switching control

RP508K121x ($V_{IN} = 3.6 V, V_{OUT} = 1.2 V$)
 L = MDT1608CHR47N (1608size_0.47 μH)
 MODE = "L" PWM/VFM auto switching control



RP508K181x ($V_{IN} = 3.6 V, V_{OUT} = 1.8 V$)
 L = MDT1608CHR47N (1608size_0.47 μH)
 MODE = "L" PWM/VFM auto switching control

RP508K181x ($V_{IN} = 3.6 V, V_{OUT} = 1.8 V$)
 L = MDT1608CHR47N (1608size_0.47 μH)
 MODE = "L" PWM/VFM auto switching control



RP508K331x ($V_{IN} = 5.0\text{ V}$, $V_{OUT} = 3.3\text{ V}$)
 L = MDT1608CH1R0N (1608size_1.0 μH)
 MODE = "L" PWM/VFM auto switching control

RP508K331x ($V_{IN} = 5.0\text{ V}$, $V_{OUT} = 3.3\text{ V}$)
 L = MDT1608CH1R0N (1608size_1.0 μH)
 MODE = "L" PWM/VFM auto switching control

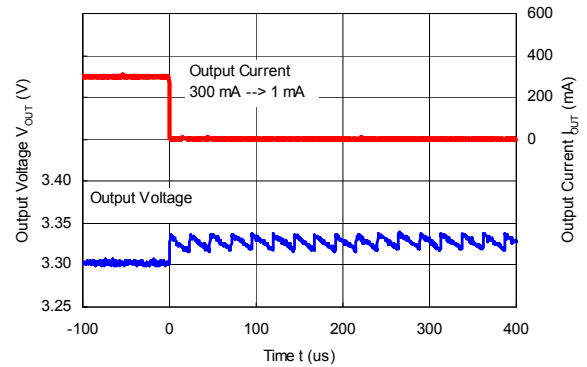
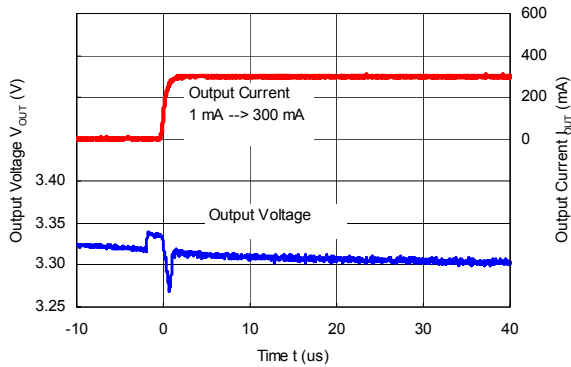

19) Mode Switching Waveform

RP508K121x ($V_{IN} = 3.6\text{ V}$, $V_{OUT} = 1.2\text{ V}$, $I_{OUT} = 1\text{ mA}$)
 MODE = "L" → MODE = "H"

RP508K121x ($V_{IN} = 3.6\text{ V}$, $V_{OUT} = 1.2\text{ V}$, $I_{OUT} = 1\text{ mA}$)
 MODE = "H" → MODE = "L"

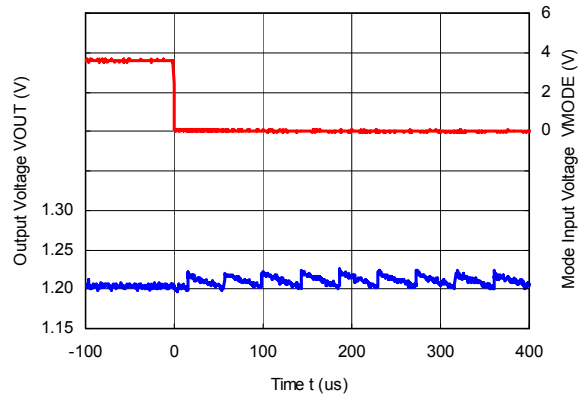
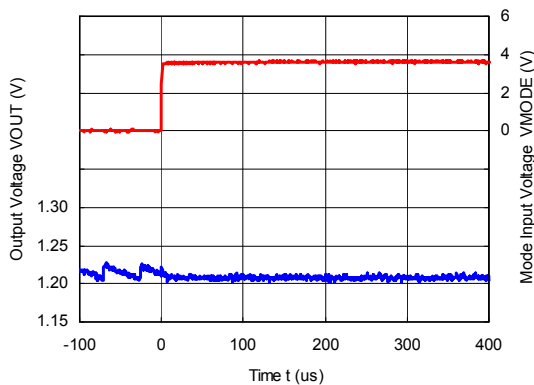

RP508K181x ($V_{IN} = 3.6\text{ V}$, $V_{OUT} = 1.8\text{ V}$, $I_{OUT} = 1\text{ mA}$)
 MODE = "L" → MODE = "H"

RP508K181x ($V_{IN} = 3.6\text{ V}$, $V_{OUT} = 1.8\text{ V}$, $I_{OUT} = 1\text{ mA}$)
 MODE = "H" → MODE = "L"

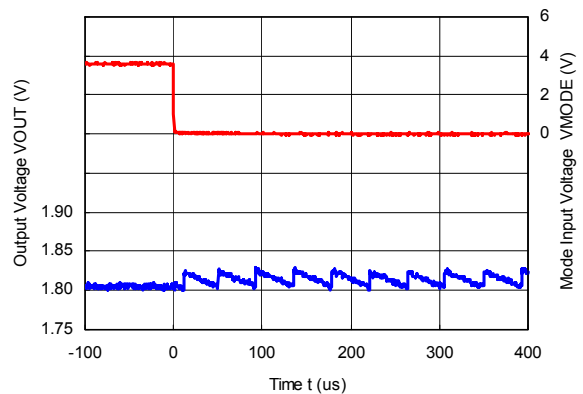
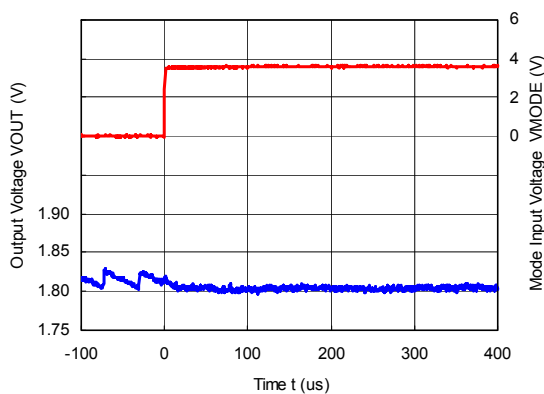



1. The products and the product specifications described in this document are subject to change or discontinuation of production without notice for reasons such as improvement. Therefore, before deciding to use the products, please refer to Ricoh sales representatives for the latest information thereon.
2. The materials in this document may not be copied or otherwise reproduced in whole or in part without prior written consent of Ricoh.
3. Please be sure to take any necessary formalities under relevant laws or regulations before exporting or otherwise taking out of your country the products or the technical information described herein.
4. The technical information described in this document shows typical characteristics of and example application circuits for the products. The release of such information is not to be construed as a warranty of or a grant of license under Ricoh's or any third party's intellectual property rights or any other rights.
5. The products listed in this document are intended and designed for use as general electronic components in standard applications (office equipment, telecommunication equipment, measuring instruments, consumer electronic products, amusement equipment etc.). Those customers intending to use a product in an application requiring extreme quality and reliability, for example, in a highly specific application where the failure or misoperation of the product could result in human injury or death (aircraft, spacevehicle, nuclear reactor control system, traffic control system, automotive and transportation equipment, combustion equipment, safety devices, life support system etc.) should first contact us.
6. We are making our continuous effort to improve the quality and reliability of our products, but semiconductor products are likely to fail with certain probability. In order to prevent any injury to persons or damages to property resulting from such failure, customers should be careful enough to incorporate safety measures in their design, such as redundancy feature, fire containment feature and fail-safe feature. We do not assume any liability or responsibility for any loss or damage arising from misuse or inappropriate use of the products.
7. Anti-radiation design is not implemented in the products described in this document.
8. Please contact Ricoh sales representatives should you have any questions or comments concerning the products or the technical information.



Ricoh is committed to reducing the environmental loading materials in electrical devices with a view to contributing to the protection of human health and the environment.

Ricoh has been providing RoHS compliant products since April 1, 2006 and Halogen-free products since April 1, 2012.

RICOH RICOH ELECTRONIC DEVICES CO., LTD.

<http://www.e-devices.ricoh.co.jp/en/>

Sales & Support Offices

RICOH ELECTRONIC DEVICES CO., LTD.

Higashi-Shinagawa Office (International Sales)
3-32-3, Higashi-Shinagawa, Shinagawa-ku, Tokyo 140-8655, Japan
Phone: +81-3-5479-2857 Fax: +81-3-5479-0502

RICOH EUROPE (NETHERLANDS) B.V.

Semiconductor Support Centre
Prof. W.H. Keesomlaan 1, 1183 DJ Amstelveen, The Netherlands
Phone: +31-20-5474-309

RICOH INTERNATIONAL B.V. - German Branch

Semiconductor Sales and Support Centre
Oberrather Strasse 6, 40472 Düsseldorf, Germany
Phone: +49-211-6546-0

RICOH ELECTRONIC DEVICES KOREA CO., LTD.

3F, Haesung Bldg, 504, Teheran-ro, Gangnam-gu, Seoul, 135-725, Korea
Phone: +82-2-2135-5700 Fax: +82-2-2051-5713

RICOH ELECTRONIC DEVICES SHANGHAI CO., LTD.

Room 403, No.2 Building, No.690 Bibo Road, Pu Dong New District, Shanghai 201203, People's Republic of China
Phone: +86-21-5027-3200 Fax: +86-21-5027-3299

RICOH ELECTRONIC DEVICES CO., LTD.

Taipei office
Room 109, 10F-1, No.51, Hengyang Rd., Taipei City, Taiwan (R.O.C.)
Phone: +886-2-2313-1621/1622 Fax: +886-2-2313-1623

Mouser Electronics

Authorized Distributor

Click to View Pricing, Inventory, Delivery & Lifecycle Information:

[Ricoch Electronics:](#)

[RP508K181A-TR](#) [RP508K101B-TR](#) [RP508K121A-TR](#) [RP508K181B-TR](#) [RP508K121B-TR](#) [RP508K331B-TR](#)

Компания «Океан Электроники» предлагает заключение долгосрочных отношений при поставках импортных электронных компонентов на взаимовыгодных условиях!

Наши преимущества:

- Поставка оригинальных импортных электронных компонентов напрямую с производств Америки, Европы и Азии, а так же с крупнейших складов мира;
- Широкая линейка поставок активных и пассивных импортных электронных компонентов (более 30 млн. наименований);
- Поставка сложных, дефицитных, либо снятых с производства позиций;
- Оперативные сроки поставки под заказ (от 5 рабочих дней);
- Экспресс доставка в любую точку России;
- Помощь Конструкторского Отдела и консультации квалифицированных инженеров;
- Техническая поддержка проекта, помощь в подборе аналогов, поставка прототипов;
- Поставка электронных компонентов под контролем ВП;
- Система менеджмента качества сертифицирована по Международному стандарту ISO 9001;
- При необходимости вся продукция военного и аэрокосмического назначения проходит испытания и сертификацию в лаборатории (по согласованию с заказчиком);
- Поставка специализированных компонентов военного и аэрокосмического уровня качества (Xilinx, Altera, Analog Devices, Intersil, Interpoint, Microsemi, Actel, Aeroflex, Peregrine, VPT, Syfer, Eurofarad, Texas Instruments, MS Kennedy, Miteq, Cobham, E2V, MA-COM, Hittite, Mini-Circuits, General Dynamics и др.);

Компания «Океан Электроники» является официальным дистрибьютором и эксклюзивным представителем в России одного из крупнейших производителей разъемов военного и аэрокосмического назначения «JONHON», а так же официальным дистрибьютором и эксклюзивным представителем в России производителя высокотехнологичных и надежных решений для передачи СВЧ сигналов «FORSTAR».



JONHON

«JONHON» (основан в 1970 г.)

Разъемы специального, военного и аэрокосмического назначения:

(Применяются в военной, авиационной, аэрокосмической, морской, железнодорожной, горно- и нефтедобывающей отраслях промышленности)

«FORSTAR» (основан в 1998 г.)

ВЧ соединители, коаксиальные кабели, кабельные сборки и микроволновые компоненты:

(Применяются в телекоммуникациях гражданского и специального назначения, в средствах связи, РЛС, а так же военной, авиационной и аэрокосмической отраслях промышленности).



Телефон: 8 (812) 309-75-97 (многоканальный)

Факс: 8 (812) 320-03-32

Электронная почта: ocean@oceanchips.ru

Web: <http://oceanchips.ru/>

Адрес: 198099, г. Санкт-Петербург, ул. Калинина, д. 2, корп. 4, лит. А