

### Product Description

The TriQuint TGA4852 is a medium power wideband AGC MMIC. Drain bias may be applied through the output port for best efficiency or through the on-chip drain termination. RF ports are DC coupled enabling the user to customize system corner frequencies. The TGA4852 requires off-chip decoupling and blocking components.

The TGA4852 is an excellent choice for 40Gb/s and 100Gb/s applications. The TGA4852 is capable of driving a modulator with an adjustable output voltage of 3-10 Vpp.

Bond pad and backside metallization is gold plated for compatibility with eutectic alloy attachment methods as well as the thermocompression and thermosonic wire bonding processes. Each device is 100% DC and RF tested on-wafer to ensure performance compliance. The device is available in die form.

Lead Free & RoHS Compliant.

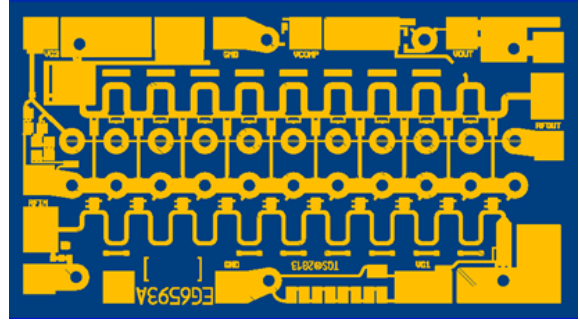

### Product Features

- 40 & 100Gb/s Optical Modulator Driver
- 0.15um Power pHEMT Technology
- On-chip Power Detector
- Bias:  $V_d = 6\text{ V}$ ,  $I_d = 215\text{ mA}$  (7 Vpp out)
- Chip Size: 1.80 x 1.00 x 0.1 mm

### Functional Block Diagram

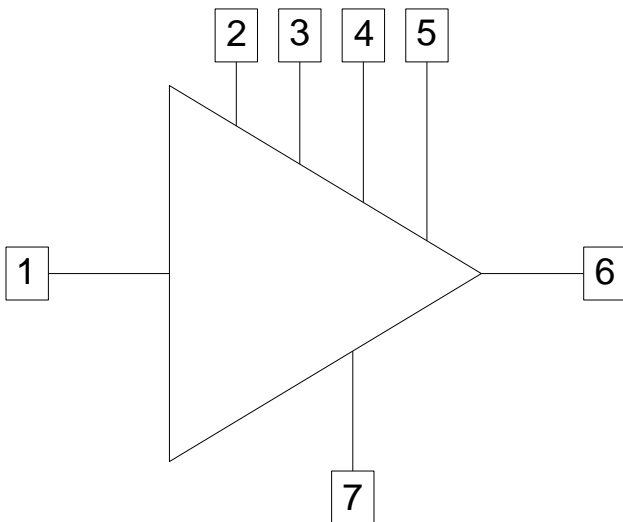

### Applications

- 40Gb/s DPSK / DQPSK Driver
- 100Gb/s DP-QPSK Driver
- 40Gb/s Predriver or Gain Block
- Test Equipment

### Ordering Information

Part No.	ECCN	Description
TGA4852	3A001.b.2.d	DC – 35GHz Amplifier

### Absolute Maximum Ratings

Parameter	Value / Range
Drain Voltage, Vd	9 V
Drain Voltage Termination, VdT	$(VdT - IdT \cdot 50) \leq 9$ V
Gate Voltage, Vg	-5 to 0 V
Control Voltage, Vc	MAX [(Vd-7), -1.3 V] to +3.9 V
Drain to Gate Voltage	13 V
Drain Current, Id	270 mA
Drain Current Termination, IdT	135 mA
Ig	-30 to + 16 mA
RF CW Input Power	10 Vpp (24 dBm)
Channel Temperature, Tch	200 °C
Mounting Temperature (30 sec)	320 °C
Storage Temperature	-40 to 150 °C

Notes:

1. Operation of this device outside the parameter ranges given above may cause permanent damage. These are stress ratings only, and functional operation of the device at these conditions is not implied.
2. If VdT pin is being used:  
assure  $(VdT - IdT \cdot 50) - Vc \geq -0.5$  V.
3. If RFout / Vd pin is being used:  
assure  $Vd - Vc \geq -0.5$  V.

### Recommended Operating Conditions

Parameter	Min	Typ	Max	Units
Vd		6		V
Id		215		mA
Vg		-1.8		V
Vc		0.7		V
Ig		<1		mA
Ic		<2		mA

Note:

1. Recommended operating conditions are measured at specified test conditions of  $V_{out} = 7$  Vpp when  $V_{in} = 3.6$  Vpp, 21.5 Gb/s.



## Electrical Specifications

Test conditions unless otherwise noted: 25 °C, Vd = 7 V, Vc = 0.8 V, Id = 190 mA, Vg ~ -1.8 V typical.

Parameter	Min	Typ	Max	Units
Operational Data rate		21.5		Gb/s
Small Signal Gain				
f = 0.1 - 20 GHz		11		dB
f = 20.1 - 30 GHz		10		
f = 30.1 - 35 GHz		9		
f = 35.1 - 40 GHz		6		
f = 40.1 - 50 GHz		4		
Input Return Loss				
f = 0.1 – 25 GHz		15		dB
f = 25.1 – 30 GHz		15		
f = 30.1 – 35 GHz		15		
f = 35.1 - 38 GHz		10		
f = 38.1 – 50 GHz		6		
Output Return Loss				
f = 0.1 - 20 GHz		15		dB
f = 20.1 - 30 GHz		12		
f = 30.1 - 35 GHz		10		
f = 35.1 - 50 GHz		-		
3 dB Bandwidth		37		GHz

### Thermal and Reliability Information

Parameter	Test Conditions	Value
Thermal Resistance, $\theta_{JC}$ , measured to back of package	Tbase = 70 °C	$\theta_{JC} = 43.1 \text{ } ^\circ\text{C/W}$
Channel Temperature (Tch), and Median Lifetime (Tm)	Tbase = 70 °C Vd = 6 V, Id = 200 mA Pdiss = 1.2 W	Tch = 122 °C Tm = 3E+7 Hours
Channel Temperature (Tch), and Median Lifetime (Tm) Under RF Drive	Tbase = 70 °C Vd = 6 V, Id = 215 mA Vout = 7 Vpp Pdiss = 1.17 W	Tch = 120 °C Tm = 3.7E+7 Hours

Notes

- Channel operating temperature will directly affect the device median lifetime (Tm). For maximum life, it is recommended that channel temperatures be maintained at the lowest possible levels.
- $\theta_{jc}$  is the thermal resistance of the die mounted to a 0.020" thick Cu-Mo block using 0.8 mil conductive epoxy.

### Median Lifetime

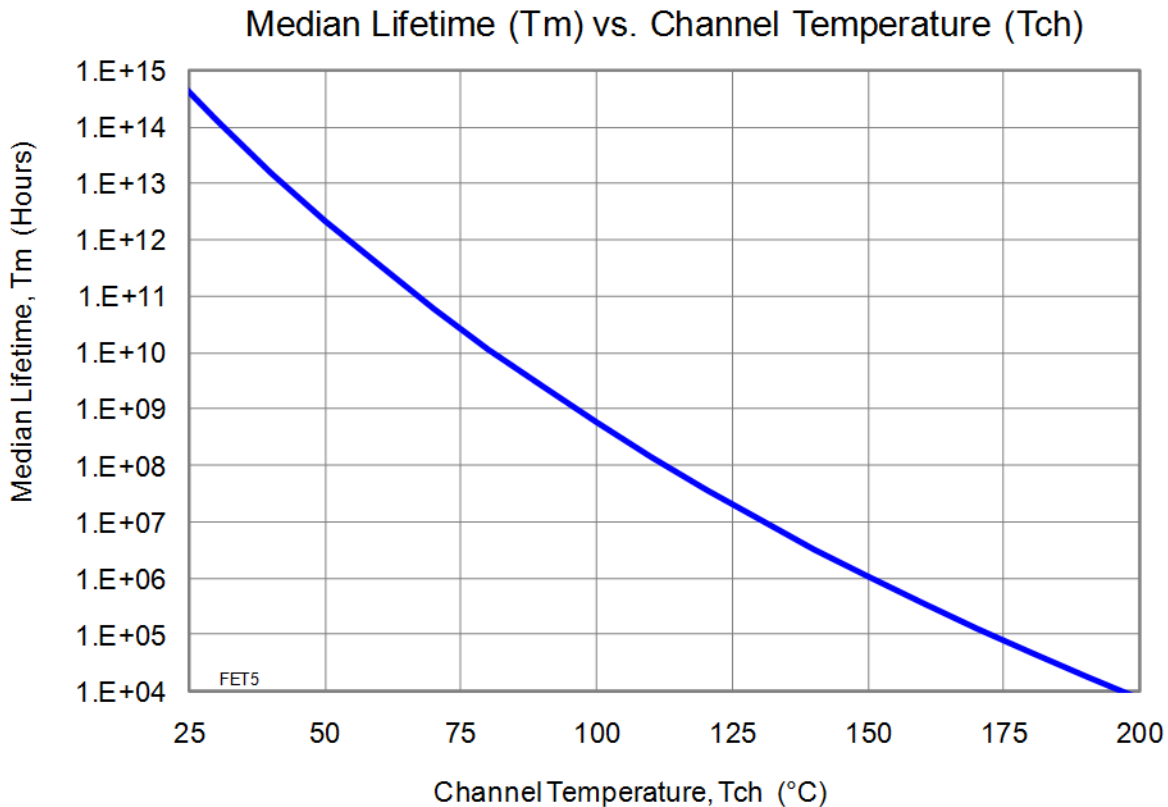

Typical Performance Electrical Eye Diagram

$V_{in} = 3.6 \text{ Vpp}$ ,  $21.5 \text{ Gb/s}$ , PRBS signal  $2^{31} - 1$ ,  $V_g$  adjusted to attain desired  $V_{out}$ ,  $T = 25 \text{ }^\circ\text{C}$

$V_d = 6 \text{ V}$ ,  $V_c = 0.7 \text{ V}$ ,  $I_d = 220 \text{ mA}$

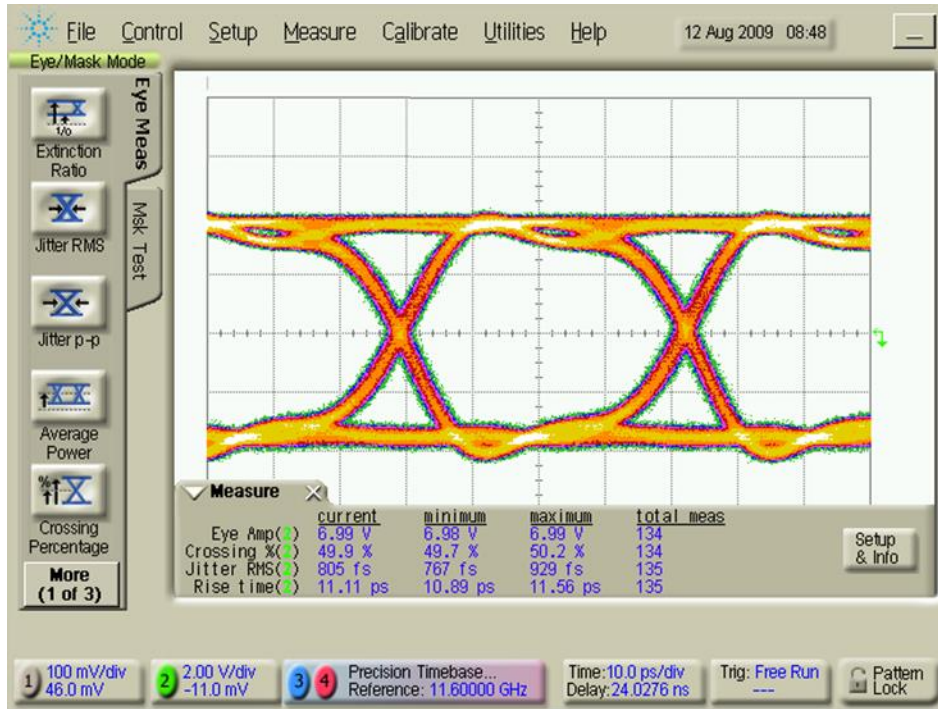

Vdet-Vref vs. Vout vs. Temperature

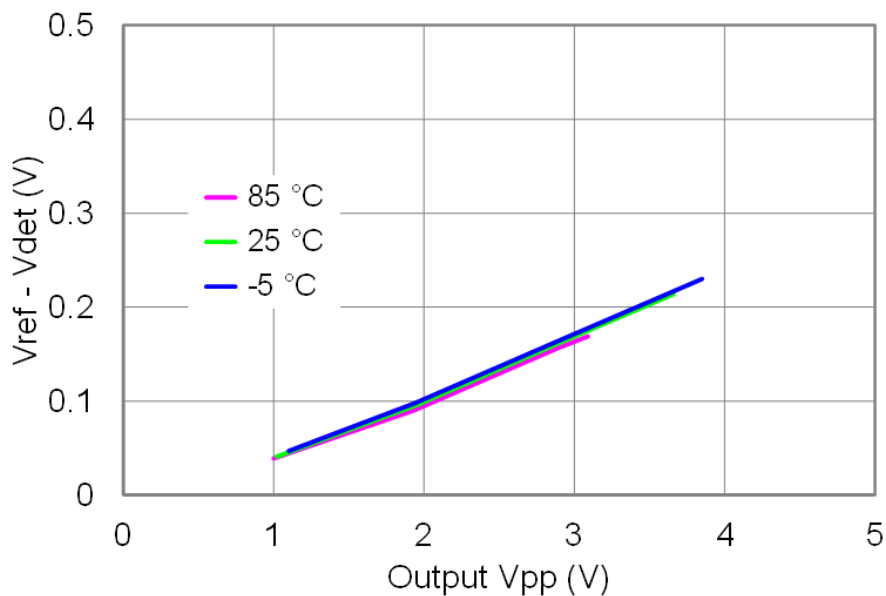

Typical Performance

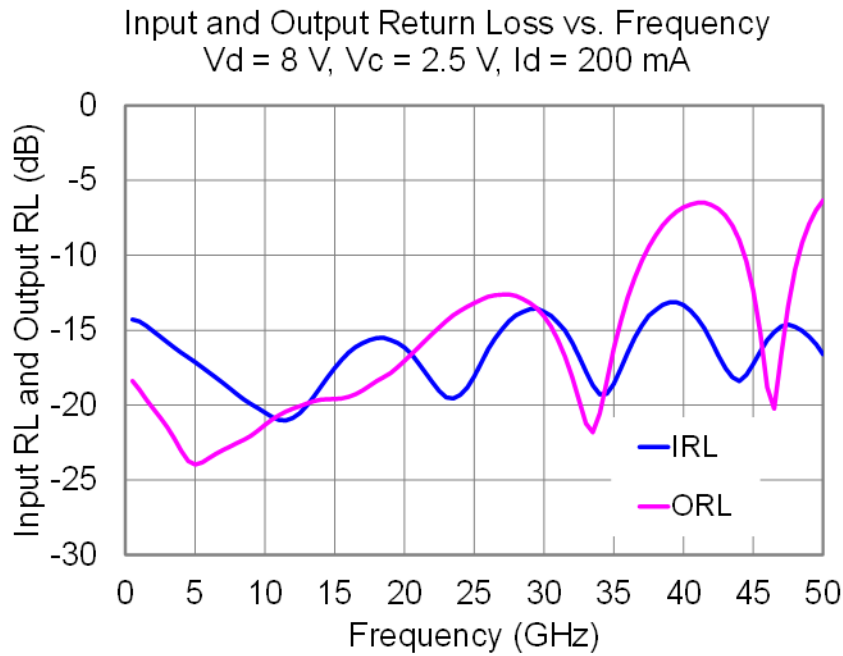
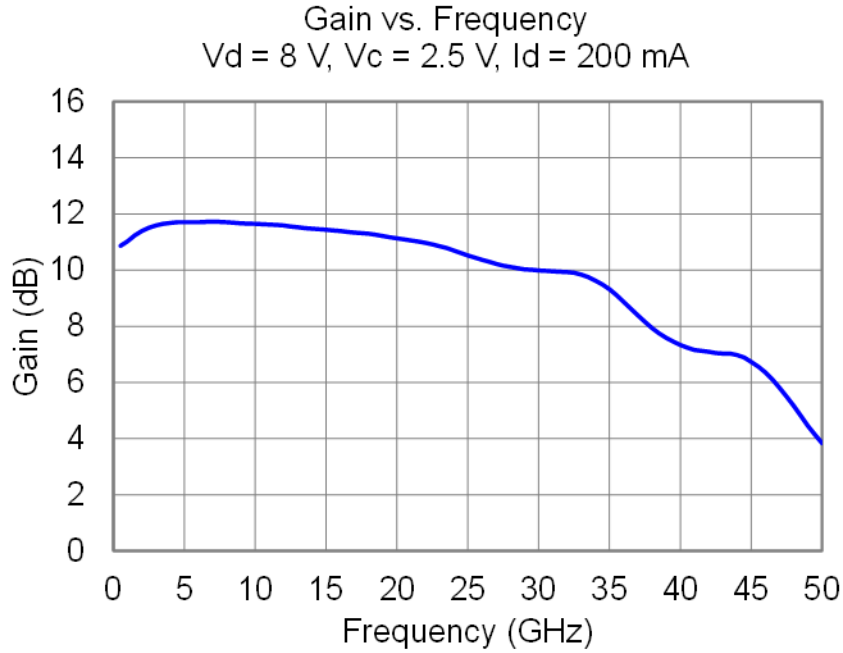

### Pin Configuration

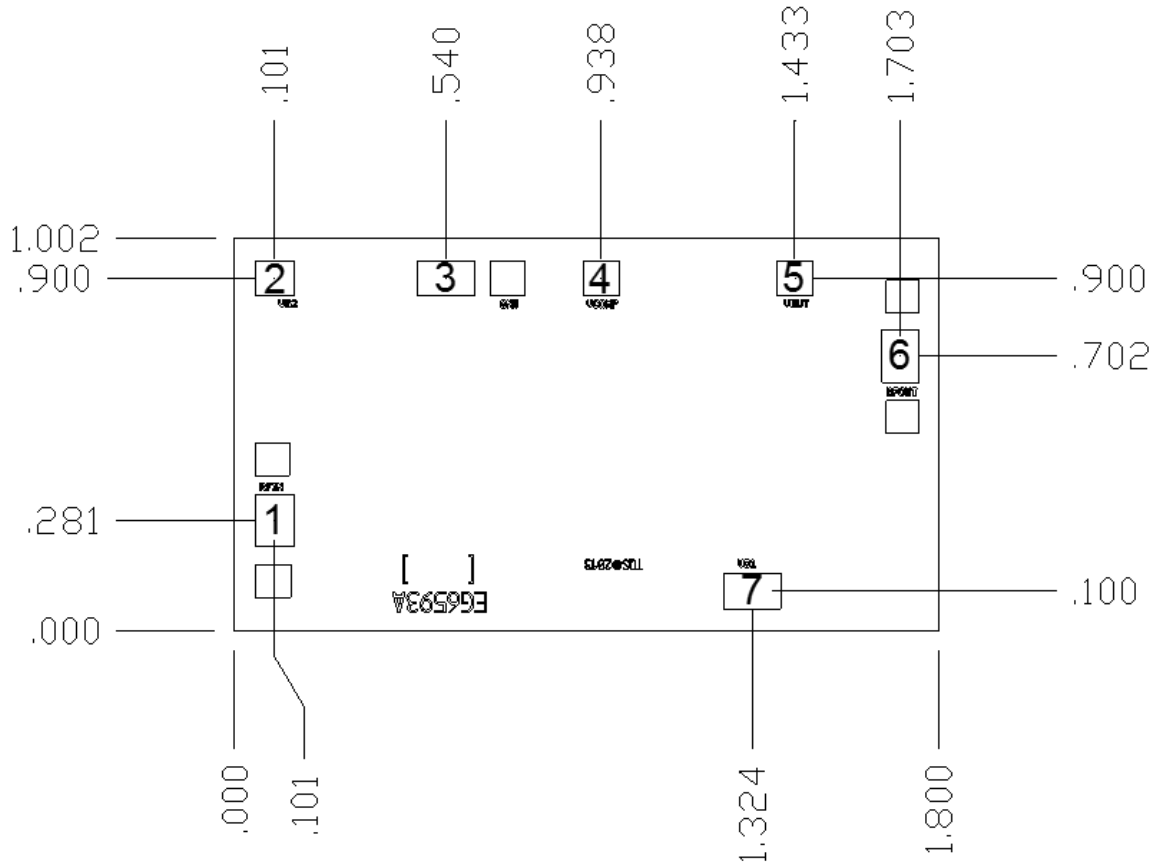

Units: millimeters  
 Chip edge to bond pad dimensions are shown to center of pad  
 Chip size tolerance:  $\pm 0.051$   
 Thickness: 0.100 (reference only)

### Pin Description

Pin No.	Label	Description	Pad Size
1	RFin	RF Input	0.099 x 0.133
2	Vc	Control voltage pin	0.090 x 0.090
3	VdT	Vd pin for biasing through the termination resistor	0.146 x 0.090
4	Vref	Diode reference voltage	0.090 x 0.090
5	Vdet	Diode detector output voltage	0.090 x 0.090
6	RFout / Vd (RFout)	RF Output and/or Vd bias pin (avoids voltage drop across termination resistor)	0.094 x 0.136
7	Vg	Gate voltage pin	0.146 x 0.090

## Application Circuit

### Recommended Chip Assembly Diagram

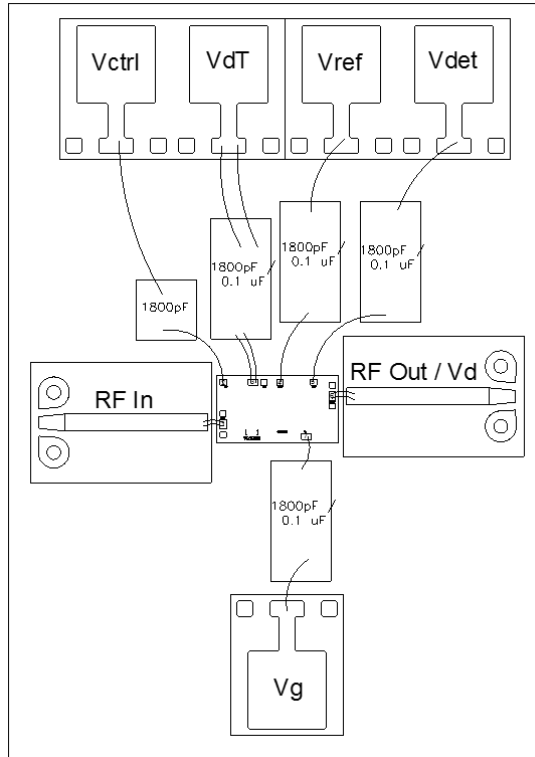

Note: Input and Output ports are DC coupled.  
If biasing Vd through the RFOut side, a bias tee is required.

## Evaluation Board Bias Procedures

Laboratory Bias-up Procedure: see Note 1	Laboratory Bias-down Procedure
Set Vg to -3 V	Turn off RF supply. See note 2
Set Vd or VdT to 6 V	Vg set to -3 V
Vc set to desired value	Vc set to 0 V
Adjust Vg more positive until target Id is reached.	Turn Vd to 0 V
Adjust Vc for desired Vout signal	Turn Vg to 0 V
Adjust Vg for 50% crossing	
Re-adjust Vc and Vg, if necessary	
Apply RF signal to RF Input. See note 2	

Notes:

- Any bias procedure will not harm the device as long as the guidelines explicitly stated in the Max Ratings Table and corresponding notes section on page 2 of the Datasheet are followed. For laboratory evaluation, the following is provided as a bias procedure that will allow user to observe and set each stage's quiescent point individually.
- RF supply can be on during power up and power down sequences.



## Assembly Notes

---

### Reflow Attachment:

- Use AuSn (80/20) solder with limited exposure to temperatures at or above 300°C
- Use alloy station or conveyor furnace with reducing atmosphere
- No fluxes should be utilized
- Coefficient of thermal expansion matching is critical for long-term reliability
- Storage in dry nitrogen atmosphere

### Adhesive Attachment:

- Organic attachment can be used in low-power applications
- Curing should be done in a convection oven; proper exhaust is a safety concern
- Microwave or radiant curing should not be used because of differential heating
- Coefficient of thermal expansion matching is critical

### Component Pickup and Placement:

- Vacuum pencil and/or vacuum collet preferred method of pick up
- Avoidance of air bridges during placement
- Force impact critical during auto placement

### Interconnect:

- Thermosonic ball bonding is the preferred interconnect technique
- Force, time, and ultrasonics are critical parameters
- Aluminum wire should not be used
- Discrete FET devices with small pad sizes should be bonded with 0.0007-inch wire
- Maximum stage temperature: 200°C

## Handling Precautions

Parameter	Rating	Standard	 Caution! ESD-Sensitive Device
ESD – Human Body Model (HBM)	TBD	JEDEC Standard JESD22 A114	

## Solderability

Compatible with AuSn eutectic solder

## RoHS Compliance

This product is compliant with the 2011/65/EU RoHS directive (Restrictions on the Use of Certain Hazardous Substances in Electrical and Electronic Equipment), as amended by Directive 2015/863/EU. This product also has the following attributes:

- Lead Free
- Halogen Free (Chlorine, Bromine)
- Antimony Free
- TBBP-A (C<sub>15</sub>H<sub>12</sub>Br<sub>4</sub>O<sub>2</sub>) Free
- PFOS Free
- SVHC Free



## Contact Information

For the latest specifications, additional product information, worldwide sales and distribution locations, and information about Qorvo:

Web: [www.qorvo.com](http://www.qorvo.com)      Tel: +1.972.994.8465  
 Email: [info-sales@qorvo.com](mailto:info-sales@qorvo.com)      Fax: +1.972.994.8504

For technical questions and application information:

Email: [info-products@qorvo.com](mailto:info-products@qorvo.com)

## Important Notice

The information contained herein is believed to be reliable; however, Qorvo makes no warranties regarding the information contained herein and assumes no responsibility or liability whatsoever for the use of the information contained herein. All information contained herein is subject to change without notice. Customers should obtain and verify the latest relevant information before placing orders for Qorvo products. The information contained herein or any use of such information does not grant, explicitly or implicitly, to any party any patent rights, licenses, or any other intellectual property rights, whether with regard to such information itself or anything described by such information. **THIS INFORMATION DOES NOT CONSTITUTE A WARRANTY WITH RESPECT TO THE PRODUCTS DESCRIBED HEREIN, AND QORVO HEREBY DISCLAIMS ANY AND ALL WARRANTIES WITH RESPECT TO SUCH PRODUCTS WHETHER EXPRESS OR IMPLIED BY LAW, COURSE OF DEALING, COURSE OF PERFORMANCE, USAGE OF TRADE OR OTHERWISE, INCLUDING THE IMPLIED WARRANTIES OF MERCHANTABILITY AND FITNESS FOR A PARTICULAR PURPOSE.**

Without limiting the generality of the foregoing, Qorvo products are not warranted or authorized for use as critical components in medical, life-saving, or life-sustaining applications, or other applications where a failure would reasonably be expected to cause severe personal injury or death.

Copyright 2016 © Qorvo, Inc. | Qorvo is a registered trademark of Qorvo, Inc.

Компания «Океан Электроники» предлагает заключение долгосрочных отношений при поставках импортных электронных компонентов на взаимовыгодных условиях!

Наши преимущества:

- Поставка оригинальных импортных электронных компонентов напрямую с производств Америки, Европы и Азии, а так же с крупнейших складов мира;
- Широкая линейка поставок активных и пассивных импортных электронных компонентов (более 30 млн. наименований);
- Поставка сложных, дефицитных, либо снятых с производства позиций;
- Оперативные сроки поставки под заказ (от 5 рабочих дней);
- Экспресс доставка в любую точку России;
- Помощь Конструкторского Отдела и консультации квалифицированных инженеров;
- Техническая поддержка проекта, помощь в подборе аналогов, поставка прототипов;
- Поставка электронных компонентов под контролем ВП;
- Система менеджмента качества сертифицирована по Международному стандарту ISO 9001;
- При необходимости вся продукция военного и аэрокосмического назначения проходит испытания и сертификацию в лаборатории (по согласованию с заказчиком);
- Поставка специализированных компонентов военного и аэрокосмического уровня качества (Xilinx, Altera, Analog Devices, Intersil, Interpoint, Microsemi, Actel, Aeroflex, Peregrine, VPT, Syfer, Eurofarad, Texas Instruments, MS Kennedy, Miteq, Cobham, E2V, MA-COM, Hittite, Mini-Circuits, General Dynamics и др.);

Компания «Океан Электроники» является официальным дистрибьютором и эксклюзивным представителем в России одного из крупнейших производителей разъемов военного и аэрокосмического назначения «JONHON», а так же официальным дистрибьютором и эксклюзивным представителем в России производителя высокотехнологичных и надежных решений для передачи СВЧ сигналов «FORSTAR».



## JONHON

«JONHON» (основан в 1970 г.)

Разъемы специального, военного и аэрокосмического назначения:

(Применяются в военной, авиационной, аэрокосмической, морской, железнодорожной, горно- и нефтедобывающей отраслях промышленности)

«FORSTAR» (основан в 1998 г.)

ВЧ соединители, коаксиальные кабели, кабельные сборки и микроволновые компоненты:

(Применяются в телекоммуникациях гражданского и специального назначения, в средствах связи, РЛС, а так же военной, авиационной и аэрокосмической отраслях промышленности).



Телефон: 8 (812) 309-75-97 (многоканальный)

Факс: 8 (812) 320-03-32

Электронная почта: [ocean@oceanchips.ru](mailto:ocean@oceanchips.ru)

Web: <http://oceanchips.ru/>

Адрес: 198099, г. Санкт-Петербург, ул. Калинина, д. 2, корп. 4, лит. А