



Aluminum electrolytic capacitors

Axial-lead and soldering star capacitors

Series/Type: B41695, B41795

Date: February 2011

Applications

- Compact design for automotive applications

Features

- Up to 150 °C operating temperature up to 55 V DC
- Rated voltage up to 100 V upon request
- High ripple current capability
- High vibration resistance
- Long useful life
- Compact design
- Optimized CV value
- Shelf life up to 15 years at storage temperatures up to 40 °C.
To ensure solderability, the capacitors should be built into the application within one year of delivery. After a total of two years' storage, the operating voltage must be applied for one hour to ensure the specified leakage current.

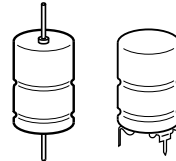

Construction

- Charge/discharge-proof, polar
- Aluminum case with insulating sleeve
- Negative pole connected to case

Terminals

- Axial leads, welded to ensure perfect electrical contact
- Also available with soldering stars

Taping and Packing

- Axial-lead capacitors will be delivered in pallet package.
Capacitors with $d \times l \leq 16 \times 30$ mm are also available taped on reel.
- Soldering star capacitors are packed in cardboard.

Specifications and characteristics in brief

Rated voltage V_R	25 ... 75 V DC						
Surge voltage V_S	$1.15 \cdot V_R$						
Rated capacitance C_R	220 ... 6800 μF						
Capacitance tolerance	$-10/+30\% \triangleq Q$						
Leakage current I_{leak} (5 min, 20 °C)	$I_{\text{leak}} \leq 0.006 \mu\text{A} \cdot \left(\frac{C_R}{\mu\text{F}} \cdot \frac{V_R}{V} \right) + 4 \mu\text{A}$						
Self-inductance ESL ¹⁾	Diameter d (mm)	12	14	16	18	20/21	
	Terminals	Length l (mm)	Approx. ESL (nH)				
	axial	25	–	22	–	–	–
		29	–	–	–	–	38
		30	21	24	29	34	–
		39	–	–	33	38	45
		49	–	–	–	–	50
	soldering star	25	–	6	–	–	–
		30	6	7	8	10	–
		39	–	–	9	11	13
49		–	–	–	–	14	
Useful life 150 °C; V_{op} ; $0.5 \cdot I_{\text{AC,R}}^{\text{*)}$ 140 °C; V_R ; $I_{\text{AC,R}}$ 125 °C; V_R ; $I_{\text{AC,R}}$ 85 °C; V_R ; $I_{\text{AC,max}}$ 40 °C; V_R ; $2.1 \cdot I_{\text{AC,R}}$ ^{*)} V_{op} : see useful life graph	> 1000 h	Requirements: $\Delta C/C \leq \pm 30\%$ of initial value ESR ≤ 3 times initial specified limit $I_{\text{leak}} \leq$ initial specified limit					
	> 1000 h						
	> 3000 h						
	> 8000 h						
	> 200000 h						
Voltage endurance test 125 °C; V_R	2000 h	Post test requirements: $\Delta C/C \leq \pm 10\%$ of initial value ESR $\leq 1.3\%$ initial specified limit $I_{\text{leak}} \leq$ initial specified limit					
		Vibration resistance test To IEC 60068-2-6, test Fc: Frequency range 10 Hz ... 2 kHz, displacement amplitude max. 1.5 mm, acceleration max. 20 g, duration 3×2 h. Capacitor mounted by its wire leads at a distance of (6 ± 1) mm from the case and additionally clamped by the case.					
		IEC climatic category To IEC 60068-1: 55/125/56 (-55 °C/ $+125$ °C/56 days damp heat test)					
Detail specification	Similar to CECC 30301-802						
Sectional specification	IEC 60384-4						

1) If optimum circuit design is used, the values are lower by 30%.



B41695, B41795

Compact – up to 150 °C

B41695, Axial-lead capacitors

Dimensional drawing

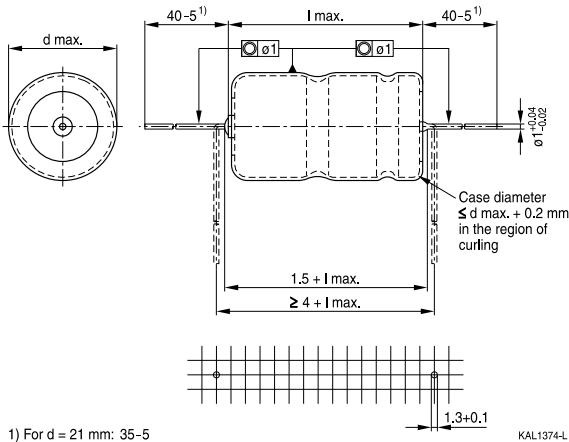

Dimensions, weights and packing units

$d \times l$ mm	$d_{max} \times l_{max}$ mm	Approx. weight g	Packing units (pcs.)	
			Pallet	Reel
12 × 30	12.5 × 30.5	5.1	288	450
14 × 25	14.5 × 25.5	5.7	200	350
14 × 30	14.5 × 30.5	6.8	200	350
16 × 30	16.5 × 30.5	8.9	180	250
16 × 39	16.5 × 40	11.7	180	—
18 × 30	18.5 × 30.5	11.1	160	—
18 × 39	18.5 × 40	14.7	160	—
20 × 29	20.5 × 29.5	13.5	140	—
21 × 39	21.5 × 40	20.0	140	—
21 × 49	21.5 × 50	25.0	110	—

B41795, Soldering star capacitors
Dimensional drawings

 Mounting holes $d = 12 \text{ mm} \dots 14 \text{ mm}$

 Mounting holes $d = 16 \text{ mm} \dots 21 \text{ mm}$

Dimensions, weights and packing units

$d \times l$ mm	$d_{\max} \times l_{\max}$ mm	$c \pm 0.1$ mm	$e \pm 0.1$ mm	Approx. weight g	Packing units pcs.
12 × 30	13.5 × 32	12.5	3.0	5.4	480
14 × 25	15.5 × 27	14.5	3.0	6.1	480
14 × 30	15.5 × 32	14.5	3.0	7.2	480
16 × 30	17.5 × 32	16.5	3.0	9.4	300
16 × 39	17.5 × 41.5	16.5	3.0	12.2	200
18 × 30	19.5 × 32	18.5	3.0	11.8	300
18 × 39	19.5 × 41.5	18.5	3.0	15.4	200
21 × 39	22.5 × 41.5	21.5	3.5	21.0	324
21 × 49	22.5 × 51.5	21.5	3.5	26.0	264



B41695, B41795

Compact – up to 150 °C

Overview of available types

V_R (V DC)	25	40	63	75
	Case dimensions d × l (mm)			
C_R (μF)				
220			12 × 30	12 × 30
270				14 × 30
330			14 × 30	
390				16 × 30
470		12 × 30	16 × 30	
560				16 × 39
680	12 × 30	14 × 30	16 × 39	
860				18 × 39 20 × 29
1000	14 × 25	16 × 30	18 × 39	
1100			20 × 29	
1200				21 × 39
1500	16 × 30	16 × 39		
1800			21 × 39	21 × 49
2200	18 × 30	18 × 39 20 × 29	21 × 49	
3300	18 × 39 20 × 29	21 × 39		
4400		21 × 49		
5000	21 × 39			
6800	21 × 49			

Case dimensions and ordering codes

V_R	C_R	Case dimensions $d \times l$ mm	Ordering code Axial pallet	Ordering code Axial reel	Ordering code Soldering star
25	100 Hz	12 × 30	B41695A5687Q007	B41695A5687Q009	B41795A5687Q000
	20 °C	14 × 25	B41695A5108Q007	B41695A5108Q009	B41795A5108Q000
	μF	16 × 30	B41695A5158Q007	B41695A5158Q009	B41795A5158Q000
		18 × 30	B41695A5228Q007		B41795A5228Q000
		18 × 39	B41695A5338Q007		B41795A5338Q000
		20 × 29	B41695B5338Q007		
		21 × 39	B41695A5508Q007		B41795A5508Q000
		21 × 49	B41695A5688Q007		B41795A5688Q000
40		12 × 30	B41695A7477Q007	B41695A7477Q009	B41795A7477Q000
		14 × 30	B41695A7687Q007	B41695A7687Q009	B41795A7687Q000
		16 × 30	B41695A7108Q007	B41695A7108Q009	B41795A7108Q000
		16 × 39	B41695A7158Q007		B41795A7158Q000
		18 × 39	B41695A7228Q007		B41795A7228Q000
		20 × 29	B41695B7228Q007		
		21 × 39	B41695A7338Q007		B41795A7338Q000
		21 × 49	B41695A7448Q007		B41795A7448Q000
63		12 × 30	B41695A8227Q007	B41695A8227Q009	B41795A8227Q000
		14 × 30	B41695A8337Q007	B41695A8337Q009	B41795A8337Q000
		16 × 30	B41695A8477Q007	B41695A8477Q009	B41795A8477Q000
		16 × 39	B41695A8687Q007		B41795A8687Q000
		18 × 39	B41695A8108Q007		B41795A8108Q000
		20 × 29	B41695A8118Q007		
		21 × 39	B41695A8188Q007		B41795A8188Q000
		21 × 49	B41695A8228Q007		B41795A8228Q000
75		12 × 30	B41695A0227Q007	B41695A0227Q009	B41795A0227Q000
		14 × 30	B41695A0277Q007	B41695A0277Q009	B41795A0277Q000
		16 × 30	B41695A0397Q007	B41695A0397Q009	B41795A0397Q000
		16 × 39	B41695A0567Q007		B41795A0567Q000
		18 × 39	B41695A0867Q007		B41795A0867Q000
		20 × 29	B41695B0867Q007		
		21 × 39	B41695A0128Q007		B41795A0128Q000
		21 × 49	B41695A0188Q007		B41795A0188Q000

∇ Variant with different case dimensions

B41695, B41795
Compact – up to 150 °C
Technical data

C_R	ESR_{typ}	ESR_{max}	ESR_{max}	ESR_{max}	Z_{max}	$I_{AC,max}$	$I_{AC,max}$	$I_{AC,max}$	$I_{AC,R}$	$I_{AC,max}^{1)}$
100 Hz	100 Hz	100 Hz	100 Hz	10 kHz	100 kHz	10 kHz	10 kHz	10 kHz	10 kHz	10 kHz
20 °C	20 °C	20 °C	-40 °C	20 °C	20 °C	85 °C	105 °C	125 °C	125 °C	150 °C
μF	$m\Omega$	$m\Omega$	$m\Omega$	$m\Omega$	$m\Omega$	A	A	A	A	A
$V_R = 25 V DC$										
680	190	320	2800	240	220	3.2	2.75	2.1	1.4	0.7
1000	135	230	1900	170	160	3.6	3.1	2.35	1.55	0.75
1500	90	155	1200	115	105	4.7	4.0	3.0	2.05	1.0
2200	65	110	950	85	80	5.8	5.0	3.8	2.5	1.2
3300	45	75	700	58	55	8.1	7.0	5.3	3.5	1.7
3300 ∇	40	70	700	53	50	8.1	7.0	5.3	3.5	1.7
5000	28	48	500	36	35	11.5	10	7.5	5.0	2.5
6800	22	36	350	28	28	14.5	12.6	9.5	6.3	3.1
$V_R = 40 V DC$										
470	175	290	3000	185	180	3.5	3.0	2.3	1.5	0.75
680	125	205	2200	135	130	4.4	3.8	2.85	1.9	0.85
1000	90	145	1500	95	91	5.3	4.6	3.45	2.3	1.15
1500	60	100	1000	65	62	7.3	6.4	4.8	3.2	1.6
2200	45	75	700	50	48	8.3	7.2	5.4	3.6	1.8
2200 ∇	41	68	700	45	44	8.5	7.3	5.5	3.7	1.8
3300	28	45	500	30	30	12.0	10.4	7.8	5.2	2.6
4400	22	35	350	23	25	15.2	13.3	9.9	6.6	3.3
$V_R = 63 V DC$										
220	250	410	3000	200	190	3.4	2.95	2.2	1.5	0.75
330	170	275	2200	140	133	4.3	3.75	2.8	1.9	0.95
470	120	200	1500	100	105	5.1	4.5	3.3	2.25	1.1
680	85	140	1100	70	67	7.1	6.2	4.6	3.1	1.5
1000	62	100	750	55	54	8.2	7.1	5.4	3.6	1.8
1100	53	87	700	45	45	8.4	7.3	5.5	3.7	1.8
1800	34	55	500	30	30	12.2	10.6	7.9	5.3	2.6
2200	27	45	360	24	24	15.2	13.2	9.9	6.6	3.3
$V_R = 75 V DC$										
220	250	410	3000	200	190	3.4	2.95	2.2	1.5	0.75
270	170	275	2200	140	133	4.3	3.75	2.8	1.9	0.95
390	120	200	1500	100	105	5.1	4.5	3.3	2.25	1.1
560	85	140	1100	70	67	7.1	6.2	4.6	3.1	1.5
860	53	87	700	45	45	8.4	7.3	5.5	3.7	1.8
860	62	100	750	55	54	8.2	7.1	5.4	3.6	1.8
1200	34	55	500	30	30	12.2	10.6	7.9	5.3	2.6
1800	27	45	360	24	24	15.2	13.2	9.9	6.6	3.3

 ∇ Variant with different case dimensions

 1) $I_{AC,max}$ (10 kHz, 150 °C) measured at $V_R = 20 V DC, 35 V DC, 55 V DC, 65 V DC$ instead of $V_R = 25 V DC, 40 V DC, 63 V DC, 75 V DC$.



Useful life

depending on ambient temperature T_A under ripple current operating conditions at $V_R^{1)}$

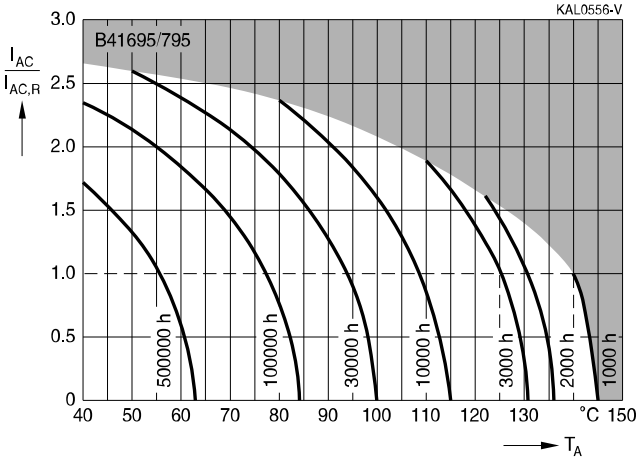

Useful life

depending on case temperature T_C under ripple current operating conditions at $V_R^{1)}$

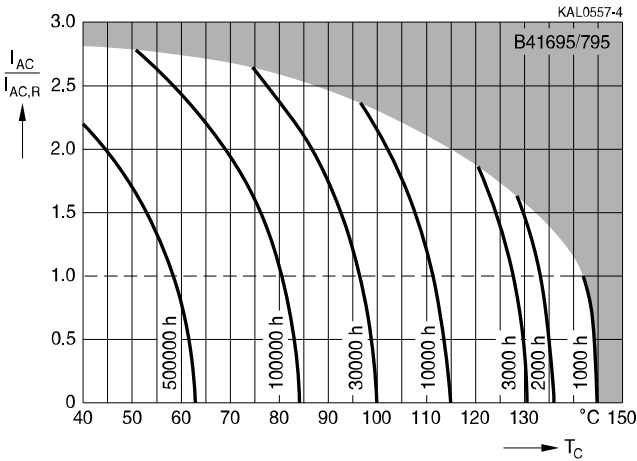

1) Refer to chapter "General technical information, 5.3 Calculation of useful life" for an explanation on how to interpret the useful life graphs.

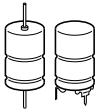

B41695, B41795

Compact – up to 150 °C

Useful life

depending on ambient temperature T_A under ripple current operating conditions at $V_{op}^{2)}$

$V_R = 25 \text{ V}$: $V_{op} \leq 20 \text{ V}$

$V_R = 40 \text{ V}$: $V_{op} \leq 35 \text{ V}$

$V_R = 63 \text{ V}$: $V_{op} \leq 55 \text{ V}$

$V_R = 75 \text{ V}$: $V_{op} \leq 65 \text{ V}$

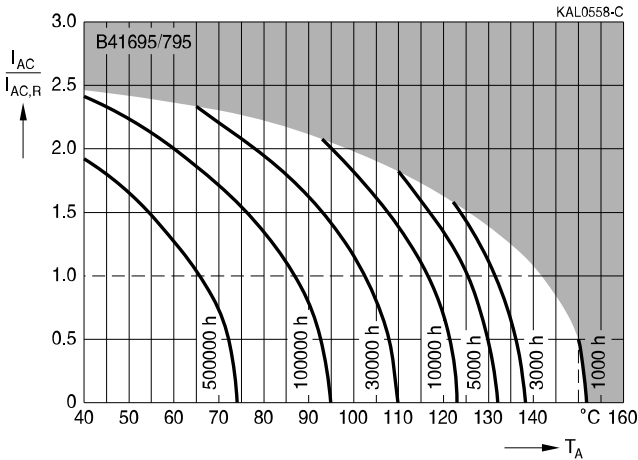

Useful life

depending on case temperature T_C under ripple current operating conditions at $V_{op}^{2)}$

$V_R = 25 \text{ V}$: $V_{op} \leq 20 \text{ V}$

$V_R = 40 \text{ V}$: $V_{op} \leq 35 \text{ V}$

$V_R = 63 \text{ V}$: $V_{op} \leq 55 \text{ V}$

$V_R = 75 \text{ V}$: $V_{op} \leq 65 \text{ V}$

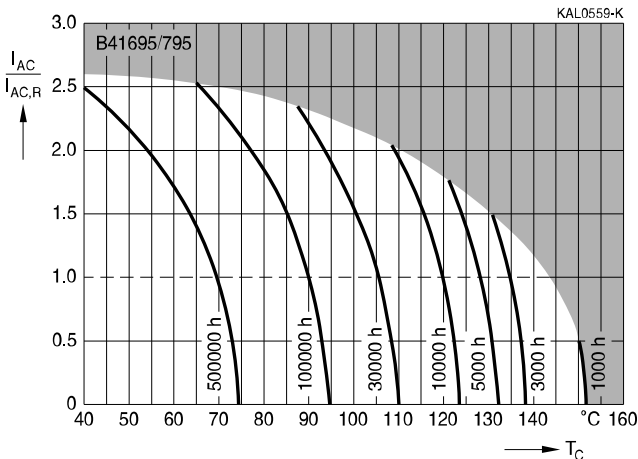

2) Refer to chapter "General technical information, 5.3 Calculation of useful life" for an explanation on how to interpret the useful life graphs.



Frequency factor of permissible ripple current I_{AC} versus frequency f



Frequency characteristics of ESR
Typical behavior

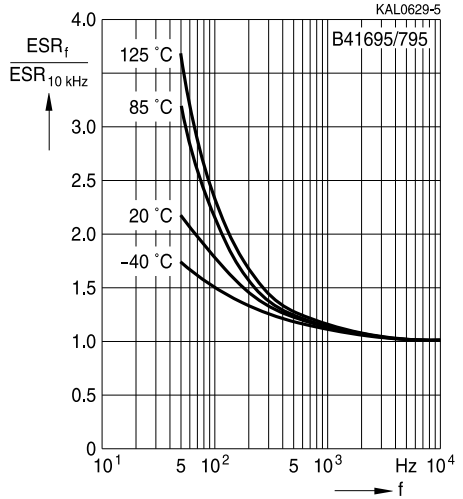

Equivalent series resistance ESR versus frequency f

Typical behavior for 2200 μ F/40 V

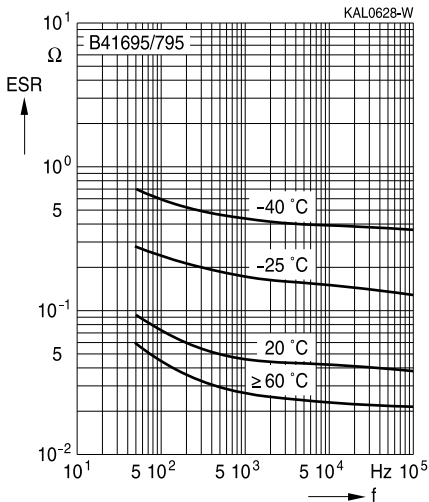

Impedance Z versus frequency f

Typical behavior for 2200 μ F/40 V

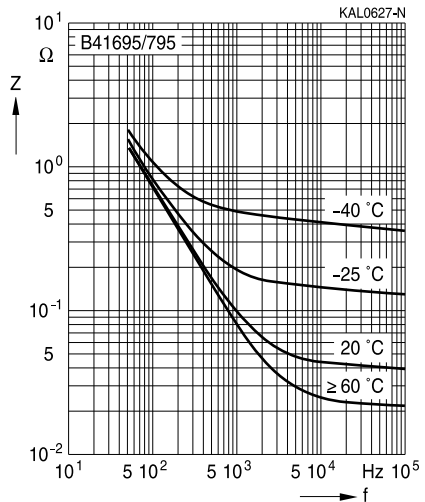

**B41695, B41795****Compact – up to 150 °C**

Cautions and warnings

Personal safety

The electrolytes used by EPCOS have not only been optimized with a view to the intended application, but also with regard to health and environmental compatibility. They do not contain any solvents that are detrimental to health, e.g. dimethyl formamide (DMF) or dimethyl acetamide (DMAC).

Furthermore, part of the high-voltage electrolytes used by EPCOS are self-extinguishing. They contain flame-retarding substances which will quickly extinguish any flame that may have been ignited.

As far as possible, EPCOS does not use any dangerous chemicals or compounds to produce operating electrolytes. However, in exceptional cases, such materials must be used in order to achieve specific physical and electrical properties because no safe substitute materials are currently known. However, the amount of dangerous materials used in our products has been limited to an absolute minimum. Nevertheless, the following rules should be observed when handling aluminum electrolytic capacitors:

- Any escaping electrolyte should not come into contact with eyes or skin.
- If electrolyte does come into contact with the skin, wash the affected parts immediately with running water. If the eyes are affected, rinse them for 10 minutes with plenty of water. If symptoms persist, seek medical treatment.
- Avoid breathing in electrolyte vapor or mists. Workplaces and other affected areas should be well ventilated. Clothing that has been contaminated by electrolyte must be changed and rinsed in water.



Product safety

The table below summarizes the safety instructions that must be observed without fail. A detailed description can be found in the relevant sections of chapter "General technical information".

Topic	Safety information	Reference chapter "General technical information"
Polarity	Make sure that polar capacitors are connected with the right polarity.	1 "Basic construction of aluminum electrolytic capacitors"
Reverse voltage	Voltages polarity classes should be prevented by connecting a diode.	3.1.6 "Reverse voltage"
Upper category temperature	Do not exceed the upper category temperature.	7.2 "Maximum permissible operating temperature"
Maintenance	Make periodic inspections of the capacitors. Before the inspection, make sure that the power supply is turned off and carefully discharge the electricity of the capacitors. Do not apply any mechanical stress to the capacitor terminals.	10 "Maintenance"
Mounting position of screw-terminal capacitors	Do not mount the capacitor with the terminals (safety vent) upside down.	11.1. "Mounting positions of capacitors with screw terminals"
Mounting of single-ended capacitors	The internal structure of single-ended capacitors might be damaged if excessive force is applied to the lead wires. Avoid any compressive, tensile or flexural stress. Do not move the capacitor after soldering to PC board. Do not pick up the PC board by the soldered capacitor. Do not insert the capacitor on the PC board with a hole space different to the lead space specified.	11.4 "Mounting considerations for single-ended capacitors"
Robustness of terminals	The following maximum tightening torques must not be exceeded when connecting screw terminals: M5: 2 Nm M6: 2.5 Nm	11.3 "Mounting torques"
Soldering	Do not exceed the specified time or temperature limits during soldering.	11.5 "Soldering"



B41695, B41795

Compact – up to 150 °C

Topic	Safety information	Reference chapter "General technical information"
Soldering, cleaning agents	Do not allow halogenated hydrocarbons to come into contact with aluminum electrolytic capacitors.	11.6 "Cleaning agents"
Passive flammability	Avoid external energy, such as fire or electricity.	8.1 "Passive flammability"
Active flammability	Avoid overload of the capacitors.	8.2 "Active flammability"
		Reference chapter "Capacitors with screw terminals"
Breakdown strength of insulating sleeves	Do not damage the insulating sleeve, especially when ring clips are used for mounting.	"Screw terminals – accessories"

Symbols and terms

Symbol	English	German
C	Capacitance	Kapazität
C_R	Rated capacitance	Nennkapazität
C_S	Series capacitance	Serienkapazität
$C_{S,T}$	Series capacitance at temperature T	Serienkapazität bei Temperatur T
C_f	Capacitance at frequency f	Kapazität bei Frequenz f
d	Case diameter, nominal dimension	Gehäusedurchmesser, Nennmaß
d_{max}	Maximum case diameter	Maximaler Gehäusedurchmesser
ESL	Self-inductance	Eigeninduktivität
ESR	Equivalent series resistance	Ersatzserienwiderstand
ESR_f	Equivalent series resistance at frequency f	Ersatzserienwiderstand bei Frequenz f
ESR_T	Equivalent series resistance at temperature T	Ersatzserienwiderstand bei Temperatur T
f	Frequency	Frequenz
I	Current	Strom
I_{AC}	Alternating current (ripple current)	Wechselstrom
$I_{AC,rms}$	Root-mean-square value of alternating current	Wechselstrom, Effektivwert
$I_{AC,f}$	Ripple current at frequency f	Wechselstrom bei Frequenz f
$I_{AC,max}$	Maximum permissible ripple current	Maximal zulässiger Wechselstrom
$I_{AC,R}$	Rated ripple current	Nennwechselstrom
$I_{AC,R} (B)$	Rated ripple current for base cooling	Nennwechselstromstrom für Bodenkühlung
I_{leak}	Leakage current	Reststrom
$I_{leak,op}$	Operating leakage current	Betriebsreststrom
l	Case length, nominal dimension	Gehäuselänge, Nennmaß
l_{max}	Maximum case length (without terminals and mounting stud)	Maximale Gehäuselänge (ohne Anschlüsse und Gewindebolzen)
R	Resistance	Widerstand
R_{ins}	Insulation resistance	Isolationswiderstand
R_{symm}	Balancing resistance	Symmetrierwiderstand
T	Temperature	Temperatur
ΔT	Temperature difference	Temperaturdifferenz
T_A	Ambient temperature	Umgebungstemperatur
T_C	Case temperature	Gehäusetemperatur
T_B	Capacitor base temperature	Temperatur des Becherbodens
t	Time	Zeit
Δt	Period	Zeitraum
t_b	Service life (operating hours)	Brauchbarkeitsdauer (Betriebszeit)

B41695, B41795
Compact – up to 150 °C

Symbol	English	German
V	Voltage	Spannung
V _F	Forming voltage	Formierspannung
V _{op}	Operating voltage	Betriebsspannung
V _R	Rated voltage, DC voltage	Nennspannung, Gleichspannung
V _S	Surge voltage	Spitzenspannung
X _C	Capacitive reactance	Kapazitiver Blindwiderstand
X _L	Inductive reactance	Induktiver Blindwiderstand
Z	Impedance	Scheinwiderstand
Z _T	Impedance at temperature T	Scheinwiderstand bei Temperatur T
tan δ	Dissipation factor	Verlustfaktor
λ	Failure rate	Ausfallrate
ε ₀	Absolute permittivity	Elektrische Feldkonstante
ε _r	Relative permittivity	Dielektrizitätszahl
ω	Angular velocity; 2 · π · f	Kreisfrequenz; 2 · π · f

Note

All dimensions are given in mm.

Important notes

The following applies to all products named in this publication:

1. Some parts of this publication contain **statements about the suitability of our products for certain areas of application**. These statements are based on our knowledge of typical requirements that are often placed on our products in the areas of application concerned. We nevertheless expressly point out **that such statements cannot be regarded as binding statements about the suitability of our products for a particular customer application**. As a rule, EPCOS is either unfamiliar with individual customer applications or less familiar with them than the customers themselves. For these reasons, it is always ultimately incumbent on the customer to check and decide whether an EPCOS product with the properties described in the product specification is suitable for use in a particular customer application.
2. We also point out that **in individual cases, a malfunction of electronic components or failure before the end of their usual service life cannot be completely ruled out in the current state of the art, even if they are operated as specified**. In customer applications requiring a very high level of operational safety and especially in customer applications in which the malfunction or failure of an electronic component could endanger human life or health (e.g. in accident prevention or lifesaving systems), it must therefore be ensured by means of suitable design of the customer application or other action taken by the customer (e.g. installation of protective circuitry or redundancy) that no injury or damage is sustained by third parties in the event of malfunction or failure of an electronic component.
3. **The warnings, cautions and product-specific notes must be observed.**
4. In order to satisfy certain technical requirements, **some of the products described in this publication may contain substances subject to restrictions in certain jurisdictions (e.g. because they are classed as hazardous)**. Useful information on this will be found in our Material Data Sheets on the Internet (www.epcos.com/material). Should you have any more detailed questions, please contact our sales offices.
5. We constantly strive to improve our products. Consequently, **the products described in this publication may change from time to time**. The same is true of the corresponding product specifications. Please check therefore to what extent product descriptions and specifications contained in this publication are still applicable before or when you place an order. We also **reserve the right to discontinue production and delivery of products**. Consequently, we cannot guarantee that all products named in this publication will always be available. The aforementioned does not apply in the case of individual agreements deviating from the foregoing for customer-specific products.
6. Unless otherwise agreed in individual contracts, **all orders are subject to the current version of the "General Terms of Delivery for Products and Services in the Electrical Industry" published by the German Electrical and Electronics Industry Association (ZVEI)**.
7. The trade names EPCOS, BAOKE, Alu-X, CeraDiode, CSMP, CSSP, CTVS, DeltaCap, DigiSiMic, DSSP, FormFit, MiniBlue, MiniCell, MKK, MKD, MLSC, MotorCap, PCC, PhaseCap, PhaseCube, PhaseMod, PhiCap, SIFERRIT, SIFI, SIKOREL, SilverCap, SIMDAD, SiMic, SIMID, SineFormer, SIOV, SIP5D, SIP5K, ThermoFuse, WindCap are **trade-marks registered or pending** in Europe and in other countries. Further information will be found on the Internet at www.epcos.com/trademarks.

Компания «Океан Электроники» предлагает заключение долгосрочных отношений при поставках импортных электронных компонентов на взаимовыгодных условиях!

Наши преимущества:

- Поставка оригинальных импортных электронных компонентов напрямую с производств Америки, Европы и Азии, а так же с крупнейших складов мира;
- Широкая линейка поставок активных и пассивных импортных электронных компонентов (более 30 млн. наименований);
- Поставка сложных, дефицитных, либо снятых с производства позиций;
- Оперативные сроки поставки под заказ (от 5 рабочих дней);
- Экспресс доставка в любую точку России;
- Помощь Конструкторского Отдела и консультации квалифицированных инженеров;
- Техническая поддержка проекта, помощь в подборе аналогов, поставка прототипов;
- Поставка электронных компонентов под контролем ВП;
- Система менеджмента качества сертифицирована по Международному стандарту ISO 9001;
- При необходимости вся продукция военного и аэрокосмического назначения проходит испытания и сертификацию в лаборатории (по согласованию с заказчиком);
- Поставка специализированных компонентов военного и аэрокосмического уровня качества (Xilinx, Altera, Analog Devices, Intersil, Interpoint, Microsemi, Actel, Aeroflex, Peregrine, VPT, Syfer, Eurofarad, Texas Instruments, MS Kennedy, Miteq, Cobham, E2V, MA-COM, Hittite, Mini-Circuits, General Dynamics и др.);

Компания «Океан Электроники» является официальным дистрибьютором и эксклюзивным представителем в России одного из крупнейших производителей разъемов военного и аэрокосмического назначения «JONHON», а так же официальным дистрибьютором и эксклюзивным представителем в России производителя высокотехнологичных и надежных решений для передачи СВЧ сигналов «FORSTAR».



JONHON

«JONHON» (основан в 1970 г.)

Разъемы специального, военного и аэрокосмического назначения:

(Применяются в военной, авиационной, аэрокосмической, морской, железнодорожной, горно- и нефтедобывающей отраслях промышленности)

«FORSTAR» (основан в 1998 г.)

ВЧ соединители, коаксиальные кабели, кабельные сборки и микроволновые компоненты:

(Применяются в телекоммуникациях гражданского и специального назначения, в средствах связи, РЛС, а так же военной, авиационной и аэрокосмической отраслях промышленности).



Телефон: 8 (812) 309-75-97 (многоканальный)

Факс: 8 (812) 320-03-32

Электронная почта: ocean@oceanchips.ru

Web: <http://oceanchips.ru/>

Адрес: 198099, г. Санкт-Петербург, ул. Калинина, д. 2, корп. 4, лит. А