

RoHS  **SMOV25S Varistor Series**

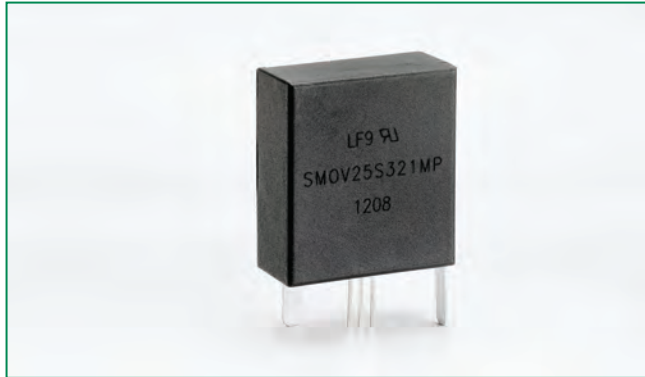

**Agency Approvals**

Agency	Agency File Number
	E320116

**Description**

The Littelfuse SMOV thermally protected varistor is a self-protected device. It consists of a 25mm square varistor with an integral thermal disconnect designed to open in the event of overheating due to abnormal overvoltage as outlined in UL1449 3rd edition. The SMOV helps facilitate SPD module compliance to UL1449 and offers quick thermal response due to the close proximity of the integrated thermal element to the MOV body. This configuration also offers lower inductance than most discreet solutions resulting in improved clamping performance to fast over voltage transients.

The device has a separate micro-switch, which can be used to indicate that the MOV has been disconnected from the circuit. This separate switch makes the monitoring circuitry completely isolated from the main power which ensures indicator circuit safety and simplifies the customers circuit design.

**Features**

- Maximum single surge capability 20 kA, 8/20 waveshape.
- Nominal Discharge Current Value: 10kA.
- Intermediate current rating: 50A/150A.
- -45°C to +75°C operating temperature.
- Recognized to UL 1449 3rd edition.
- Lead-Free and RoHS compliant.
- Integrated micro-switch for indication circuitry/design.

**Applications**

- SPD applications
- AC/DC distribution
- IT/Data center
- Power supplier
- Telecommunication

SMOV25S Series

### Absolute Maximum Ratings

• For ratings of individual members of a series, see Device Ratings and Specifications chart.

	SMOV25S Series	Units
<b>Continuous:</b>		
<b>Steady State Applied Voltage:</b>		
DC Voltage Range (VM(DC))	150 to 970	V
AC Voltage Range (VM(AC)RMS)	115 to 750	V
<b>Transient:</b>		
Non-Repetitive Surge Current, 8/20µs Waveform (ITM)	20,000	A
Non-Repetitive Energy Capability, 2ms Waveform (WTM)	170 to 670	J
Operating Ambient Temperature Range (TA)	-45 to +75	°C
Storage Temperature Range (TSTG)	-45 to +85	°C
Hi-Pot Encapsulation (Isolation Voltage Capability)	2500	V
Isolation Voltage Capability (when the thermal disconnect opens)	1500	V
Housing Insulation Resistance	>1,000	MΩ

CAUTION: Stresses above those listed in "Absolute Maximum Ratings" may cause permanent damage to the device. This is a stress only rating and operation of the device at these or any other conditions above those indicated in the operational sections of this specification is not implied.

### Device Ratings & Specifications

Part Number	Maximum Rating (75°C)					Specifications (25 °C)				
	Continuous		Transient			Varistor Voltage at 1mA Test Current		Maximum Clamping Voltage 8/20µs		Typical Capacitance f = 1MHz
	AC Volts	DC Volts	Energy 2ms	Peak Surge Current 8/20µs	Nominal Discharge Current (In)					
	VM(AC)	VM(DC)	WTM	ITM 1 x Pulse	In	VN(DC) Min	VN(DC) Max	Vc	IPK	C
(V)	(V)	(J)	(A)	(A)	(V)	(V)	(V)	(A)	(pF)	
SMOV25S111MP	115	150	170	20000	10000	162	198	295	100	3200
SMOV25S131MP	130	170	190	20000	10000	184	226	335	100	2800
SMOV25S151MP	150	200	220	20000	10000	216	264	390	100	2300
SMOV25S181MP	175	225	250	20000	10000	243	297	450	100	1900
SMOV25S251MP	250	320	330	20000	10000	351	429	640	100	1400
SMOV25S271MP	275	350	350	20000	10000	387	473	700	100	1250
SMOV25S301MP	300	385	370	20000	10000	423	517	765	100	1150
SMOV25S321MP	320	420	390	20000	10000	459	561	825	100	1080
SMOV25S421MP	420	560	460	20000	10000	612	748	1100	100	820
SMOV25S461MP	460	615	490	20000	10000	675	825	1220	100	750
SMOV25S511MP	510	670	520	20000	10000	738	902	1335	100	680
SMOV25S551MP	550	745	550	20000	10000	819	1001	1475	100	630
SMOV25S751MP	750	970	670	20000	10000	1080	1320	1950	100	460

Average power dissipation of transients should not exceed 1.5 watts

Same ratings and specifications apply to Non Isolated Monitored Switch alternative design. Replace "M" with "N" in the part number. e.g.: SMOV25S111NP.

Refer to Part Number System at the end of this document.

**Thermal Characteristics**

Typical time to open circuit under UL 1449 Abnormal Overvoltage Limited Current Test:

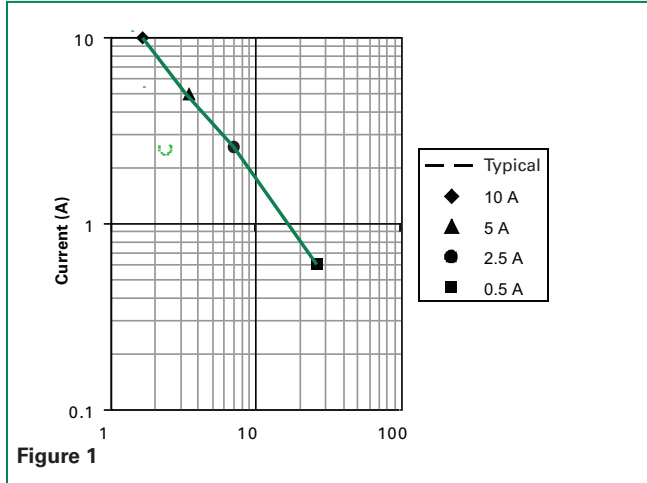

Figure 1

**Peak Current & Energy Derating Curve**

For applications exceeding 75°C ambient temperature, the peak surge current and energy ratings must be reduced as shown below.

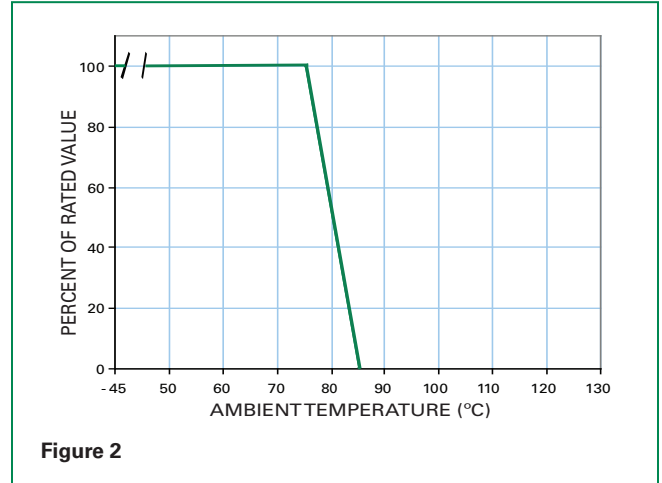

Figure 2

**Transient V-I Characteristic Curves**

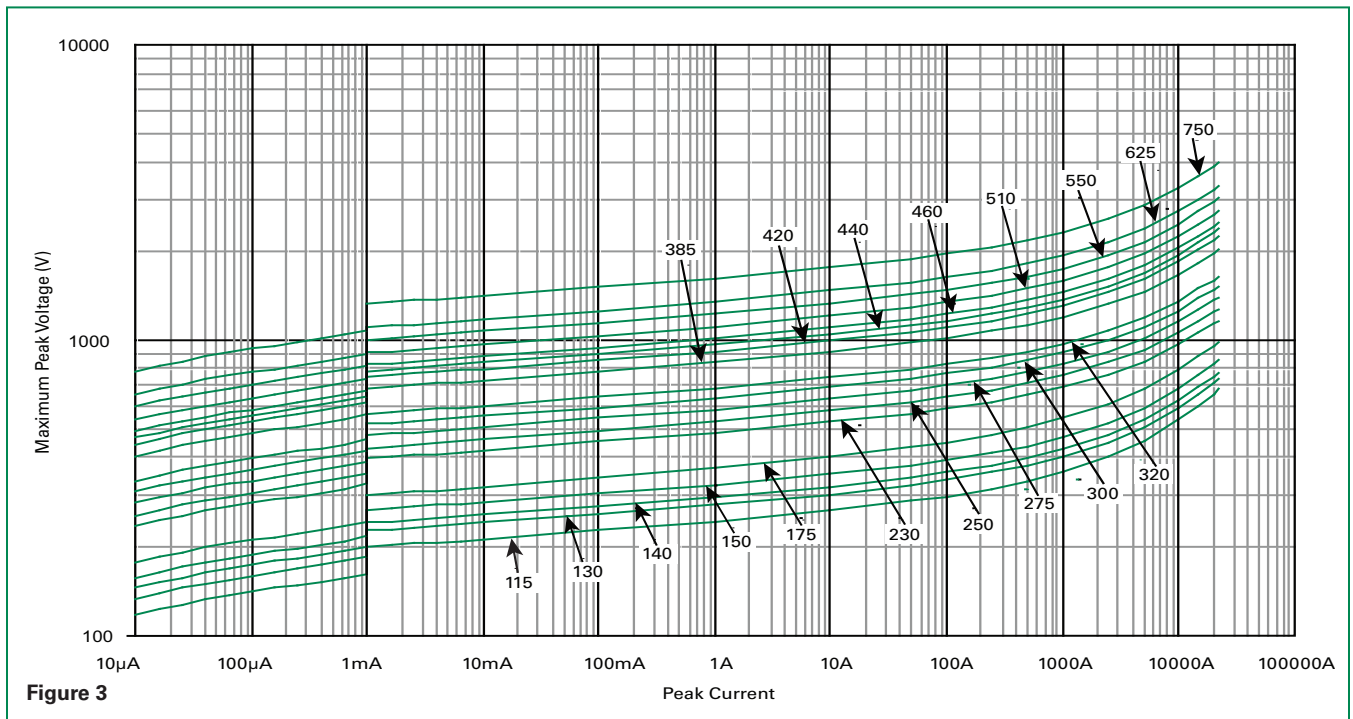

Figure 3

SMOV25S Series

### SMOV25S Pulse Rating Curve



Figure 4

### Wave Solder Profile

Because the SMOV25S Series varistors contain a thermal protection device, care must be taken when soldering the devices into place. Two soldering methods are possible. Firstly, hand soldering:

It is recommended to heat-sink the leads of the device. Secondly, wave-soldering: It is critically important that all preheat stage and the solder bath temperatures are rigidly controlled.

### Non Lead-free Profile

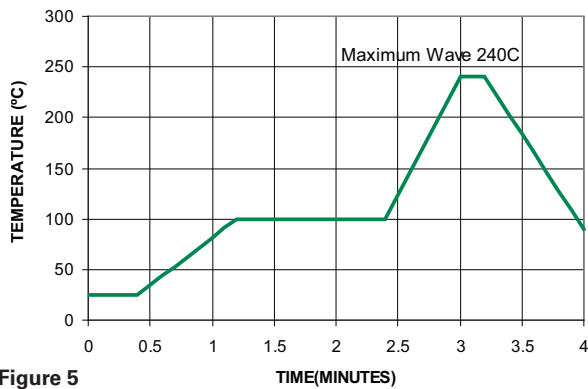

Figure 5

### Lead-free Profile

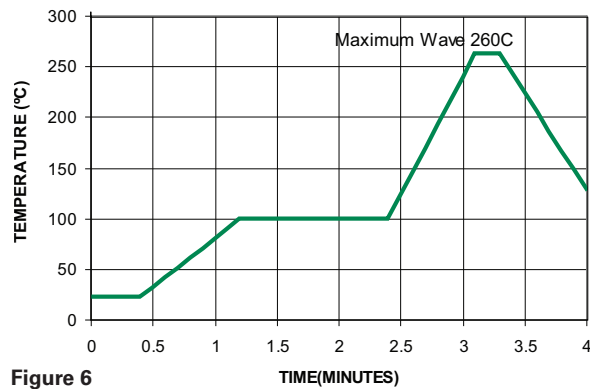

Figure 6

### Physical Specifications

<b>Lead Material</b>	Tin-coated Copper wire
<b>Soldering Characteristics</b>	Solderability per MIL-STD-202, Method 208E
<b>Insulating Material</b>	Cured, flame retardant epoxy polymer meets UL94V-0 requirements
<b>Device Labeling</b>	Marked with LF, voltage, UL logos, and date code

### Environmental Specifications

<b>Operating/Storage Temp.</b>	-45°C to +75°C / -45°C to +85°C
<b>Passive Aging</b>	+75°C, 1000 hours -/+10% typical voltage change
<b>Humidity Aging</b>	+75°C, 85%R.H., 1000 hours -/+10% typical voltage change
<b>Thermal Shock</b>	+75°C to -40°C 5 times -/+10% typical voltage change
<b>Solvent Resistance</b>	MIL-STD-202, Method 215F
<b>Moisture Sensitivity</b>	Level 1, J-STD-020C

**Product Dimensions**



**Lead Configuration**



**SMOV25S Series**

**Application Example**

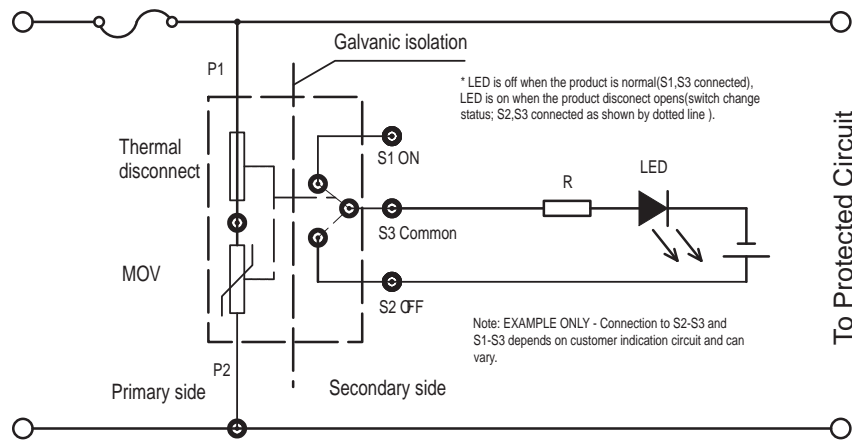

**Switch Specification**

SMOV Switch	Voltage DC	Current (Amps)	Contact Resistance Max.	Insulation Resistance Min.	Dielectric Strength 0.5mA/Minute
Switch	12V	0.1A	70mΩ	100MΩ	500VAC

### Part Numbering System



### Part Marking System



### Term Definitions

#### Rated AC Voltage ( $V_{M(AC)RMS}$ ) – MCOV

This is the maximum continuous sinusoidal RMS voltage that may be applied. This voltage may be applied at any temperature up to the maximum operating temperature of the device.

#### Maximum Non-Repetitive Surge Current ( $I_{TM}$ )

This is the maximum peak current which may be applied for a single 8/20 $\mu$ s impulse, with rated line voltage also applied, without causing device failure. The pulse can be applied to the device in either polarity with the same confidence factor.

#### Nominal Discharge Current ( $I_N$ )

Peak value of the current, selected by the manufacturer, through the SPD having a current waveshape of 8/20 $\mu$ s where the SPD remains functional after 15 surges.

#### Voltage Protection Rating ( $V_{PR}$ )

A rating selected from a list of preferred values as given in UL 1449 and assigned to each mode of protection. The value of VPR is determined as the nearest highest value taken from UL 1449 to the measured limiting voltage determined during the transient-voltage surge suppression test using the combination wave generator at a setting of 6kV, 3kA.

#### UL 1449

An Underwriters Laboratory standard covering the safety requirements for Surge Protective Devices intended for permanently connected, cord-connected and direct plug-in applications.

#### Limited Current Abnormal Over-voltage Test

An AC over-voltage condition applied to a Surge Protective Device according to UL 1449, Section 39.4. The short circuit current is limited by series connected resistors to 10A, 5A, 2.5A, 0.5A and 0.125A. The condition is maintained for 7 hours or until the device under test is disconnected from the AC supply or the current or temperature reaches equilibrium.

#### Maximum Non-Repetitive Surge Energy ( $W_{TM}$ )

This is the maximum rated transient energy which may be dissipated for a single current pulse at a specified impulse duration, with the rated RMS voltage applied, without causing device failure.

#### Nominal Voltage ( $V_{N(DC)}$ )

This is the voltage at which the device changes from the off (standby state) to the on (clamping state) and enters its conduction mode of operation. The voltage value is usually characterised at the 1mA point and has a specified minimum and maximum voltage range.

Компания «Океан Электроники» предлагает заключение долгосрочных отношений при поставках импортных электронных компонентов на взаимовыгодных условиях!

Наши преимущества:

- Поставка оригинальных импортных электронных компонентов напрямую с производств Америки, Европы и Азии, а так же с крупнейших складов мира;
- Широкая линейка поставок активных и пассивных импортных электронных компонентов (более 30 млн. наименований);
- Поставка сложных, дефицитных, либо снятых с производства позиций;
- Оперативные сроки поставки под заказ (от 5 рабочих дней);
- Экспресс доставка в любую точку России;
- Помощь Конструкторского Отдела и консультации квалифицированных инженеров;
- Техническая поддержка проекта, помощь в подборе аналогов, поставка прототипов;
- Поставка электронных компонентов под контролем ВП;
- Система менеджмента качества сертифицирована по Международному стандарту ISO 9001;
- При необходимости вся продукция военного и аэрокосмического назначения проходит испытания и сертификацию в лаборатории (по согласованию с заказчиком);
- Поставка специализированных компонентов военного и аэрокосмического уровня качества (Xilinx, Altera, Analog Devices, Intersil, Interpoint, Microsemi, Actel, Aeroflex, Peregrine, VPT, Syfer, Eurofarad, Texas Instruments, MS Kennedy, Miteq, Cobham, E2V, MA-COM, Hittite, Mini-Circuits, General Dynamics и др.);

Компания «Океан Электроники» является официальным дистрибьютором и эксклюзивным представителем в России одного из крупнейших производителей разъемов военного и аэрокосмического назначения «**JONHON**», а так же официальным дистрибьютором и эксклюзивным представителем в России производителя высокотехнологичных и надежных решений для передачи СВЧ сигналов «**FORSTAR**».



## JONHON

«**JONHON**» (основан в 1970 г.)

Разъемы специального, военного и аэрокосмического назначения:

(Применяются в военной, авиационной, аэрокосмической, морской, железнодорожной, горно- и нефтедобывающей отраслях промышленности)

«**FORSTAR**» (основан в 1998 г.)

ВЧ соединители, коаксиальные кабели,  
кабельные сборки и микроволновые компоненты:

(Применяются в телекоммуникациях гражданского и специального назначения, в средствах связи, РЛС, а так же военной, авиационной и аэрокосмической отраслях промышленности).



Телефон: 8 (812) 309-75-97 (многоканальный)

Факс: 8 (812) 320-03-32

Электронная почта: [ocean@oceanchips.ru](mailto:ocean@oceanchips.ru)

Web: <http://oceanchips.ru/>

Адрес: 198099, г. Санкт-Петербург, ул. Калинина, д. 2, корп. 4, лит. А