

Dimension

| | | | | |
|------|---|-----|---|---------------|
| L | * | W | * | H |
| 295 | * | 127 | * | 41 (1U) mm |
| 11.6 | * | 5 | * | 1.61(1U) inch |



Features

- Universal AC input / Full range (Withstand 300VAC surge input for 5 seconds)
- Built-in active PFC function
- High efficiency up to 92%
- Forced air cooling by built-in DC fan
- Output voltage programmable
- Built-in OR-ing FET, support hot swap (hot plug)
- Active current sharing up to 6000W for one 19" rack shelf
- Built-in I²C interface, PMBus protocol
- Protections: Short circuit / Overload / Over voltage / Over temperature
- Optional conformal coating
- 5 years warranty

Applications

- Industrial automation
- Distributed power architecture system
- Wireless/telecommunication solution
- Redundant power system
- Electric vehicle charger system
- Constant current source system

Description

RCP-2000 is a 2KW single output rack mountable front end AC/DC power supply with a 1U low profile and a high power density up to 25W/inch³. This series operates for 90~264VAC input voltage and offers the models with the DC output mostly demanded from the industry. Each model is cooled by the built-in DC fan with fan speed control, working for the temperature up to 70°C. RCP-2000 provides vast design flexibility by equipping various built-in functions such as the PMBus communication protocol, output programming, active current sharing (up to 18000W via three 19" rack shelves, RKP-1U), remote control, auxiliary power, alarm signal, external control/monitor via the control model RKP-CMU1, etc. Maximum number that can be monitored by master controller in communication shall be 9 power supplies.

Model Encoding / Order Information

RCP - 2000 - 24

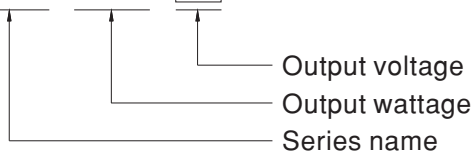

※ Note 1: 19" rack shelf, RKP-1U, available. Details available on <http://www.meanwell.com/>

※ Note 2: Control/Monitor unit, RKP-CMU1, available. Details available on <http://www.meanwell.com/>

SPECIFICATION

| MODEL | RCP-2000-12 | RCP-2000-24 | RCP-2000-48 | | |
|--------------------------------|--|---|--|--|--|
| OUTPUT | DC VOLTAGE | 12V | 24V | 48V | |
| | RATED CURRENT | 100A | 80A | 42A | |
| | CURRENT RANGE | 0 ~ 100A | 0 ~ 80A | 0 ~ 42A | |
| | RATED POWER | 1200W | 1920W | 2016W | |
| | RIPPLE & NOISE (max.) Note.2 | 150mVp-p | 200mVp-p | 300mVp-p | |
| | VOLTAGE ADJ. RANGE | 10.5 ~ 14V | 21 ~ 28V | 42 ~ 56V | |
| | VOLTAGE TOLERANCE Note.4 | ±2.0% | ±1.0% | ±1.0% | |
| | LINE REGULATION | ±1.0% | ±0.5% | ±0.5% | |
| | LOAD REGULATION | ±1.0% | ±0.5% | ±0.5% | |
| | SETUP, RISE TIME | 1500ms, 60ms/230VAC at full load | | | |
| HOLD UP TIME (Typ.) | 16ms/230VAC at 75% load 10ms/230VAC at full load | | | | |
| INPUT | VOLTAGE RANGE Note.5,6 | 90 ~ 264VAC 127 ~ 320VDC | | | |
| | FREQUENCY RANGE | 47 ~ 63Hz | | | |
| | POWER FACTOR (Typ.) | 0.98/230VAC at full load | | | |
| | EFFICIENCY (Typ.) | 86% | 90.5% | 92% | |
| | AC CURRENT (Typ.) | 13A/115VAC 7A/230VAC | 16A/115VAC 10A/230VAC | 16A/115VAC 10A/230VAC | |
| | INRUSH CURRENT (Typ.) | COLD START 50A | | | |
| | LEAKAGE CURRENT | <1.1mA / 230VAC | | | |
| PROTECTION | OVERLOAD | 105 ~ 125% rated output power Protection type : Constant current limiting, unit will shut down o/p voltage after 5 sec. re-power on to recover | | | |
| | OVER VOLTAGE | 14.7 ~ 17.5V | 29.5 ~ 35V | 57.6 ~ 67.2V | |
| | OVER TEMPERATURE | Shut down o/p voltage, recovers automatically after temperature goes down | | | |
| | FUNCTION | AUXILIARY POWER 5V @ 0.3A, 12V @ 0.8A | | | |
| FUNCTION | REMOTE ON-OFF CONTROL | Please refer to the Function Manual | | | |
| | REMOTE SENSE | Compensate voltage drop on the load wiring up to 0.5V | | | |
| | OUTPUT VOLTAGE PROGRAMMABLE | Adjustment of output voltage is allowable to 90 ~ 110% of nominal output voltage. Please refer to the Function Manual. | | | |
| | DC OK SIGNAL | The isolated TTL signal out, Please refer to the Installation Manual | | | |
| | AC OK SIGNAL | The isolated TTL signal out, Please refer to the Installation Manual | | | |
| | OVER TEMP WARNING | Logic " High" for over temperature warning, Please refer to the Installation Manual, isolated signal | | | |
| | FAN FAIL SIGNAL | The isolated TTL signal out, Please refer to the Installation Manual | | | |
| | ENVIRONMENT | WORKING TEMP. | -40 ~ +70°C (Refer to "Derating Curve") | | |
| WORKING HUMIDITY | | 20 ~ 90% RH non-condensing | | | |
| STORAGE TEMP., HUMIDITY | | -40 ~ +85°C, 10 ~ 95% RH non-condensing | | | |
| TEMP. COEFFICIENT | | ±0.03%/°C (0 ~ 50°C) | | | |
| VIBRATION | | 10 ~ 500Hz, 2G 10min./1cycle, 60min. each along X, Y, Z axes | | | |
| SAFETY & EMC (Note 7) | | SAFETY STANDARDS | UL62368-1, CSA C22.2 No. 62368-1, TUV EN62368-1, EAC TP TC 004 approved | | |
| | WITHSTAND VOLTAGE | I/P-O/P:3KVAC I/P-FG:2KVAC O/P-FG:0.7KVDC | | | |
| | ISOLATION RESISTANCE | I/P-O/P, I/P-FG, O/P-FG:100M Ohms / 500VDC / 25°C / 70% RH | | | |
| | EMC EMISSION | Parameter | Standard | Test Level / Note | |
| | | Conducted | EN55032 (CISPR32) | Class B | |
| | | Radiated | EN55032 (CISPR32) | Class A | |
| | | Harmonic Current | EN61000-3-2 | ----- | |
| | | Voltage Flicker | EN61000-3-3 | ----- | |
| | EMC IMMUNITY | EN55024, EN61204-3, EN61000-6-2 | | | |
| | | Parameter | Standard | Test Level / Note | |
| | | ESD | EN61000-4-2 | Level 3, 8KV air ; Level 2, 4KV contact | |
| | | Radiated | EN61000-4-3 | Level 3 | |
| | | EFT / Burst | EN61000-4-4 | Level 3 | |
| | | Surge | EN61000-4-5 | Level 4, 4KV/Line-Earth ; Level 3, 2KV/Line-Line | |
| Conducted | | EN61000-4-6 | Level 3 | | |
| Magnetic Field | | EN61000-4-8 | Level 4 | | |
| Voltage Dips and Interruptions | | EN61000-4-11 | >95% dip 0.5 periods, 30% dip 25 periods, >95% interruptions 250 periods | | |
| OTHERS | MTBF | 145.1K hrs min. Telcordia SR-332 (Bellcore) ; 37.4K hrs min. MIL-HDBK-217F (25°C) | | | |
| | DIMENSION | 295*127*41mm (L*W*H) | | | |
| | PACKING | 2Kg; 6pcs/13Kg/1.04CUFT | | | |
| NOTE | <p>1. All parameters NOT specially mentioned are measured at 230VAC input, rated load and 25°C of ambient temperature.</p> <p>2. Ripple & noise are measured at 20MHz of bandwidth by using a 12" twisted pair-wire terminated with a 0.1uf & 47uf parallel capacitor.</p> <p>3. Under parallel operation of more than one rack connecting together, ripple of the output voltage may be higher than the SPEC at light load condition. It will go back to normal ripple level once the output load is more than 10%.</p> <p>4. Tolerance : includes set up tolerance, line regulation and load regulation.</p> <p>5. Derating may be needed under low input voltages. Please check the static characteristics for more details.</p> <p>6. Please contact MEANWELL for 320~370VDC application.</p> <p>7. The power supply is considered a component which will be installed into a final equipment. All the EMC tests are been executed by mounting the unit on a 720mm*360mm metal plate with 1mm of thickness. The final equipment must be re-confirmed that it still meets EMC directives. For guidance on how to perform these EMC tests, please refer to "EMI testing of component power supplies." (as available on http://www.meanwell.com)</p> <p>8. The ambient temperature derating of 3.5°C/1000m with fanless models and of 5°C/1000m with fan models for operating altitude higher than 2000m(6500ft).</p> | | | | |

Block Diagram

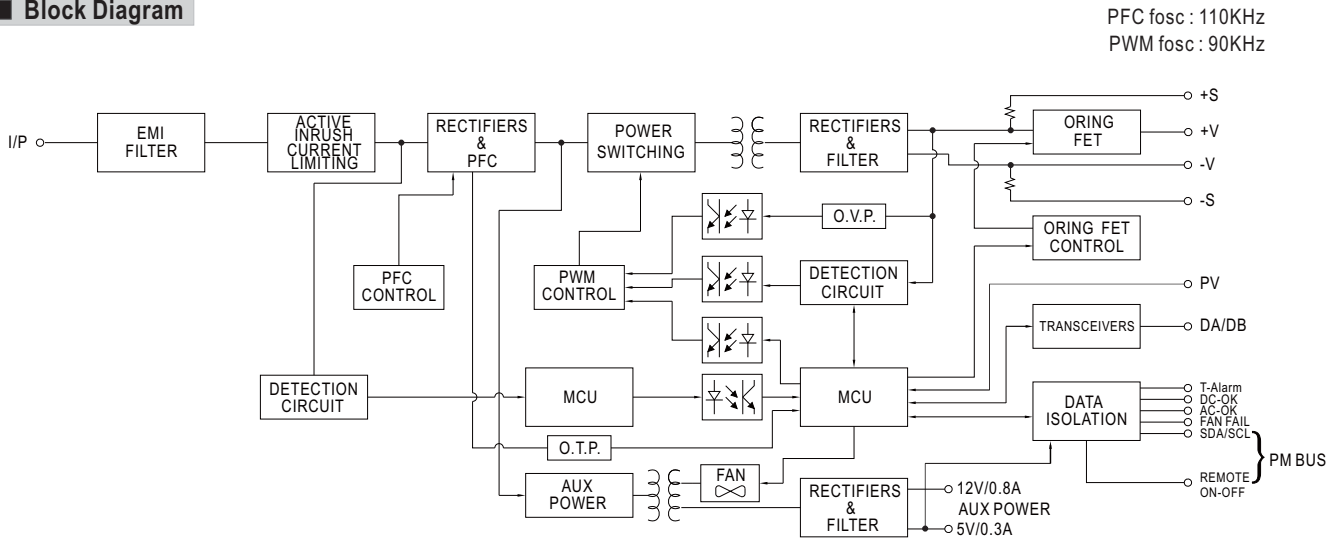

Static Characteristics

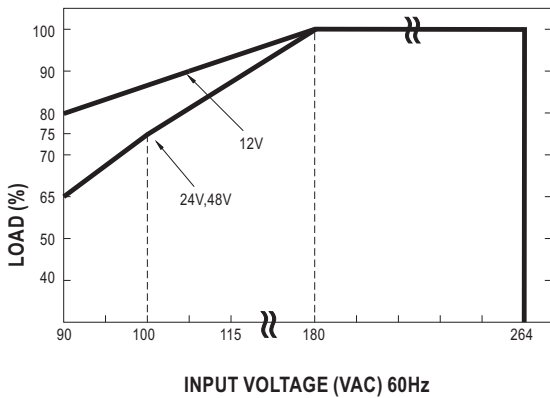

Derating Loads vs Input Voltage

| INPUT \ MODEL | 12V | 24V | 48V |
|---------------|---------------|--------------|------------------|
| 180~264VAC | 1200W 100A | 1920W 80A | 2016W 42A |
| 115VAC | 1080W 90A | 1632W 68A | 1713.6W 35.7A |
| 100VAC | 1020W 85A | 1440W 60A | 1512W 31.5A |
| 90VAC | 960W 80A | 1248W 52A | 1310.4W 27.3A |

Derating Curve

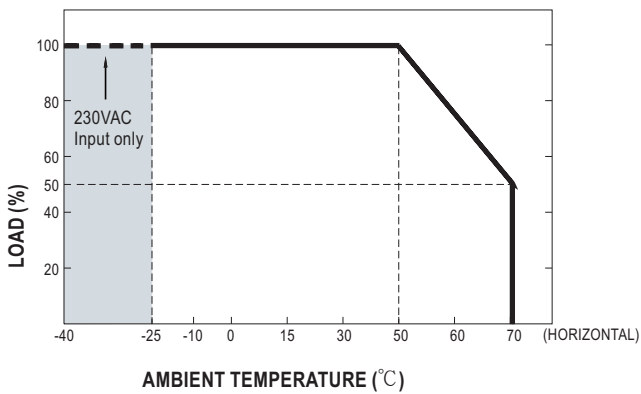

Efficiency vs Load (48V Model)

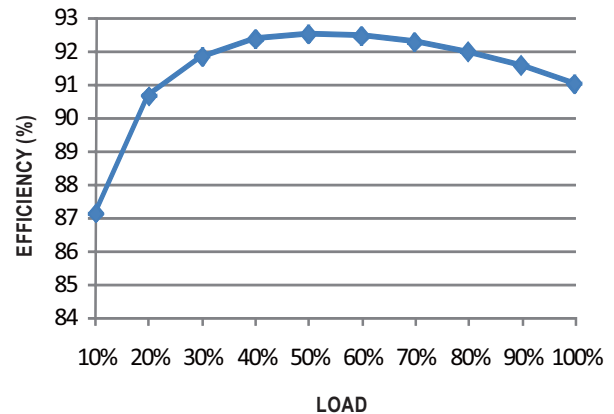

© The curve above is measured at 230VAC.

Function Manual

1. Voltage Drop Compensation

1.1 Remote Sense

※ The Remote Sense compensates voltage drop on the load wiring up to 0.5V

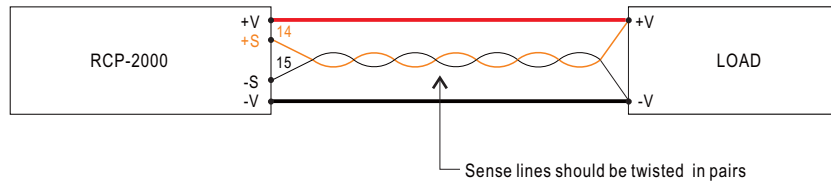

1.2 Local Sense

※ The +S, -S have to be connected to the +V(signal), -V(signal), respectively, as the following diagram, in order to get the correct output voltage if Remote Sense is not used.

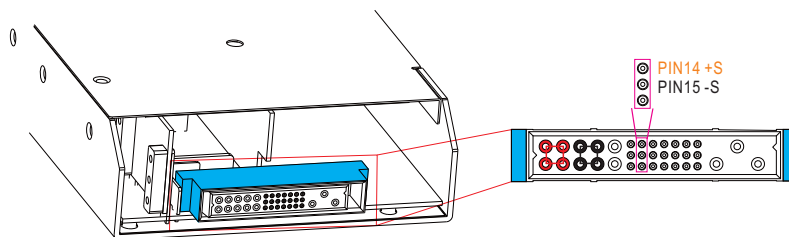
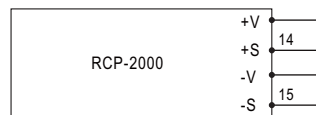

2. Output Voltage Programming (or, PV / remote voltage programming / remote adjust / margin programming / dynamic voltage trim)

※ In addition to the adjustment via the built-in potentiometer, the output voltage can be trimmed to 90~110% of the nominal voltage by applying EXTERNAL VOLTAGE.

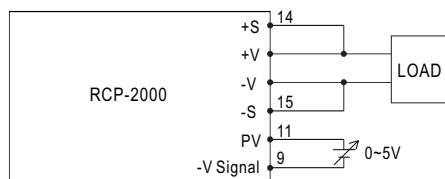

◎ +S & +V, -S & -V also need to be connected on CN501

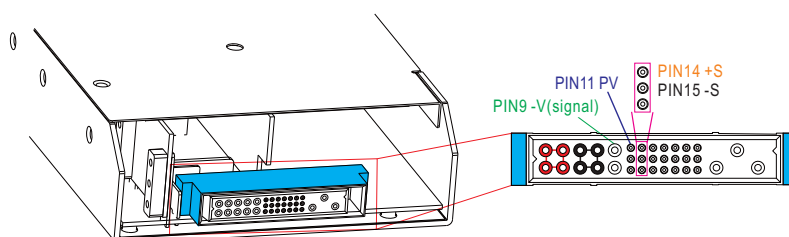
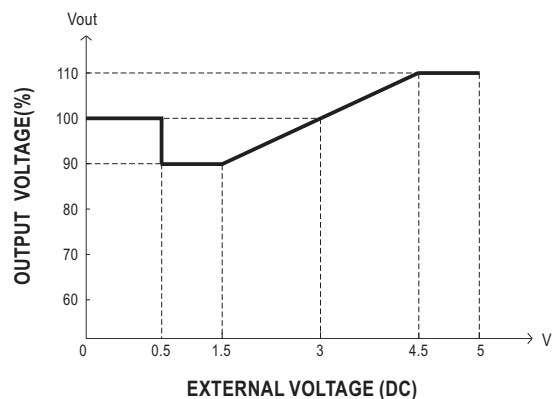

3. Remote ON-OFF Control

The power supply can be turned ON/OFF together or separately by using the "Remote ON/OFF" function.

| Between <i>Remote ON-OFF</i> and <i>+5V-AUX</i> | Power Supply Status |
|---|---------------------|
| Switch Short | ON |
| Switch Open | OFF |

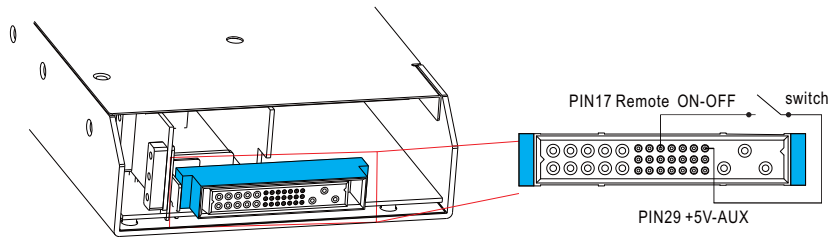

4.PMBus Communication Interface

※ RCP-2000 supports PMBus Rev. 1.1 with maximum 100KHz bus speed, allowing information reading, status monitoring and output trimming. For details, please refer to the Installation Manual.

Mechanical Specification

Case No. 974A Unit:mm

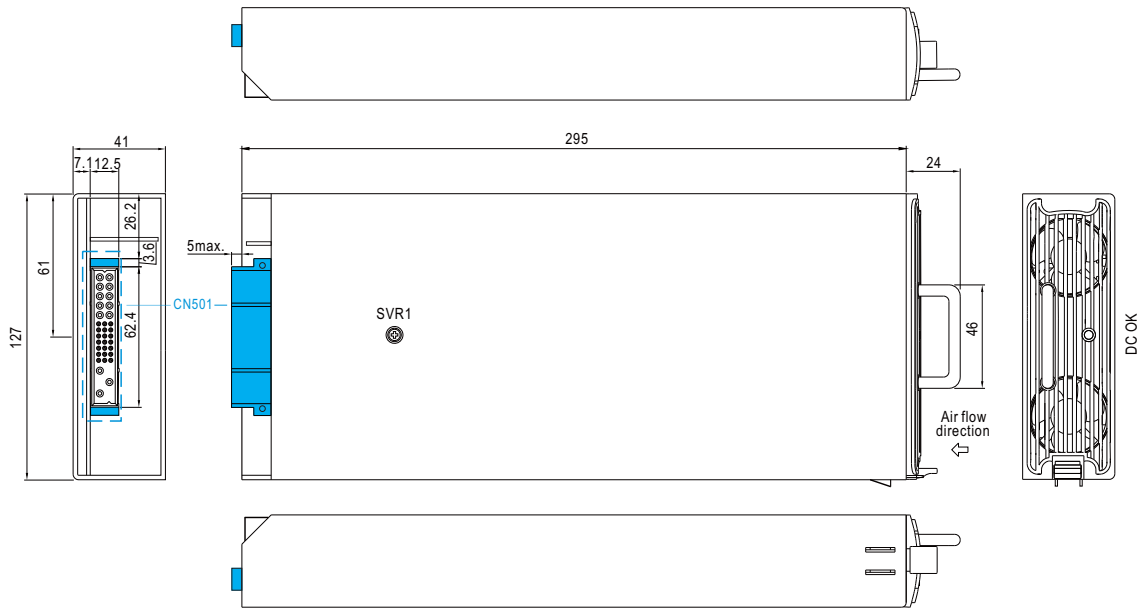

LED Status Indicators & Corresponding Signal at Function Pins

| Function | LED | Description | * Signal | Power Supply |
|----------|-------|--|------------|--------------|
| AC-OK | GREEN | When input voltage $\geq 87V$ | 0 ~ 0.5V | ON |
| AC-NG | RED | When input voltage $\leq 75V$ | 4.5 ~ 5.5V | OFF |
| DC-OK | GREEN | When output voltage $\geq 80\% \pm 5\%$ of V_o rated. | 0 ~ 0.5V | ON |
| DC-NG | RED | When output voltage $\leq 80\% \pm 5\%$ of V_o rated. | 4.5 ~ 5.5V | ON |
| T-OK | GREEN | When the internal temperature (TSW1 & TSW2 short) is within safe limit | 0 ~ 0.5V | ON |
| T-ALARM | RED | When the internal temperature (TSW1 or TSW2 open) exceeds the limit of temperature alarm | 4.5 ~ 5.5V | OFF |

*Signal between function pin and "GND-AUX".

Input / Output Connector Pin No. Assignment(CN501) : Positronic PCIM34W13M400A1

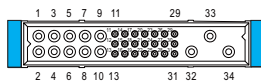

Mating Housing Positronic PCIM34W13F400A1

| Pin No. | Function | Description |
|----------------|----------------|--|
| 1,2,3,4 | +V | Positive output terminal. |
| 5,6,7,8 | -V | Negative output terminal. |
| 9 | -V(Signal) | Negative output voltage signal. For local sense only ; it cannot be connected directly to the load. |
| 10 | +V(Signal) | Positive output voltage signal. For local sense only ; it cannot be connected directly to the load. |
| 11 | PV | Connection for output voltage programming. (Note.1) |
| 12,13 | DA,DB | Differential digital signal for parallel control. (Note.1) |
| 14 | +S | Positive sensing for remote sense. |
| 15 | -S | Negative sensing for remote sense. |
| 16,18,19,20,21 | A0,A1,A2,A3,A4 | PMBus interface address lines. (Note.1) |
| 17 | Remote ON-OFF | The unit can turn the output on and off by electrical signal or dry contact between <i>Remote ON-OFF</i> and +5V-AUX. (Note.2) Short (4.5 ~ 5.5V) : Power ON ; Open (0 ~ 0.5V) : Power OFF ; The maximum input voltage is 5.5V. |
| 22 | NC | Retain for future use. |
| 23 | SDA | Serial Data used in the PMBus interface. (Note.2) |
| 24 | SCL | Serial Clock used in the PMBus interface. (Note.2) |
| 25 | AC-OK | Low (0 ~ 0.5V) : When the input voltage is $\geq 87V_{rms}$. High (4.5 ~ 5.5V) : When the input voltage in $\leq 75V_{rms}$. The maximum sourcing current is 10mA and only for output. (Note.2) |
| 26 | DC-OK | High (4.5 ~ 5.5V) : When the $V_{out} \leq 80\% \pm 5\%$. Low (0 ~ 0.5V) : When $V_{out} \geq 80\% \pm 5\%$. The maximum sourcing current is 10mA and only for output. (Note.2) |
| 27 | T-ALARM | High (4.5 ~ 5.5V) : When the internal temperature (TSW1 or TSW2 open) exceeds the limit of temperature alarm. Low (0 ~ 0.5V) : When the internal temperature (TSW1 or TSW2 short) under the limit temperature. The maximum sourcing current is 10mA and only for output.(Note.2) |
| 28 | FAN-FAIL | High (4.5 ~ 5.5V) : When the internal fan fail. Low (0 ~ 0.5V) : When the internal fan is normal. The maximum sourcing current is 10mA and only for output.(Note.2) |
| 29 | +5V-AUX | Auxiliary voltage output, 4.5~5.5V, referenced to GND-AUX (pin 31). The maximum load current is 0.3A. This output has the built-in "Oring diodes" and is not controlled by the remote ON/OFF control. |
| 30 | +12V-AUX | Auxiliary voltage output, 10.8~13.2V, referenced to GND-AUX (pin 31). The maximum load current is 0.8A. This output has the built-in "Oring diodes" and is not controlled by the remote ON/OFF control. |
| 31 | GND-AUX | Auxiliary voltage output GND. The signal return is isolated from the output terminals (+V & -V). |
| 32 | FG | AC Ground connection. |
| 33 | AC/L | AC Line connection. |
| 34 | AC/N | AC Neutral connection. |

Note1: Non-isolated signal, referenced to -V(signal).

Note2: Isolated signal, referenced to GND-AUX.

Компания «Океан Электроники» предлагает заключение долгосрочных отношений при поставках импортных электронных компонентов на взаимовыгодных условиях!

Наши преимущества:

- Поставка оригинальных импортных электронных компонентов напрямую с производств Америки, Европы и Азии, а так же с крупнейших складов мира;
- Широкая линейка поставок активных и пассивных импортных электронных компонентов (более 30 млн. наименований);
- Поставка сложных, дефицитных, либо снятых с производства позиций;
- Оперативные сроки поставки под заказ (от 5 рабочих дней);
- Экспресс доставка в любую точку России;
- Помощь Конструкторского Отдела и консультации квалифицированных инженеров;
- Техническая поддержка проекта, помощь в подборе аналогов, поставка прототипов;
- Поставка электронных компонентов под контролем ВП;
- Система менеджмента качества сертифицирована по Международному стандарту ISO 9001;
- При необходимости вся продукция военного и аэрокосмического назначения проходит испытания и сертификацию в лаборатории (по согласованию с заказчиком);
- Поставка специализированных компонентов военного и аэрокосмического уровня качества (Xilinx, Altera, Analog Devices, Intersil, Interpoint, Microsemi, Actel, Aeroflex, Peregrine, VPT, Syfer, Eurofarad, Texas Instruments, MS Kennedy, Miteq, Cobham, E2V, MA-COM, Hittite, Mini-Circuits, General Dynamics и др.);

Компания «Океан Электроники» является официальным дистрибьютором и эксклюзивным представителем в России одного из крупнейших производителей разъемов военного и аэрокосмического назначения «JONHON», а так же официальным дистрибьютором и эксклюзивным представителем в России производителя высокотехнологичных и надежных решений для передачи СВЧ сигналов «FORSTAR».



JONHON

«JONHON» (основан в 1970 г.)

Разъемы специального, военного и аэрокосмического назначения:

(Применяются в военной, авиационной, аэрокосмической, морской, железнодорожной, горно- и нефтедобывающей отраслях промышленности)

«FORSTAR» (основан в 1998 г.)

ВЧ соединители, коаксиальные кабели,
кабельные сборки и микроволновые компоненты:

(Применяются в телекоммуникациях гражданского и специального назначения, в средствах связи, РЛС, а так же военной, авиационной и аэрокосмической отраслях промышленности).



Телефон: 8 (812) 309-75-97 (многоканальный)

Факс: 8 (812) 320-03-32

Электронная почта: ocean@oceanchips.ru

Web: <http://oceanchips.ru/>

Адрес: 198099, г. Санкт-Петербург, ул. Калинина, д. 2, корп. 4, лит. А