

Bluetooth Module Evaluation Board

ABBTM-2.4GHz-EVAL

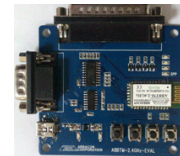

RoHS
Compliant



74.0 x 68.0 mm

DEVICE FEATURES:

This Evaluation Board contains Abracon's ABBTM-2.4GHz Bluetooth Module, status LEDs, buttons, interfaces and power regulator. The ABBTM-2.4GHz device features include:

- Bluetooth Spec v2.0+EDR Compliant
- CSR BlueCore4 built-in
- Class 2, up to 10-meter range
- Complete 2.4GHz Bluetooth® System
- Power management: low power 1.8V operation for Bluetooth® core
- Compact size: 26.9mm (L) x 13 (W) mm x 2.2mm (H)
- Bluetooth® Profile Supported: SPP,HSP, HFP, OPP,PBAP
- Internal antenna
- On-board flash memory (8Mbits)
- SPP profile Embedded in the module (for the software version "F5A34710040F")

APPLICATION

For ABBTM-2.4GHz Bluetooth Module - Wireless serial data transmission (SPP service). Can be used for engineering evaluation of the ABBTM-2.4GHz device

HARDWARE DESCRIPTION

- Interface: DB25 Parallel port, DB9 Serial port, USB interface
- Power Supply: +5V (from USB Port)
- UART Interface: Programmable baud rate up to 3Mbits with an optional by-pass mode
- Connectivity: Bluetooth laptop, computer and Bluetooth adapters, PDA and other devices for seamless connectivity (supports SPP service)
- Size: 74mm * 68mm

EVALUATION BOARD IMAGE

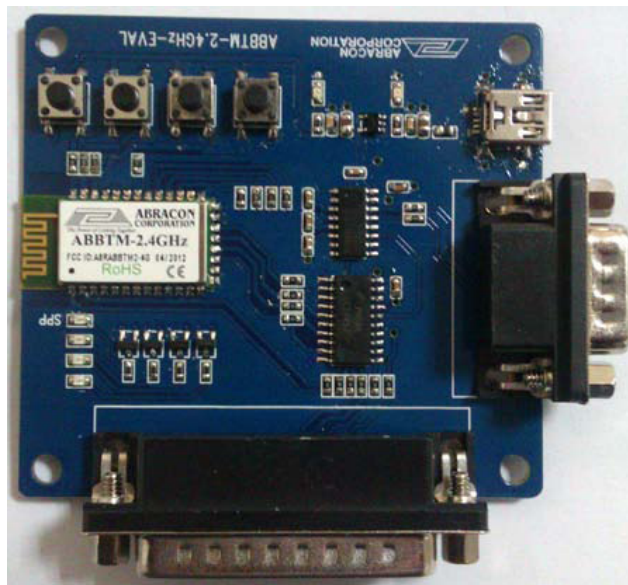

FUNCTION

This Evaluation Board is designed to program and configure, Abracon 's ABBTM-2.4GHz Bluetooth Module; already soldered on the evaluation board. The user can configure the data input and output. The ABBTM-2.4GHz-EVAL is Powered Up with a USB Interface. The user can provide bias to the evaluation board either via a USB Port of a computer, or a USB AC-DC Charger.

The ABBTM-2.4GHz Bluetooth Module soldered on the evaluation board leads to four general I/O ports; which control (4) Blue LED's used as Status Indicators. Additionally, there are (4) button inputs that lead to four general I/O ports of the ABBTM-2.4GHz Module.

ENVIRONMENTAL CONDITIONS

Parameter	Value
Operating Temperature Range	-40°C to +85°C
Storage Temperature Range	-40°C to +85°C
Relative Humidity (Operating)	≤ 90%
Relative Humidity (Storage)	≤ 90%

ABRACON IS
ISO 9001:2008
CERTIFIED



Visit www.abracon.com for Terms & Conditions of Sale
30332 Esperanza, Rancho Santa Margarita, California 92688
tel 949-546-8000 | fax 949-546-8001 | www.abracon.com

Revised: 01.26.12

Bluetooth Module Evaluation Board

ABBTM-2.4GHz-EVAL



RoHS
Compliant

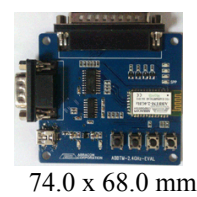

74.0 x 68.0 mm

PORT DESCRIPTION

USB Port: Power Supply only; Need a USB cable with mini-A-type and universal A-type connector.

RS232 Serial port: Wireless data input \ output Interface; Need a DB9 serial cable (crossover, female- female) connect to PC.

Parameter		Possible Values
Baud Rate	Minimum	1200 baud ($\leq 2\%$ Error)
		9600 baud ($\leq 1\%$ Error)
	Maximum	3M baud ($\leq 1\%$ Error)
Flow Control		RTS/CTS or None
Parity		None, Odd or Even
Number of Stop Bits		1 or 2
Bits per Channel		8

Note: In order to communicate with the UART at its maximum data rate using a Standard PC, an accelerated serial port adapter card is required for the PC.

Parallel port: Need a DB25 parallel cable (male-female), the female side is to be connected to the evaluation board, while the male side is to be connected to the PC.

(4) LED Lights: One of the "SPP" indicator is used for the SPP Service of the ABBTM-2.4GHz Bluetooth Module. When ABBTM-2.4GHz is not connected with the SPP service, the LED light will continue to flash. Once SPP connection is established, the LED will be continuously lit.

The other (3) LED lights are currently reserved for the software version "F5A34710040F" of the ABBTM-2.4GHz Bluetooth Module; so there is no functionality associated with them.

(4) Touch Buttons: The touch buttons currently do not have a function associated with them. They are placed as a provision for future use

BOARD DESCRIPTION

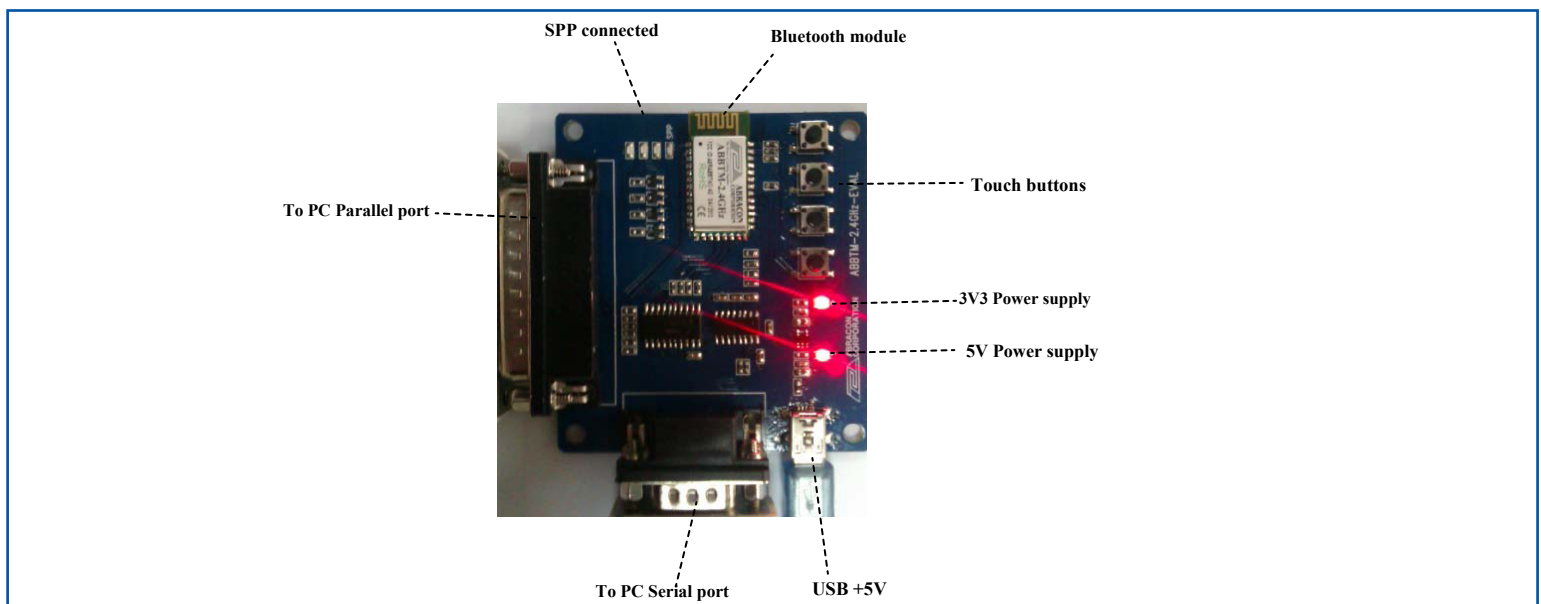

ABRACON IS
ISO 9001:2008
CERTIFIED



Visit www.abracon.com for Terms & Conditions of Sale
30332 Esperanza, Rancho Santa Margarita, California 92688
tel 949-546-8000 | fax 949-546-8001 | www.abracon.com

Revised: 01.26.12

Bluetooth Module Evaluation Board

ABBTM-2.4GHz-EVAL



RoHS
Compliant

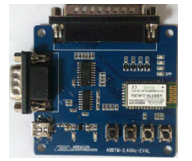

74.0 x 68.0 mm

BOARD LAYOUT AND DIMENSIONS

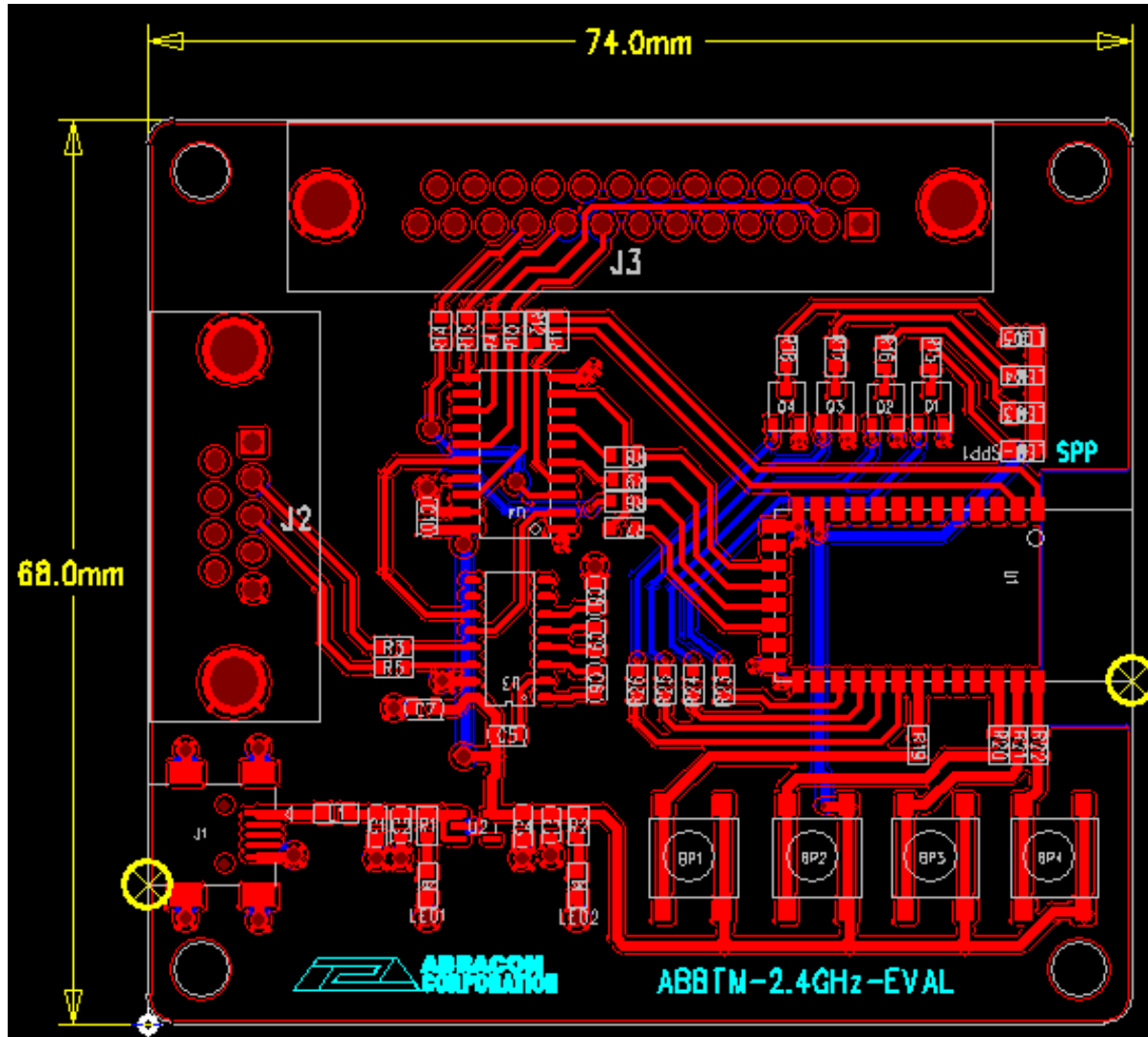

ABRACON IS
ISO 9001:2008
CERTIFIED



Visit www.abracon.com for Terms & Conditions of Sale
30332 Esperanza, Rancho Santa Margarita, California 92688
tel 949-546-8000 | fax 949-546-8001 | www.abracon.com

Revised: 01.26.12

Bluetooth Module Evaluation Board

ABBTM-2.4GHz-EVAL



RoHS
Compliant

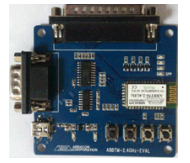

74.0 x 68.0 mm

EVALUATION BOARD USER GUIDE

Demo environment Setup: (the example for another Bluetooth SPP device is PC+BT Dongle) Demo environment Setup: (the example for another Bluetooth SPP device is PC+BT Dongle)

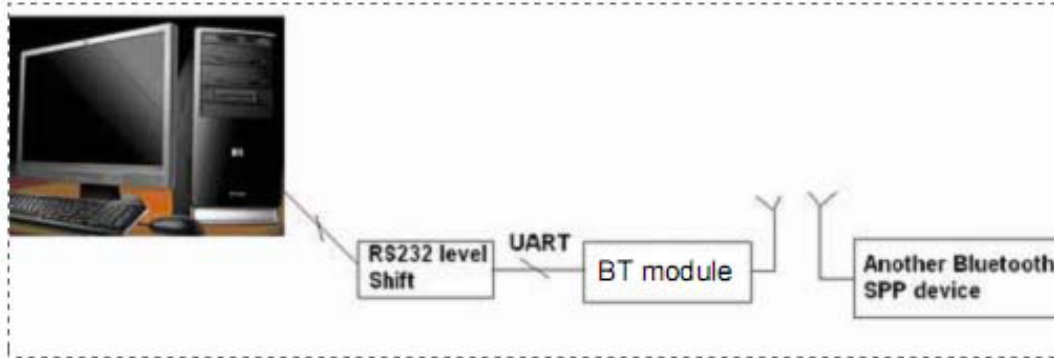

1. Connect demo board to PC serial port, such as port 1.
2. Connect USB 5V Supply, the red LED will light-up indicating that the 3v3 power supply is ready
3. Run the Bluetooth software such as IVT's BlueSoleil, to drive a Bluetooth dongle. It is another SPP device
4. Inquire the Bluetooth device and find the Device named "ABBTM"
5. Refresh the service and select the SPP service. Connect it.
6. The blue LED will light-up indicating the "SPP" connection is now setup and it acts as serial port 6
7. Open the "SerCom", and set the serial port 1.
8. Open the "Sercom" again, and set the serial port 6.
9. Send the string "Send from com6" form COM6 to COM1, and COM1 receive the string "Send from com6"
10. Send the string "SEND FROM COM1" form COM1 to COM6, and COM6 receive the string "SEND FROM COM1"

ATTENTION: Abracon Corporation's products are COTS – Commercial-Off-The-Shelf products; suitable for Commercial, Industrial and, where designated, Automotive Applications. Abracon's products are not specifically designed for Military, Aviation, Aerospace, Life-dependant Medical applications or any application requiring high reliability where component failure could result in loss of life and/or property. For applications requiring high reliability and/or presenting an extreme operating environment, written consent and authorization from Abracon Corporation is required. Please contact Abracon Corporation for more information.

ABRACON IS
ISO 9001:2008
CERTIFIED



Visit www.abracon.com for Terms & Conditions of Sale

Revised: 01.26.12

30332 Esperanza, Rancho Santa Margarita, California 92688
tel 949-546-8000 | fax 949-546-8001 | www.abracon.com

Компания «Океан Электроники» предлагает заключение долгосрочных отношений при поставках импортных электронных компонентов на взаимовыгодных условиях!

Наши преимущества:

- Поставка оригинальных импортных электронных компонентов напрямую с производств Америки, Европы и Азии, а так же с крупнейших складов мира;
- Широкая линейка поставок активных и пассивных импортных электронных компонентов (более 30 млн. наименований);
- Поставка сложных, дефицитных, либо снятых с производства позиций;
- Оперативные сроки поставки под заказ (от 5 рабочих дней);
- Экспресс доставка в любую точку России;
- Помощь Конструкторского Отдела и консультации квалифицированных инженеров;
- Техническая поддержка проекта, помощь в подборе аналогов, поставка прототипов;
- Поставка электронных компонентов под контролем ВП;
- Система менеджмента качества сертифицирована по Международному стандарту ISO 9001;
- При необходимости вся продукция военного и аэрокосмического назначения проходит испытания и сертификацию в лаборатории (по согласованию с заказчиком);
- Поставка специализированных компонентов военного и аэрокосмического уровня качества (Xilinx, Altera, Analog Devices, Intersil, Interpoint, Microsemi, Actel, Aeroflex, Peregrine, VPT, Syfer, Eurofarad, Texas Instruments, MS Kennedy, Miteq, Cobham, E2V, MA-COM, Hittite, Mini-Circuits, General Dynamics и др.);

Компания «Океан Электроники» является официальным дистрибьютором и эксклюзивным представителем в России одного из крупнейших производителей разъемов военного и аэрокосмического назначения «JONHON», а так же официальным дистрибьютором и эксклюзивным представителем в России производителя высокотехнологичных и надежных решений для передачи СВЧ сигналов «FORSTAR».



JONHON

«JONHON» (основан в 1970 г.)

Разъемы специального, военного и аэрокосмического назначения:

(Применяются в военной, авиационной, аэрокосмической, морской, железнодорожной, горно- и нефтедобывающей отраслях промышленности)

«FORSTAR» (основан в 1998 г.)

ВЧ соединители, коаксиальные кабели, кабельные сборки и микроволновые компоненты:

(Применяются в телекоммуникациях гражданского и специального назначения, в средствах связи, РЛС, а так же военной, авиационной и аэрокосмической отраслях промышленности).



Телефон: 8 (812) 309-75-97 (многоканальный)

Факс: 8 (812) 320-03-32

Электронная почта: ocean@oceanchips.ru

Web: <http://oceanchips.ru/>

Адрес: 198099, г. Санкт-Петербург, ул. Калинина, д. 2, корп. 4, лит. А