

High-Speed CAN Flexible Data Rate Transceiver

Features:

- Optimized for CAN FD (Flexible Data rate) at 2, 5 and 8 Mbps Operation
 - Maximum Propagation Delay: 120 ns
 - Loop Delay Symmetry: -10%/+10% (2 Mbps)
- Implements ISO-11898-2 and ISO-11898-5 Standard Physical Layer Requirements
- Very Low Standby Current (5 μ A, typical)
- Vio Supply Pin to Interface Directly to CAN Controllers and Microcontrollers with 1.8V to 5.5V I/O
- SPLIT Output Pin to Stabilize Common Mode in Biased Split Termination Schemes
- CAN Bus Pins are Disconnected when Device is Unpowered
 - An Unpowered Node or Brown-Out Event will Not Load the CAN Bus
- Detection of Ground Fault:
 - Permanent Dominant Detection on TXD
 - Permanent Dominant Detection on Bus
- Power-on Reset and Voltage Brown-Out Protection on VDD Pin
- Protection Against Damage Due to Short-Circuit Conditions (Positive or Negative Battery Voltage)
- Protection Against High-Voltage Transients in Automotive Environments
- Automatic Thermal Shutdown Protection
- Suitable for 12V and 24V Systems
- Meets or exceeds stringent automotive design requirements including “Hardware Requirements for LIN, CAN and FlexRay Interfaces in Automotive Applications”, Version 1.3, May 2012
 - Radiated emissions @ 2 Mbps with Common Mode Choke (CMC)
 - DPI @ 2 Mbps with CMC
- High ESD Protection on CANH and CANL, meeting IEC61000-4-2 up to \pm 14 kV
- Available in PDIP-8L, SOIC-8L and 3x3 DFN-8L
- Temperature ranges:
 - Extended (E): -40°C to +125°C
 - High (H): -40°C to +150°C

Description:

The MCP2561/2FD is a second generation high-speed CAN transceiver from Microchip Technology Inc. It offers the same features as the MCP2561/2. Additionally, it guarantees Loop Delay Symmetry in order to support the higher data rates required for CAN FD. The maximum propagation delay was improved to support longer bus length.

The device meets the automotive requirements for CAN FD bit rates exceeding 2 Mbps, low quiescent current, electromagnetic compatibility (EMC) and electrostatic discharge (ESD).

Package Types



MCP2561/2FD Family Members

Device	Feature	Description
MCP2561FD	SPLIT pin	Common mode stabilization
MCP2562FD	Vio pin	Internal level shifter on digital I/O pins

Note: For ordering information, see the “Product Identification System” section on page 29.

MCP2561/2FD

Block Diagram



1.0 DEVICE OVERVIEW

The MCP2561/2FD is a high-speed CAN device, fault-tolerant device that serves as the interface between a CAN protocol controller and the physical bus. The MCP2561/2FD device provides differential transmit and receive capability for the CAN protocol controller, and is fully compatible with the ISO-11898-2 and ISO-11898-5 standards.

The Loop Delay Symmetry is guaranteed to support data rates that are up to 5 Mbps for CAN FD (Flexible Data rate). The maximum propagation delay was improved to support longer bus length.

Typically, each node in a CAN system must have a device to convert the digital signals generated by a CAN controller to signals suitable for transmission over the bus cabling (differential output). It also provides a buffer between the CAN controller and the high-voltage spikes that can be generated on the CAN bus by outside sources.

1.1 Mode Control Block

The MCP2561/2FD supports two modes of operation:

- Normal Mode
- Standby Mode

These modes are summarized in Table 1-1.

TABLE 1-1: MODES OF OPERATION

Mode	STBY Pin	Rxd Pin	
		LOW	HIGH
Normal	LOW	Bus is Dominant	Bus is Recessive
Standby	HIGH	Wake-up request is detected	No wake-up request detected

1.2 Transmitter Function

The CAN bus has two states:

- Dominant State
- Recessive State

A Dominant state occurs when the differential voltage between CANH and CANL is greater than $V_{DIFF(D)(I)}$. A Recessive state occurs when the differential voltage is less than $V_{DIFF(R)(I)}$. The Dominant and Recessive states correspond to the Low and High state of the TXD input pin, respectively. However, a Dominant state initiated by another CAN node will override a Recessive state on the CAN bus.

1.3 Receiver Function

In Normal mode, the RXD output pin reflects the differential bus voltage between CANH and CANL. The Low and High states of the RXD output pin correspond to the Dominant and Recessive states of the CAN bus, respectively.

1.1.1 NORMAL MODE

Normal mode is selected by applying low-level voltage to the STBY pin. The driver block is operational and can drive the bus pins. The slopes of the output signals on CANH and CANL are optimized to produce minimal electromagnetic emissions (EME).

The high speed differential receiver is active.

1.1.2 STANDBY MODE

The device may be placed in Standby mode by applying high-level voltage to the STBY pin. In Standby mode, the transmitter and the high-speed part of the receiver are switched off to minimize power consumption. The low-power receiver and the wake-up filter blocks are enabled to monitor the bus for activity. The receive pin (RXD) will show a delayed representation of the CAN bus, due to the wake-up filter.

The CAN controller gets interrupted by a negative edge on the RXD pin (Dominant state on the CAN bus). The CAN controller must put the MCP2561/2FD back into Normal mode, using the STBY pin, in order to enable high speed data communication.

The CAN bus wake-up function requires both supply voltages, VDD and VIO, to be in valid range.

1.4 Internal Protection

CANH and CANL are protected against battery short-circuits and electrical transients that can occur on the CAN bus. This feature prevents destruction of the transmitter output stage during such a fault condition.

The device is further protected from excessive current loading by thermal shutdown circuitry that disables the output drivers when the junction temperature exceeds a nominal limit of +175°C. All other parts of the chip remain operational, and the chip temperature is lowered due to the decreased power dissipation in the transmitter outputs. This protection is essential to protect against bus line short-circuit-induced damage.

MCP2561/2FD

1.5 Permanent Dominant Detection

The MCP2561/2FD device prevents two conditions:

- Permanent Dominant condition on TxD
- Permanent Dominant condition on the bus

In Normal mode, if the MCP2561/2FD detects an extended Low state on the TxD input, it will disable the CANH and CANL output drivers in order to prevent the corruption of data on the CAN bus. The drivers will remain disabled until TxD goes High.

In Standby mode, if the MCP2561/2FD detects an extended Dominant condition on the bus, it will set the RxD pin to Recessive state. This allows the attached controller to go to Low-Power mode until the Dominant issue is corrected. RxD is latched High until a Recessive state is detected on the bus, and the wake-up function is enabled again.

Both conditions have a time-out of 1.25 ms (typical). This implies a maximum bit time of 69.44 μ s (14.4 kHz), allowing up to 18 consecutive dominant bits on the bus.

1.6 Power-On Reset (POR) and Undervoltage Detection

The MCP2561/2FD has undervoltage detection on both supply pins: VDD and VIO. Typical undervoltage thresholds are 1.2V for VIO and 4V for VDD.

When the device is powered on, CANH and CANL remain in a high-impedance state until both VDD and VIO exceed their undervoltage levels. Once powered on, CANH and CANL will enter a high-impedance state if the voltage level at VDD drops below the undervoltage level, providing voltage brown-out protection during normal operation.

In Normal mode, the receiver output is forced to Recessive state during an undervoltage condition on VDD. In Standby mode, the low-power receiver is only enabled when both VDD and VIO supply voltages rise above their respective undervoltage thresholds. Once these threshold voltages are reached, the low-power receiver is no longer controlled by the POR comparator and remains operational down to about 2.5V on the VDD supply (MCP2561/2FD). The MCP2562FD transfers data to the RxD pin down to 1.8V on the VIO supply.

1.7 Pin Descriptions

Table 1-2 describes the pinout.

TABLE 1-2: MCP2561/2FD PIN DESCRIPTIONS

MCP2561FD 3x3 DFN	MCP2561FD PDIP, SOIC	MCP2562FD 3x3 DFN	MCP2562FD PDIP, SOIC	Symbol	Pin Function
1	1	1	1	TxD	Transmit Data Input
2	2	2	2	VSS	Ground
3	3	3	3	VDD	Supply Voltage
4	4	4	4	RxD	Receive Data Output
5	5	—	—	SPLIT	Common Mode Stabilization - MCP2561FD only
—	—	5	5	VIO	Digital I/O Supply Pin - MCP2562FD only
6	6	6	6	CANL	CAN Low-Level Voltage I/O
7	7	7	7	CANH	CAN High-Level Voltage I/O
8	8	8	8	STBY	Standby Mode Input
9	—	9	—	EP	Exposed Thermal Pad

1.7.1 TRANSMITTER DATA INPUT PIN (TXD)

The CAN transceiver drives the differential output pins CANH and CANL according to TXD. It is usually connected to the transmitter data output of the CAN controller device. When TXD is Low, CANH and CANL are in the Dominant state. When TXD is High, CANH and CANL are in the Recessive state, provided that another CAN node is not driving the CAN bus with a Dominant state. TXD is connected to an internal pull-up resistor (nominal 33 k Ω) to VDD or VIO, in the MCP2561FD or MCP2562FD, respectively.

1.7.2 GROUND SUPPLY PIN (VSS)

Ground supply pin.

1.7.3 SUPPLY VOLTAGE PIN (VDD)

Positive supply voltage pin. Supplies transmitter and receiver, including the wake-up receiver.

1.7.4 RECEIVER DATA OUTPUT PIN (RXD)

RXD is a CMOS-compatible output that drives High or Low depending on the differential signals on the CANH and CANL pins, and is usually connected to the receiver data input of the CAN controller device. RXD is High when the CAN bus is Recessive, and Low in the Dominant state. RXD is supplied by VDD or VIO, in the MCP2561FD or MCP2562FD, respectively.

1.7.5 SPLIT PIN (MCP2561FD ONLY)

Reference Voltage Output (defined as VDD/2). The pin is only active in Normal mode. In Standby mode, or when VDD is off, SPLIT floats.

1.7.6 VIO PIN (MCP2562FD ONLY)

Supply for digital I/O pins. In the MCP2561FD, the supply for the digital I/O (TXD, RXD and STBY) is internally connected to VDD.

1.7.7 CAN LOW PIN (CANL)

The CANL output drives the Low side of the CAN differential bus. This pin is also tied internally to the receive input comparator. CANL disconnects from the bus when MCP2561/2FD is not powered.

1.7.8 CAN HIGH PIN (CANH)

The CANH output drives the high-side of the CAN differential bus. This pin is also tied internally to the receive input comparator. CANH disconnects from the bus when MCP2561/2FD is not powered.

1.7.9 STANDBY MODE INPUT PIN (STBY)

This pin selects between Normal or Standby mode. In Standby mode, the transmitter, high speed receiver and SPLIT are turned off, only the low power receiver and wake-up filter are active. STBY is connected to an internal MOS pull-up resistor to VDD or VIO, in the MCP2561FD or MCP2562FD, respectively. The value of the MOS pull-up resistor depends on the supply voltage. Typical values are 660 k Ω for 5V, 1.1 M Ω for 3.3V and 4.4 M Ω for 1.8V

1.7.10 EXPOSED THERMAL PAD (EP)

It is recommended that this pad is connected to VSS for the enhancement of electromagnetic immunity and thermal resistance.

MCP2561/2FD

1.8 Typical Applications

In order to meet the EMC/EMI requirements, a Common Mode Choke (CMC) might be required for data rates greater than 1 Mbps.

FIGURE 1-1: MCP2561FD WITH SPLIT PIN



FIGURE 1-2: MCP2562FD WITH V_{IO} PIN



2.0 ELECTRICAL CHARACTERISTICS

2.1 Terms and Definitions

A number of terms are defined in ISO-11898 that are used to describe the electrical characteristics of a CAN transceiver device. These terms and definitions are summarized in this section.

2.1.1 BUS VOLTAGE

V_{CANL} and V_{CANH} denote the voltages of the bus line wires CANL and CANH relative to ground of each individual CAN node.

2.1.2 COMMON MODE BUS VOLTAGE RANGE

Boundary voltage levels of V_{CANL} and V_{CANH} with respect to ground, for which proper operation will occur, if up to the maximum number of CAN nodes are connected to the bus.

2.1.3 DIFFERENTIAL INTERNAL CAPACITANCE, C_{DIFF} (OF A CAN NODE)

Capacitance seen between CANL and CANH during the Recessive state, when the CAN node is disconnected from the bus (see Figure 2-1).

2.1.4 DIFFERENTIAL INTERNAL RESISTANCE, R_{DIFF} (OF A CAN NODE)

Resistance seen between CANL and CANH during the Recessive state when the CAN node is disconnected from the bus (see Figure 2-1).

2.1.5 DIFFERENTIAL VOLTAGE, V_{DIFF} (OF CAN BUS)

Differential voltage of the two-wire CAN bus, value $V_{DIFF} = V_{CANH} - V_{CANL}$.

2.1.6 INTERNAL CAPACITANCE, C_{IN} (OF A CAN NODE)

Capacitance seen between CANL (or CANH) and ground during the Recessive state, when the CAN node is disconnected from the bus (see Figure 2-1).

2.1.7 INTERNAL RESISTANCE, R_{IN} (OF A CAN NODE)

Resistance seen between CANL (or CANH) and ground during the Recessive state, when the CAN node is disconnected from the bus (see Figure 2-1).

FIGURE 2-1: PHYSICAL LAYER DEFINITIONS



MCP2561/2FD

2.2 Absolute Maximum Ratings†

VDD	7.0V
VIO	7.0V
DC Voltage at TXD, RXD, STBY and VSS	-0.3V to VIO + 0.3V
DC Voltage at CANH, CANL and SPLIT	-58V to +58V
Transient Voltage on CANH, CANL (ISO-7637) (See Figure 2-5)	-150V to +100V
Storage temperature	-55°C to +150°C
Operating ambient temperature	-40°C to +150°C
Virtual Junction Temperature, Tvj (IEC60747-1)	-40°C to +190°C
Soldering temperature of leads (10 seconds)	+300°C
ESD protection on CANH and CANL pins for MCP2561FD (IEC 61000-4-2)	±14 kV
ESD protection on CANH and CANL pins for MCP2562FD (IEC 61000-4-2)	±8 kV
ESD protection on CANH and CANL pins (IEC 801; Human Body Model)	±8 kV
ESD protection on all other pins (IEC 801; Human Body Model)	±4 kV
ESD protection on all pins (IEC 801; Machine Model)	±300V
ESD protection on all pins (IEC 801; Charge Device Model)	±750V

† **NOTICE:** Stresses above those listed under “Maximum ratings” may cause permanent damage to the device. This is a stress rating only and functional operation of the device at those or any other conditions above those indicated in the operational listings of this specification is not implied. Exposure to maximum rating conditions for extended periods may affect device reliability.

2.3 DC Characteristics

Electrical Characteristics: Extended (E): TAMB = -40°C to +125°C and High (H): TAMB = -40°C to +150°C; VDD = 4.5V to 5.5V, VIO = 1.8V to 5.5V (Note 2), RL = 60Ω, CL = 100 pF; unless otherwise specified.

Characteristic	Sym	Min	Typ	Max	Units	Conditions
SUPPLY						
VDD Pin						
Voltage Range	VDD	4.5	—	5.5		
Supply Current	IDD	—	5	10	mA	Recessive; VTXD = VDD
		—	45	70		Dominant; VTXD = 0V
Standby Current	IDDS	—	5	15	μA	MCP2561FD
		—	5	15		MCP2562FD ; Includes IIO
High Level of the POR Comparator	VPORH	3.8	—	4.3	V	
Low Level of the POR Comparator	VPORL	3.4	—	4.0	V	
Hysteresis of POR Comparator	VPORD	0.3	—	0.8	V	
VIO Pin						
Digital Supply Voltage Range	VIO	1.8	—	5.5	V	
Supply Current on VIO	IIO	—	4	30	μA	Recessive; VTXD = VIO
		—	85	500		Dominant; VTXD = 0V
Standby Current	IDDS	—	0.3	1	μA	(Note 1)
Undervoltage detection on VIO	VUVD(IO)	—	1.2	—	V	(Note 1)
BUS LINE (CANH; CANL) TRANSMITTER						
CANH; CANL: Recessive Bus Output Voltage	VO(R)	2.0	0.5VDD	3.0	V	VTXD = VDD; No load
CANH; CANL: Bus Output Voltage in Standby	VO(S)	-0.1	0.0	+0.1	V	STBY = VTXD = VDD; No load
Recessive Output Current	IO(R)	-5	—	+5	mA	-24V < VCAN < +24V
CANH: Dominant Output Voltage	VO(D)	2.75	3.50	4.50	V	TXD = 0; RL = 50 to 65Ω
CANL: Dominant Output Voltage		0.50	1.50	2.25		RL = 50 to 65Ω
Symmetry of Dominant Output Voltage (VDD – VCANH – VCANL)	VO(D)(M)	-400	0	+400	mV	VTXD = VSS (Note 1)
Dominant: Differential Output Voltage	VO(DIFF)	1.5	2.0	3.0	V	VTXD = VSS; RL = 50 to 65Ω Figure 2-2, Figure 2-4
Recessive: Differential Output Voltage		-120	0	12	mV	VTXD = VDD Figure 2-2, Figure 2-4
		-500	0	50	mV	VTXD = VDD no load. Figure 2-2, Figure 2-4

Note 1: Characterized; not 100% tested.

Note 2: Only MCP2562FD has VIO pin. For the MCP2561FD, VIO is internally connected to VDD.

Note 3: -12V to 12V is ensured by characterization, tested from -2V to 7V.

MCP2561/2FD

2.3 DC Characteristics (Continued)

Electrical Characteristics: Extended (E): T _{AMB} = -40°C to +125°C and High (H): T _{AMB} = -40°C to +150°C; V _{DD} = 4.5V to 5.5V, V _{IO} = 1.8V to 5.5V (Note 2), R _L = 60Ω, C _L = 100 pF; unless otherwise specified.						
Characteristic	Sym	Min	Typ	Max	Units	Conditions
CANH: Short Circuit Output Current	I _{O(SC)}	-120	85	—	mA	V _{TXD} = V _{SS} ; V _{CANH} = 0V; CANL: floating
		-100	—	—	mA	same as above, but V _{DD} =5V, T _{AMB} = 25°C (Note 1)
CANL: Short Circuit Output Current		—	75	+120	mA	V _{TXD} = V _{SS} ; V _{CANL} = 18V; CANH: floating
		—	—	+100	mA	same as above, but V _{DD} =5V, T _{AMB} = 25°C (Note 1)
BUS LINE (CANH; CANL) RECEIVER						
Recessive Differential Input Voltage	V _{DIFF(R)} (I)	-1.0	—	+0.5	V	Normal Mode; -12V < V(CANH, CANL) < +12V; See Figure 2-6 (Note 3)
		-1.0	—	+0.4		Standby Mode; -12V < V(CANH, CANL) < +12V; See Figure 2-6 (Note 3)
Dominant Differential Input Voltage	V _{DIFF(D)} (I)	0.9	—	V _{DD}	V	Normal Mode; -12V < V(CANH, CANL) < +12V; See Figure 2-6 (Note 3)
		1.0	—	V _{DD}		Standby Mode; -12V < V(CANH, CANL) < +12V; See Figure 2-6 (Note 3)
Differential Receiver Threshold	V _{TH} (DIFF)	0.5	0.7	0.9	V	Normal Mode; -12V < V(CANH, CANL) < +12V; See Figure 2-6 (Note 3)
		0.4	—	1.15		Standby Mode; -12V < V(CANH, CANL) < +12V; See Figure 2-6 (Note 3)
Differential Input Hysteresis	V _{HYS} (DIFF)	50	—	200	mV	Normal mode, see Figure 2-6, (Note 1)
Common Mode Input Resistance	R _{IN}	10	—	30	kΩ	(Note 1)
Common Mode Resistance Matching	R _{IN(M)}	-1	0	+1	%	V _{CANH} = V _{CANL} , (Note 1)
Differential Input Resistance	R _{IN} (DIFF)	10	—	100	kΩ	(Note 1)
Common Mode Input Capacitance	C _{IN} (CM)	—	—	20	pF	V _{TXD} = V _{DD} ; (Note 1)
Differential Input Capacitance	C _{IN} (DIFF)	—	—	10		V _{TXD} = V _{DD} ; (Note 1)
CANH, CANL: Input Leakage	I _{LI}	-5	—	+5	μA	V _{DD} = V _{TXD} = V _{STBY} = 0V. For MCP2562FD, V _{IO} = 0V. V _{CANH} = V _{CANL} = 5 V.

Note 1: Characterized; not 100% tested.

2: Only MCP2562FD has V_{IO} pin. For the MCP2561FD, V_{IO} is internally connected to V_{DD}.

3: -12V to 12V is ensured by characterization, tested from -2V to 7V.

2.3 DC Characteristics (Continued)

Electrical Characteristics: Extended (E): T _{AMB} = -40°C to +125°C and High (H): T _{AMB} = -40°C to +150°C; V _{DD} = 4.5V to 5.5V, V _{IO} = 1.8V to 5.5V (Note 2), R _L = 60Ω, C _L = 100 pF; unless otherwise specified.						
Characteristic	Sym	Min	Typ	Max	Units	Conditions
COMMON MODE STABILIZATION OUTPUT (SPLIT)						
Output Voltage	V _O	0.3V _{DD}	0.5V _{DD}	0.7V _{DD}	V	Normal mode; I _{SPLIT} = -500 μA to +500 μA
		0.45V _{DD}	0.5V _{DD}	0.55V _{DD}	V	Normal mode; R _L ≥ 1 MΩ
Leakage Current	I _L	-5	—	+5	μA	Standby mode; V _{SPLIT} = -24V to + 24V (ISO 11898: -12V ~ +12V)
DIGITAL INPUT PINS (TXD, STBY)						
High-Level Input Voltage	V _{IH}	0.7V _{IO}	—	V _{IO} + 0.3	V	
Low-Level Input Voltage	V _{IL}	-0.3	—	0.3V _{IO}	V	
High-Level Input Current	I _{IH}	-1	—	+1	μA	
TXD: Low-Level Input Current	I _{IL(TXD)}	-270	-150	-30	μA	
STBY: Low-Level Input Current	I _{IL(STBY)}	-30	—	-1	μA	
RECEIVE DATA (Rxd) OUTPUT						
High-Level Output Voltage	V _{OH}	V _{DD} - 0.4	—	—	V	I _{OH} = -2 mA (MCP2561FD); typical -4 mA
		V _{IO} - 0.4	—	—		I _{OH} = -1 mA (MCP2562FD); typical -2 mA
Low-Level Output Voltage	V _{OL}	—	—	0.4	V	I _{OL} = 4 mA; typical 8 mA
THERMAL SHUTDOWN						
Shutdown Junction Temperature	T _{J(SD)}	165	175	185	°C	-12V < V(CANH, CANL) < +12V, (Note 1)
Shutdown Temperature Hysteresis	T _{J(HYST)}	20	—	30	°C	-12V < V(CANH, CANL) < +12V, (Note 1)

Note 1: Characterized; not 100% tested.

2: Only MCP2562FD has V_{IO} pin. For the MCP2561FD, V_{IO} is internally connected to V_{DD}.

3: -12V to 12V is ensured by characterization, tested from -2V to 7V.

MCP2561/2FD

FIGURE 2-2: PHYSICAL BIT REPRESENTATION AND SIMPLIFIED BIAS IMPLEMENTATION

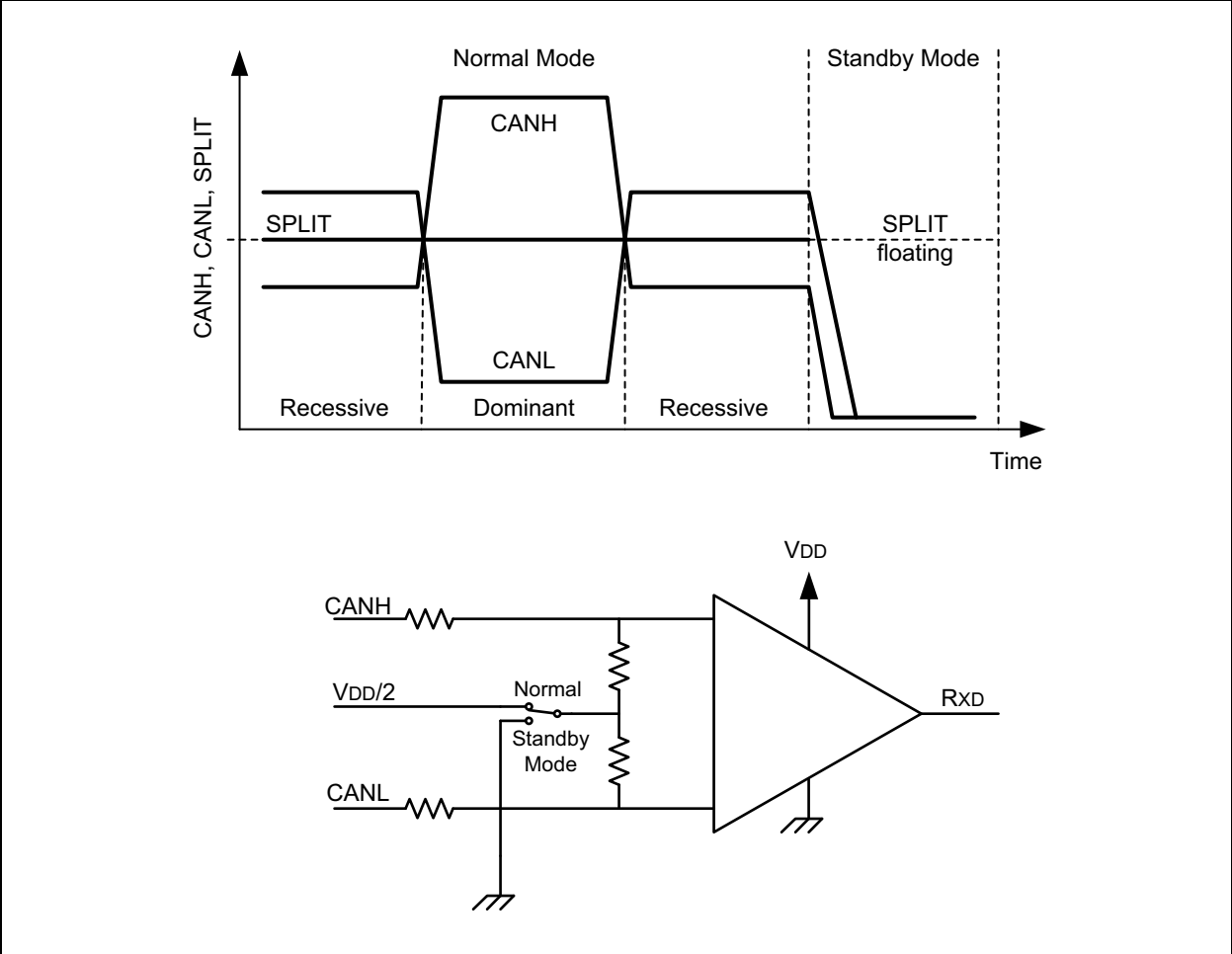

2.4 AC Characteristics

Electrical Characteristics: Extended (E): T_{AMB} = -40°C to +125°C and High (H): T_{AMB} = -40°C to +150°C; V_{DD} = 4.5V to 5.5V, V_{IO} = 1.8V to 5.5V (Note 2), R_L = 60Ω, C_L = 100 pF; unless otherwise specified.

Param. No.	Sym	Characteristic	Min	Typ	Max	Units	Conditions
1	t _{BIT}	Bit Time	0.2	—	69.44	μs	
2	f _{BIT}	Bit Frequency	14.4	—	5000	kHz	
3	t _{TXD-BUSON}	Delay TXD Low to Bus Dominant	—	65	—	ns	(Note 1)
4	t _{TXD-BUSOFF}	Delay TXD High to Bus Recessive	—	90	—	ns	(Note 1)
5	t _{BUSON-RXD}	Delay Bus Dominant to RxD	—	60	—	ns	(Note 1)
6	t _{BUSOFF-RXD}	Delay Bus Recessive to RxD	—	65	—	ns	(Note 1)
7	t _{TXD - RXD}	Propagation Delay TXD to RXD	—	90	120	ns	
			—	120	180	ns	R _L = 120Ω, C _L = 200 pF, (Note 1)
8a	t _{BIT(RXD),2M}	Recessive bit time on RxD - 2 Mbps, Loop Delay Symmetry	450	485	550	ns	t _{BIT(TXD)} = 500 ns, see Figure 2-10
			400	460	550	ns	t _{BIT(TXD)} = 500 ns, see Figure 2-10, R _L = 120Ω, C _L = 200 pF, (Note 1)
8b	t _{BIT(RXD),5M}	Recessive bit time on RxD - 5 Mbps, Loop Delay Symmetry	160	185	220	ns	t _{BIT(TXD)} = 200 ns, see Figure 2-10
8c	t _{BIT(RXD),8M}	Recessive bit time on RxD - 8 Mbps, Loop Delay Symmetry	85	105	140	ns	t _{BIT(TXD)} = 120 ns, see Figure 2-10 (Note 1)
9	t _{FLTR(WAKE)}	Delay Bus Dominant to RxD (Standby mode)	0.5	1	4	μs	Standby mode
10	t _{WAKE}	Delay Standby to Normal Mode	5	25	40	μs	Negative edge on STBY
11	t _{PDT}	Permanent Dominant Detect Time	—	1.25	—	ms	TXD = 0V
12	t _{PDTR}	Permanent Dominant Timer Reset	—	100	—	ns	The shortest Recessive pulse on TXD or CAN bus to reset Permanent Dominant Timer

Note 1: Characterized, not 100% tested.

FIGURE 2-3: TEST LOAD CONDITIONS



MCP2561/2FD

FIGURE 2-4: TEST CIRCUIT FOR ELECTRICAL CHARACTERISTICS



FIGURE 2-5: TEST CIRCUIT FOR AUTOMOTIVE TRANSIENTS



FIGURE 2-6: HYSTERESIS OF THE RECEIVER



2.5 Timing Diagrams and Specifications

FIGURE 2-7: TIMING DIAGRAM FOR AC CHARACTERISTICS

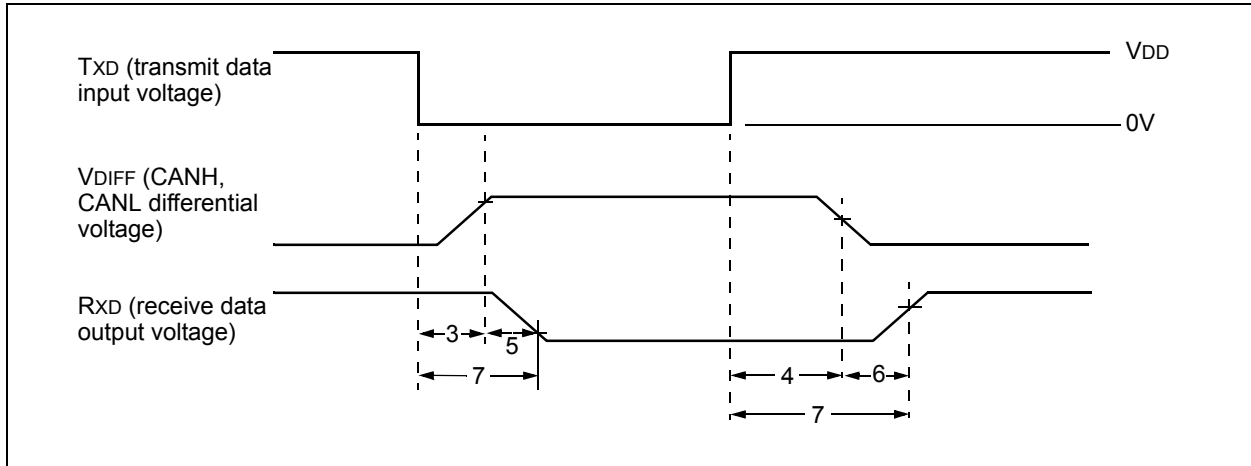

FIGURE 2-8: TIMING DIAGRAM FOR WAKEUP FROM STANDBY

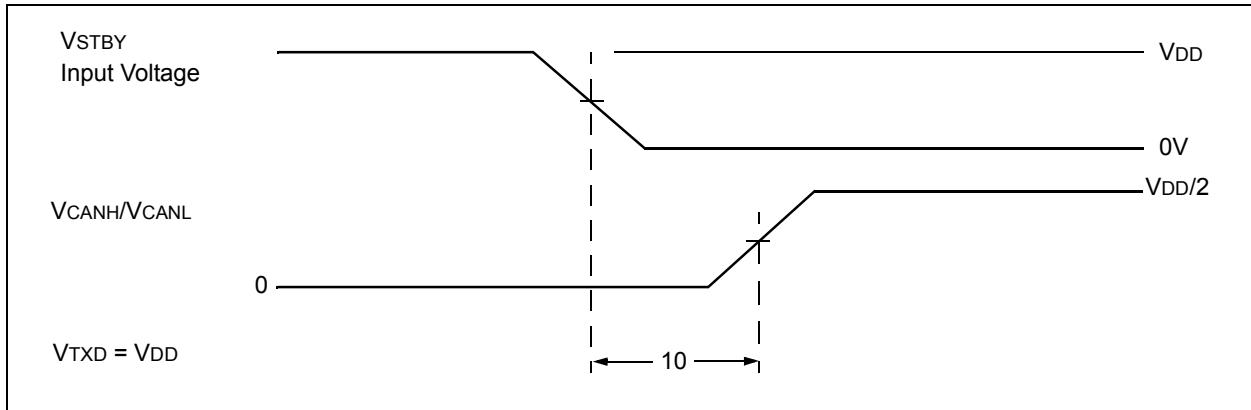
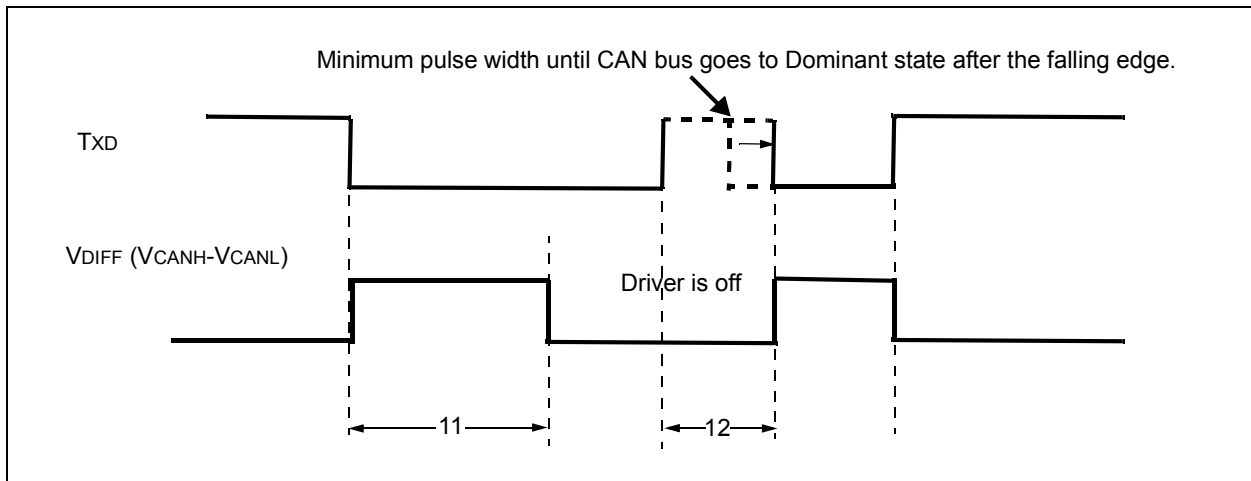

FIGURE 2-9: PERMANENT DOMINANT TIMER RESET DETECT



MCP2561/2FD

FIGURE 2-10: TIMING DIAGRAM FOR LOOP DELAY SYMMETRY



2.6 Thermal Specifications

Parameter	Symbol	Min	Typ	Max	Units	Test Conditions
Temperature Ranges						
Specified Temperature Range	TA	-40	—	+125	°C	
		-40	—	+150		
Operating Temperature Range	TA	-40	—	+150	°C	
Storage Temperature Range	TA	-65	—	+155	°C	
Thermal Package Resistances						
Thermal Resistance, 8L-DFN 3x3	θ_{JA}	—	56.7	—	°C/W	
Thermal Resistance, 8L-PDIP	θ_{JA}	—	89.3	—	°C/W	
Thermal Resistance, 8L-SOIC	θ_{JA}	—	149.5	—	°C/W	

3.0 PACKAGING INFORMATION

3.1 Package Marking Information

8-Lead DFN (3x3 mm)



Part Number	Code
MCP2561FD-E/MF	DADY
MCP2561FDT-E/MF	DADY
MCP2561FD-H/MF	DADZ
MCP2561FDT-H/MF	DADZ
MCP2562FD-E/MF	DAEA
MCP2562FDT-E/MF	DAEA
MCP2562FD-H/MF	DAEB
MCP2562FDT-H/MF	DAEB

Example:



8-Lead PDIP (300 mil)

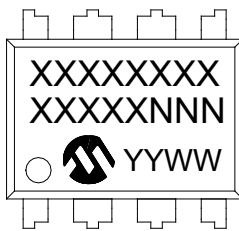

Example:



OR



8-Lead SOIC (150 mil)



Example:



OR

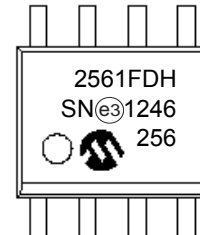

Legend:	XX...X	Customer-specific information
	Y	Year code (last digit of calendar year)
	YY	Year code (last 2 digits of calendar year)
	WW	Week code (week of January 1 is week '01')
	NNN	Alphanumeric traceability code
	(e3)	Pb-free JEDEC designator for Matte Tin (Sn)
	*	This package is Pb-free. The Pb-free JEDEC designator (e3) can be found on the outer packaging for this package.

Note: In the event the full Microchip part number cannot be marked on one line, it will be carried over to the next line, thus limiting the number of available characters for customer-specific information.

MCP2561/2FD

8-Lead Plastic Dual Flat, No Lead Package (MF) - 3x3x0.9mm Body [DFN]

Note: For the most current package drawings, please see the Microchip Packaging Specification located at <http://www.microchip.com/packaging>



Microchip Technology Drawing No. C04-062C Sheet 1 of 2

8-Lead Plastic Dual Flat, No Lead Package (MF) - 3x3x0.9mm Body [DFN]

Note: For the most current package drawings, please see the Microchip Packaging Specification located at <http://www.microchip.com/packaging>



Dimension Limits	Units	MILLIMETERS		
		MIN	NOM	MAX
Number of Pins	N	8		
Pitch	e	0.65 BSC		
Overall Height	A	0.80	0.90	1.00
Standoff	A1	0.00	0.02	0.05
Contact Thickness	A3	0.20 REF		
Overall Length	D	3.00 BSC		
Exposed Pad Width	E2	1.34	-	1.60
Overall Width	E	3.00 BSC		
Exposed Pad Length	D2	1.60	-	2.40
Contact Width	b	0.25	0.30	0.35
Contact Length	L	0.20	0.30	0.55
Contact-to-Exposed Pad	K	0.20	-	-

Notes:

1. Pin 1 visual index feature may vary, but must be located within the hatched area.
2. Package may have one or more exposed tie bars at ends.
3. Package is saw singulated
4. Dimensioning and tolerancing per ASME Y14.5M
 - BSC: Basic Dimension. Theoretically exact value shown without tolerances.
 - REF: Reference Dimension, usually without tolerance, for information purposes only.

Microchip Technology Drawing No. C04-062C Sheet 2 of 2

MCP2561/2FD

8-Lead Plastic Dual Flat, No Lead Package (MF) - 3x3x0.9mm Body [DFN]

Note: For the most current package drawings, please see the Microchip Packaging Specification located at <http://www.microchip.com/packaging>



RECOMMENDED LAND PATTERN

Dimension Limits	Units	MILLIMETERS		
		MIN	NOM	MAX
Contact Pitch	E	0.65 BSC		
Optional Center Pad Width	W2			2.40
Optional Center Pad Length	T2			1.55
Contact Pad Spacing	C1		3.10	
Contact Pad Width (X8)	X1			0.35
Contact Pad Length (X8)	Y1			0.65
Distance Between Pads	G	0.30		

Notes:

1. Dimensioning and tolerancing per ASME Y14.5M

BSC: Basic Dimension. Theoretically exact value shown without tolerances.

Microchip Technology Drawing No. C04-2062B

MCP2561/2FD

8-Lead Plastic Dual In-Line (P) - 300 mil Body [PDIP]

Note: For the most current package drawings, please see the Microchip Packaging Specification located at <http://www.microchip.com/packaging>



Microchip Technology Drawing No. C04-018D Sheet 1 of 2

MCP2561/2FD

8-Lead Plastic Dual In-Line (P) - 300 mil Body [PDIP]

Note: For the most current package drawings, please see the Microchip Packaging Specification located at <http://www.microchip.com/packaging>

ALTERNATE LEAD DESIGN (VENDOR DEPENDENT)



Dimension Limits	Units	INCHES		
		MIN	NOM	MAX
Number of Pins	N	8		
Pitch	e	.100 BSC		
Top to Seating Plane	A	-	-	.210
Molded Package Thickness	A2	.115	.130	.195
Base to Seating Plane	A1	.015	-	-
Shoulder to Shoulder Width	E	.290	.310	.325
Molded Package Width	E1	.240	.250	.280
Overall Length	D	.348	.365	.400
Tip to Seating Plane	L	.115	.130	.150
Lead Thickness	c	.008	.010	.015
Upper Lead Width	b1	.040	.060	.070
Lower Lead Width	b	.014	.018	.022
Overall Row Spacing	§	eB	-	.430

Notes:

1. Pin 1 visual index feature may vary, but must be located within the hatched area.
2. § Significant Characteristic
3. Dimensions D and E1 do not include mold flash or protrusions. Mold flash or protrusions shall not exceed .010" per side.
4. Dimensioning and tolerancing per ASME Y14.5M

BSC: Basic Dimension. Theoretically exact value shown without tolerances.

Microchip Technology Drawing No. C04-018D Sheet 2 of 2

8-Lead Plastic Small Outline (SN) - Narrow, 3.90 mm Body [SOIC]

Note: For the most current package drawings, please see the Microchip Packaging Specification located at <http://www.microchip.com/packaging>



Microchip Technology Drawing No. C04-057C Sheet 1 of 2

MCP2561/2FD

8-Lead Plastic Small Outline (SN) - Narrow, 3.90 mm Body [SOIC]

Note: For the most current package drawings, please see the Microchip Packaging Specification located at <http://www.microchip.com/packaging>



Dimension Limits	Units	MILLIMETERS		
		MIN	NOM	MAX
Number of Pins	N	8		
Pitch	e	1.27 BSC		
Overall Height	A	-	-	1.75
Molded Package Thickness	A2	1.25	-	-
Standoff §	A1	0.10	-	0.25
Overall Width	E	6.00 BSC		
Molded Package Width	E1	3.90 BSC		
Overall Length	D	4.90 BSC		
Chamfer (Optional)	h	0.25	-	0.50
Foot Length	L	0.40	-	1.27
Footprint	L1	1.04 REF		
Foot Angle	φ	0°	-	8°
Lead Thickness	c	0.17	-	0.25
Lead Width	b	0.31	-	0.51
Mold Draft Angle Top	α	5°	-	15°
Mold Draft Angle Bottom	β	5°	-	15°

Notes:

1. Pin 1 visual index feature may vary, but must be located within the hatched area.
2. § Significant Characteristic
3. Dimensions D and E1 do not include mold flash or protrusions. Mold flash or protrusions shall not exceed 0.15mm per side.
4. Dimensioning and tolerancing per ASME Y14.5M

BSC: Basic Dimension. Theoretically exact value shown without tolerances.

REF: Reference Dimension, usually without tolerance, for information purposes only.

Microchip Technology Drawing No. C04-057C Sheet 2 of 2

8-Lead Plastic Small Outline (SN) – Narrow, 3.90 mm Body [SOIC]

Note: For the most current package drawings, please see the Microchip Packaging Specification located at <http://www.microchip.com/packaging>

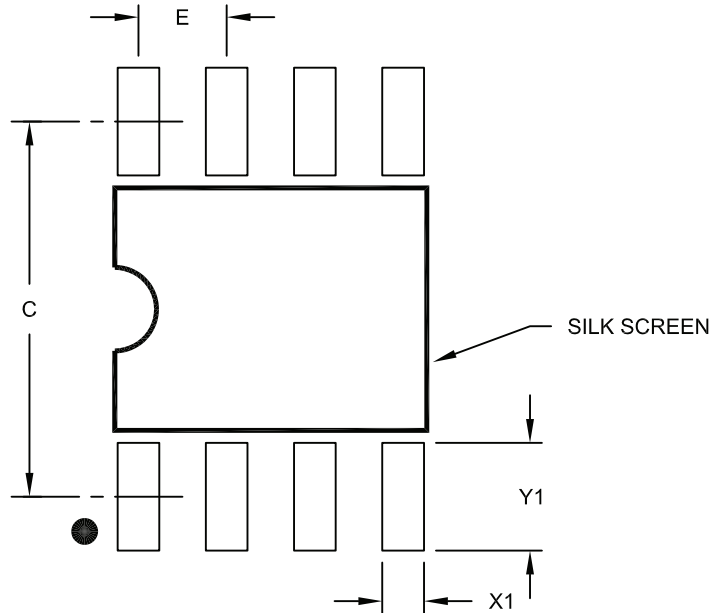

RECOMMENDED LAND PATTERN

Dimension Limits	Units	MILLIMETERS		
		MIN	NOM	MAX
Contact Pitch	E	1.27 BSC		
Contact Pad Spacing	C		5.40	
Contact Pad Width (X8)	X1			0.60
Contact Pad Length (X8)	Y1			1.55

Notes:

1. Dimensioning and tolerancing per ASME Y14.5M

BSC: Basic Dimension. Theoretically exact value shown without tolerances.

Microchip Technology Drawing No. C04-2057A

MCP2561/2FD

NOTES:

APPENDIX A: REVISION HISTORY

Revision A (March 2014)

Original Release of this Document.

MCP2561/2FD

NOTES:

PRODUCT IDENTIFICATION SYSTEM

To order or obtain information, e.g., on pricing or delivery, contact the factory or one of the sales offices listed on the back page.

<u>PART NO.</u>	<u>-X</u>	<u>/XX</u>
Device	Temperature Range	Package
<p>Device:</p> <p>MCP2561FD:High-Speed CAN Transceiver with SPLIT MCP2561FDT:High-Speed CAN Transceiver with SPLIT (Tape and Reel) (DFN and SOIC only) MCP2562FD:High-Speed CAN Transceiver with Vio MCP2562FDT:High-Speed CAN Transceiver with Vio (Tape and Reel) (DFN and SOIC only)</p> <p>Temperature Range:</p> <p>E = -40°C to +125°C (Extended) H = -40°C to +150°C (High)</p> <p>Package:</p> <p>MF = Plastic Dual Flat, No Lead Package - 3x3x0.9 mm Body, 8-lead P = Plastic Dual In-Line - 300 mil Body, 8-lead SN = Plastic Small Outline - Narrow, 3.90 mm Body, 8-lead</p>		<p>Examples:</p> <p>a) MCP2561FD-E/MF:Extended Temperature, 8LD 3x3 DFN package.</p> <p>b) MCP2561FDT-E/MF:Tape and Reel, Extended Temperature, 8LD 3x3 DFN package.</p> <p>c) MCP2561FD-E/P: Extended Temperature, 8LD PDIP package.</p> <p>d) MCP2561FD-E/SN:Extended Temperature, 8LD SOIC package.</p> <p>e) MCP2561FDT-E/SN:Tape and Reel, Extended Temperature, 8LD SOIC package.</p> <p>a) MCP2561FD-H/MF:High Temperature, 8LD 3x3 DFN package.</p> <p>b) MCP2561FDT-H/MF:Tape and Reel, High Temperature, 8LD 3x3 DFN package.</p> <p>c) MCP2561FD-H/P: High Temperature, 8LD PDIP package.</p> <p>d) MCP2561FD-H/SN:High Temperature, 8LD SOIC package.</p> <p>e) MCP2561FDT-H/SN:Tape and Reel, High Temperature, 8LD SOIC package.</p>

MCP2561/2FD

NOTES:

Note the following details of the code protection feature on Microchip devices:

- Microchip products meet the specification contained in their particular Microchip Data Sheet.
- Microchip believes that its family of products is one of the most secure families of its kind on the market today, when used in the intended manner and under normal conditions.
- There are dishonest and possibly illegal methods used to breach the code protection feature. All of these methods, to our knowledge, require using the Microchip products in a manner outside the operating specifications contained in Microchip's Data Sheets. Most likely, the person doing so is engaged in theft of intellectual property.
- Microchip is willing to work with the customer who is concerned about the integrity of their code.
- Neither Microchip nor any other semiconductor manufacturer can guarantee the security of their code. Code protection does not mean that we are guaranteeing the product as “unbreakable.”

Code protection is constantly evolving. We at Microchip are committed to continuously improving the code protection features of our products. Attempts to break Microchip's code protection feature may be a violation of the Digital Millennium Copyright Act. If such acts allow unauthorized access to your software or other copyrighted work, you may have a right to sue for relief under that Act.

Information contained in this publication regarding device applications and the like is provided only for your convenience and may be superseded by updates. It is your responsibility to ensure that your application meets with your specifications. MICROCHIP MAKES NO REPRESENTATIONS OR WARRANTIES OF ANY KIND WHETHER EXPRESS OR IMPLIED, WRITTEN OR ORAL, STATUTORY OR OTHERWISE, RELATED TO THE INFORMATION, INCLUDING BUT NOT LIMITED TO ITS CONDITION, QUALITY, PERFORMANCE, MERCHANTABILITY OR FITNESS FOR PURPOSE. Microchip disclaims all liability arising from this information and its use. Use of Microchip devices in life support and/or safety applications is entirely at the buyer's risk, and the buyer agrees to defend, indemnify and hold harmless Microchip from any and all damages, claims, suits, or expenses resulting from such use. No licenses are conveyed, implicitly or otherwise, under any Microchip intellectual property rights.

Trademarks

The Microchip name and logo, the Microchip logo, dsPIC, FlashFlex, KEELOQ, KEELOQ logo, MPLAB, PIC, PICmicro, PICSTART, PIC³² logo, rPIC, SST, SST Logo, SuperFlash and UNI/O are registered trademarks of Microchip Technology Incorporated in the U.S.A. and other countries.

FilterLab, Hampshire, HI-TECH C, Linear Active Thermistor, MTP, SEEVAL and The Embedded Control Solutions Company are registered trademarks of Microchip Technology Incorporated in the U.S.A.

Silicon Storage Technology is a registered trademark of Microchip Technology Inc. in other countries.

Analog-for-the-Digital Age, Application Maestro, BodyCom, chipKIT, chipKIT logo, CodeGuard, dsPICDEM, dsPICDEM.net, dsPICworks, dsSPEAK, ECAN, ECONOMONITOR, FanSense, HI-TIDE, In-Circuit Serial Programming, ICSP, Mindi, MiWi, MPASM, MPF, MPLAB Certified logo, MPLIB, MPLINK, mTouch, Omniclient Code Generation, PICC, PICC-18, PICDEM, PICDEM.net, PICkit, PICtail, REAL ICE, rLAB, Select Mode, SQI, Serial Quad I/O, Total Endurance, TSHARC, UniWinDriver, WiperLock, ZENA and Z-Scale are trademarks of Microchip Technology Incorporated in the U.S.A. and other countries.

SQTP is a service mark of Microchip Technology Incorporated in the U.S.A.

GestIC and ULPP are registered trademarks of Microchip Technology Germany II GmbH & Co. KG, a subsidiary of Microchip Technology Inc., in other countries.

All other trademarks mentioned herein are property of their respective companies.

© 2014, Microchip Technology Incorporated, Printed in the U.S.A., All Rights Reserved.

 Printed on recycled paper.

ISBN: 978-1-63276-020-3

QUALITY MANAGEMENT SYSTEM
CERTIFIED BY DNV
== ISO/TS 16949 ==

Microchip received ISO/TS-16949:2009 certification for its worldwide headquarters, design and wafer fabrication facilities in Chandler and Tempe, Arizona; Gresham, Oregon and design centers in California and India. The Company's quality system processes and procedures are for its PIC[®] MCUs and dsPIC[®] DSCs, KEELOQ[®] code hopping devices, Serial EEPROMs, microperipherals, nonvolatile memory and analog products. In addition, Microchip's quality system for the design and manufacture of development systems is ISO 9001:2000 certified.



MICROCHIP

Worldwide Sales and Service

AMERICAS

Corporate Office
2355 West Chandler Blvd.
Chandler, AZ 85224-6199
Tel: 480-792-7200
Fax: 480-792-7277
Technical Support:
<http://www.microchip.com/support>
Web Address:
www.microchip.com

Atlanta
Duluth, GA
Tel: 678-957-9614
Fax: 678-957-1455

Austin, TX
Tel: 512-257-3370

Boston
Westborough, MA
Tel: 774-760-0087
Fax: 774-760-0088

Chicago
Itasca, IL
Tel: 630-285-0071
Fax: 630-285-0075

Cleveland
Independence, OH
Tel: 216-447-0464
Fax: 216-447-0643

Dallas
Addison, TX
Tel: 972-818-7423
Fax: 972-818-2924

Detroit
Novi, MI
Tel: 248-848-4000

Houston, TX
Tel: 281-894-5983

Indianapolis
Noblesville, IN
Tel: 317-773-8323
Fax: 317-773-5453

Los Angeles
Mission Viejo, CA
Tel: 949-462-9523
Fax: 949-462-9608

New York, NY
Tel: 631-435-6000

San Jose, CA
Tel: 408-735-9110

Canada - Toronto
Tel: 905-673-0699
Fax: 905-673-6509

ASIA/PACIFIC

Asia Pacific Office
Suites 3707-14, 37th Floor
Tower 6, The Gateway
Harbour City, Kowloon
Hong Kong
Tel: 852-2943-5100
Fax: 852-2401-3431

Australia - Sydney
Tel: 61-2-9868-6733
Fax: 61-2-9868-6755

China - Beijing
Tel: 86-10-8569-7000
Fax: 86-10-8528-2104

China - Chengdu
Tel: 86-28-8665-5511
Fax: 86-28-8665-7889

China - Chongqing
Tel: 86-23-8980-9588
Fax: 86-23-8980-9500

China - Hangzhou
Tel: 86-571-8792-8115
Fax: 86-571-8792-8116

China - Hong Kong SAR
Tel: 852-2943-5100
Fax: 852-2401-3431

China - Nanjing
Tel: 86-25-8473-2460
Fax: 86-25-8473-2470

China - Qingdao
Tel: 86-532-8502-7355
Fax: 86-532-8502-7205

China - Shanghai
Tel: 86-21-5407-5533
Fax: 86-21-5407-5066

China - Shenyang
Tel: 86-24-2334-2829
Fax: 86-24-2334-2393

China - Shenzhen
Tel: 86-755-8864-2200
Fax: 86-755-8203-1760

China - Wuhan
Tel: 86-27-5980-5300
Fax: 86-27-5980-5118

China - Xian
Tel: 86-29-8833-7252
Fax: 86-29-8833-7256

China - Xiamen
Tel: 86-592-2388138
Fax: 86-592-2388130

China - Zhuhai
Tel: 86-756-3210040
Fax: 86-756-3210049

ASIA/PACIFIC

India - Bangalore
Tel: 91-80-3090-4444
Fax: 91-80-3090-4123

India - New Delhi
Tel: 91-11-4160-8631
Fax: 91-11-4160-8632

India - Pune
Tel: 91-20-3019-1500

Japan - Osaka
Tel: 81-6-6152-7160
Fax: 81-6-6152-9310

Japan - Tokyo
Tel: 81-3-6880-3770
Fax: 81-3-6880-3771

Korea - Daegu
Tel: 82-53-744-4301
Fax: 82-53-744-4302

Korea - Seoul
Tel: 82-2-554-7200
Fax: 82-2-558-5932 or
82-2-558-5934

Malaysia - Kuala Lumpur
Tel: 60-3-6201-9857
Fax: 60-3-6201-9859

Malaysia - Penang
Tel: 60-4-227-8870
Fax: 60-4-227-4068

Philippines - Manila
Tel: 63-2-634-9065
Fax: 63-2-634-9069

Singapore
Tel: 65-6334-8870
Fax: 65-6334-8850

Taiwan - Hsin Chu
Tel: 886-3-5778-366
Fax: 886-3-5770-955

Taiwan - Kaohsiung
Tel: 886-7-213-7830

Taiwan - Taipei
Tel: 886-2-2508-8600
Fax: 886-2-2508-0102

Thailand - Bangkok
Tel: 66-2-694-1351
Fax: 66-2-694-1350

EUROPE

Austria - Wels
Tel: 43-7242-2244-39
Fax: 43-7242-2244-393

Denmark - Copenhagen
Tel: 45-4450-2828
Fax: 45-4485-2829

France - Paris
Tel: 33-1-69-53-63-20
Fax: 33-1-69-30-90-79

Germany - Dusseldorf
Tel: 49-2129-3766400

Germany - Munich
Tel: 49-89-627-144-0
Fax: 49-89-627-144-44

Germany - Pforzheim
Tel: 49-7231-424750

Italy - Milan
Tel: 39-0331-742611
Fax: 39-0331-466781

Italy - Venice
Tel: 39-049-7625286

Netherlands - Drunen
Tel: 31-416-690399
Fax: 31-416-690340

Poland - Warsaw
Tel: 48-22-3325737

Spain - Madrid
Tel: 34-91-708-08-90
Fax: 34-91-708-08-91

Sweden - Stockholm
Tel: 46-8-5090-4654

UK - Wokingham
Tel: 44-118-921-5800
Fax: 44-118-921-5820

03/25/14

Компания «Океан Электроники» предлагает заключение долгосрочных отношений при поставках импортных электронных компонентов на взаимовыгодных условиях!

Наши преимущества:

- Поставка оригинальных импортных электронных компонентов напрямую с производств Америки, Европы и Азии, а так же с крупнейших складов мира;
- Широкая линейка поставок активных и пассивных импортных электронных компонентов (более 30 млн. наименований);
- Поставка сложных, дефицитных, либо снятых с производства позиций;
- Оперативные сроки поставки под заказ (от 5 рабочих дней);
- Экспресс доставка в любую точку России;
- Помощь Конструкторского Отдела и консультации квалифицированных инженеров;
- Техническая поддержка проекта, помощь в подборе аналогов, поставка прототипов;
- Поставка электронных компонентов под контролем ВП;
- Система менеджмента качества сертифицирована по Международному стандарту ISO 9001;
- При необходимости вся продукция военного и аэрокосмического назначения проходит испытания и сертификацию в лаборатории (по согласованию с заказчиком);
- Поставка специализированных компонентов военного и аэрокосмического уровня качества (Xilinx, Altera, Analog Devices, Intersil, Interpoint, Microsemi, Actel, Aeroflex, Peregrine, VPT, Syfer, Eurofarad, Texas Instruments, MS Kennedy, Miteq, Cobham, E2V, MA-COM, Hittite, Mini-Circuits, General Dynamics и др.);

Компания «Океан Электроники» является официальным дистрибьютором и эксклюзивным представителем в России одного из крупнейших производителей разъемов военного и аэрокосмического назначения «JONHON», а так же официальным дистрибьютором и эксклюзивным представителем в России производителя высокотехнологичных и надежных решений для передачи СВЧ сигналов «FORSTAR».



JONHON

«JONHON» (основан в 1970 г.)

Разъемы специального, военного и аэрокосмического назначения:

(Применяются в военной, авиационной, аэрокосмической, морской, железнодорожной, горно- и нефтедобывающей отраслях промышленности)

«FORSTAR» (основан в 1998 г.)

ВЧ соединители, коаксиальные кабели, кабельные сборки и микроволновые компоненты:

(Применяются в телекоммуникациях гражданского и специального назначения, в средствах связи, РЛС, а так же военной, авиационной и аэрокосмической отраслях промышленности).



Телефон: 8 (812) 309-75-97 (многоканальный)

Факс: 8 (812) 320-03-32

Электронная почта: ocean@oceanchips.ru

Web: <http://oceanchips.ru/>

Адрес: 198099, г. Санкт-Петербург, ул. Калинина, д. 2, корп. 4, лит. А