

FEATURES

- **Wide Input Supply Range:**
 4.7V to 22V – 4.2 Version
 8.9V to 22V – 8.4 Version
- **High Efficiency Current Mode PWM Controller with 500kHz Switching Frequency**
- **±1% Charge Voltage Accuracy**
- **End-of-Charge Current Detection Output**
- **3 Hour Charge Termination Timer**
- Constant Switching Frequency for Minimum Noise
- ±5% Charge Current Accuracy
- Low 10 μ A Reverse Battery Drain Current
- Automatic Battery Recharge
- Automatic Shutdown When Input Supply is Removed
- Automatic Trickle Charging of Low Voltage Batteries
- Battery Temperature Sensing and Charge Qualification
- Stable with Ceramic Output Capacitor
- 8-Lead SO and 10-Lead DFN Packages

APPLICATIONS

- Portable Computers
- Charging Docks
- Handheld Instruments

DESCRIPTION

The LTC[®]4002 is a complete battery charger controller for one (4.2V) or two (8.4V) cell lithium-ion batteries. With a 500kHz switching frequency, the LTC4002 provides a small, simple and efficient solution to fast charge Li-Ion batteries from a wide range of supply voltages. An external sense resistor sets the charge current with $\pm 5\%$ accuracy. An internal resistor divider and precision reference set the final float voltage to 4.2V per cell with $\pm 1\%$ accuracy.

When the input supply is removed, the LTC4002 automatically enters a low current sleep mode, dropping the battery drain current to 10 μ A. An internal comparator detects the near end-of-charge condition while an internal timer sets the total charge time and terminates the charge cycle. After the charge cycle ends, if the battery voltage drops below 4.05V per cell, a new charge cycle will automatically begin.

The LTC4002 is available in the 8-lead SO and 10-lead DFN packages.

LT, LTC and LT are registered trademarks of Linear Technology Corporation. All other trademarks are the property of their respective owners.

TYPICAL APPLICATION

1.5A Single Cell Li-Ion Battery Charger

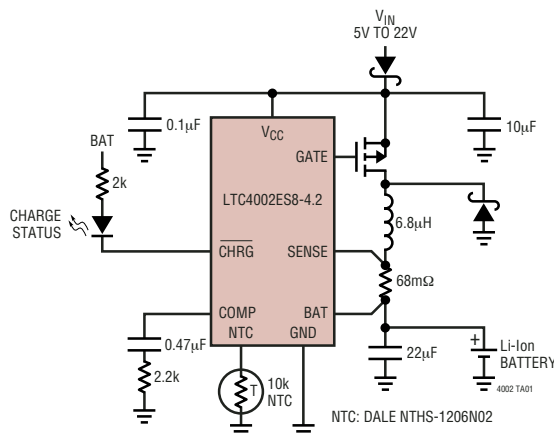

Efficiency vs Input Voltage

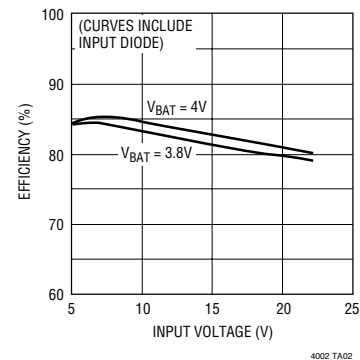

LTC4002

ABSOLUTE MAXIMUM RATINGS (Note 1)

Supply Voltage (V_{CC})	24V	Operating Temperature Range (Note 4) ..	-40°C to 85°C
GATE	($V_{CC} - 8V$) to V_{CC}	Storage Temperature Range	-65°C to 125°C
BAT, SENSE	-0.3V to 14V	Lead Temperature (S8 Package)	
CHRG, NTC	-0.3V to 8V	(Soldering, 10 sec)	300°C

PACKAGE/ORDER INFORMATION

<p>DD PACKAGE 10-LEAD (3mm x 3mm) PLASTIC DFN $T_{JMAX} = 125^{\circ}C$, $\theta_{JA} = 43^{\circ}C/W$ EXPOSED PAD IS GND (PIN 11) MUST BE SOLDERED TO PCB</p>	ORDER PART NUMBER	<p>S8 PACKAGE 8-LEAD PLASTIC SO $T_{JMAX} = 125^{\circ}C$, $\theta_{JA} = 110^{\circ}C/W$</p>	ORDER PART NUMBER
	LTC4002EDD-4.2 LTC4002EDD-8.4		LTC4002ES8-4.2 LTC4002ES8-8.4
	DD PART MARKING		S8 PART MARKING
	LAGG LBGY		400242 400284

Consult LTC Marketing for parts specified with wider operating temperature ranges.

ELECTRICAL CHARACTERISTICS (LTC4002-4.2) The ● denotes the specifications which apply over the full operating temperature range, otherwise specifications are at $T_A = 25^{\circ}C$. $V_{CC} = 10V$ unless otherwise noted.

SYMBOL	PARAMETER	CONDITIONS	MIN	TYP	MAX	UNITS	
V_{CC}	V_{CC} Supply Voltage		● 4.7		22	V	
I_{CC}	V_{CC} Supply Current	Current Mode		3	5	mA	
		Shutdown Mode		3	5	mA	
		Sleep Mode		10	20	μA	
$V_{BAT(FLT)}$	Battery Regulated Float Voltage	$5V \leq V_{CC} \leq 22V$ (Note 2)	● 4.168	4.2	4.232	V	
			● 4.158		4.242	V	
$V_{SNS(CHG)}$	Constant Current Sense Voltage	$3V \leq V_{BAT} \leq 4V$ (Note 3) $0^{\circ}C \leq T_A \leq 85^{\circ}C$ $-40^{\circ}C \leq T_A \leq 85^{\circ}C$	● 93	100	107	mV	
			● 90		110	mV	
$V_{SNS(TRKL)}$	Trickle Current Sense Voltage	$V_{BAT} = 0V$ (Note 3)		5	10	15	mV
V_{TRKL}	Trickle Charge Threshold Voltage	V_{BAT} Rising		2.75	2.9	3.05	V
V_{UV}	V_{CC} Undervoltage Lockout Threshold Voltage	V_{CC} Rising		3.9	4.2	4.5	V
ΔV_{UV}	V_{CC} Undervoltage Lockout Hysteresis Voltage			200		mV	
V_{MSD}	Manual Shutdown Threshold Voltage	COMP Pin Falling		200	360	500	mV
V_{ASD}	Automatic Shutdown Threshold Voltage	$V_{CC} - V_{BAT}$		250		mV	
I_{COMP}	COMP Pin Output Current	$V_{COMP} = 1.2V$		100		μA	
I_{CHRG}	CHRG Pin Weak Pull-Down Current	$V_{CHRG} = 1V$		15	25	35	μA
V_{CHRG}	CHRG Pin Output Low Voltage	$I_{CHRG} = 1mA$		0.15	0.3	V	
R_{EOC}	End-of-Charge Ratio	$V_{SNS(EOC)} / V_{SNS(CHG)}$		10	25	32	%
t_{TIMER}	Charge Time Accuracy				10	%	

4002f

ELECTRICAL CHARACTERISTICS (LTC4002-4.2) The ● denotes the specifications which apply over the full operating temperature range, otherwise specifications are at $T_A = 25^\circ\text{C}$. $V_{CC} = 10\text{V}$ unless otherwise noted.

SYMBOL	PARAMETER	CONDITIONS	MIN	TYP	MAX	UNITS
I_{NTC}	NTC Pin Output Current	$V_{\text{NTC}} = 0.85\text{V}$	● 75	85	95	μA
$V_{\text{NTC-HOT}}$	NTC Pin Threshold Voltage (Hot)	V_{NTC} Falling Hysteresis	● 340	355 25	370	mV mV
$V_{\text{NTC-COLD}}$	NTC Pin Threshold Voltage (Cold)	V_{NTC} Rising Hysteresis	● 2.428	2.465 170	2.502	V mV
ΔV_{RECHRG}	Recharge Battery Voltage Offset from Full Charged Battery Voltage	$V_{\text{BAT(FULLCHARGED)}} - V_{\text{RECHRG}}$, V_{BAT} Falling	100	150	200	mV
I_{LEAK}	CHRG Pin Leakage Current	$V_{\text{CHRG}} = 8\text{V}$, Charging Stops			1	μA

Oscillator

f_{OSC}	Switching Frequency		450	500	550	kHz
DC	Maximum Duty Cycle				100	%

Gate Drive

t_r	Rise Time	$C_{\text{GATE}} = 2000\text{pF}$, 10% to 90%		20		ns
t_f	Fall Time	$C_{\text{GATE}} = 2000\text{pF}$, 90% to 10%		50		ns
ΔV_{GATE}	Output Clamp Voltage	$V_{\text{CC}} - V_{\text{GATE}}$, $V_{\text{CC}} \geq 9\text{V}$	●		8	V
ΔV_{GATEHI}	Output High Voltage	$\Delta V_{\text{GATEHI}} = V_{\text{CC}} - V_{\text{GATE}}$, $V_{\text{CC}} \geq 7\text{V}$	●		0.3	V
ΔV_{GATELO}	Output Low Voltage	$\Delta V_{\text{GATELO}} = V_{\text{CC}} - V_{\text{GATE}}$, $V_{\text{CC}} \geq 7\text{V}$	●	4.5		V

(LTC4002-8.4) The ● denotes the specifications which apply over the full operating temperature range, otherwise specifications are at $T_A = 25^\circ\text{C}$. $V_{CC} = 12\text{V}$ unless otherwise noted.

SYMBOL	PARAMETER	CONDITIONS	MIN	TYP	MAX	UNITS	
DC Characteristics							
V_{CC}	V_{CC} Supply Voltage		● 8.9		22	V	
I_{CC}	V_{CC} Supply Current	Current Mode Shutdown Mode Sleep Mode		3 3 10	5 5 20	mA mA μA	
$V_{\text{BAT(FLT)}}$	Battery Regulated Float Voltage	$9\text{V} \leq V_{\text{CC}} \leq 22\text{V}$ (Note 2)	● 8.336 8.316	8.4	8.464 8.484	V V	
$V_{\text{SNS(CHG)}}$	Constant Current Sense Voltage	$6\text{V} \leq V_{\text{BAT}} \leq 8\text{V}$ (Note 3)	● 95 93	100 100	105 107	mV mV	
$V_{\text{SNS(TRKL)}}$	Trickle Current Sense Voltage	$V_{\text{BAT}} = 0\text{V}$ (Note 3)		5	10	15	mV
V_{TRKL}	Trickle Charge Threshold Voltage	V_{BAT} Rising		4.7	5	5.3	V
V_{UV}	V_{CC} Undervoltage Lockout Threshold Voltage	V_{CC} Rising		7.5	8.5		V
ΔV_{UV}	V_{CC} Undervoltage Lockout Hysteresis Voltage			500			mV
V_{MSD}	Manual Shutdown Threshold Voltage	COMP Pin Falling		200	350	500	mV
V_{ASD}	Automatic Shutdown Threshold Voltage	$V_{\text{CC}} - V_{\text{BAT}}$		250			mV
I_{COMP}	COMP Pin Output Current	$V_{\text{COMP}} = 1.2\text{V}$		100			μA
I_{CHRG}	CHRG Pin Weak Pull-Down Current	$V_{\text{CHRG}} = 1\text{V}$		15	25	35	μA
V_{CHRG}	CHRG Pin Output Low Voltage	$I_{\text{CHRG}} = 1\text{mA}$		0.15	0.3		V
R_{EOC}	End-of-Charge Ratio	$V_{\text{SNS(EOC)}}/V_{\text{SNS(CHG)}}$		5	10	15	%
t_{TIMER}	Charge Time Accuracy				10		%
I_{NTC}	NTC Pin Output Current	$V_{\text{NTC}} = 0.85\text{V}$	● 75	85	95	μA	

ELECTRICAL CHARACTERISTICS (LTC4002-8.4) The ● denotes the specifications which apply over the full operating temperature range, otherwise specifications are at $T_A = 25^\circ\text{C}$. $V_{CC} = 12\text{V}$ unless otherwise noted.

SYMBOL	PARAMETER	CONDITIONS	MIN	TYP	MAX	UNITS
$V_{\text{NTC-HOT}}$	NTC Pin Threshold Voltage (Hot)	V_{NTC} Falling Hysteresis	● 340	355 25	370	mV mV
$V_{\text{NTC-COLD}}$	NTC Pin Threshold Voltage (Cold)	V_{NTC} Rising Hysteresis	● 2.428	2.465 170	2.502	V mV
ΔV_{RECHRG}	Recharge Battery Voltage Offset from Full Charged Battery Voltage	$V_{\text{BAT(FULLCHARGED)}} - V_{\text{RECHRG}}$, V_{BAT} Falling	200	300	400	mV
I_{LEAK}	CHRG Pin Leakage Current	$V_{\text{CHRG}} = 8\text{V}$, Charging Stops			1	μA

Oscillator

f_{OSC}	Switching Frequency		450	500	550	kHz
DC	Maximum Duty Cycle				100	%

Gate Drive

t_r	Rise Time	$C_{\text{GATE}} = 2000\text{pF}$, 10% to 90%		20		ns
t_f	Fall Time	$C_{\text{GATE}} = 2000\text{pF}$, 90% to 10%		50		ns
ΔV_{GATE}	Output Clamp Voltage	$V_{CC} - V_{\text{GATE}}$	●		8	V
ΔV_{GATEHI}	Output High Voltage	$\Delta V_{\text{GATEHI}} = V_{CC} - V_{\text{GATE}}$	●		0.3	V
ΔV_{GATELO}	Output Low Voltage	$\Delta V_{\text{GATELO}} = V_{CC} - V_{\text{GATE}}$	●	4.5		V

Note 1: Absolute Maximum Rating are those values beyond which the life of a device may be impaired.

Note 2: The LTC4002 is tested with Test Circuit 1.

Note 3: The LTC4002 is tested with Test Circuit 2.

Note 4: The LTC4002 is guaranteed to meet performance specifications from 0°C to 70°C . Specifications over the -40°C to 85°C operating temperature range are assured by design, characterization and correlation with statistical process controls.

TYPICAL PERFORMANCE CHARACTERISTICS $T_A = 25^\circ\text{C}$, $V_{CC} = 10\text{V}$ unless otherwise noted.

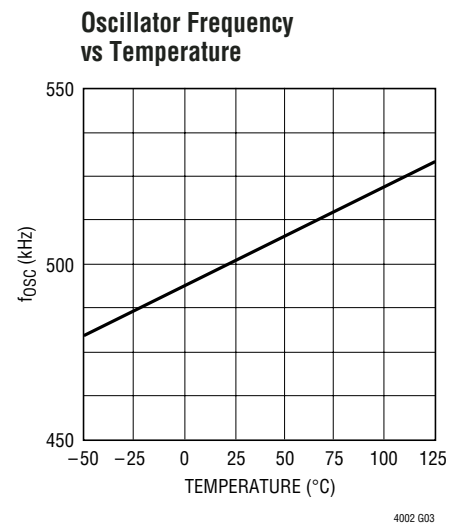
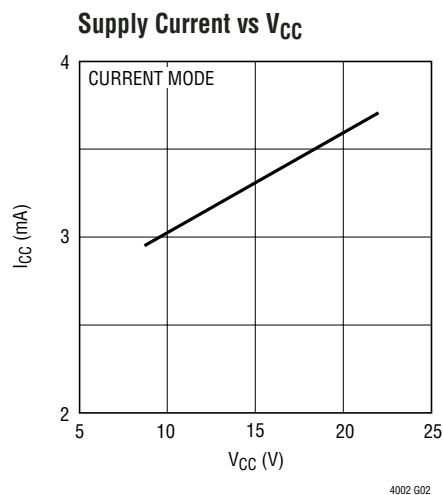
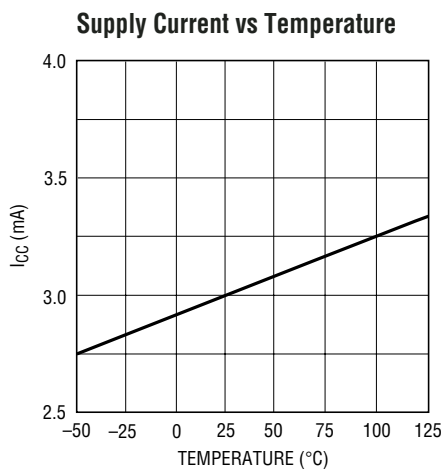

TYPICAL PERFORMANCE CHARACTERISTICS $T_A = 25^\circ\text{C}$, $V_{CC} = 10\text{V}$ unless otherwise noted.

Oscillator Frequency vs V_{CC}

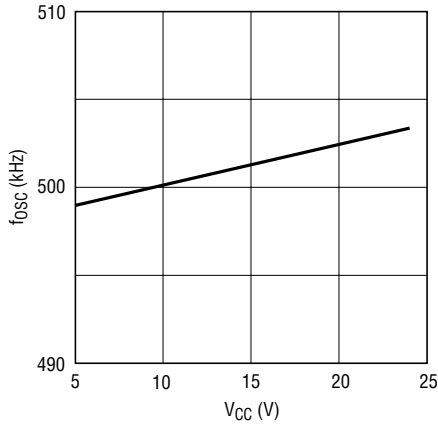

4002 G04

Undervoltage Lockout Threshold vs Temperature

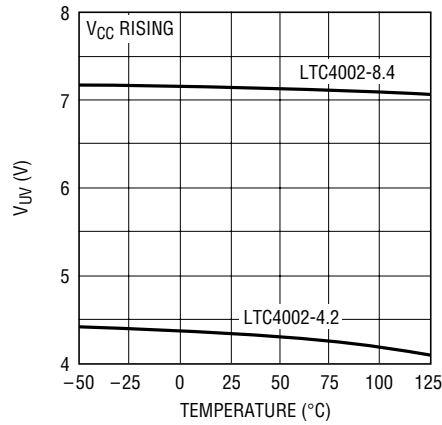

4002 G05

CHRG Pin Output Low Voltage vs V_{CC}

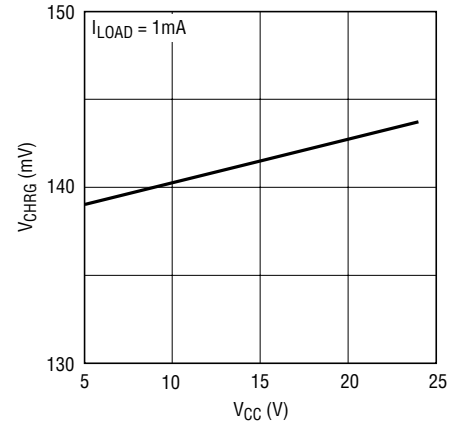

4002 G06

CHRG Pin Output Low Voltage vs Temperature

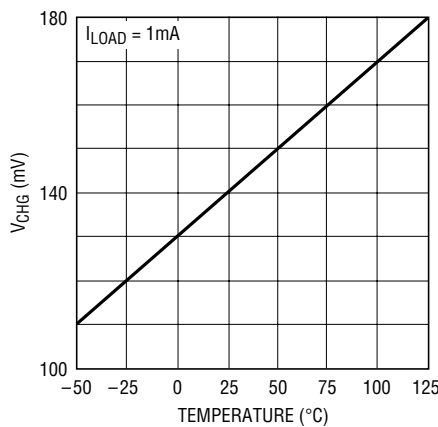

4002 G07

CHRG Pin Weak Pull-Down Current vs Temperature

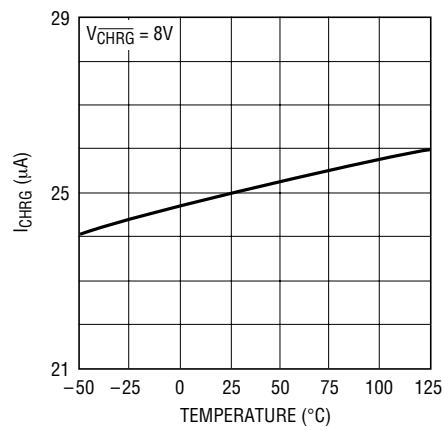

4002 G08

CHRG Output Pin Weak Pull-Down Current vs V_{CC}

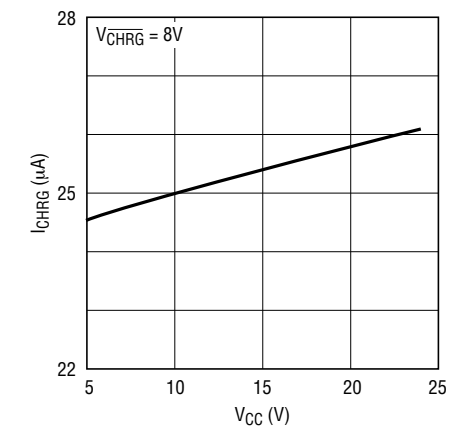

4002 G09

Recharge Voltage Offset Per Cell from Full Charged Voltage vs Temperature

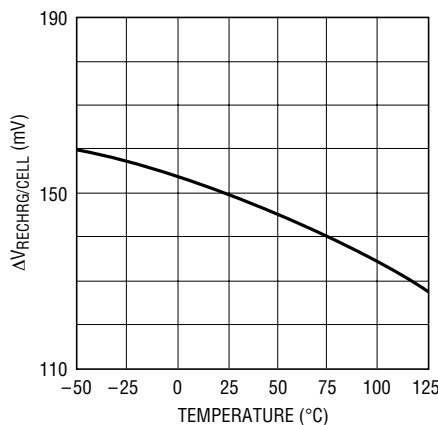

4002 G10

Recharge Voltage Offset from Full Charged Voltage vs V_{CC}

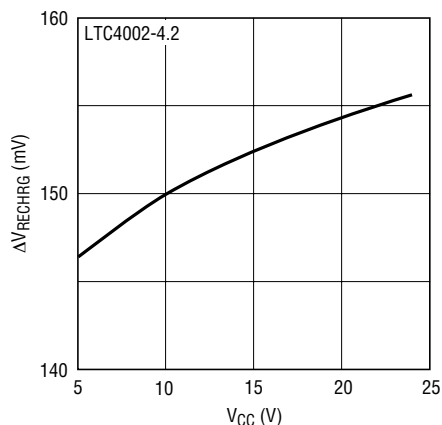

4002 G11

Recharge Voltage Offset from Full Charged Voltage vs V_{CC}

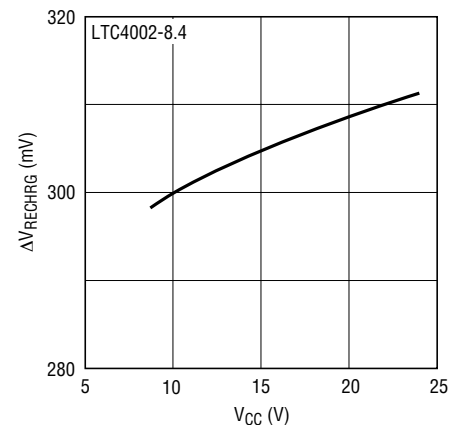

4002 G12

4002f

TYPICAL PERFORMANCE CHARACTERISTICS $T_A = 25^\circ\text{C}$, $V_{CC} = 10\text{V}$ unless otherwise noted.

Current Mode Sense Voltage vs Temperature

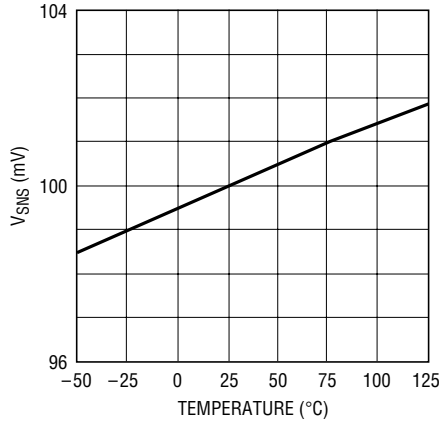

4002 G13

Current Mode Sense Voltage vs V_{CC}

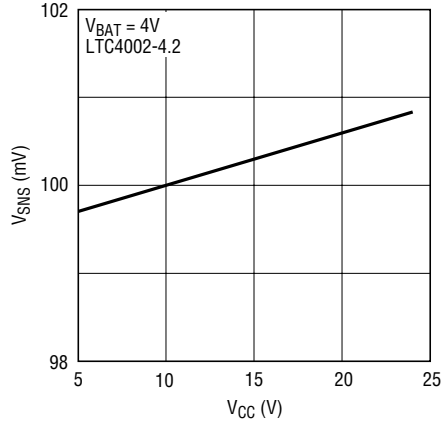

4002 G14

Current Mode Sense Voltage vs V_{CC}

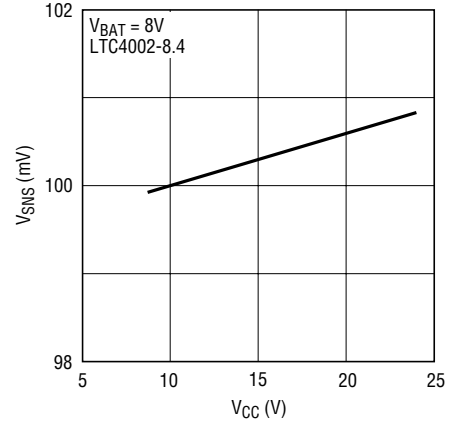

4002 G15

COMP Pin Output Current vs V_{CC}

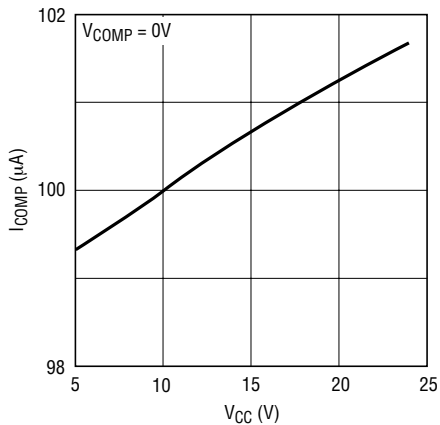

4002 G16

COMP Pin Output Current vs Temperature

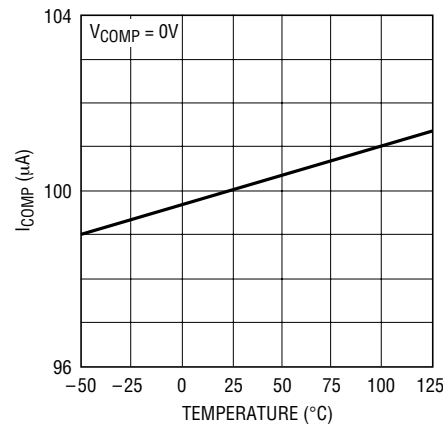

4002 G17

NTC Pin Output Current vs V_{CC}

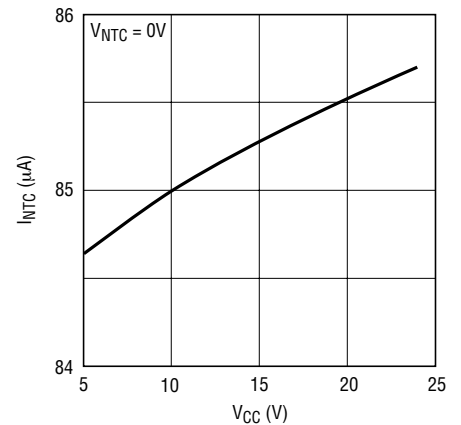

4002 G18

Trickle Charge Voltage vs Temperature

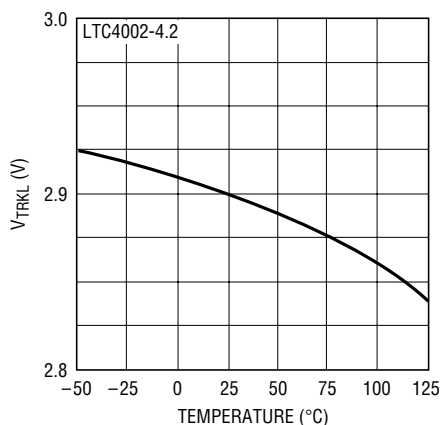

4002 G19

Trickle Charge Voltage vs V_{CC}

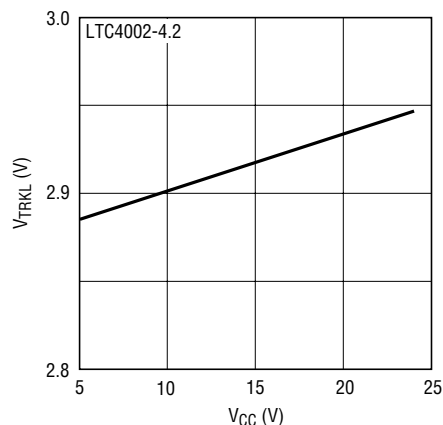

4002 G20

Trickle Charge Voltage vs Temperature

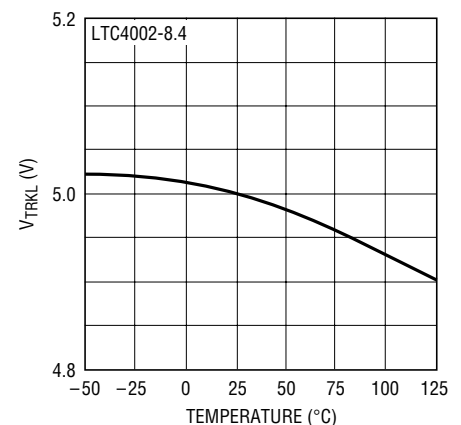

4002 G21

4002f

TYPICAL PERFORMANCE CHARACTERISTICS $T_A = 25^\circ\text{C}$, $V_{CC} = 10\text{V}$ unless otherwise noted.

Trickle Charge Voltage vs V_{CC}

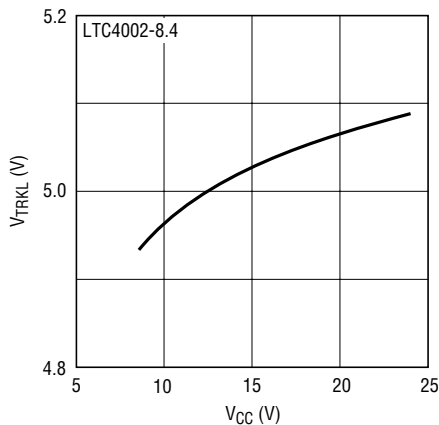

4002 G22

Trickle Charge Sense Voltage vs Temperature

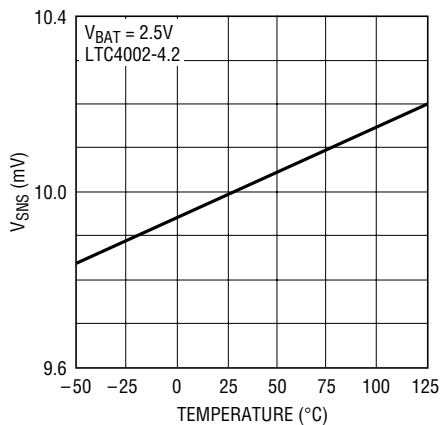

4002 G23

Trickle Charge Sense Voltage vs V_{CC}

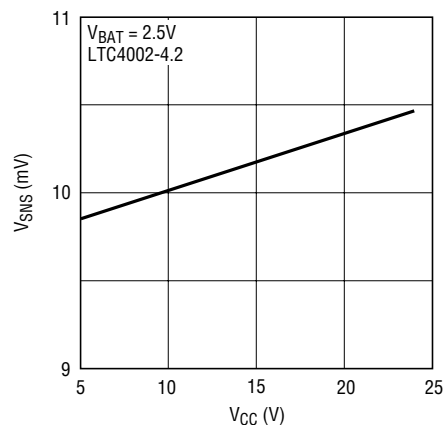

4002 G24

Trickle Charge Sense Voltage vs Temperature

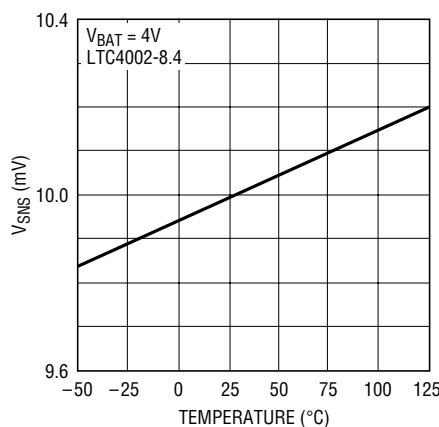

4002 G25

Trickle Charge Sense Voltage vs V_{CC}

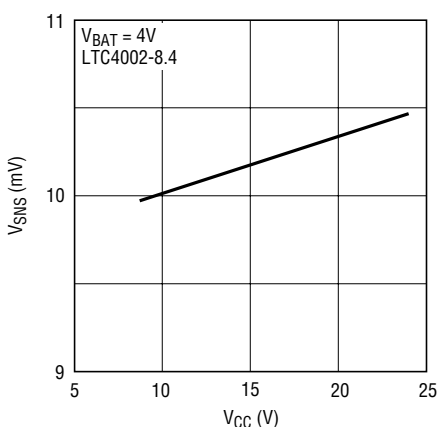

4002 G26

NTC Pin Output Current vs Temperature

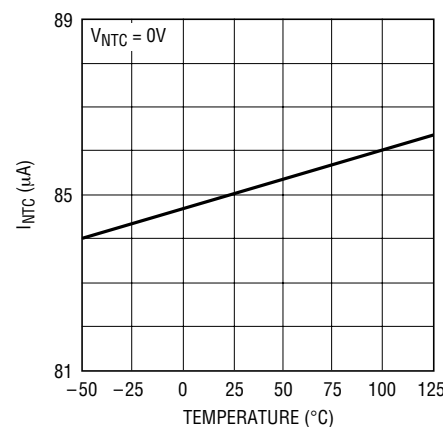

4002 G27

End-of-Charge Ratio vs Temperature

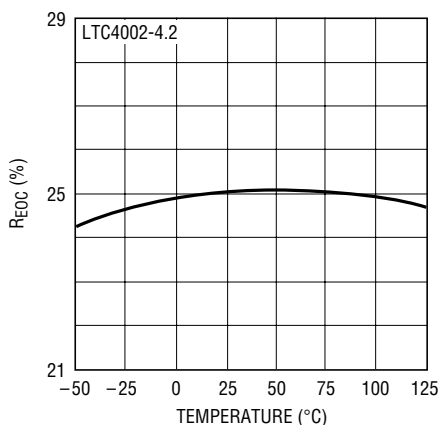

4002 G28

End-of-Charge Ratio vs V_{CC}

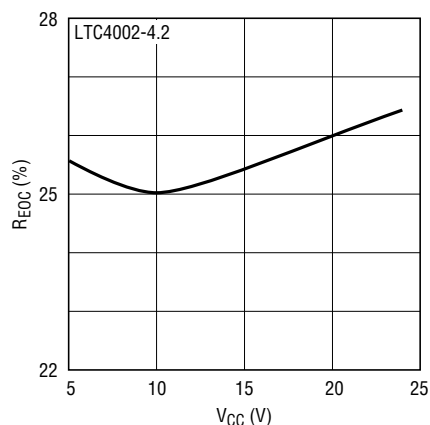

4002 G29

TYPICAL PERFORMANCE CHARACTERISTICS T_A = 25°C, V_{CC} = 10V unless otherwise noted.

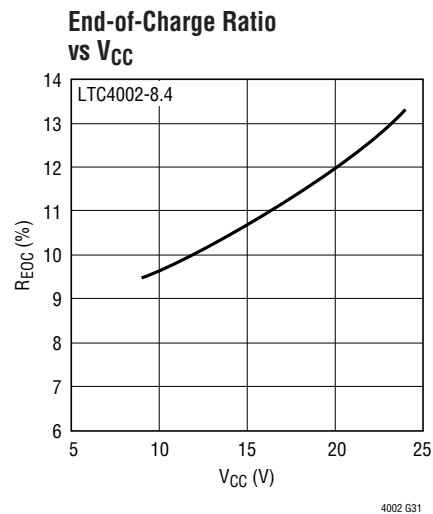
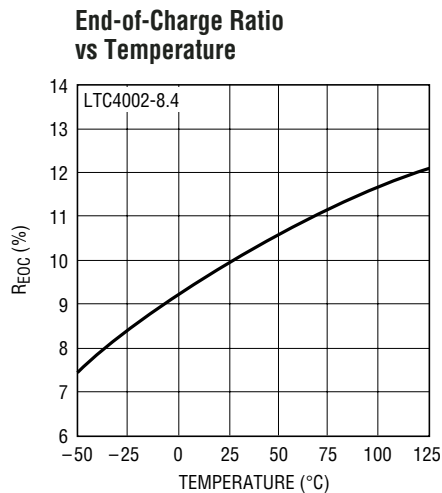

PIN FUNCTIONS (DFN/SO-8)

COMP (Pin 1/Pin 1): Compensation, Soft-Start and Shutdown Control Pin. The COMP pin is the control signal of the inner loop of the current mode PWM. Charging begins when the COMP pin reaches 800mV. The recommended compensation components are a 0.47μF (or larger) capacitor and a 2.2k series resistor. A 100μA current into the compensation capacitor also sets the soft-start slew rate. Pulling the COMP pin below 360mV will shut down the charger.

V_{CC} (Pin 2/Pin 2): Positive Supply Voltage Input. V_{CC} can range from V_{BAT(FLT)} + 0.5V to 22V. A 0.1μF or higher capacitor is required at the V_{CC} pin with the lead length kept to a minimum. A 10μF low ESR capacitor is also required at the source pins of the power P-channel MOSFET.

GATE (Pin 3/Pin 3): Gate Drive Output. Driver Output for the P-Channel MOSFET. The voltage at this pin is internally clamped to 8V below V_{CC}, allowing a low voltage MOSFET with gate-to-source breakdown voltage of 8V or less to be used.

PGND, SGND, Exposed Pad, GND (Pins 4, 5, 11/Pin 4): IC Ground. The exposed pad (DFN) must be soldered to PCB ground to provide both electrical contact and optimum thermal performance.

CHRG (Pin 6/Pin 5): Open-Drain Charge Status Output. When the battery is being charged, the CHRG pin is pulled low by an internal N-channel MOSFET. When the charge

current drops below the End-of-Charge threshold for more than 120μs, the N-channel MOSFET turns off and a 25μA current source is connected from the CHRG pin to GND. When the timer runs out or the input supply is removed, the 25μA current source is turned off and the CHRG pin becomes high impedance.

BAT (Pin 7/Pin 6): Battery Sense Input. A bypass capacitor of 22μF is required to minimize ripple voltage. An internal resistor divider, which is disconnected in sleep mode, sets the final float voltage at this pin. If the battery connection is opened when charging, an overvoltage circuit will limit the charger output voltage to 10% above the programmed float voltage.

When V_{BAT} is within 250mV of V_{CC}, the LTC4002 is forced into sleep mode, dropping I_{CC} to 10μA.

SENSE (Pin 8/Pin 7): Current Amplifier Sense Input. A sense resistor, R_{SENSE}, must be connected between the SENSE and BAT pins. The maximum charge current is equal to 100mV/R_{SENSE}.

NTC (Pin 9/Pin 8): NTC (Negative Temperature Coefficient) Thermistor Input. With an external 10kΩ NTC thermistor to ground, this pin senses the temperature of the battery pack and stops the charger when the temperature is out of range. When the voltage at this pin drops below 355mV at

PIN FUNCTIONS (DFN/SO-8)

hot temperature or rises above 2.465V at cold temperature, charging is suspended and the internal timer stops. The **CHRG** pin output is not affected during this hold state. To

disable the temperature qualification function, ground the NTC pin.

NC (Pin 10/NA): No Connect.

BLOCK DIAGRAM

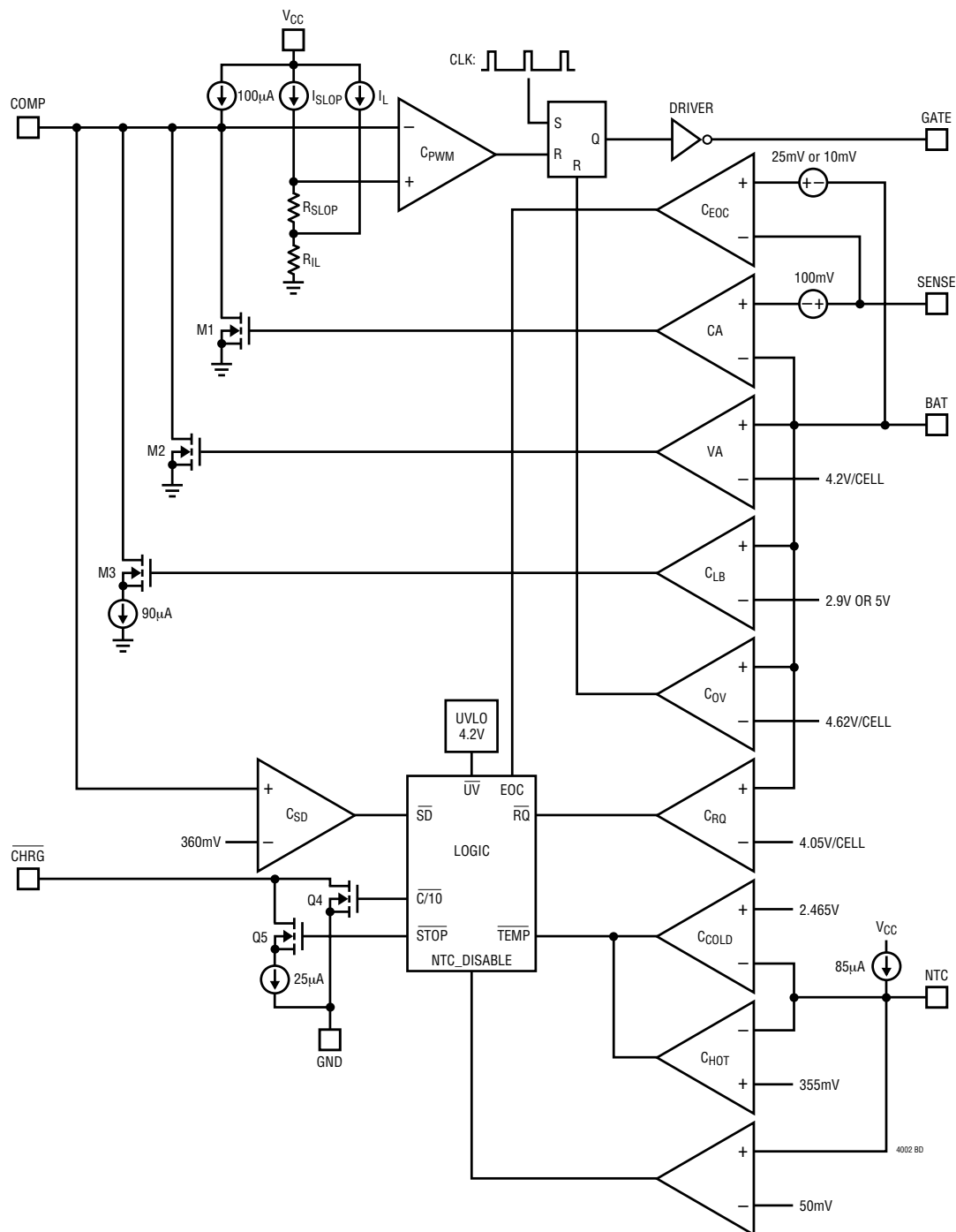

TEST CIRCUITS

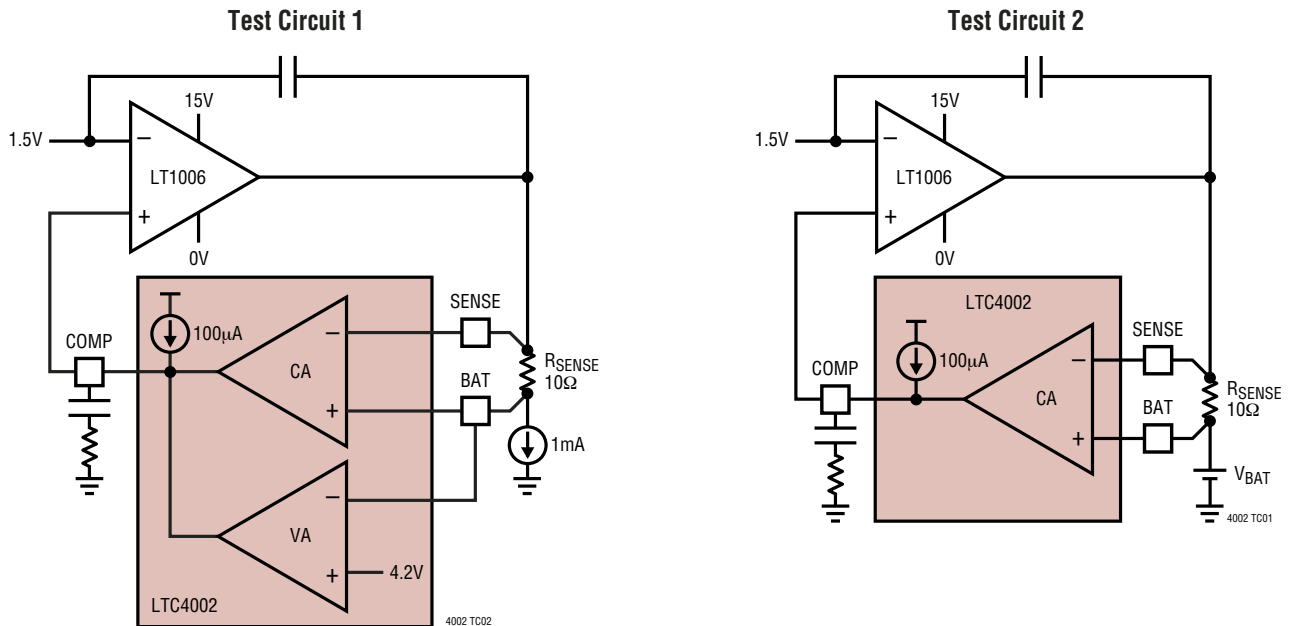

OPERATION

The LTC4002 is a constant current, constant voltage Li-Ion battery charger controller that uses a current mode PWM step-down (buck) switching architecture. The charge current is set by an external sense resistor (R_{SENSE}) across the SENSE and BAT pins. The final battery float voltage is internally set to 4.2V per cell. For batteries like lithium-ion that require accurate final float voltage, the internal 2.465V reference, voltage amplifier and the resistor divider provide regulation with $\pm 1\%$ accuracy.

A charge cycle begins when the voltage at the V_{CC} pin rises above the UVLO level and is 250mV or more greater than the battery voltage. At the beginning of the charge cycle, if the battery voltage is less than the trickle charge threshold, 2.9V for the 4.2 version and 5V for the 8.4 version, the charger goes into trickle charge mode. The trickle charge current is internally set to 10% of the full-scale current. If the battery voltage stays low for 30 minutes, the battery is considered faulty and the charge cycle is terminated.

When the battery voltage exceeds the trickle charge threshold, the charger goes into the full-scale constant current

charge mode. In constant current mode, the charge current is set by the external sense resistor R_{SENSE} and an internal 100mV reference; $I_{BAT} = 100\text{mV}/R_{SENSE}$.

When the battery voltage approaches the programmed float voltage, the charge current will start to decrease. When the current drops to 25% (4.2 version) or 10% (8.4 version) of the full-scale charge current, an internal comparator turns off the internal pull-down N-channel MOSFET at the CHRG pin, and connects a weak current source to ground to indicate a near end-of-charge condition.

An internal 3 hour timer determines the total charge time. After a time out occurs, the charge cycle is terminated and the CHRG pin is forced high impedance. To restart the charge cycle, remove and reapply the input voltage or momentarily shut the charger down. Also, a new charge cycle will begin if the battery voltage drops below the recharge threshold voltage of 4.05V per cell.

When the input voltage is present, the charger can be shut down ($I_{CC} = 3\text{mA}$) by pulling the COMP pin low. When the input voltage is not present, the charger goes into sleep

OPERATION

mode, dropping I_{CC} to $10\mu\text{A}$. This will greatly reduce the current drain on the battery and increase the standby time.

A $10\text{k}\Omega$ NTC (negative temperature coefficient) thermistor can be connected from the NTC pin to ground for battery

temperature qualification. The charge cycle is suspended when the temperature is outside of the 0°C to 50°C window (with DALE NTHS-1206N02).

APPLICATIONS INFORMATION

Undervoltage Lockout (UVLO)

An undervoltage lockout circuit monitors the input voltage and keeps the charger off until V_{CC} rises above the UVLO threshold (4.2V for the 4.2 version, 7.5V for the 8.4 version) and at least 250mV above the battery voltage. To prevent oscillation around the threshold voltage, the UVLO circuit has 200mV per cell of built-in hysteresis. When specifying minimum input voltage requirements, the voltage drop across the input blocking diode must be added to the minimum V_{CC} supply voltage specification.

Trickle Charge and Defective Battery Detection

At the beginning of a charge cycle, if the battery voltage is below the trickle charge threshold, the charger goes into trickle charge mode with the charge current reduced to 10% of the full-scale current. If the low-battery voltage persists for 30 minutes, the battery is considered defective, the charge cycle is terminated and the $\overline{\text{CHRG}}$ pin is forced high impedance.

Shutdown

The LTC4002 can be shut down by pulling the COMP pin to ground which pulls the GATE pin high turning off the external P-channel MOSFET. When the COMP pin is released, the internal timer is reset and a new charge cycle starts. In shutdown, the output of the $\overline{\text{CHRG}}$ pin is high impedance and the quiescent current remains at 3mA .

Removing the input power supply will put the charger into sleep mode. If the voltage at the V_{CC} pin drops below ($V_{\text{BAT}} + 250\text{mV}$) or below the UVLO level, the LTC4002 goes into a low current ($I_{CC} = 10\mu\text{A}$) sleep mode, reducing the battery drain current.

$\overline{\text{CHRG}}$ Status Output Pin

When a charge cycle starts, the $\overline{\text{CHRG}}$ pin is pulled to ground by an internal N-channel MOSFET which is capable of driving an LED. When the charge current drops below the End-of-Charge threshold for more than $120\mu\text{s}$, the N-channel MOSFET turns off and a weak $25\mu\text{A}$ current source to ground is connected to the $\overline{\text{CHRG}}$ pin. This weak $25\mu\text{A}$ pull-down remains until the timer ends the charge cycle, or the charger is in manual shutdown or sleep mode.

After a time out occurs (charge cycle ends), the pin will become high impedance. By using two different value resistors, a microprocessor can detect three states from this pin (charging, end-of-charge and charging stopped) see Figure 1.

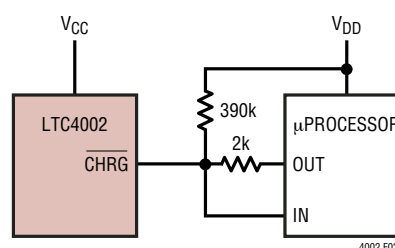

Figure 1. Microprocessor Interface

To detect the charge mode, force the digital output pin, OUT, high and measure the voltage at the CHRG pin. The N-channel MOSFET will pull the pin low even with a 2k pull-up resistor. Once the charge current drops below the End-of-Charge threshold, the N-channel MOSFET is turned off and a $25\mu\text{A}$ current source is connected to the $\overline{\text{CHRG}}$ pin. The IN pin will then be pulled high by the 2k resistor connected to OUT. Now force the OUT pin into a high

APPLICATIONS INFORMATION

impedance state, the current source will pull the pin low through the $390k$ resistor. When the internal timer has expired, the $\overline{\text{CHRG}}$ pin changes to a high impedance state and the $390k$ resistor will then pull the pin high to indicate charging has stopped.

Gate Drive

The LTC4002 gate driver can provide high transient currents to drive the external pass transistor. The rise and fall times are typically 20ns and 50ns respectively when driving a 2000pF load, which is typical for a P-channel MOSFET with $R_{\text{DS(ON)}}$ in the range of 50m Ω .

A voltage clamp is added to limit the gate drive to 8V below V_{CC} . For example, if V_{CC} is 10V then the GATE output will pull down to 2V max. This allows low voltage P-channel MOSFETs with superior $R_{\text{DS(ON)}}$ to be used as the pass transistor thus increasing efficiency.

Stability

Both the current loop and the voltage loop share a common, high impedance, compensation node ($\overline{\text{COMP}}$ pin). A series capacitor and resistor on this pin compensates both loops. The resistor is included to provide a zero in the loop response and boost the phase margin.

The compensation capacitor also provides a soft-start function for the charger. Upon start-up, the $\overline{\text{COMP}}$ pin voltage will quickly rise to 0.22V, due to the 2.2k series resistor, then ramp at a rate set by the internal 100 μA pull-up current source and the external capacitor. Battery charge current starts ramping up when the $\overline{\text{COMP}}$ pin voltage reaches 0.8V and full current is achieved with the

$\overline{\text{COMP}}$ pin at 1.3V. With a 0.47 μF capacitor, time to reach full charge current is about 2.35ms. Capacitance can be increased up to 1 μF if a longer start-up time is needed.

Automatic Battery Recharge

After the 3 hour charge cycle is completed and both the battery and the input power supply (wall adapter) are still connected, a new charge cycle will begin if the battery voltage drops below 4.05V per cell due to self-discharge or external loading. This will keep the battery capacity at more than 80% at all times without manually restarting the charge cycle.

Battery Temperature Detection

A negative temperature coefficient (NTC) thermistor located close to the battery pack can be used to monitor battery temperature and will not allow charging unless the battery temperature is within an acceptable range.

Connect a 10k Ω thermistor (DALE NTHS-1206N02) from the NTC pin to ground. If the temperature rises to 50 $^{\circ}\text{C}$, the resistance of the NTC will be approximately 4.1k Ω . With the 85 μA pull-up current source, the Hot temperature voltage threshold is 350mV. For Cold temperature, the voltage threshold is set at 2.465V which is equal to 0 $^{\circ}\text{C}$ ($R_{\text{NTC}} \approx 28.4k\Omega$) with 85 μA of pull-up current. If the temperature is outside the window, the GATE pin will be pulled up to V_{CC} and the timer frozen while the output status at the $\overline{\text{CHRG}}$ pin remains the same. The charge cycle begins or resumes once the temperature is within the acceptable range. Short the NTC pin to ground to disable the temperature qualification feature.

APPLICATIONS INFORMATION

Input and Output Capacitors

Since the input capacitor is assumed to absorb all input switching ripple current in the converter, it must have an adequate ripple current rating. Worst-case RMS ripple current is approximately one-half of output charge current. Actual capacitance value is not critical. Solid tantalum capacitors have a high ripple current rating in a relatively small surface mount package, but caution must be used when tantalum capacitors are used for input bypass. High input surge currents can be created when the adapter is hot-plugged to the charger and solid tantalum capacitors have a known failure mechanism when subjected to very high turn-on surge currents. Selecting the highest possible voltage rating on the capacitor will minimize problems. Consult with the manufacturer before use.

The selection of output capacitor C_{OUT} is primarily determined by the ESR required to minimize ripple voltage and load step transients. The output ripple ΔV_{OUT} is approximately bounded by:

$$\Delta V_{OUT} \leq \Delta I_L \left(ESR + \frac{1}{8f_{OSC}C_{OUT}} \right)$$

Since ΔI_L increases with input voltage, the output ripple is highest at maximum input voltage. Typically, once the ESR requirement is satisfied, the capacitance is adequate for filtering and has the necessary RMS current rating.

Switching ripple current splits between the battery and the output capacitor depending on the ESR of the output capacitor and the battery impedance. EMI considerations usually make it desirable to minimize ripple current in the battery leads. Ferrite beads or an inductor may be added to increase battery impedance at the 500kHz switching frequency. If the ESR of the output capacitor is 0.2Ω and the battery impedance is raised to 4Ω with a bead or inductor, only 5% of the current ripple will flow in the battery.

Design Example

As a design example, take a charger with the following specifications: $V_{IN} = 5V$ to $22V$, $V_{BAT} = 4V$ nominal, $I_{BAT} = 1.5A$, $f_{OSC} = 500kHz$, see Figure 2.

First, calculate the SENSE resistor :

$$R_{SENSE} = 100mV/1.5A = 68m\Omega$$

Choose the inductor for about 65% ripple current at the maximum V_{IN} :

$$L = \frac{4V}{(500kHz)(0.65)(1.5A)} \left(1 - \frac{4V}{22V} \right) = 6.713\mu H$$

Selecting a standard value of $6.8\mu H$ results in a maximum ripple current of :

$$\Delta I_L = \frac{4V}{(500kHz)(6.8\mu H)} \left(1 - \frac{4V}{22V} \right) = 962.6mA$$

PACKAGE DESCRIPTION

DD Package 10-Lead Plastic DFN (3mm × 3mm) (Reference LTC DWG # 05-08-1699)

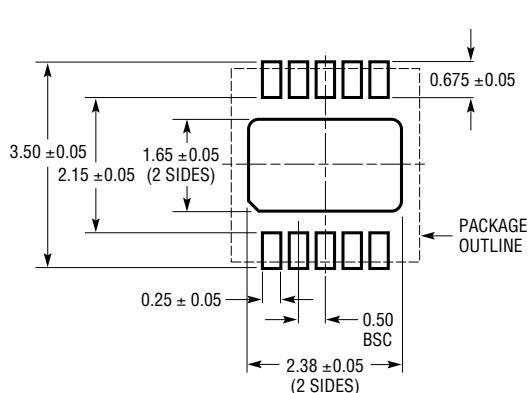

RECOMMENDED SOLDER PAD PITCH AND DIMENSIONS

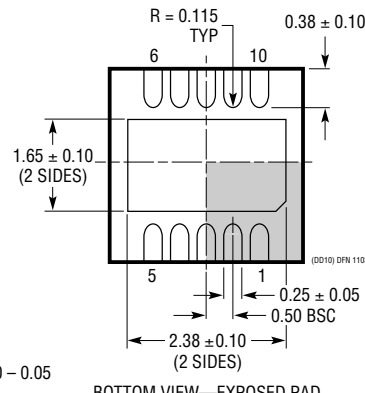
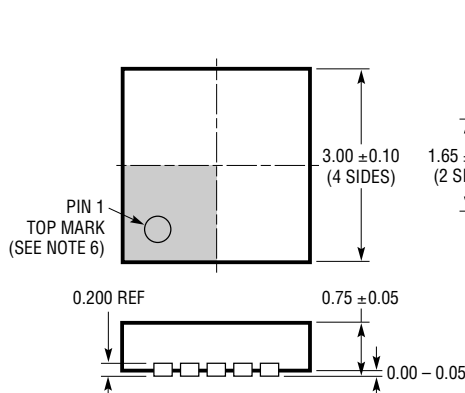

BOTTOM VIEW—EXPOSED PAD

NOTE:

1. DRAWING TO BE MADE A JEDEC PACKAGE OUTLINE M0-229 VARIATION OF (WEED-2). CHECK THE LTC WEBSITE DATA SHEET FOR CURRENT STATUS OF VARIATION ASSIGNMENT
2. DRAWING NOT TO SCALE
3. ALL DIMENSIONS ARE IN MILLIMETERS
4. DIMENSIONS OF EXPOSED PAD ON BOTTOM OF PACKAGE DO NOT INCLUDE MOLD FLASH. MOLD FLASH, IF PRESENT, SHALL NOT EXCEED 0.15mm ON ANY SIDE
5. EXPOSED PAD SHALL BE SOLDER PLATED
6. SHADED AREA IS ONLY A REFERENCE FOR PIN 1 LOCATION ON THE TOP AND BOTTOM OF PACKAGE

S8 Package 8-Lead Plastic Small Outline (Narrow .150 Inch) (Reference LTC DWG # 05-08-1610)

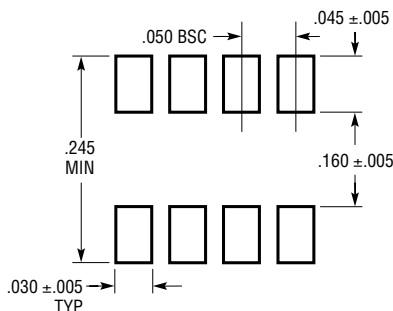

RECOMMENDED SOLDER PAD LAYOUT

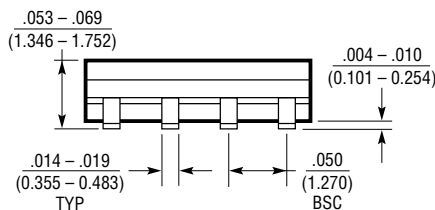
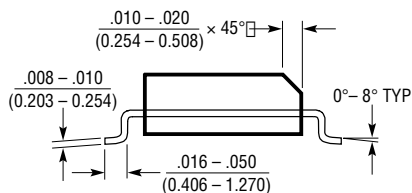
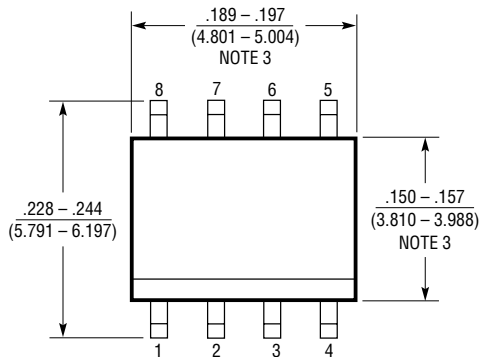

- NOTE:
1. DIMENSIONS IN INCHES (MILLIMETERS)
 2. DRAWING NOT TO SCALE
 3. THESE DIMENSIONS DO NOT INCLUDE MOLD FLASH OR PROTRUSIONS. MOLD FLASH OR PROTRUSIONS SHALL NOT EXCEED .006" (0.15mm)

S08 0303

TYPICAL APPLICATION

2-Cell 8.4V, 2A Li-Ion Battery Charger

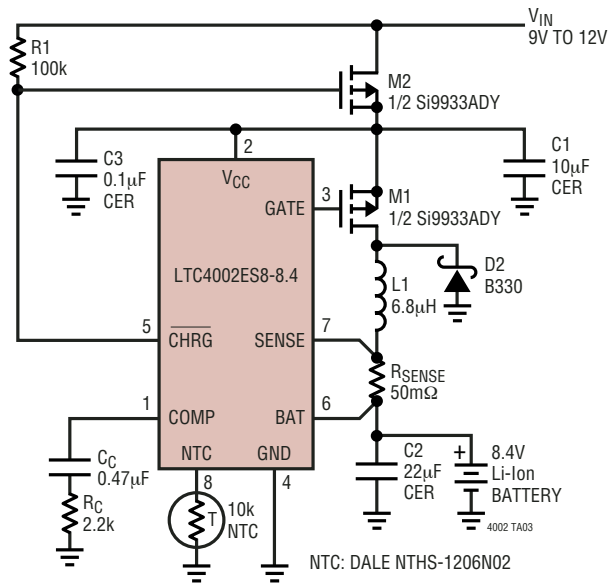

RELATED PARTS

PART NUMBER	DESCRIPTION	COMMENTS
LTC1732-8.4	2-Cell Li-Ion Linear Battery Charger	$8.8V \leq V_{IN} \leq 12V$; Programmable Charge Termination Timer Standalone Charger
LTC1733	Li-Ion Battery Charger with Thermal Regulation	Standalone Charger, Constant-Current/Constant-Voltage/Constant-Temperature, Integrated MOSFET, No External Sense Resistor or Blocking Diodes
LTC1734/LTC1734L	SOT-23 Li-Ion Battery Chargers	Need Only Two External Components, Monitors Charge Current, No Reverse Diode or Sense Resistor Required, 50mA to 700mA
LTC1980	Combination Battery Charger and DC/DC Converter	Wall Adapter May Be Above or Below Battery Voltage, Standalone, 1-, 2-Cell Li-Ion, Also for Charging NiMH and NiCd Batteries
LTC4006/LTC4007 LTC4008	4A Multiple Cell Li-Ion, NiCd, NiMH, Lead Acid Battery Chargers	$6V \leq V_{IN} \leq 28V$, High Efficiency $\geq 90\%$, $V_{OUT} \leq 28V$, Digital Interface I/O, Small Inductor
LTC4052/LTC1730	Integrated Pulse Chargers for a 1-Cell Li-Ion Battery	0.35Ω Internal N-FET Requires No Blocking Diode, Current Limit for Safety
LTC4053	USB Compatible Li-Ion Linear Battery Charger	Charges from USB Input or AC/DC, 100mA/500mA Up to 1.25A, Thermal Regulation, Fully Integrated
LTC4054	Standalone Linear Li-Ion Battery Charger with Integrated Pass Transistor in ThinSOT™	Thermal Regulation Prevents Overheating, C/10 Termination, C/10 Indicator
LTC4056	Standalone SOT-23 Li-Ion Linear Battery Charger	Charge Termination Included, $I_{CH} \leq 700mA$, 8-Lead ThinSOT Package
LTC4412/LTC4413	Low Loss PowerPath™ Controllers in ThinSOT	Automatic Switching Between DC Sources, Simplified Load Sharing

PowerPath and ThinSOT are trademarks of Linear Technology Corporation.

Компания «Океан Электроники» предлагает заключение долгосрочных отношений при поставках импортных электронных компонентов на взаимовыгодных условиях!

Наши преимущества:

- Поставка оригинальных импортных электронных компонентов напрямую с производств Америки, Европы и Азии, а так же с крупнейших складов мира;
- Широкая линейка поставок активных и пассивных импортных электронных компонентов (более 30 млн. наименований);
- Поставка сложных, дефицитных, либо снятых с производства позиций;
- Оперативные сроки поставки под заказ (от 5 рабочих дней);
- Экспресс доставка в любую точку России;
- Помощь Конструкторского Отдела и консультации квалифицированных инженеров;
- Техническая поддержка проекта, помощь в подборе аналогов, поставка прототипов;
- Поставка электронных компонентов под контролем ВП;
- Система менеджмента качества сертифицирована по Международному стандарту ISO 9001;
- При необходимости вся продукция военного и аэрокосмического назначения проходит испытания и сертификацию в лаборатории (по согласованию с заказчиком);
- Поставка специализированных компонентов военного и аэрокосмического уровня качества (Xilinx, Altera, Analog Devices, Intersil, Interpoint, Microsemi, Actel, Aeroflex, Peregrine, VPT, Syfer, Eurofarad, Texas Instruments, MS Kennedy, Miteq, Cobham, E2V, MA-COM, Hittite, Mini-Circuits, General Dynamics и др.);

Компания «Океан Электроники» является официальным дистрибьютором и эксклюзивным представителем в России одного из крупнейших производителей разъемов военного и аэрокосмического назначения «JONHON», а так же официальным дистрибьютором и эксклюзивным представителем в России производителя высокотехнологичных и надежных решений для передачи СВЧ сигналов «FORSTAR».



JONHON

«JONHON» (основан в 1970 г.)

Разъемы специального, военного и аэрокосмического назначения:

(Применяются в военной, авиационной, аэрокосмической, морской, железнодорожной, горно- и нефтедобывающей отраслях промышленности)

«FORSTAR» (основан в 1998 г.)

ВЧ соединители, коаксиальные кабели, кабельные сборки и микроволновые компоненты:

(Применяются в телекоммуникациях гражданского и специального назначения, в средствах связи, РЛС, а так же военной, авиационной и аэрокосмической отраслях промышленности).



Телефон: 8 (812) 309-75-97 (многоканальный)

Факс: 8 (812) 320-03-32

Электронная почта: ocean@oceanchips.ru

Web: <http://oceanchips.ru/>

Адрес: 198099, г. Санкт-Петербург, ул. Калинина, д. 2, корп. 4, лит. А