

Telpower® Compact Fused Disconnect Switch

TPC & TPCDS

TPC & TPCDS

TPCDS - Telpower® Compact Fused Disconnect Switch

TPC - Telpower® Compact Fuse - Current Limiting

Ampere Ratings: 3-125A

Available Ratings: 3, 4, 5, 6, 7, 8, 10, 12, 15, 20, 25, 30, 40, 50, 60, 75, 90, 100, 125A

Voltage Rating: 80Vdc

Interrupting Rating: 100,000A

Agency Information: **CE**

UL Recognized (investigated to UL 1801) as a disconnect switch for the interruption of load current by means of withdrawing the fuse pullout.

Recognized to U.S. and Canadian requirements under the component recognition program of Underwriters Laboratories Inc.

Files E219046 and E56412.



General Information:

- Fusible solution for replacement of existing dc Telecom circuit breakers.
- Compact size fused disconnect switch.
- AmpColor ID™ System for easy fuse replacement.
- Available in two disconnect switch profiles in addition to a variety of terminal styles.
- Local and remote open fuse indication.
Local alarm indication provided by LED on TPC fuse.
- Remote alarm terminal available in three positions commonly found in dc circuit protection devices.
- Recommended .75 inch center-to-center product spacing.
- Current-limiting capability
- Complete system coordination capability.
- Highest interrupting rating (100,000A) available for dc circuit protection of this footprint.
- No venting of arc or molten metals and gases during fuse opening.
- Fuse material: Black thermoplastic, UL rated 94 V-O, 170° C RTI.
- Housing material: Black thermoplastic, UL rated 94 V-O, 120° C RTI.

CE CE logo denotes compliance with European Union Low Voltage Directive (50-1000Vac, 75-1500Vdc). Refer to Data Sheet: 8002 or contact Bussmann Application Engineering for more information.

Catalog Number	Description	Ampere Rating
TPC-3	Compact Fuse	3A
TPC-4	Compact Fuse	4A
TPC-5	Compact Fuse	5A
TPC-6	Compact Fuse	6A
TPC-7	Compact Fuse	7A
TPC-8	Compact Fuse	8A
TPC-10	Compact Fuse	10A
TPC-12	Compact Fuse	12A
TPC-15	Compact Fuse	15A
TPC-20	Compact Fuse	20A
TPC-25	Compact Fuse	25A
TPC-30	Compact Fuse	30A
TPC-40	Compact Fuse	40A
TPC-50	Compact Fuse	50A
TPC-60	Compact Fuse	60A
TPC-75	Compact Fuse	75A
TPC-90	Compact Fuse	90A
TPC-100	Compact Fuse	100A
TPC-125	Compact Fuse	125A
TPCDS-BBE-1	Compact Disconnect	3-125A
TPCDS-BBE-2	Compact Disconnect	3-125A
TPCDS-BBE-3	Compact Disconnect	3-125A
TPCDS-BBM-1	Compact Disconnect	3-125A
TPCDS-BBM-2	Compact Disconnect	3-125A
TPCDS-BBM-3	Compact Disconnect	3-125A
TPCDS-BSE-1	Compact Disconnect	3-125A
TPCDS-BSE-2	Compact Disconnect	3-125A
TPCDS-BSE-3	Compact Disconnect	3-125A
TPCDS-BSM-1	Compact Disconnect	3-125A
TPCDS-BSM-2	Compact Disconnect	3-125A
TPCDS-BSM-3	Compact Disconnect	3-125A
TPCDS-SSE-1	Compact Disconnect	3-125A
TPCDS-SSE-2	Compact Disconnect	3-125A
TPCDS-SSE-3	Compact Disconnect	3-125A
TPCDS-SSM-1	Compact Disconnect	3-125A
TPCDS-SSM-2	Compact Disconnect	3-125A
TPCDS-SSM-3	Compact Disconnect	3-125A
TPCDS-D-BC1*	Compact Disconnect	3-125A
TPCDS-D-BC2*	Compact Disconnect	3-125A
TPCDS-D-CC1*	Compact Disconnect	3-125A
TPCDS-D-SEC1*	Compact Disconnect	3-125A
TPCDS-D-SEC2*	Compact Disconnect	3-125A
TPCDS-D-SMC1*	Compact Disconnect	3-125A
TPCDS-D-SMC2*	Compact Disconnect	3-125A

*Not investigated to Canadian Requirements.

Telpower® Compact Fused Disconnect Switch

TPC & TPCDS

Compact Fused Disconnect Switch

- Bullet and / or stud terminals for line and load connections (1.940 inch / 49.3 mm spacing).
- Front access with bullet terminals.
Rear access with stud terminals.
- Three terminal style configurations available (see below).
- Remote alarm terminal available in three positions common to dc circuit protection devices.

Part Number System --

Compact Fused Disconnect Switch

To identify part number, replace block with appropriate suffix to identify line and load terminals, thread type, and alarm terminal distance.

TPCDS - TELPOWER® Compact Fused Disconnect Switch



Terminal Style (select one)

- BB - Bullet contact on the line
Bullet contact on the load
- BS - Bullet contact on the line
Stud terminal on the load
- SS - Stud terminal on the line
Stud terminal on the load

Thread (select one)

- M - Metric threads for panel mount fasteners (M3) and stud (M5)
- E - English threads for panel mount fasteners (6-32) and stud (10-32)

Remote Alarm Terminal Distance (select one)

- 1 - .645 inch from line terminal
- 2 - .970 inch from line terminal
- 3 - 1.285 inch from line terminal

DIN Rail Fused Disconnect Switch

- 35mm DIN rail mountable
- Front access.
- Three terminal style configurations available (see below).
- Screw clamp accepts 10 to 1 AWG (6mm² - 50mm²) wire.
- Two remote alarm terminal positions available.

Part Number System --

DIN Rail Fused Disconnect Switch

To identify part number, replace block with appropriate suffix to identify line and load terminals, thread type if applicable, and alarm terminal option.

TPCDS - TELPOWER® Compact Fused Disconnect Switch D - DIN-Rail style product



Terminal Style (select one)

- CC - Screw Clamp terminal on the line
Screw Clamp terminal on the load
- BC - Bullet contact on the line
Screw Clamp terminal on the load
- SEC - Stud terminal on the line
English threads for stud (10-32)
Screw Clamp terminal on the load
- SMC - Stud terminal on the line
Metric threads for stud (M5)
Screw Clamp terminal on the load

Remote Alarm Terminal Location (select one)

- 1 - Side output
(available on CC and BC terminal styles)
- 2 - Bottom output, .970 inch from line terminal
(available on BC terminal style only)

The only controlled copy of this Data Sheet is the electronic read-only version located on the Bussmann Network Drive. All other copies of this document are by definition uncontrolled. This bulletin is intended to clearly present comprehensive product data and provide technical information that will help the end user with design applications. Bussmann reserves the right, without notice, to change design or construction of any products and to discontinue or limit distribution of any products. Bussmann also reserves the right to change or update, without notice, any technical information contained in this bulletin. Once a product has been selected, it should be tested by the user in all possible applications.

TPCDS Terminal Styles

Compact Fused Disconnect Switch



Line: Bullet Load: Bullet

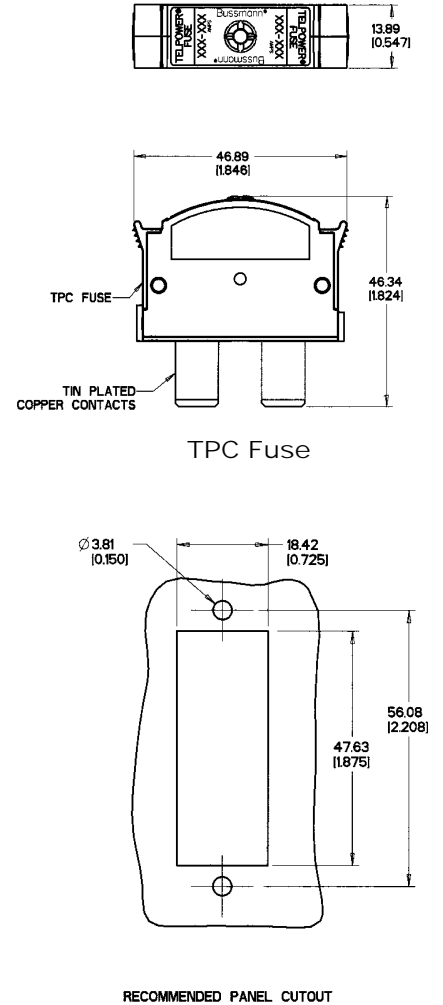

Line: Bullet Load: Stud Line: Stud Load: Stud

Telpower® Compact Fused Disconnect Switch

TPC & TPCDS

TPCDS-D Terminal Styles
DIN Rail Fused Disconnect Switch

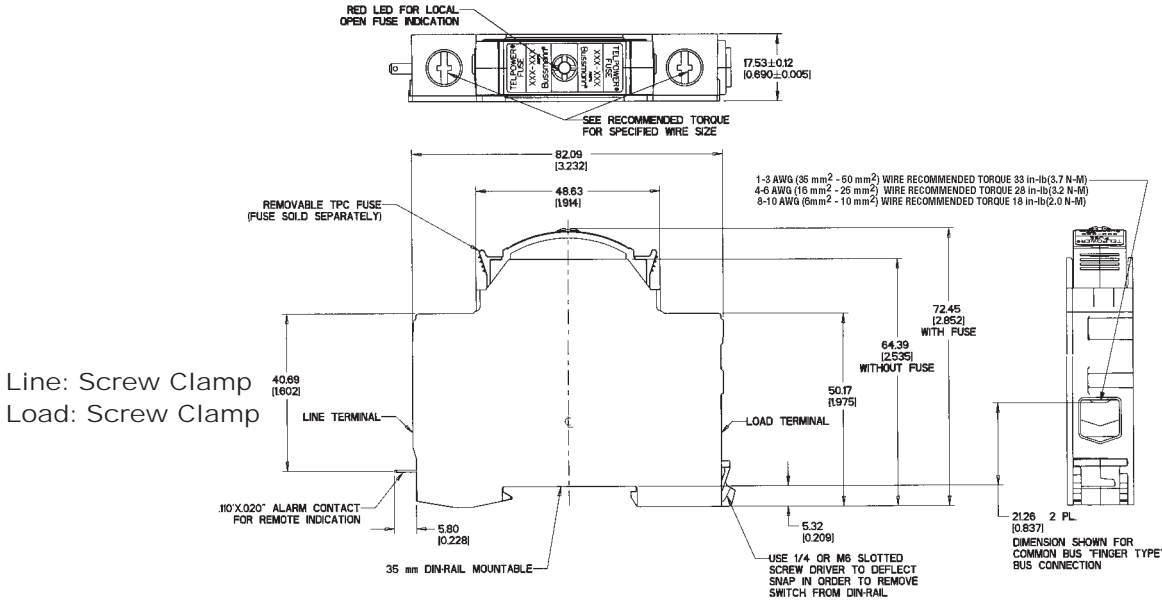

Alarm Schematic



NOTES:

- The Electronic Monitoring Circuit (EMC) is a high input impedance device that will provide alarming for an open-fuse condition.
- Typical leakage current through the load when the EMC is operational ≤ 2 mA.
- The resistance, R, must be provided by the end-user to limit the alarm output current to a maximum of 20 mA. The value, R, should be calculated using the system voltage value.
 - If remote alarm functionality is not required, the *END-USER CIRCUITRY* must still be supplied to provide a resistive path to the return for the local alarm to properly function.
- The fuse is polarized to maintain proper orientation with the switch housing. The line and load terminals are identified on the switch housing.
- Electrical integrity of the load must be maintained after fuse has opened in order for the local and remote alarm to properly function.

AmpColor ID™ System

Bussmann®
TELPOWER®
Technology

Use This Chart to
Manage Your
Telpower®
Fused Disconnect
Switches.

Welcome to the AmpColor ID™ System. Please reference this chart to determine which replacement Telpower fuse is needed.

Each amp rating is represented by a specific color or combination of colors.

Please place matching AmpColor label on panel to identify ampere position. For use with Telpower® TPC fuses and TPM fuses.

COOPER Bussmann

For the latest product information and updates visit
www.telpoweronline.com

Chart Reorder no. 3A0347

3A	25A
4A	30A
5A	40A
6A	50A
7A	60A
8A	75A
10A	90A
12A	100A
15A	125A
20A	TELPOWER® Technology

AmpColor ID™ System for Telpower® TPC and TPM fuses.
Bussmann® 9-01-5M

AmpColor ID™ Chart included with each box of ten TPC fuses.



TPC Fuses: 3-125A
TPM Fuses: 3-30A

Reference Data Sheet: 5022 for TPM fuse specifications.

Twelve AmpColor ID™ tags included with each box of ten TPC fuses.

Telpower's AmpColor ID™ System Is Easy to Use. Each Amp rating is represented by a specific color. Simply label new or existing panels with the appropriate AmpColor tags and post the AmpColor chart nearby. Personnel can quickly and accurately reference the chart for the appropriate replacement fuse.

75A
TPC-75

125A
TPC-125

30A
TPC-30

AmpColor ID™ tags

Telpower® Compact Fused Disconnect Switch

TPC & TPCDS



Time-Current Characteristic Curve—Average Melt - 3-20 Amp

Telpower® Compact Fused Disconnect Switch

TPC & TPCDS



Time-Current Characteristic Curve—Average Melt - 25-125 Amp

The only controlled copy of this Data Sheet is the electronic read-only version located on the Bussmann Network Drive. All other copies of this document are by definition uncontrolled. This bulletin is intended to clearly present comprehensive product data and provide technical information that will help the end user with design applications. Bussmann reserves the right, without notice, to change design or construction of any products and to discontinue or limit distribution of any products. Bussmann also reserves the right to change or update, without notice, any technical information contained in this bulletin. Once a product has been selected, it should be tested by the user in all possible applications.

Компания «Океан Электроники» предлагает заключение долгосрочных отношений при поставках импортных электронных компонентов на взаимовыгодных условиях!

Наши преимущества:

- Поставка оригинальных импортных электронных компонентов напрямую с производств Америки, Европы и Азии, а так же с крупнейших складов мира;
- Широкая линейка поставок активных и пассивных импортных электронных компонентов (более 30 млн. наименований);
- Поставка сложных, дефицитных, либо снятых с производства позиций;
- Оперативные сроки поставки под заказ (от 5 рабочих дней);
- Экспресс доставка в любую точку России;
- Помощь Конструкторского Отдела и консультации квалифицированных инженеров;
- Техническая поддержка проекта, помощь в подборе аналогов, поставка прототипов;
- Поставка электронных компонентов под контролем ВП;
- Система менеджмента качества сертифицирована по Международному стандарту ISO 9001;
- При необходимости вся продукция военного и аэрокосмического назначения проходит испытания и сертификацию в лаборатории (по согласованию с заказчиком);
- Поставка специализированных компонентов военного и аэрокосмического уровня качества (Xilinx, Altera, Analog Devices, Intersil, Interpoint, Microsemi, Actel, Aeroflex, Peregrine, VPT, Syfer, Eurofarad, Texas Instruments, MS Kennedy, Miteq, Cobham, E2V, MA-COM, Hittite, Mini-Circuits, General Dynamics и др.);

Компания «Океан Электроники» является официальным дистрибьютором и эксклюзивным представителем в России одного из крупнейших производителей разъемов военного и аэрокосмического назначения «JONHON», а так же официальным дистрибьютором и эксклюзивным представителем в России производителя высокотехнологичных и надежных решений для передачи СВЧ сигналов «FORSTAR».



JONHON

«JONHON» (основан в 1970 г.)

Разъемы специального, военного и аэрокосмического назначения:

(Применяются в военной, авиационной, аэрокосмической, морской, железнодорожной, горно- и нефтедобывающей отраслях промышленности)

«FORSTAR» (основан в 1998 г.)

ВЧ соединители, коаксиальные кабели, кабельные сборки и микроволновые компоненты:

(Применяются в телекоммуникациях гражданского и специального назначения, в средствах связи, РЛС, а так же военной, авиационной и аэрокосмической отраслях промышленности).



Телефон: 8 (812) 309-75-97 (многоканальный)

Факс: 8 (812) 320-03-32

Электронная почта: ocean@oceanchips.ru

Web: <http://oceanchips.ru/>

Адрес: 198099, г. Санкт-Петербург, ул. Калинина, д. 2, корп. 4, лит. А