

SMLW36 series

Actual size
 7950(3120)
 7.9×5.0mm(t=1.1mm)

Features

•High heat dissipation, high efficiency white LEDs

Color Type WB

Specifications

Part No.	Chip Structure	Emitting Color	Absolute Maximum Ratings (Ta=25°C)					Electrical and Optical Characteristics (Ta=25°C)								
			Power Dissipation Pd(mW)	Forward Current IF(mA)	Peak Forward Current I _F P(mA)	Operating Temperature Topr(°C)	Storage Temperature Tstg(°C)	Forward Voltage V _F Typ.(V)	IF(mA)	Chromaticity Coordinates (x, y)	IF(mA)	Luminous Intensity I _v			Luminous Flux Φ _v	
											Min. (mcd)	Typ. (mcd)	IF(mA)	Typ. (lm)	IF(mA)	
<input type="checkbox"/> SMLW36WBFAW	InGaN	High Color Rend. (5000K)	420	105	400	-40 to +85	-40 to +100	3.4	90	(0.36,0.36)	90	4.8	7.0	90	(25)	90
<input type="checkbox"/> SMLW36WBFBW		High Color Rend. (3000K)								(0.44,0.40)					(20)	
<input type="checkbox"/> SMLW36WBFCW		White								5.8		8.5	90	(30,0.28)	(30)	
<input type="checkbox"/> SMLW36WBFDW																

Dimensions

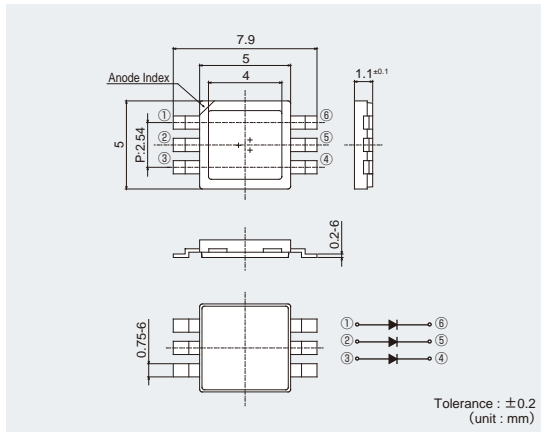

Recommended Solder Pattern

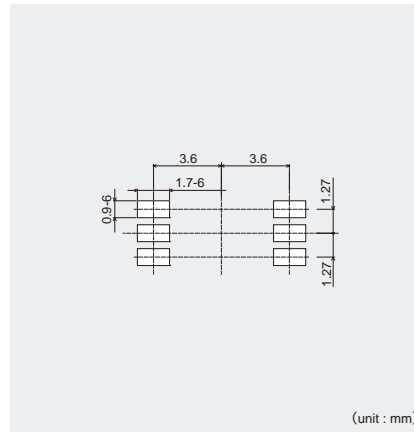

Viewing Angle

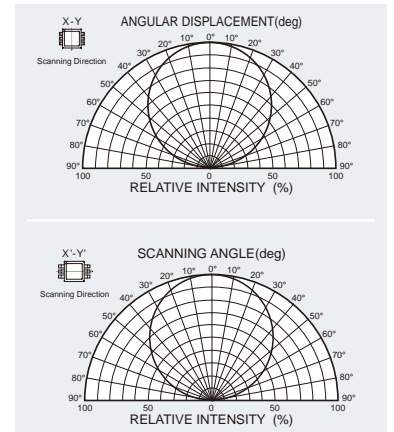

Electrical Characteristics Curves

■ Forward Current-Forward Voltage

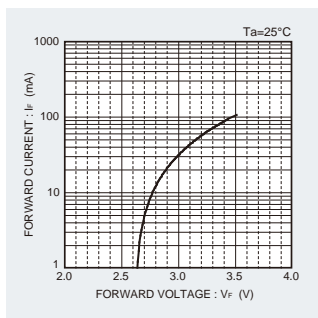

■ Luminous Intensity-Atmosphere Temperature

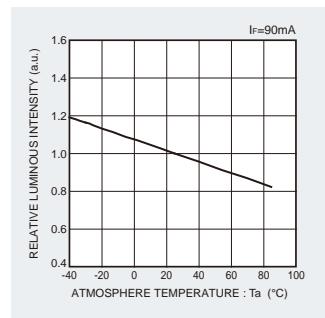

■ Luminous Intensity-Forward Current

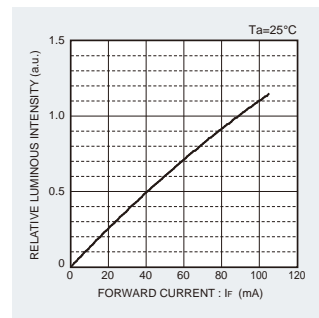

■ Derating

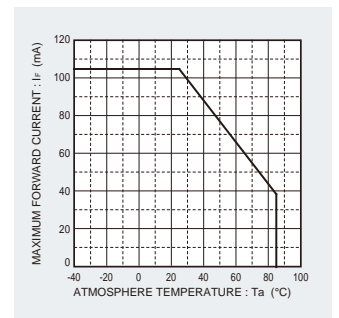

- SMLW36WBFAW
- SMLW36WBFBW
- SMLW36WBFCW
- SMLW36WBFDW

- SMLW36WBFAW
- SMLW36WBFBW
- SMLW36WBFCW
- SMLW36WBFDW

- SMLW36WBFAW
- SMLW36WBFBW
- SMLW36WBFCW
- SMLW36WBFDW

- SMLW36WBFAW
- SMLW36WBFBW
- SMLW36WBFCW
- SMLW36WBFDW

Rank Reference of Brightness

■ White (WB)

Package type	Package size (mm)	Height (mm)	Luminous intensity (cd)	Rank																		
				C	D	E	F	G	H	J	K	L	M	N	P	Q	R	S	T	U		
Chip LEDs with Reflector	7950	1.1	90	2.2 to 2.8	2.8 to 3.3	3.3 to 4.0	4.0 to 4.8	4.8 to 5.8	5.8 to 7.0	7.0 to 8.5	8.5 to 10.2	10.2 to 12.3	12.3 to 14.8	14.8 to 19	19 to 21.8	21.8 to 24.5	24.5 to 27.2	27.2 to 29.3	29.3 to 32.6	32.6 to 35.4		
				SMLW36WBFAW																		
				SMLW36WBFBW																		
				SMLW36WBFCW																		
SMLW36WBFDW																						

※Brightness on specification sheet include tolerance of within ± 10%.

Chromaticity Diagram

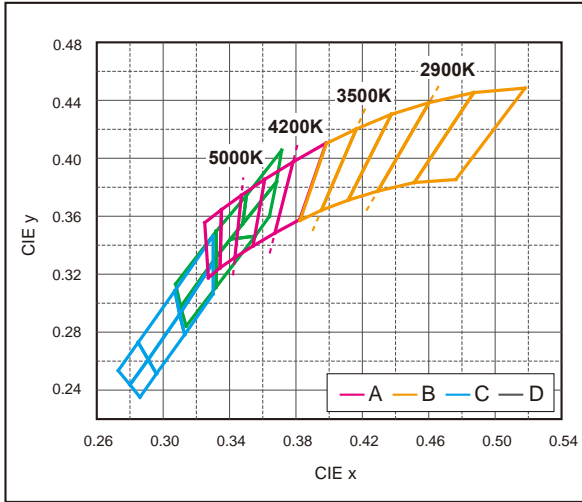

Part No. Construction

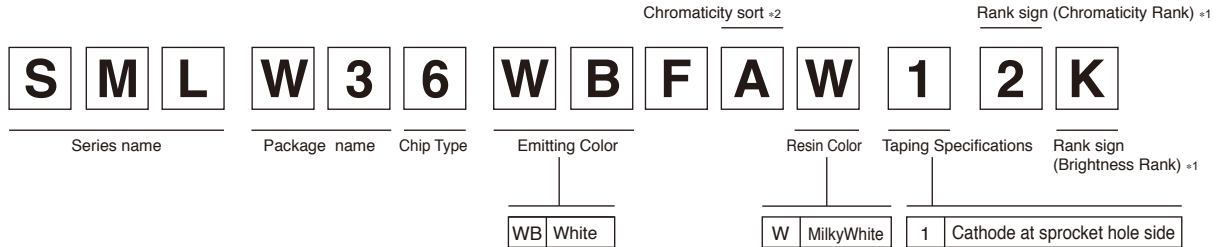

- ※1 Concerning the rank sign.
 - Please refer to the rank chart above for luminous intensity classification.
 - Please refer to the Specification sheet for color classification.
 - Part name is individual for each rank.
 - When shipped as sample, the part name will be a representative part name.
- General products are free of ranks. Please contact sales if rank appointment is needed.
- ※2: Please refer to Chromaticity diagram.

Packing Specification

ROHM LED products are being shipped with desiccant (silica gel) concluded in moisture-proof bags. Pasting the moisture sensitive label on the outer surface of the moisture-proof bags or enclosing the humidity indication card inside the bag is available upon request. Please contact the nearest sales office or distributor if necessary.

Notes

No copying or reproduction of this document, in part or in whole, is permitted without the consent of ROHM Co.,Ltd.

The content specified herein is subject to change for improvement without notice.

The content specified herein is for the purpose of introducing ROHM's products (hereinafter "Products"). If you wish to use any such Product, please be sure to refer to the specifications, which can be obtained from ROHM upon request.

Examples of application circuits, circuit constants and any other information contained herein illustrate the standard usage and operations of the Products. The peripheral conditions must be taken into account when designing circuits for mass production.

Great care was taken in ensuring the accuracy of the information specified in this document. However, should you incur any damage arising from any inaccuracy or misprint of such information, ROHM shall bear no responsibility for such damage.

The technical information specified herein is intended only to show the typical functions of and examples of application circuits for the Products. ROHM does not grant you, explicitly or implicitly, any license to use or exercise intellectual property or other rights held by ROHM and other parties. ROHM shall bear no responsibility whatsoever for any dispute arising from the use of such technical information.

The Products specified in this document are intended to be used with general-use electronic equipment or devices (such as audio visual equipment, office-automation equipment, communication devices, electronic appliances and amusement devices).

The Products specified in this document are not designed to be radiation tolerant.

While ROHM always makes efforts to enhance the quality and reliability of its Products, a Product may fail or malfunction for a variety of reasons.

Please be sure to implement in your equipment using the Products safety measures to guard against the possibility of physical injury, fire or any other damage caused in the event of the failure of any Product, such as derating, redundancy, fire control and fail-safe designs. ROHM shall bear no responsibility whatsoever for your use of any Product outside of the prescribed scope or not in accordance with the instruction manual.

The Products are not designed or manufactured to be used with any equipment, device or system which requires an extremely high level of reliability the failure or malfunction of which may result in a direct threat to human life or create a risk of human injury (such as a medical instrument, transportation equipment, aerospace machinery, nuclear-reactor controller, fuel-controller or other safety device). ROHM shall bear no responsibility in any way for use of any of the Products for the above special purposes. If a Product is intended to be used for any such special purpose, please contact a ROHM sales representative before purchasing.

If you intend to export or ship overseas any Product or technology specified herein that may be controlled under the Foreign Exchange and the Foreign Trade Law, you will be required to obtain a license or permit under the Law.



Thank you for your accessing to ROHM product informations.
More detail product informations and catalogs are available, please contact us.

ROHM Customer Support System

<http://www.rohm.com/contact/>

Mouser Electronics

Authorized Distributor

Click to View Pricing, Inventory, Delivery & Lifecycle Information:

[ROHM Semiconductor:](#)

[SMLW36WBFCW1](#) [SMLW36WBFBW1](#) [SMLW36WBFDW1](#) [SMLW36WBFAW1](#)

Компания «Океан Электроники» предлагает заключение долгосрочных отношений при поставках импортных электронных компонентов на взаимовыгодных условиях!

Наши преимущества:

- Поставка оригинальных импортных электронных компонентов напрямую с производств Америки, Европы и Азии, а так же с крупнейших складов мира;
- Широкая линейка поставок активных и пассивных импортных электронных компонентов (более 30 млн. наименований);
- Поставка сложных, дефицитных, либо снятых с производства позиций;
- Оперативные сроки поставки под заказ (от 5 рабочих дней);
- Экспресс доставка в любую точку России;
- Помощь Конструкторского Отдела и консультации квалифицированных инженеров;
- Техническая поддержка проекта, помощь в подборе аналогов, поставка прототипов;
- Поставка электронных компонентов под контролем ВП;
- Система менеджмента качества сертифицирована по Международному стандарту ISO 9001;
- При необходимости вся продукция военного и аэрокосмического назначения проходит испытания и сертификацию в лаборатории (по согласованию с заказчиком);
- Поставка специализированных компонентов военного и аэрокосмического уровня качества (Xilinx, Altera, Analog Devices, Intersil, Interpoint, Microsemi, Actel, Aeroflex, Peregrine, VPT, Syfer, Eurofarad, Texas Instruments, MS Kennedy, Miteq, Cobham, E2V, MA-COM, Hittite, Mini-Circuits, General Dynamics и др.);

Компания «Океан Электроники» является официальным дистрибьютором и эксклюзивным представителем в России одного из крупнейших производителей разъемов военного и аэрокосмического назначения «JONHON», а так же официальным дистрибьютором и эксклюзивным представителем в России производителя высокотехнологичных и надежных решений для передачи СВЧ сигналов «FORSTAR».



JONHON

«JONHON» (основан в 1970 г.)

Разъемы специального, военного и аэрокосмического назначения:

(Применяются в военной, авиационной, аэрокосмической, морской, железнодорожной, горно- и нефтедобывающей отраслях промышленности)

«FORSTAR» (основан в 1998 г.)

ВЧ соединители, коаксиальные кабели,
кабельные сборки и микроволновые компоненты:

(Применяются в телекоммуникациях гражданского и специального назначения, в средствах связи, РЛС, а так же военной, авиационной и аэрокосмической отраслях промышленности).



Телефон: 8 (812) 309-75-97 (многоканальный)

Факс: 8 (812) 320-03-32

Электронная почта: ocean@oceanchips.ru

Web: <http://oceanchips.ru/>

Адрес: 198099, г. Санкт-Петербург, ул. Калинина, д. 2, корп. 4, лит. А