

## LOW DROPOUT VOLTAGE REGULATOR

### ■ GENERAL DESCRIPTION

The NJM2867/68 is a 100mA output low dropout voltage regulator with ON/OFF control.

Advanced Bipolar technology achieves low noise, high ripple rejection and low quiescent current.

Small packaging, 0.1 $\mu$ F small decoupling capacitor, built-in noise bypass capacitor make the NJM2867/68 suitable for space conscious applications.

### ■ PACKAGE OUTLINE



NJM2867F3



NJM2867F/NJM2868F

### ■ FEATURES

- High Ripple Rejection      75dB typ. (f=1kHz Vo=3V Version)
- Output Noise Voltage      Vno=40 $\mu$ Vrms typ.
- Output capacitor with 0.1 $\mu$ F ceramic capacitor (Vo $\geq$ 2.8V)
- Output Current              Io(max.)=100mA
- High Precision Output      Vo $\pm$ 1.0%
- Low Dropout Voltage      0.10V typ. (Io=60mA)
- ON/OFF Control              (Active High)
- Internal Short Circuit Current Limit
- Internal Thermal Overload Protection
- Bipolar Technology
- Package Outline              SC88A (NJM2867F3), SOT-23-5 (NJM2867F/NJM2868F)

### ■ PIN CONFIGURATION

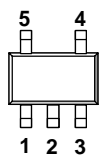

NJM2867F/NJM2867F3

- PIN FUNCTION**
- 1.CONTROL
  - 2.GND
  - 3.NC
  - 4.V<sub>OUT</sub>
  - 5.V<sub>IN</sub>

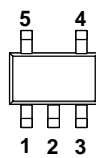

NJM2868F

- PIN FUNCTION**
1. V<sub>IN</sub>
  - 2.GND
  - 3.CONTROL
  - 4.NC
  - 5.V<sub>OUT</sub>

### ■ EQUIVALENT CIRCUIT

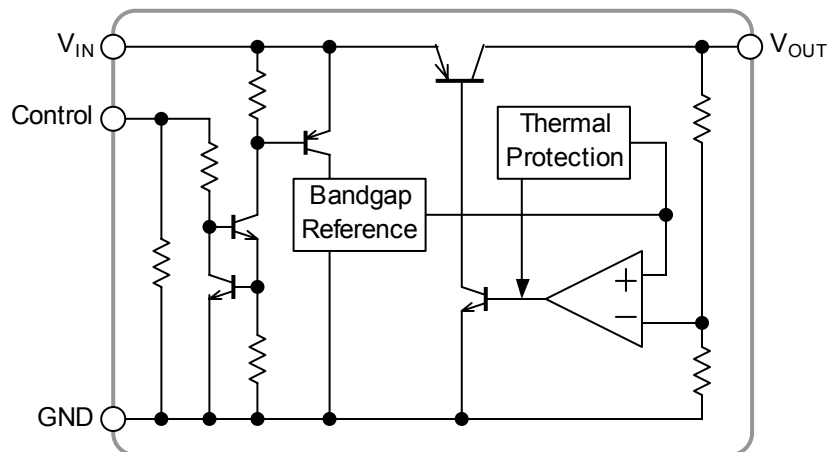

# NJM2867/68

## ■ OUTPUT VOLTAGE RANK LIST

### ●NJM2867

Device Name	V <sub>OUT</sub>	Device Name	V <sub>OUT</sub>	Device Name	V <sub>OUT</sub>
NJM2867F3-/F21	2.1V	NJM2867F3-/F29	2.9V	NJM2867F3-/F38	3.8V
NJM2867F3-/F24	2.4V	NJM2867F3-/F03	3.0V	NJM2867F3-/F04	4.0V
NJM2867F3-/F25	2.5V	NJM2867F3-/F31	3.1V	NJM2867F3-/F445	4.45V
NJM2867F3-/F26	2.6V	NJM2867F3-/F32	3.2V	NJM2867F3-/F05	5.0V
NJM2867F3-/F27	2.7V	NJM2867F3-/F33	3.3V		
NJM2867F3-/F28	2.8V	NJM2867F3-/F34	3.4V		

### ●NJM2868

Device Name	V <sub>OUT</sub>	Device Name	V <sub>OUT</sub>	Device Name	V <sub>OUT</sub>
NJM2868F21	2.1V	NJM2868F29	2.9V	NJM2868F38	3.8V
NJM2868F24	2.4V	NJM2868F03	3.0V	NJM2868F04	4.0V
NJM2868F25	2.5V	NJM2868F31	3.1V	NJM2868F445	4.45V
NJM2868F26	2.6V	NJM2868F32	3.2V	NJM2868F05	5.0V
NJM2868F27	2.7V	NJM2868F33	3.3V		
NJM2868F28	2.8V	NJM2868F34	3.4V		

## ■ ABSOLUTE MAXIMUM RATINGS

(Ta=25°C)

PARAMETER	SYMBOL	RATINGS		UNIT
Input Voltage	V <sub>IN</sub>	+14		V
Control Voltage	V <sub>CONT</sub>	+14(*1)		V
Power Dissipation	P <sub>D</sub>	SC88A	250(*2)	mW
		SOT-23-5	200(*3)	
			350(*2)	
Operating Temperature	Topr	-40~+85		°C
Storage Temperature	Tstg	-40~+125		°C

(\*1): When input voltage is less than +14V, the absolute maximum control voltage is equal to the input voltage.

(\*2): Mounted on glass epoxy board based on EIA/JEDEC. (114.3x76.2x1.6mm: 2Layers)

(\*3): Device itself.

## ■ ELECTRICAL CHARACTERISTICS

( $V_{IN}=V_O+1V$ ,  $C_{IN}=0.1\mu F$ ,  $C_O=0.1\mu F$  ( $2.3V < V_O \leq 2.8V$  :  $C_O=0.22\mu F$ ,  $V_O \leq 2.3V$ :  $C_O=0.47\mu F$ ),  $T_a=25^\circ C$ )

PARAMETER	SYMBOL	TEST CONDITION	MIN.	TYP.	MAX.	UNIT
Output Voltage	$V_O$	$I_O=30mA$	-1.0%	-	+1.0%	V
Quiescent Current	$I_Q$	$I_O=0mA$ , expect $I_{CONT}$	-	120	180	$\mu A$
Quiescent Current at Control OFF	$I_{Q(OFF)}$	$V_{CONT}=0V$	-	-	100	nA
Output Current	$I_O$	$V_O=0.3V$	100	130	-	mA
Line Regulation	$\Delta V_O / \Delta V_{IN}$	$V_{IN}=V_O+1V \sim V_O+6V$ , $I_O=30mA$	-	-	0.10	%/V
Load Regulation	$\Delta V_O / \Delta I_O$	$I_O=0 \sim 60mA$	-	-	0.03	%/mA
Dropout Voltage	$\Delta V_{L-O}$	$I_O=60mA$	-	0.10	0.18	V
Ripple Rejection	RR	$e_{in}=200mV_{rms}$ , $f=1kHz$ , $I_O=10mA$ , $V_O=3V$ Version	-	75	-	dB
Average Temperature Coefficient of Output Voltage	$\Delta V_O / \Delta T_a$	$T_a=0 \sim 85^\circ C$ , $I_O=10mA$	-	$\pm 50$	-	ppm/ $^\circ C$
Output Noise Voltage	$V_{NO}$	$f=10Hz \sim 80kHz$ , $I_O=10mA$ , $V_O=3V$ Version	-	40	-	$\mu V_{rms}$
Control Current	$I_{CONT}$	$V_{CONT}=1.6V$ , $I_O=0mA$	-	-	12	$\mu A$
Control Voltage for ON-state	$V_{CONT(ON)}$		1.6	-	-	V
Control Voltage for OFF-state	$V_{CONT(OFF)}$		-	-	0.6	V

The above specification is a common specification for all output voltages.

Therefore, it may be different from the individual specification for a specific output voltage.

## ■ TEST CIRCUIT

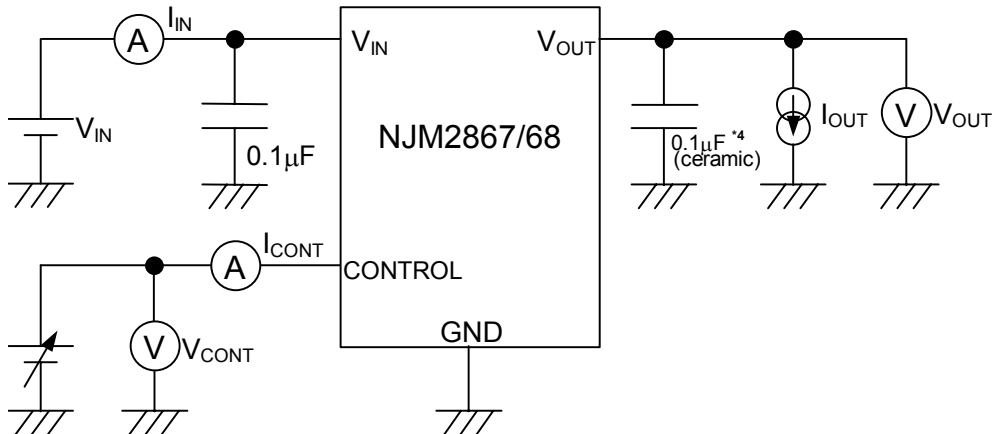

\*4 2.3V <  $V_O \leq 2.8V$  version:  $C_O=0.22\mu F$ (ceramic)  
 $V_O \leq 2.3V$  version:  $0.47\mu F$ (ceramic)

# NJM2867/68

## ■ TYPICAL APPLICATION

① In the case where ON/OFF Control is not required:

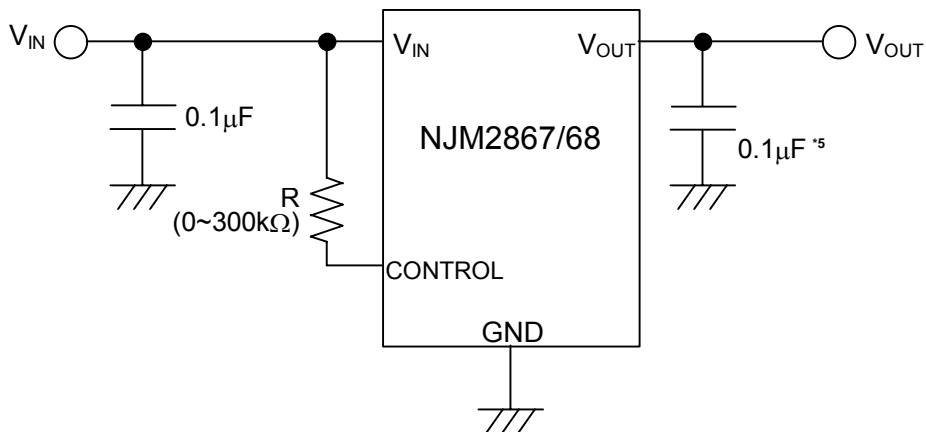

\*5 2.3V<V<sub>o</sub>≤2.8V version: C<sub>o</sub>=0.22µF  
V<sub>o</sub>≤2.3V version: 0.47µF

Connect control terminal to V<sub>IN</sub> terminal

② In use of ON/OFF CONTROL:

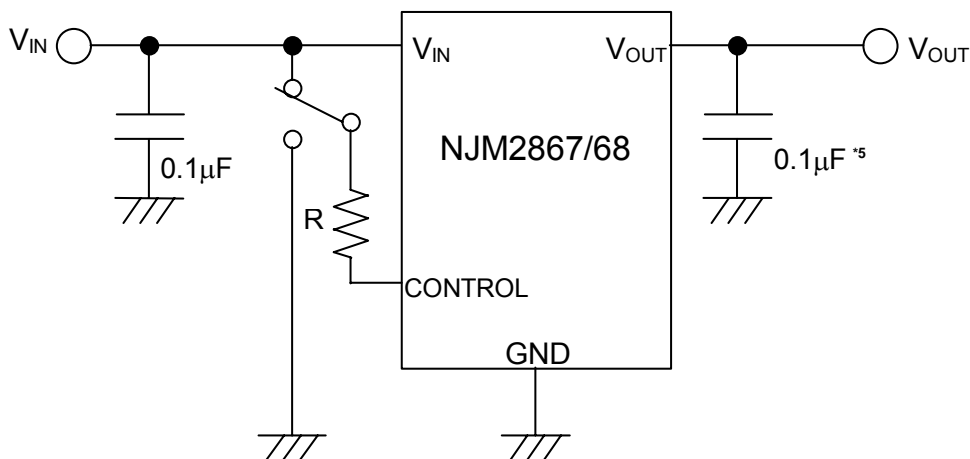

\*5 2.3V<V<sub>o</sub>≤2.8V version: C<sub>o</sub>=0.22µF  
V<sub>o</sub>≤2.3V version: 0.47µF

State of control terminal:

- “H”→ output is enabled.
- “L” or “open” → output is disabled.

\*In the case of using a resistance "R" between V<sub>IN</sub> and control.

The current flow into the control terminal while the IC is ON state (I<sub>CONT</sub>) can be reduced when a pull up resistance "R" is inserted between V<sub>IN</sub> and the control terminal.

The minimum control voltage for ON state (V<sub>CONT(ON)</sub>) is increased due to the voltage drop caused by I<sub>CONT</sub> and the resistance "R". The I<sub>CONT</sub> is temperature dependence as shown in the "Control Current vs. Temperature" characteristics. Therefore, the resistance "R" should be carefully selected to ensure the control voltage exceeds the V<sub>CONT(ON)</sub> over the required temperature range.

POWER DISSIPATION vs. AMBIENT TEMPERATURE

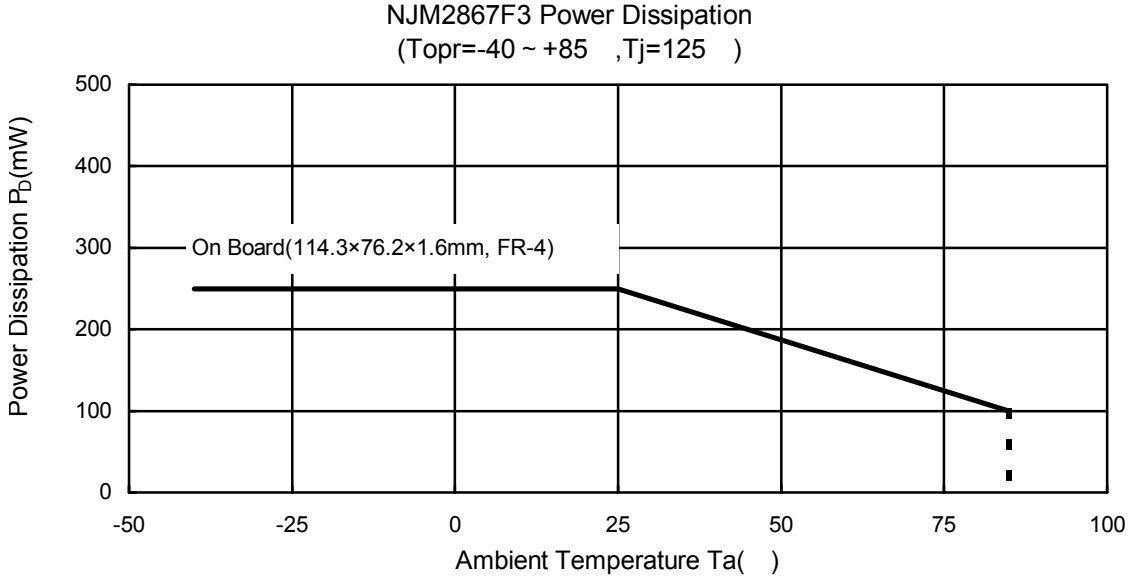
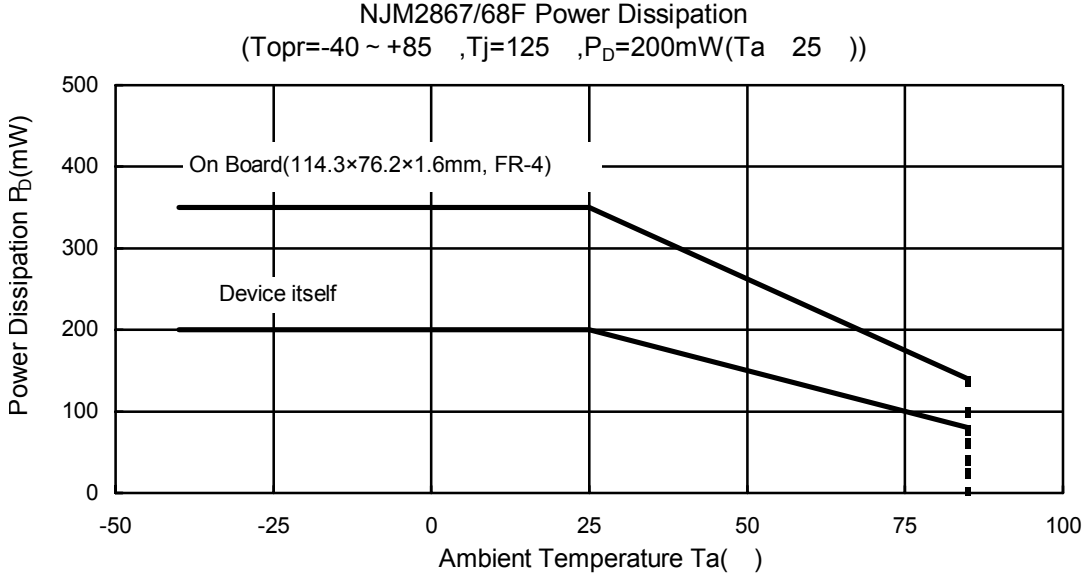

# NJM2867/68

## ■ ELECTRICAL CHARACTERISTICS

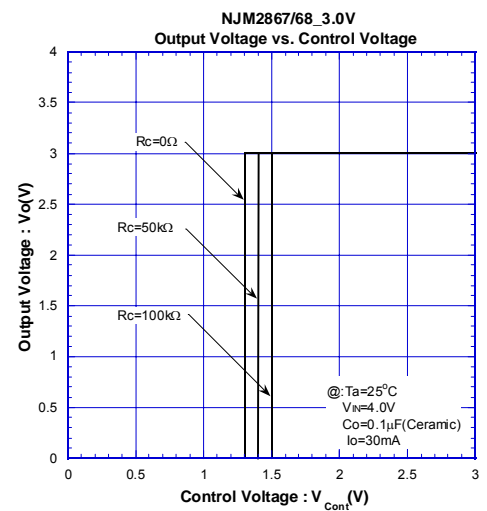
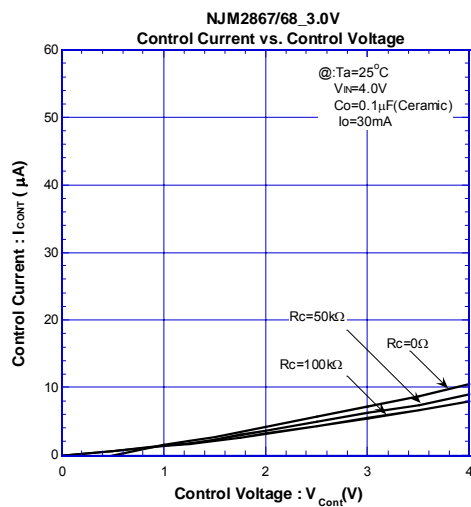
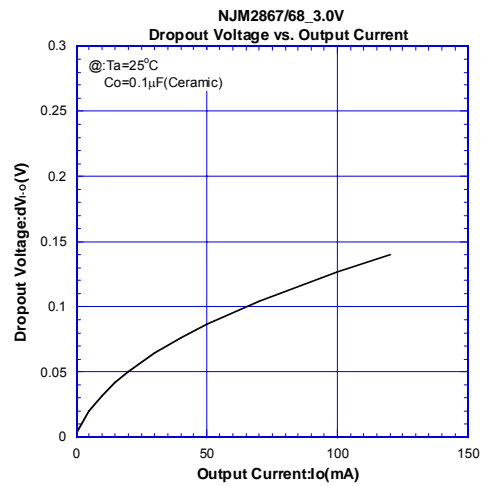
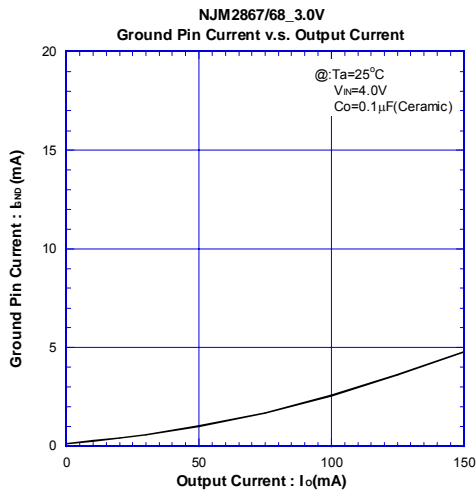
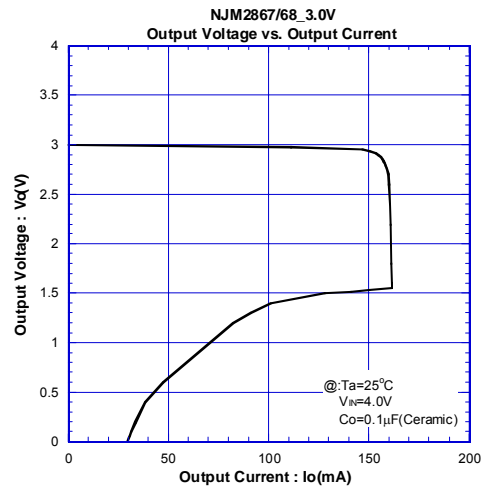
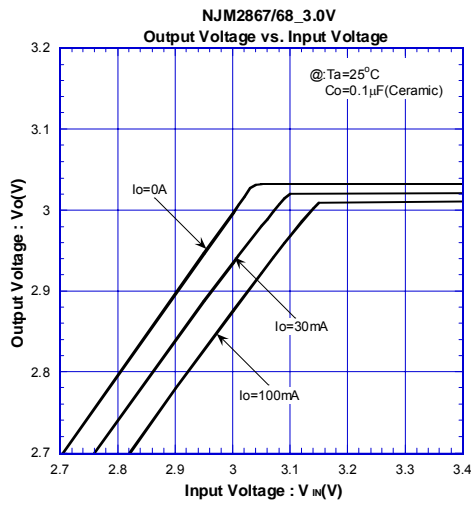

## ELECTRICAL CHARACTERISTICS

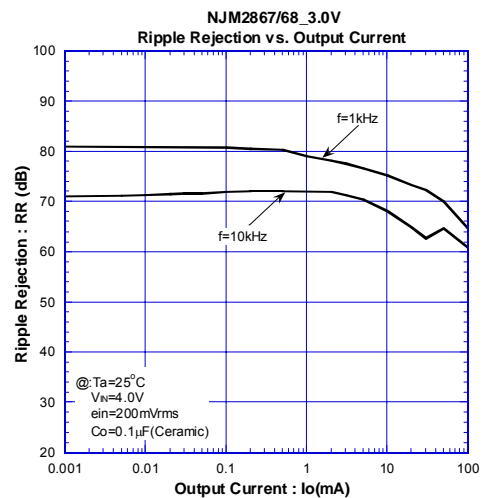
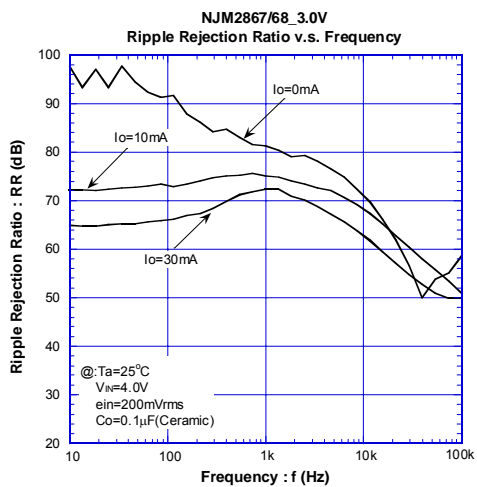
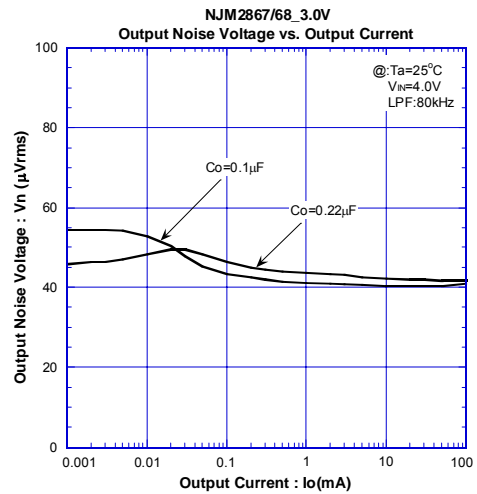
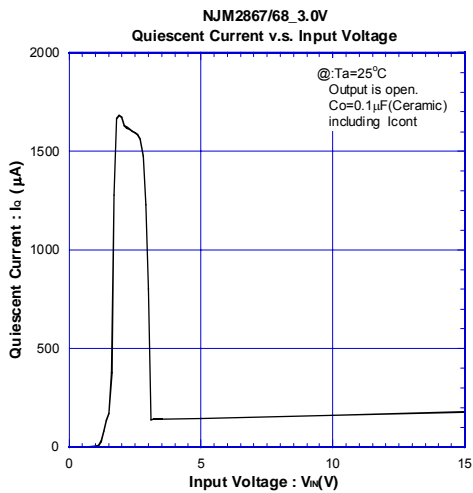
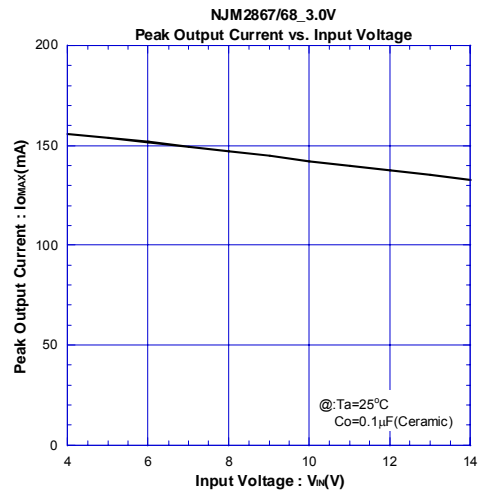
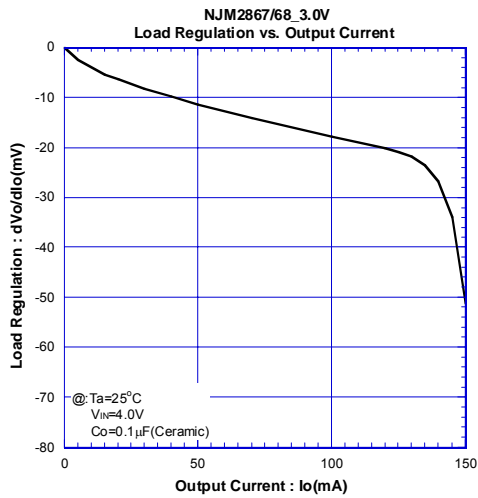

# NJM2867/68

## ELECTRICAL CHARACTERISTICS

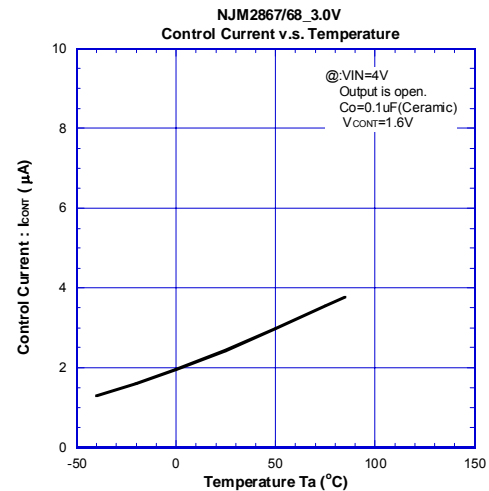
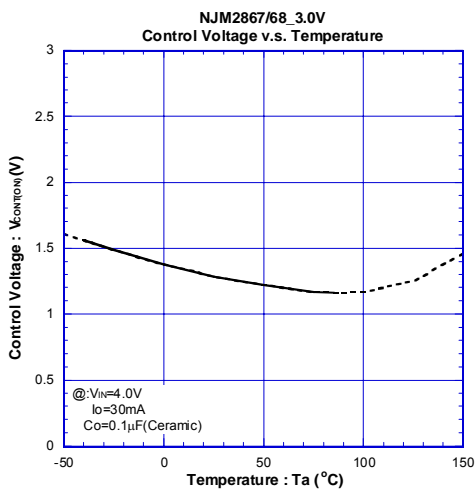
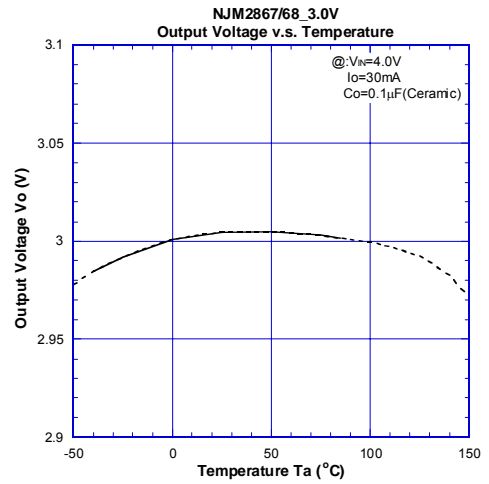
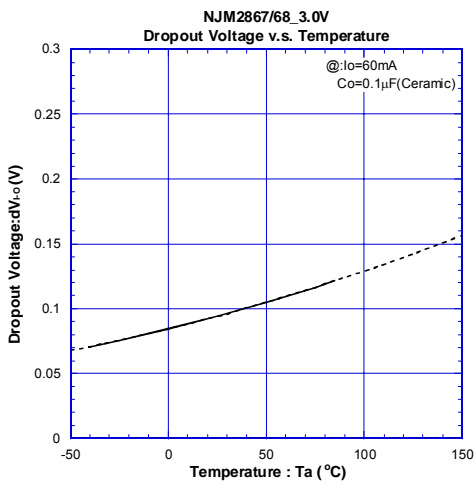
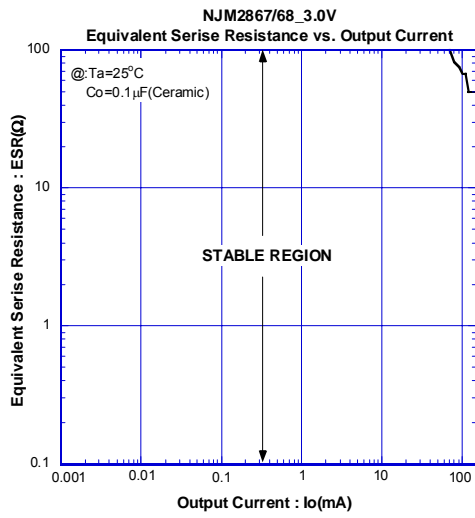



## ■ ELECTRICAL CHARACTERISTICS

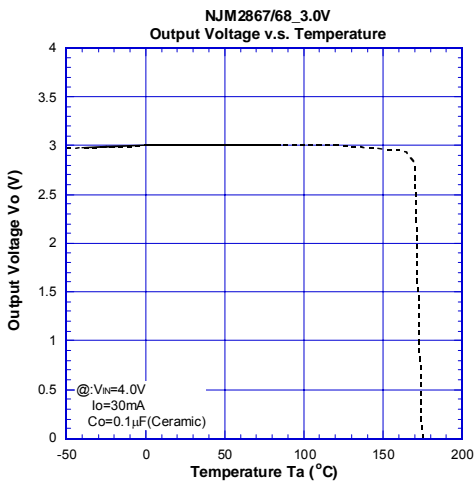
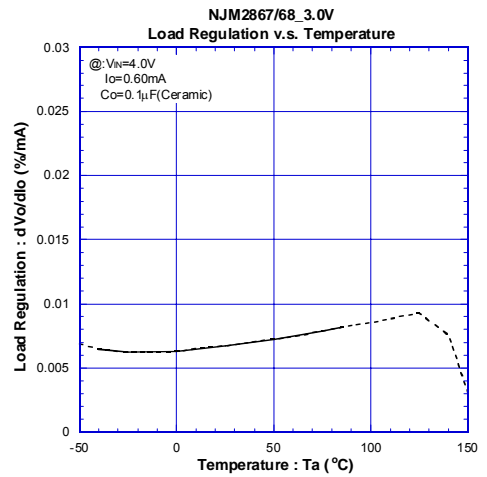
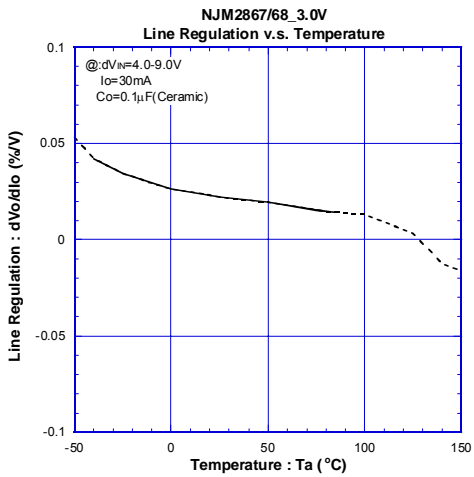
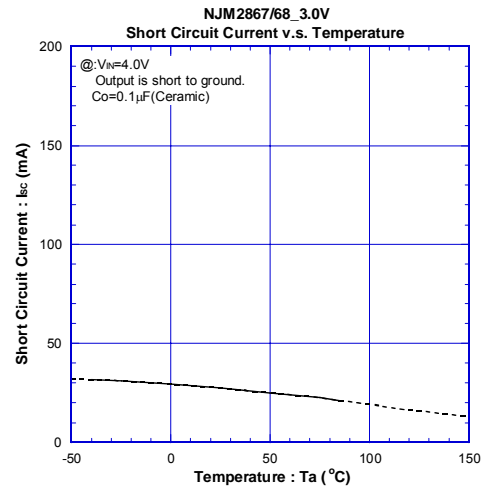
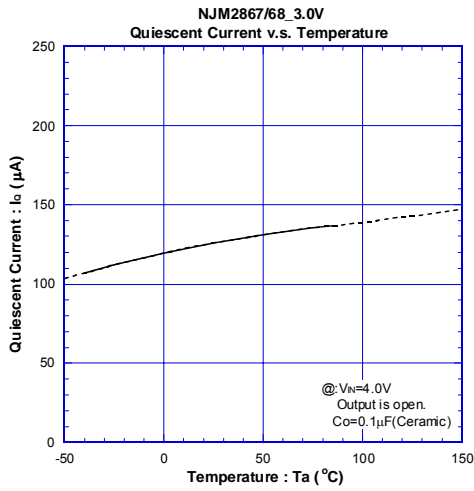

# NJM2867/68

## ELECTRICAL CHARACTERISTICS

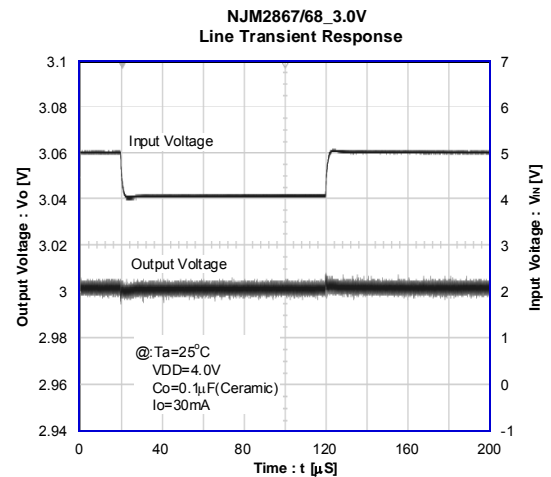
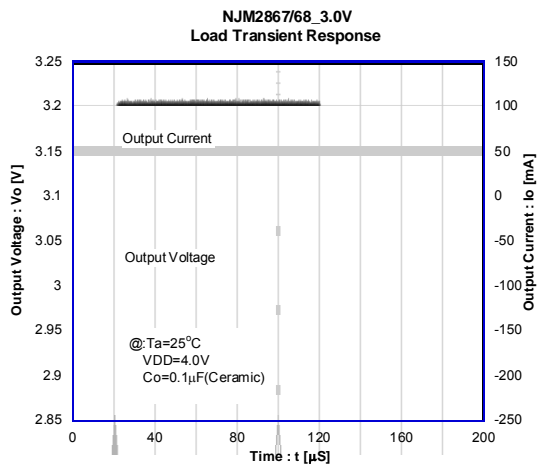
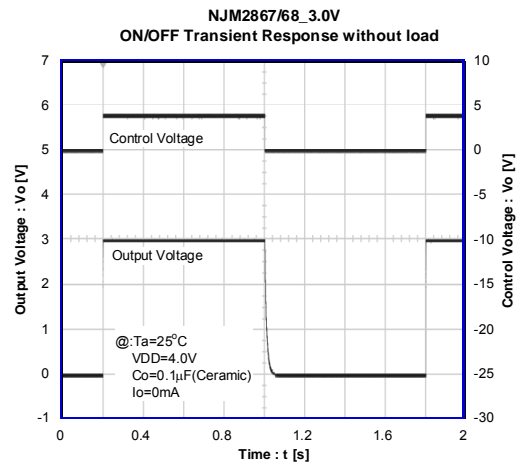
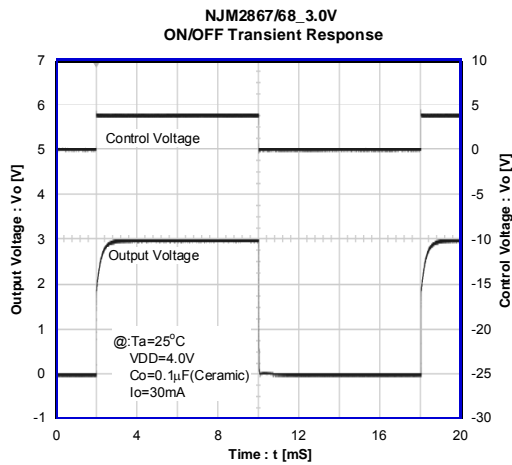

[CAUTION]  
The specifications on this databook are only given for information, without any guarantee as regards either mistakes or omissions. The application circuits in this databook are described only to show representative usages of the product and not intended for the guarantee or permission of any right including the industrial rights.

# Mouser Electronics

Authorized Distributor

Click to View Pricing, Inventory, Delivery & Lifecycle Information:

## [NJR:](#)

[NJM2867F26-TE2](#) [NJM2867F3-29-TE2](#) [NJM2868F28-TE1](#) [NJM2867F3-25-TE1](#) [NJM2867F29-TE2](#) [NJM2867F25-TE2](#) [NJM2867F3-05-TE1](#) [NJM2867F3-34-TE2](#) [NJM2867F3-38-TE2](#) [NJM2868F21-TE1](#) [NJM2868F32-TE1](#) [NJM2868F33-TE1](#) [NJM2867F38-TE2](#) [NJM2868F34-TE1](#) [NJM2868F05-TE1](#) [NJM2867F3-32-TE2](#) [NJM2867F33-TE1](#) [NJM2867F33-TE2](#) [NJM2867F3-26-TE1](#) [NJM2867F34-TE2](#) [NJM2867F3-03-TE1](#) [NJM2867F24-TE1](#) [NJM2867F3-27-TE1](#) [NJM2868F03-TE1](#) [NJM2867F32-TE2](#) [NJM2867F3-33-TE1](#) [NJM2867F05-TE2](#) [NJM2867F21-TE2](#) [NJM2868F05-TE2](#) [NJM2867F3-21-TE2](#) [NJM2868F26-TE1](#) [NJM2867F31-TE2](#) [NJM2867F3-28-TE1](#) [NJM2868F31-TE1](#) [NJM2867F28-TE2](#) [NJM2867F3-24-TE2](#) [NJM2867F03-TE1](#) [NJM2868F25-TE1](#) [NJM2868F24-TE1](#) [NJM2868F38-TE1](#) [NJM2868F29-TE1](#) [NJM2867F3-31-TE2](#) [NJM2867F05-TE1](#)

Компания «Океан Электроники» предлагает заключение долгосрочных отношений при поставках импортных электронных компонентов на взаимовыгодных условиях!

Наши преимущества:

- Поставка оригинальных импортных электронных компонентов напрямую с производств Америки, Европы и Азии, а так же с крупнейших складов мира;
- Широкая линейка поставок активных и пассивных импортных электронных компонентов (более 30 млн. наименований);
- Поставка сложных, дефицитных, либо снятых с производства позиций;
- Оперативные сроки поставки под заказ (от 5 рабочих дней);
- Экспресс доставка в любую точку России;
- Помощь Конструкторского Отдела и консультации квалифицированных инженеров;
- Техническая поддержка проекта, помощь в подборе аналогов, поставка прототипов;
- Поставка электронных компонентов под контролем ВП;
- Система менеджмента качества сертифицирована по Международному стандарту ISO 9001;
- При необходимости вся продукция военного и аэрокосмического назначения проходит испытания и сертификацию в лаборатории (по согласованию с заказчиком);
- Поставка специализированных компонентов военного и аэрокосмического уровня качества (Xilinx, Altera, Analog Devices, Intersil, Interpoint, Microsemi, Actel, Aeroflex, Peregrine, VPT, Syfer, Eurofarad, Texas Instruments, MS Kennedy, Miteq, Cobham, E2V, MA-COM, Hittite, Mini-Circuits, General Dynamics и др.);

Компания «Океан Электроники» является официальным дистрибьютором и эксклюзивным представителем в России одного из крупнейших производителей разъемов военного и аэрокосмического назначения «JONHON», а так же официальным дистрибьютором и эксклюзивным представителем в России производителя высокотехнологичных и надежных решений для передачи СВЧ сигналов «FORSTAR».



## JONHON

«JONHON» (основан в 1970 г.)

Разъемы специального, военного и аэрокосмического назначения:

(Применяются в военной, авиационной, аэрокосмической, морской, железнодорожной, горно- и нефтедобывающей отраслях промышленности)

«FORSTAR» (основан в 1998 г.)

ВЧ соединители, коаксиальные кабели, кабельные сборки и микроволновые компоненты:

(Применяются в телекоммуникациях гражданского и специального назначения, в средствах связи, РЛС, а так же военной, авиационной и аэрокосмической отраслях промышленности).



Телефон: 8 (812) 309-75-97 (многоканальный)

Факс: 8 (812) 320-03-32

Электронная почта: [ocean@oceanchips.ru](mailto:ocean@oceanchips.ru)

Web: <http://oceanchips.ru/>

Адрес: 198099, г. Санкт-Петербург, ул. Калинина, д. 2, корп. 4, лит. А