

ISL21090

Ultra Low Noise, Precision Voltage Reference

FN6993
Rev 5.00
February 27, 2013

The ISL21090 is a ultra low noise, high DC accuracy precision voltage reference with wide input voltage range. The ISL21090 uses the new Intersil Advanced Bipolar technology to achieve sub $1.0\mu\text{V}_{\text{P-P}}$ (1.25V option) 0.1Hz to 10Hz noise with an initial voltage accuracy of 0.02% (2.5V option).

The ISL21090 offers 1.25V, 2.5V, 5.0V and 7.5V output voltage options with 7ppm/°C temperature coefficient and also provides excellent line and load regulation. These devices are offered in an 8 Ld SOIC package.

The ISL21090 is ideal for high-end instrumentation, data acquisition and processing applications requiring high DC precision where low noise performance is critical.

Applications

- High-end instrumentation
- Precision voltage sources for data acquisition system, industrial control, communication infrastructure
- Process control and instrumentations
- Active source for sensors

Features

- Reference output voltage option
 - 1.25V, 2.5V, 5.0V and 7.5V
- Initial accuracy:
 - ISL21090-12 $\pm 0.03\%$
 - ISL21090-25 $\pm 0.02\%$
 - ISL21090-50 $\pm 0.025\%$
 - ISL21090-75 $\pm 0.035\%$
- Output voltage noise (0.1Hz to 10Hz) $1.0\mu\text{V}_{\text{P-P}}$ typ (1.25V option)
- Supply current $750\mu\text{A}$ (1.25V option)
- Temperature coefficient 7ppm/°C max
- Output current capability 20mA
- Line regulation $.6\text{ppm/V}$ (1.25V option)
- Load regulation 2.5ppm/mA (1.25V option)
- Operating temperature range -40°C to $+125^\circ\text{C}$

Related Literature

See [AN1764](#), "ISL21090XXEV1Z User's Guide"

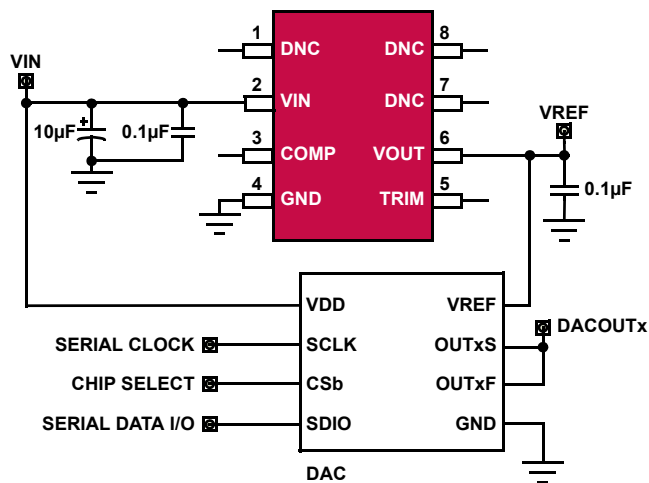

FIGURE 1. ISL21090 TYPICAL APPLICATION DIAGRAM

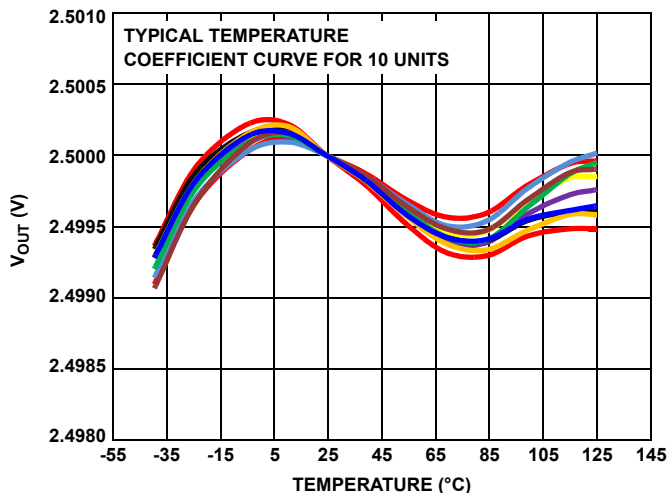
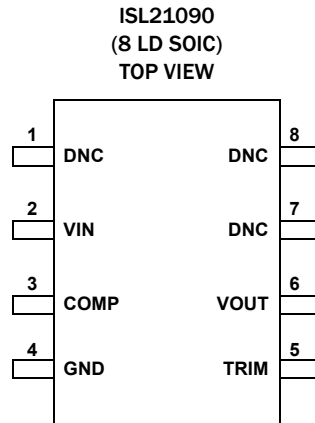

FIGURE 2. V_{OUT} vs TEMPERATURE (2.5V OPTION)

Pin Configuration



Pin Descriptions

| PIN NUMBER | PIN NAME | DESCRIPTION |
|------------|----------|--|
| 1, 7, 8 | DNC | Do Not Connect |
| 2 | VIN | Input Voltage Connection |
| 3 | COMP | Compensation and Noise Reduction Capacitor |
| 4 | GND | Ground Connection |
| 5 | TRIM | Voltage Reference Trim input |
| 6 | VOUT | Voltage Reference Output |

Ordering Information

| PART NUMBER (Notes 1, 2, 3) | PART MARKING | V _{OUT} OPTION (V) | GRADE (%) | TEMPCO (ppm/°C) | TEMP RANGE (°C) | PACKAGE TAPE & REEL (Pb-Free) | PKG. DWG. # |
|--------------------------------|-----------------|--------------------------------|--------------|--------------------|--------------------|-------------------------------------|----------------|
| ISL21090BFB812Z-TK | 21090 BFZ12 | 1.25 | 0.03 | 7 | -40 to +125 | 8 Ld SOIC | M8.15E |
| ISL21090BFB825Z-TK | 21090 BFZ25 | 2.5 | 0.02 | 7 | -40 to +125 | 8 Ld SOIC | M8.15E |
| ISL21090BFB850Z-TK | 21090 BFZ50 | 5.0 | 0.025 | 7 | -40 to +125 | 8 Ld SOIC | M8.15E |
| ISL21090BFB875Z-TK | 21090 BFZ75 | 7.5 | 0.035 | 7 | -40 to +125 | 8 Ld SOIC | M8.15E |

NOTES:

1. Please refer to [TB347](#) for details on reel specifications.
2. These Intersil Pb-free plastic packaged products employ special Pb-free material sets, molding compounds/die attach materials, and 100% matte tin plate plus anneal (e3 termination finish, which is RoHS compliant and compatible with both SnPb and Pb-free soldering operations). Intersil Pb-free products are MSL classified at Pb-free peak reflow temperatures that meet or exceed the Pb-free requirements of IPC/JEDEC J STD-020.
3. For Moisture Sensitivity Level (MSL), please see device information page for [ISL21090B12](#), [ISL21090B25](#), [ISL21090B50](#), [ISL21090B75](#). For more information on MSL please see Tech Brief [TB363](#).

Absolute Maximum Ratings

| | |
|--|--|
| Max Voltage | |
| V_{IN} to GND | -0.5V to +40V |
| V_{OUT} to GND (10s) | -0.5V to $V_{OUT} + 0.5V$ |
| Voltage on any Pin to Ground | -0.5V to $+V_{OUT} + 0.5V$ |
| Voltage on DNC pins | No connections permitted to these pins |
| Input Voltage Slew Rate (Max) | 0.1V/ μ s |
| ESD Ratings | |
| Human Body Model (Tested per JESD22-A114F) | 3kV |
| Machine Model (Tested per JESD22-A115-C) | 200V |
| Charged Device Model (Tested per JESD22-C110D) | 2kV |
| Latch-up (Tested per JESD-78B; Class 2, Level A) | at +125°C |

Thermal Information

| | | |
|---|----------------------|----------------------|
| Thermal Resistance (Typical) | θ_{JA} (°C/W) | θ_{JC} (°C/W) |
| 8 Ld SOIC Package (Notes 4, 5) | 110 | 60 |
| Continuous Power Dissipation ($T_A = +125^\circ\text{C}$) | .217mW | |
| Maximum Junction Temperature (T_{JMAX}) | +150°C | |
| Storage Temperature Range | -65°C to +150°C | |

Recommended Operating Conditions

| | |
|--------------------------------|-----------------|
| Temperature Range (Industrial) | -40°C to +125°C |
|--------------------------------|-----------------|

CAUTION: Do not operate at or near the maximum ratings listed for extended periods of time. Exposure to such conditions may adversely impact product reliability and result in failures not covered by warranty.

NOTES:

- θ_{JA} is measured with the component mounted on a high effective thermal conductivity test board in free air. See Tech Brief [TB379](#) for details.
- For θ_{JC} , the "case temp" location is taken at the package top center.
- Post-reflow drift for the ISL21090 devices can exceed 100 μ V to 1.0mV based on experimental results with devices on FR4 double sided boards. The system engineer must take this into account when considering the reference voltage after assembly.

Electrical Specifications $V_{IN} = 5V$ (1.25V option), $I_{OUT} = 0$, $C_L = 0.1\mu F$ and $C_C = 0.01\mu F$, unless otherwise specified. **Boldface limits apply over the operating temperature range, -40°C to +125°C.**

| PARAMETER | DESCRIPTION | CONDITIONS | MIN (Note 7) | TYP | MAX (Note 7) | UNIT |
|---------------------------------|---|--|-----------------|-------|-----------------|------------------------|
| V_{OUT} | Output Voltage | $V_{IN} = 5V$, | | 1.25 | | V |
| V_{OA} | V_{OUT} Accuracy @ $T_A = +25^\circ\text{C}$ (Note 6) | $V_{OUT} = 1.25V$ | -0.03 | | +0.03 | % |
| TC V_{OUT} | Output Voltage Temperature Coefficient (Note 8) | ISL21090 B grade | | | 7 | ppm/°C |
| V_{IN} | Input Voltage Range | $V_{OUT} = 1.25V$ | 3.7 | | 36 | V |
| I_{IN} | Supply Current | | | 0.750 | 1.28 | mA |
| $\Delta V_{OUT}/\Delta V_{IN}$ | Line Regulation | $V_{IN} = 3.7V$ to 36V, $V_{OUT} = 1.25V$ | | 6 | 17 | ppm/V |
| $\Delta V_{OUT}/\Delta I_{OUT}$ | Load Regulation | Sourcing: $0\text{mA} \leq I_{OUT} \leq 20\text{mA}$ | | 2.5 | 17 | ppm/mA |
| V_D | Dropout Voltage (Note 9) | $V_{OUT} = 1.25V$ @ 10mA | | 1.7 | 2.15 | V |
| I_{SC+} | Short Circuit Current | $T_A = +25^\circ\text{C}$, V_{OUT} tied to GND | | 53 | | mA |
| t_R | Turn-on Settling Time | 90% of final value, $C_L = 1.0\mu F$, $C_C = \text{open}$ | | 150 | | μ s |
| | Ripple Rejection | $f = 120\text{Hz}$ | | 90 | | dB |
| e_{n-p-p} | Voltage Noise | $0.1\text{Hz} \leq f \leq 10\text{Hz}$, $V_{OUT} = 1.25V$ | | 1.0 | | μ V _{P-P} |
| V_n | Broadband Voltage Noise | $10\text{Hz} \leq f \leq 1\text{kHz}$, $V_{OUT} = 1.25V$ | | 1.2 | | μ V _{RMS} |
| e_n | Noise Voltage Density | $f = 1\text{kHz}$, $V_{OUT} = 1.25V$ | | 25 | | nV/ $\sqrt{\text{Hz}}$ |
| $\Delta V_{OUT}/\Delta t$ | Long Term Stability | $T_A = +25^\circ\text{C}$ | | 20 | | ppm |

Electrical Specifications $V_{IN} = 5V$ (2.5V option), $I_{OUT} = 0$ unless otherwise specified. **Boldface limits apply over the operating temperature range, -40°C to +125°C.**

| PARAMETER | DESCRIPTION | CONDITIONS | MIN (Note 7) | TYP | MAX (Note 7) | UNIT |
|---------------------------------|--|---|-----------------|-------|-----------------|-----------------|
| V_{OUT} | Output Voltage | $V_{IN} = 5V$ | | 2.5 | | V |
| V_{OA} | V_{OUT} Accuracy @ $T_A = +25^\circ C$ | All V_{OUT} options | -0.02 | | +0.02 | % |
| TC V_{OUT} | Output Voltage Temperature Coefficient | ISL21090 B grade | | | 7 | ppm/ $^\circ C$ |
| V_{IN} | Input Voltage Range | $V_{OUT} = 2.5V$ | 3.7 | | 36 | V |
| I_{IN} | Supply Current | | | 0.930 | 1.28 | mA |
| $\Delta V_{OUT}/\Delta V_{IN}$ | Line Regulation | $V_{IN} = 3.7V$ to $36V$, $V_{OUT} = 2.5V$ | | 8 | 18 | ppm/V |
| $\Delta V_{OUT}/\Delta I_{OUT}$ | Load Regulation | Sourcing: $0mA \leq I_{OUT} \leq 20mA$ | | 2.5 | 17 | ppm/mA |
| | | Sinking: $-10mA \leq I_{OUT} \leq 0mA$ | | 2.5 | 17 | ppm/mA |
| V_D | Dropout Voltage (Note 9) | $V_{OUT} = 2.5V @ 10mA$ | | 1.1 | 1.7 | V |
| I_{SC+} | Short Circuit Current | $T_A = +25^\circ C$, V_{OUT} tied to GND | | 55 | | mA |
| I_{SC-} | Short Circuit Current | $T_A = +25^\circ C$, V_{OUT} tied to V_{IN} | | -61 | | mA |
| t_R | Turn-on Settling Time | 90% of final value, $C_L = 1.0\mu F$, $C_C = open$ | | 150 | | μs |
| | Ripple Rejection | $f = 120Hz$ | | 90 | | dB |
| e_{np-p} | Noise Voltage | $0.1Hz \leq f \leq 10Hz$, $V_{OUT} = 2.5V$ | | 1.9 | | μV_{p-p} |
| V_n | Broadband Voltage Noise | $10Hz \leq f \leq 1kHz$, $V_{OUT} = 2.5V$ | | 1.6 | | μV_{RMS} |
| e_n | Noise Voltage Density | $f = 1kHz$, $V_{OUT} = 2.5V$ | | 50 | | nV/ \sqrt{Hz} |
| $\Delta V_{OUT}/\Delta t$ | Long Term Stability | $T_A = +25^\circ C$ | | 20 | | ppm |

Electrical Specifications $V_{IN} = 10V$ (5.0V option), $I_{OUT} = 0$ unless otherwise specified. **Boldface limits apply over the operating temperature range, -40°C to +125°C.**

| PARAMETER | DESCRIPTION | CONDITIONS | MIN (Note 7) | TYP | MAX (Note 7) | UNIT |
|---------------------------------|---|---|-----------------|-------|-----------------|-----------------|
| V_{OUT} | Output Voltage | $V_{IN} = 10V$, | | 5.0 | | V |
| V_{OA} | V_{OUT} Accuracy @ $T_A = +25^\circ C$ (Note 6) | $V_{OUT} = 5.0V$ | 0.025 | | 0.025 | % |
| TC V_{OUT} | Output Voltage Temperature Coefficient (Note 8) | ISL21090 B grade | | | 7 | ppm/ $^\circ C$ |
| V_{IN} | Input Voltage Range | $V_{OUT} = 5.0V$ | 7 | | 36 | V |
| I_{IN} | Supply Current | | | 0.930 | 1.33 | mA |
| $\Delta V_{OUT}/\Delta V_{IN}$ | Line Regulation | $V_{IN} = 7V$ to $36V$, $V_{OUT} = 5.0V$ | | 8 | 18 | ppm/V |
| $\Delta V_{OUT}/\Delta I_{OUT}$ | Load Regulation | Sourcing: $0mA \leq I_{OUT} \leq 20mA$ | | 2.5 | 17 | ppm/mA |
| | | Sinking: $-10mA \leq I_{OUT} \leq 0mA$ | | 2.5 | 17 | ppm/mA |
| V_D | Dropout Voltage (Note 9) | $V_{OUT} = 5.0V @ 10mA$ | | 1.1 | 1.7 | V |
| I_{SC+} | Short Circuit Current | $T_A = +25^\circ C$, V_{OUT} tied to GND | | 61 | | mA |
| I_{SC-} | Short Circuit Current | $T_A = +25^\circ C$, V_{OUT} tied to V_{IN} | | -75 | | mA |
| t_R | Turn-on Settling Time | 90% of final value, $C_L = 1.0\mu F$, $C_C = open$ | | 150 | | μs |
| | Ripple Rejection | $f = 120Hz$ | | 90 | | dB |
| e_{np-p} | Output Voltage Noise | $0.1Hz \leq f \leq 10Hz$, $V_{OUT} = 5.0V$ | | 4.2 | | μV_{p-p} |
| V_n | Broadband Voltage Noise | $10Hz \leq f \leq 1kHz$, $V_{OUT} = 5.0V$ | | 3.2 | | μV_{RMS} |
| e_n | Noise Voltage Density | $f = 1kHz$, $V_{OUT} = 5.0V$ | | 100 | | nV/ \sqrt{Hz} |
| $\Delta V_{OUT}/\Delta t$ | Long Term Stability | $T_A = +25^\circ C$ | | 20 | | ppm |

Electrical Specifications $V_{IN} = 15V$ (7.5V option), $I_{OUT} = 0$ unless otherwise specified. **Boldface limits apply over the operating temperature range, -40°C to +125°C.**

| PARAMETER | DESCRIPTION | CONDITIONS | MIN (Note 7) | TYP | MAX (Note 7) | UNIT |
|---------------------------------|---|---|-----------------|-------|-----------------|-----------------|
| V_{OUT} | Output Voltage | $V_{IN} = 15V$, | | 7.5 | | V |
| V_{OA} | V_{OUT} Accuracy @ $T_A = +25^\circ C$ (Note 6) | $V_{OUT} = 7.5V$ | 0.035 | | 0.035 | % |
| TC V_{OUT} | Output Voltage Temperature Coefficient (Note 8) | ISL21090 B grade | | | 7 | ppm/ $^\circ C$ |
| V_{IN} | Input Voltage Range | $V_{OUT} = 7.5V$ | 9 | | 36 | V |
| I_{IN} | Supply Current | | | 0.940 | 1.30 | mA |
| $\Delta V_{OUT}/\Delta V_{IN}$ | Line Regulation | $V_{IN} = 9V$ to $36V$, $V_{OUT} = 7.5V$ | | 2.3 | 18 | ppm/V |
| $\Delta V_{OUT}/\Delta I_{OUT}$ | Load Regulation | Sourcing: $0mA \leq I_{OUT} \leq 20mA$ | | 2.5 | 17 | ppm/mA |
| | | Sinking: $-10mA \leq I_{OUT} \leq 0mA$ | | 9 | 17 | ppm/mA |
| V_D | Dropout Voltage (Note 9) | $V_{OUT} = 7.5V @ 10mA$ | | 1.06 | 1.8 | V |
| I_{SC+} | Short Circuit Current | $T_A = +25^\circ C$, V_{OUT} tied to GND | | 56 | | mA |
| I_{SC-} | Short Circuit Current | $T_A = +25^\circ C$, V_{OUT} tied to V_{IN} | | -69 | | mA |
| t_R | Turn-on Settling Time | 90% of final value, $C_L = 1.0\mu F$, $C_C = open$ | | 150 | | μs |
| | Ripple Rejection | $f = 120Hz$ | | 90 | | dB |
| e_{np-p} | Output Voltage Noise | $0.1Hz \leq f \leq 10Hz$, $V_{OUT} = 7.5V$ | | 6.2 | | μV_{P-P} |
| V_n | Broadband Voltage Noise | $10Hz \leq f \leq 1kHz$, $V_{OUT} = 7.5V$ | | 4.8 | | μV_{RMS} |
| e_n | Noise Voltage Density | $f = 1kHz$, $V_{OUT} = 7.5V$ | | 150 | | nV/ \sqrt{Hz} |
| $\Delta V_{OUT}/\Delta t$ | Long Term Stability | $T_A = +25^\circ C$ | | 20 | | ppm |

NOTES:

- Compliance to datasheet limits is assured by one or more methods: production test, characterization and/or design.
- Over the specified temperature range. Temperature coefficient is measured by the box method whereby the change in V_{OUT} is divided by the temperature range; in this case, $-40^\circ C$ to $+125^\circ C = +165^\circ C$.
- Dropout Voltage is the minimum $V_{IN} - V_{OUT}$ differential voltage measured at the point where V_{OUT} drops 1mV from $V_{IN} = nominal$ at $T_A = +25^\circ C$.

Typical Performance Curves (ISL21090-1.25V)

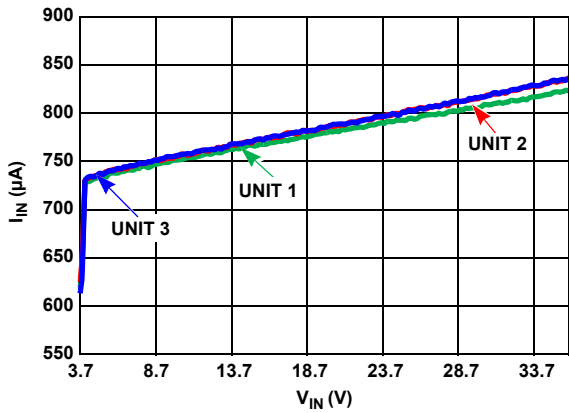

FIGURE 3. I_{IN} vs V_{IN} , THREE UNITS

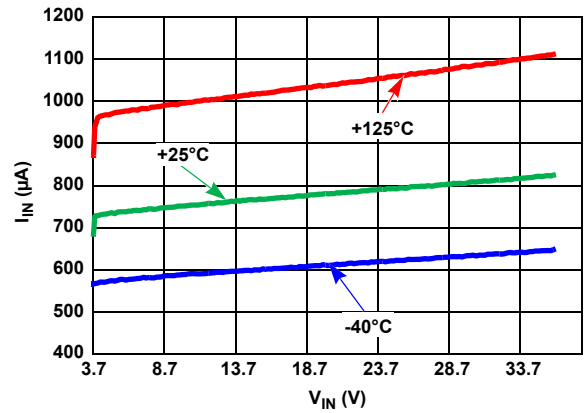

FIGURE 4. I_{IN} vs V_{IN} , THREE TEMPERATURES

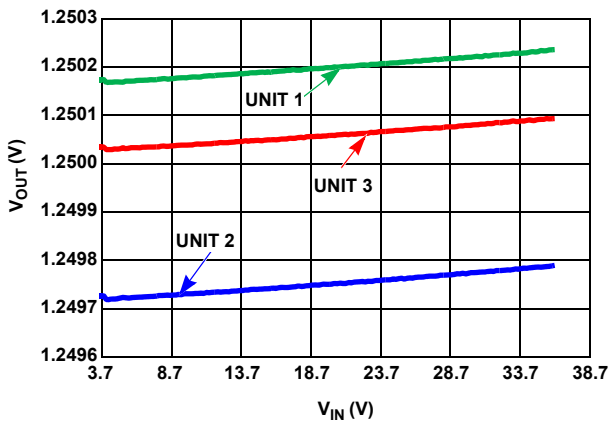

FIGURE 5. LINE REGULATION, THREE UNITS

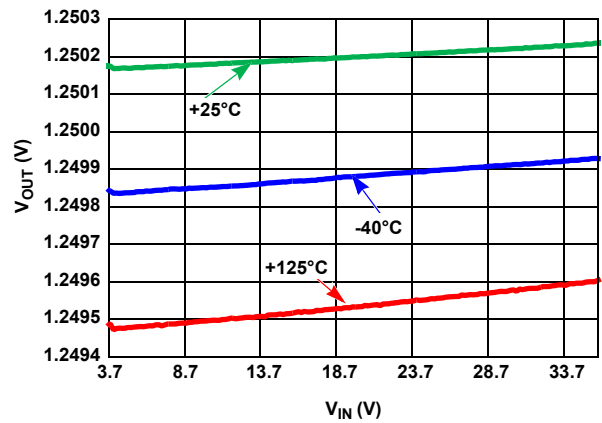

FIGURE 6. LINE REGULATION, THREE TEMPERATURES

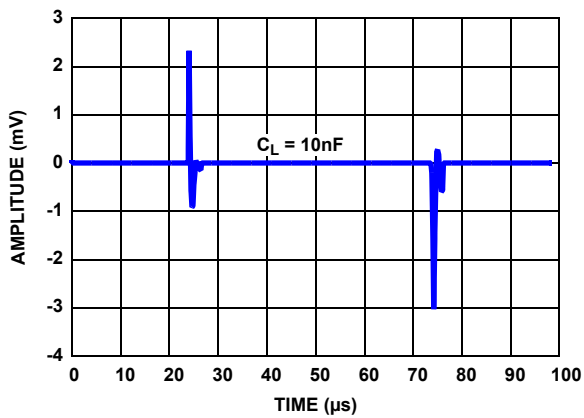

FIGURE 7. LINE TRANSIENT WITH 10nF LOAD ($\Delta V_{IN} = \pm 500\text{mV}$)

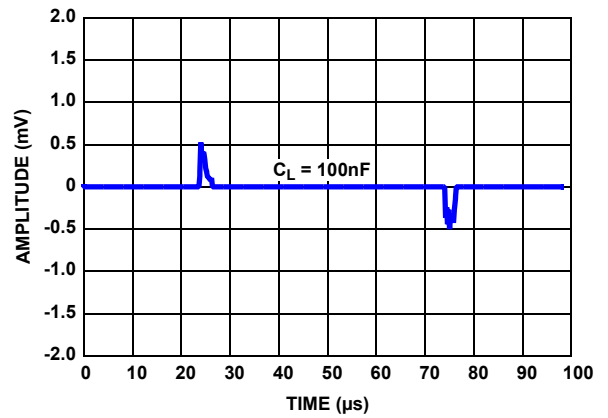

FIGURE 8. LINE TRANSIENT WITH 100nF LOAD ($\Delta V_{IN} = \pm 500\text{mV}$)

Typical Performance Curves (ISL21090-1.25V) (Continued)

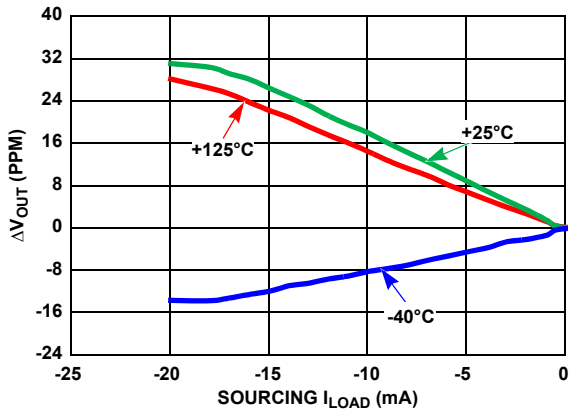

FIGURE 9. LOAD REGULATION, THREE TEMPERATURE

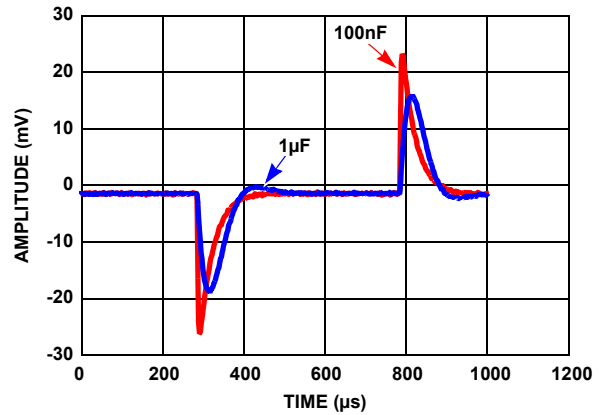

FIGURE 10. LOAD TRANSIENT ($\Delta I_{LOAD} = \pm 1mA$)

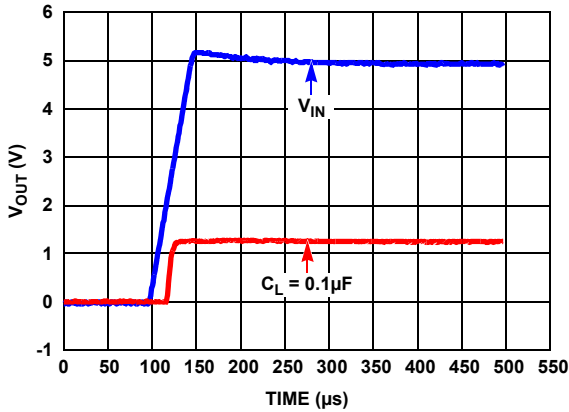

FIGURE 11. TURN ON TIME WITH 0.1μF

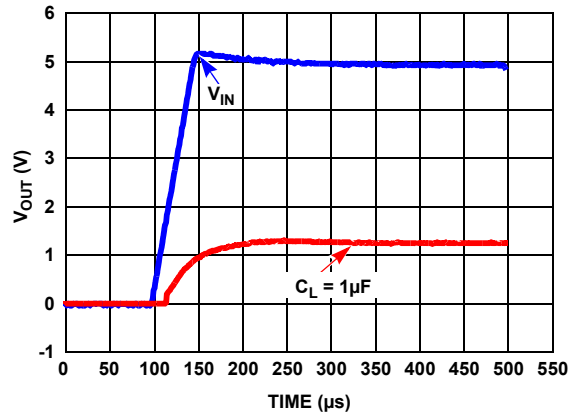

FIGURE 12. TURN ON TIME WITH 1μF

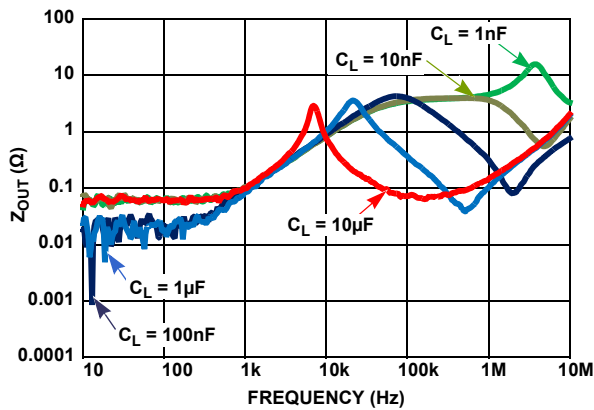

FIGURE 13. Z_{OUT} vs FREQUENCY (COMP = 0.01μF)

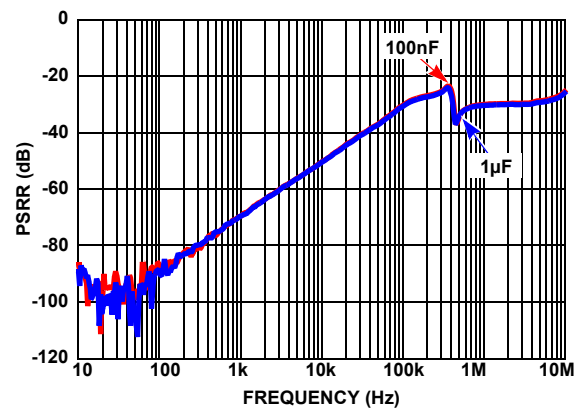

FIGURE 14. PSRR AT DIFFERENT CAPACITIVE LOADS

Typical Performance Curves (ISL21090-1.25V) (Continued)

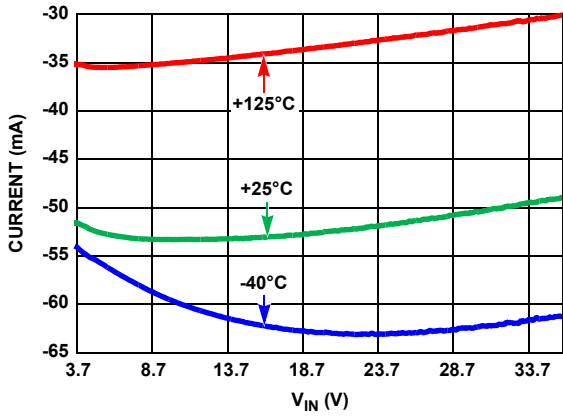

FIGURE 15. SHORT CIRCUIT TO GND

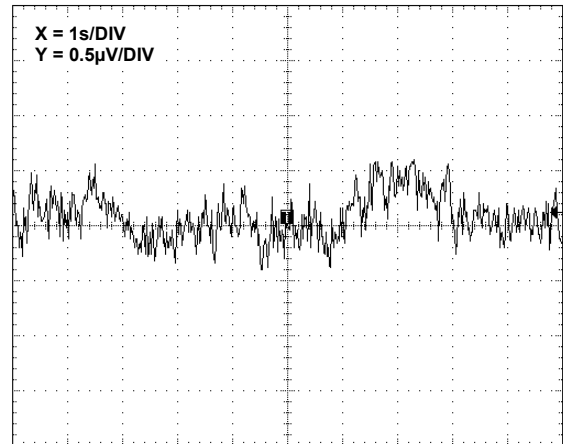

FIGURE 16. V_{OUT} vs NOISE, 0.1Hz TO 10Hz

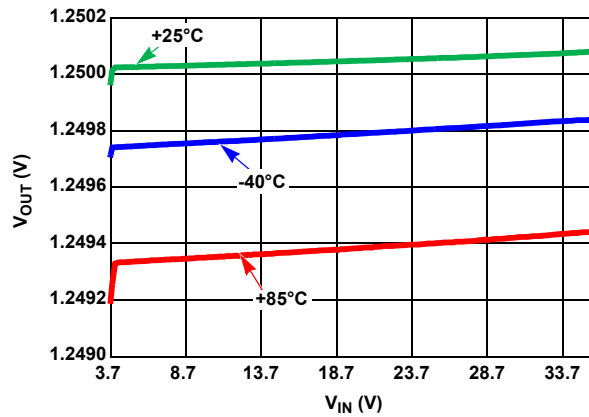

FIGURE 17. DROPOUT WITH -10mA LOAD

Typical Performance Curves (ISL21090-2.5)

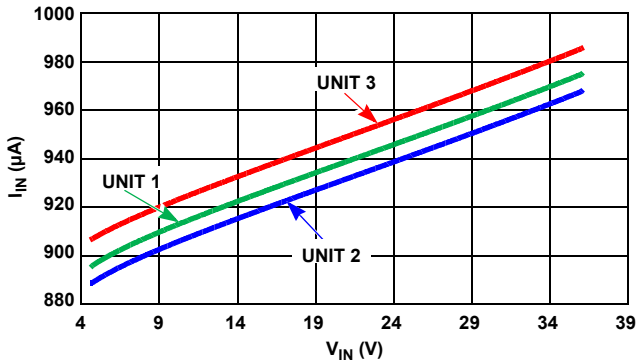

FIGURE 18. I_{IN} vs V_{IN} , THREE UNITS

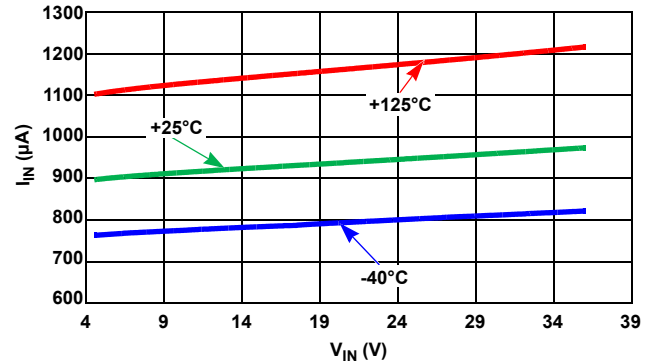

FIGURE 19. I_{IN} vs V_{IN} , THREE TEMPERATURES

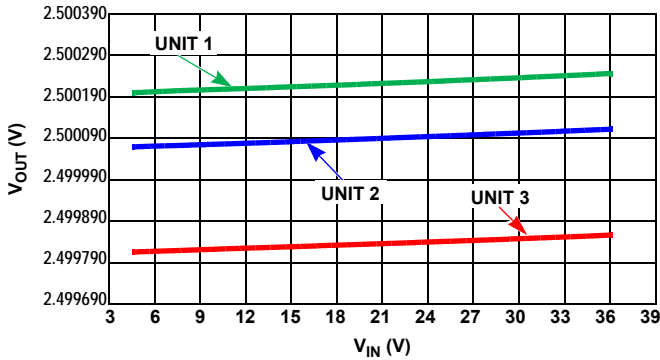

FIGURE 20. LINE REGULATION, THREE UNITS

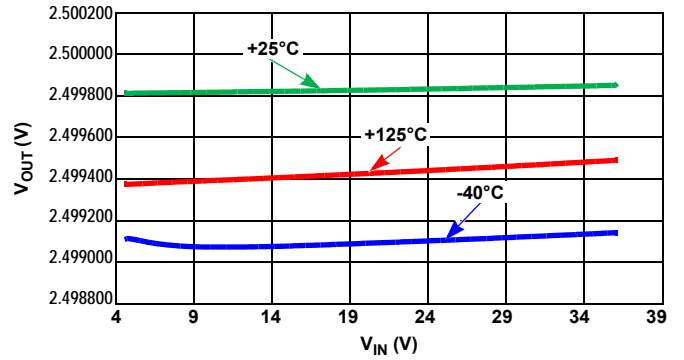

FIGURE 21. LINE REGULATION, THREE TEMPERATURES

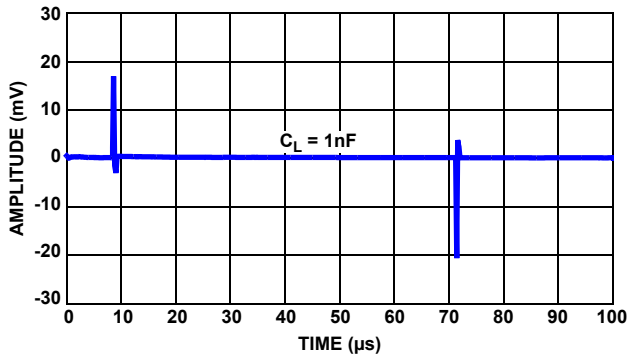

FIGURE 22. LINE TRANSIENT WITH 1nF LOAD ($\Delta V_{IN} = \pm 500\text{mV}$)

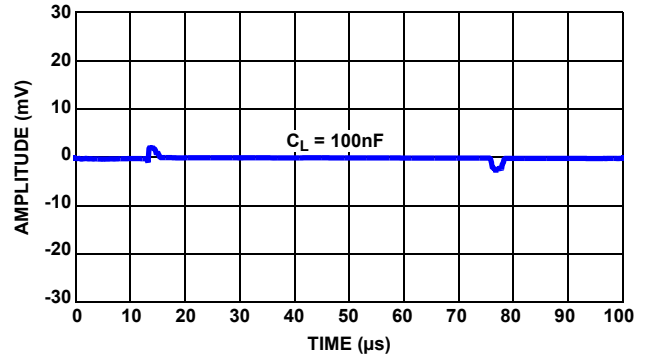

FIGURE 23. LINE TRANSIENT WITH 100nF LOAD ($\Delta V_{IN} = \pm 500\text{mV}$)

Typical Performance Curves (ISL21090-2.5) (Continued)

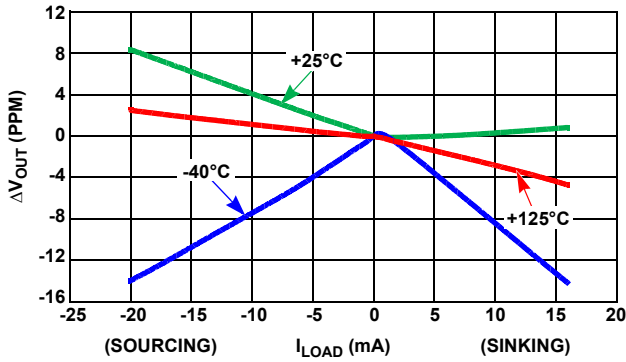

FIGURE 24. LOAD REGULATION, THREE TEMPERATURES

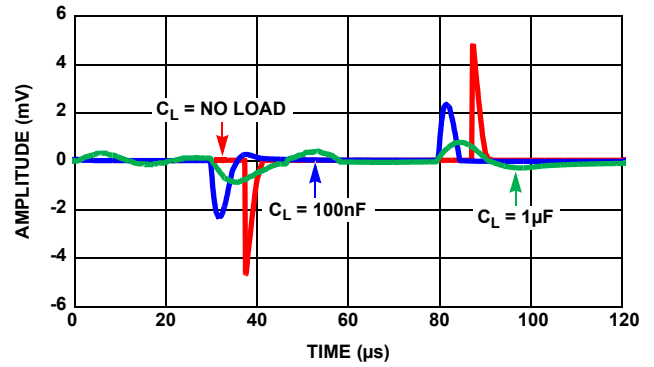

FIGURE 25. LOAD TRANSIENT ($\Delta I_{LOAD} = \pm 1\text{mA}$)

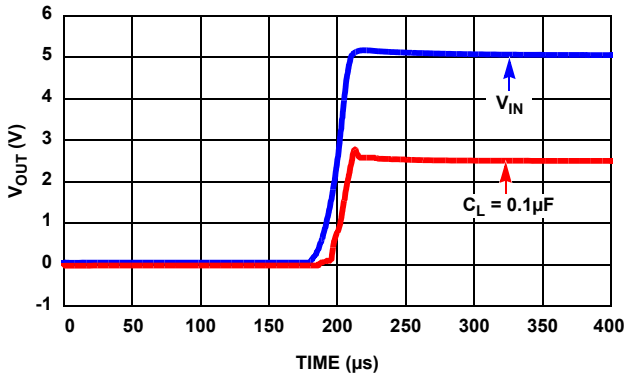

FIGURE 26. TURN-ON TIME WITH 0.1μF

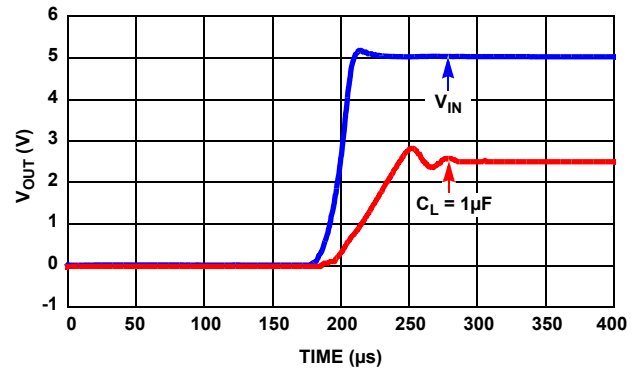

FIGURE 27. TURN-ON TIME WITH 1μF

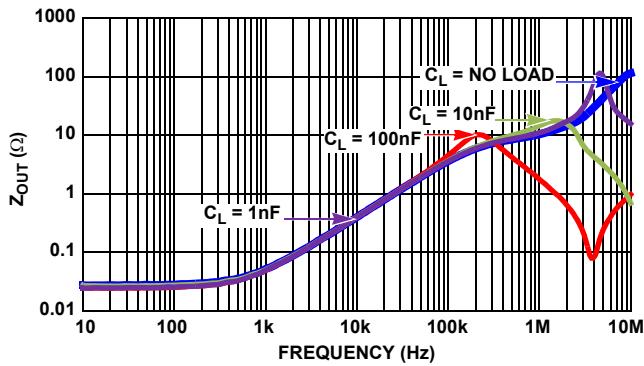

FIGURE 28. Z_{OUT} vs FREQUENCY

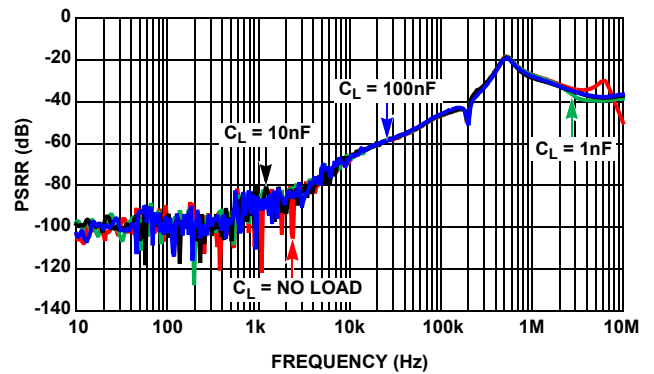

FIGURE 29. PSRR AT DIFFERENT CAPACITIVE LOADS

Typical Performance Curves (ISL21090-2.5) (Continued)

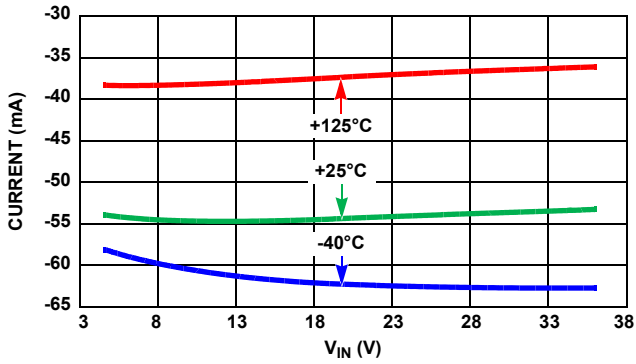

FIGURE 30. SHORT-CIRCUIT TO GND

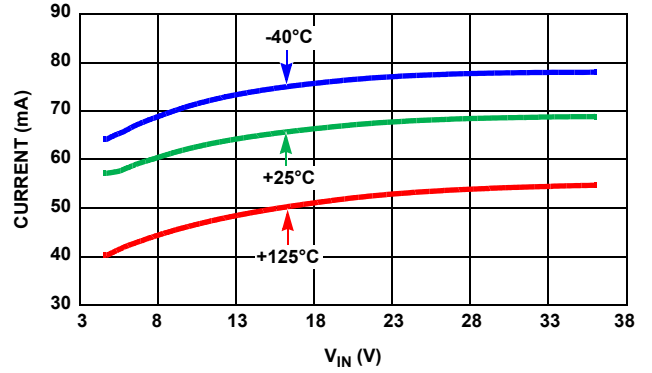

FIGURE 31. SHORT-CIRCUIT TO VIN

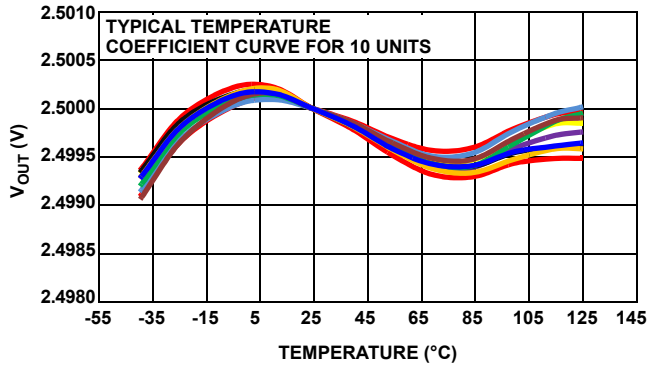

FIGURE 32. VOUT vs TEMPERATURE, 10 UNITS

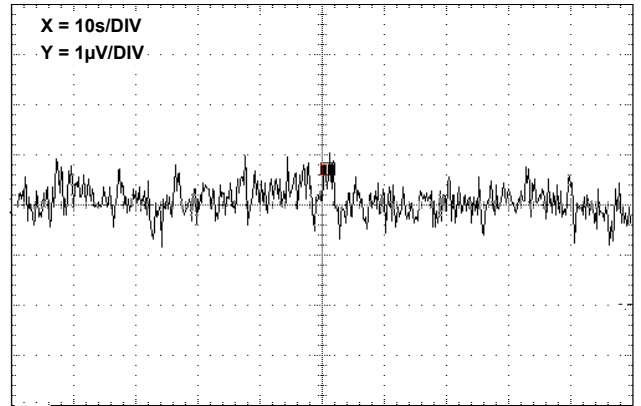

FIGURE 33. VOUT vs NOISE, 0.1Hz TO 10Hz

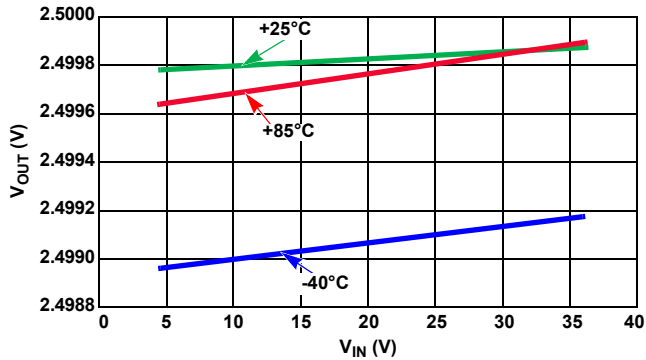

FIGURE 34. DROPOUT WITH -10mA LOAD

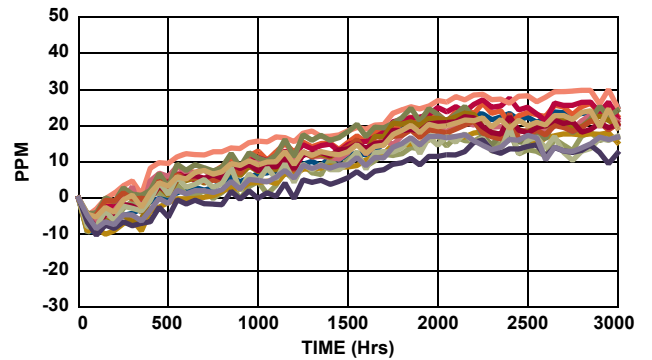

FIGURE 35. LONG TERM STABILITY

Typical Performance Curves (ISL21090-5.0)

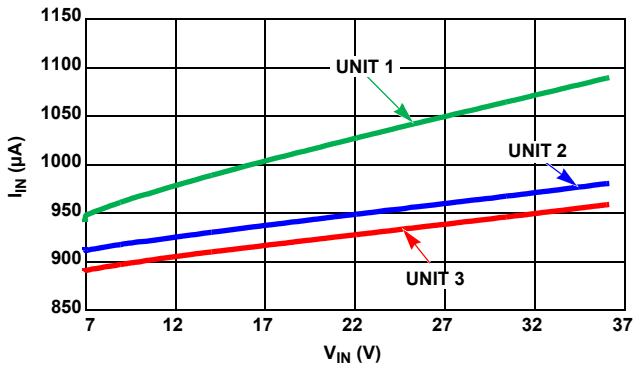

FIGURE 36. I_{IN} vs V_{IN}, THREE UNITS

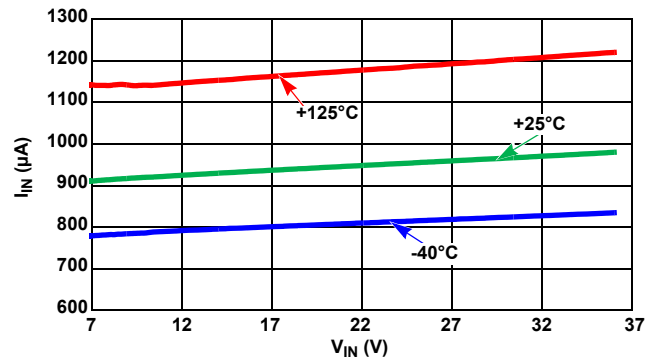

FIGURE 37. I_{IN} vs V_{IN}, THREE TEMPERATURES

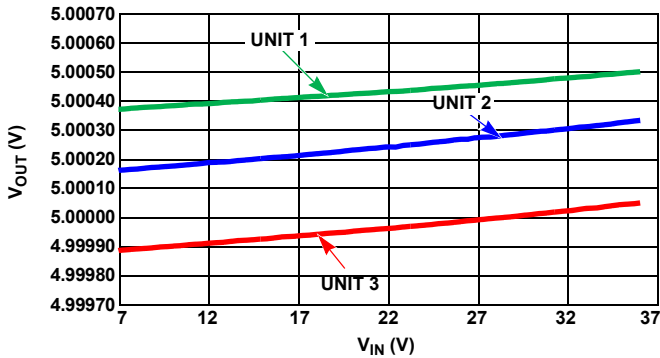

FIGURE 38. LINE REGULATION, THREE UNITS

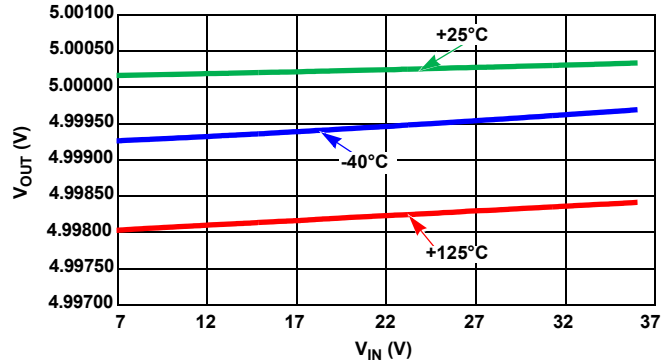

FIGURE 39. LINE REGULATION, THREE TEMPERATURES

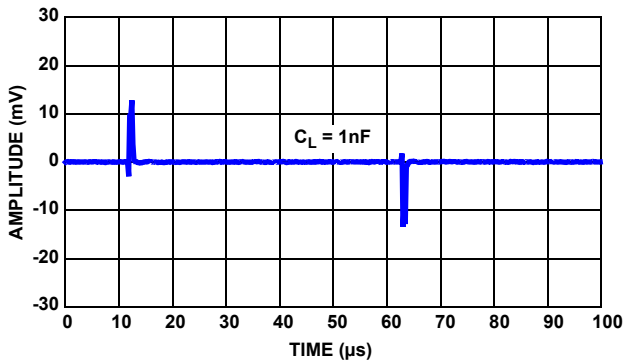

FIGURE 40. LINE TRANSIENT WITH 1nF LOAD ($\Delta V_{IN} = \pm 500\text{mV}$)

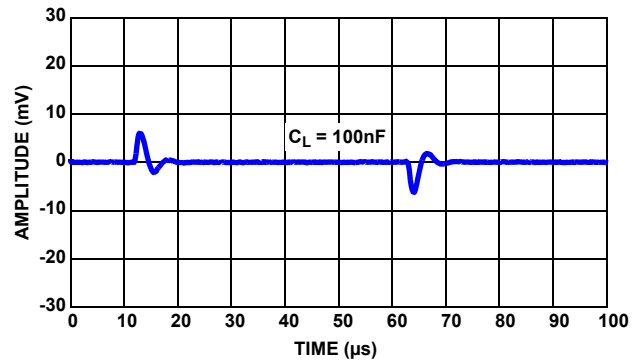

FIGURE 41. LINE TRANSIENT WITH 100nF LOAD ($\Delta V_{IN} = \pm 500\text{mV}$)

Typical Performance Curves (ISL21090-5.0) (Continued)

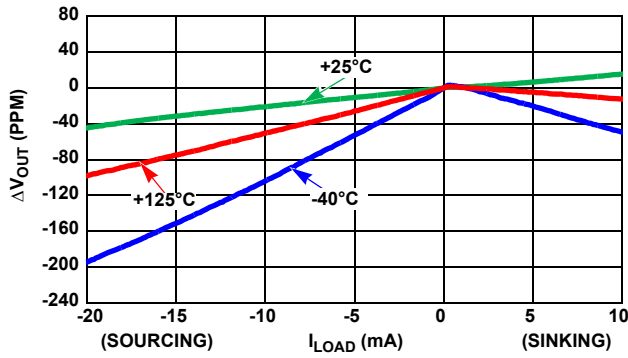

FIGURE 42. LOAD REGULATION, THREE TEMPERATURES

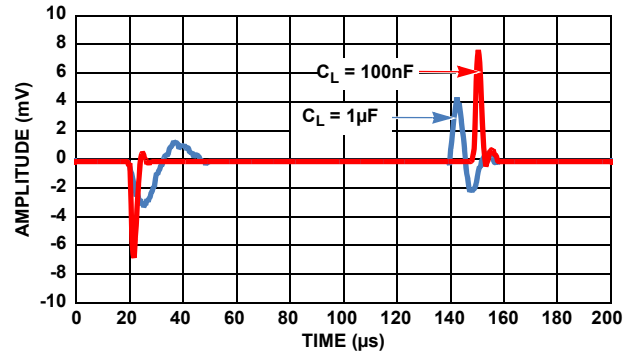

FIGURE 43. LOAD TRANSIENT (ΔILOAD = ±1mA)

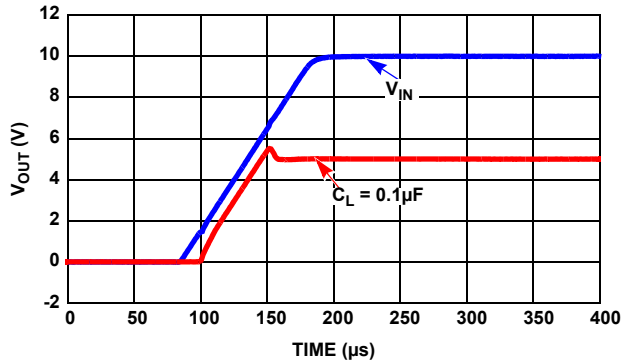

FIGURE 44. TURN-ON TIME WITH 0.1μF

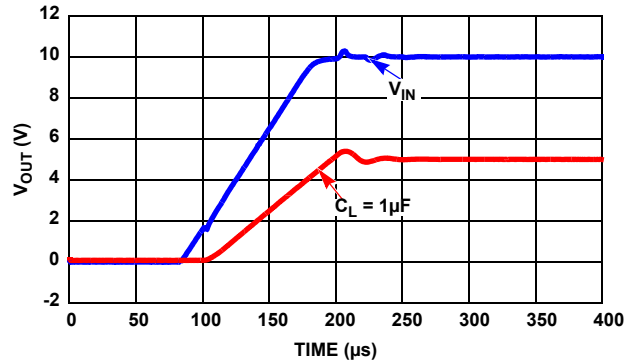

FIGURE 45. TURN-ON TIME WITH 1μF

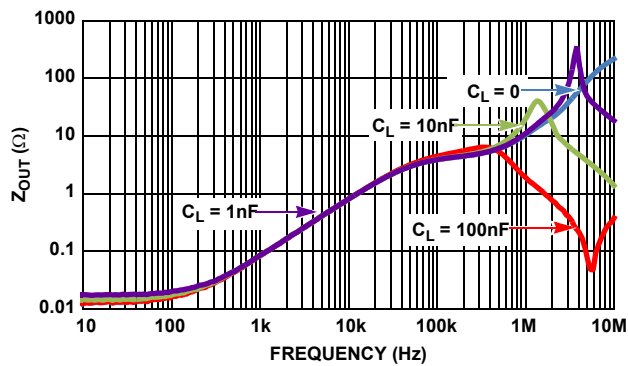

FIGURE 46. ZOUT vs FREQUENCY

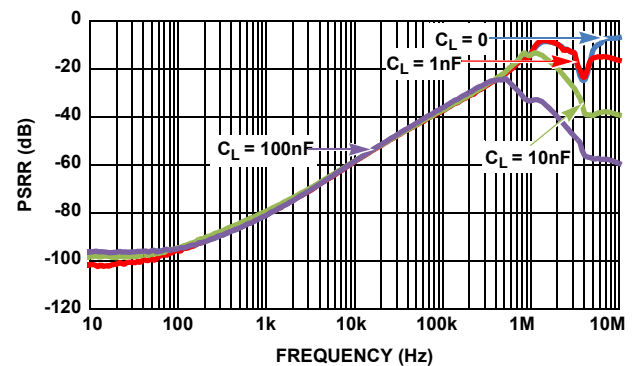

FIGURE 47. PSRR AT DIFFERENT CAPACITIVE LOADS

Typical Performance Curves (ISL21090-5.0) (Continued)

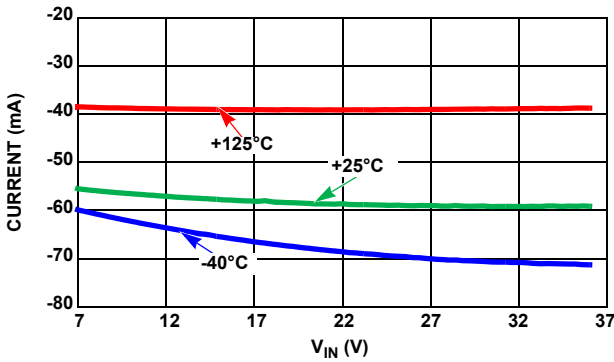

FIGURE 48. SHORT-CIRCUIT TO GND

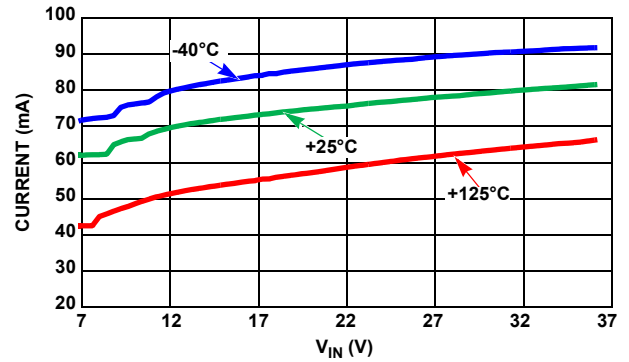

FIGURE 49. SHORT-CIRCUIT TO VIN

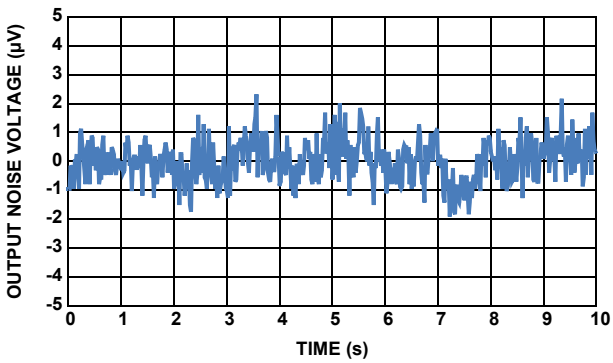

FIGURE 50. V_{OUT} vs NOISE, 0.1Hz TO 10Hz

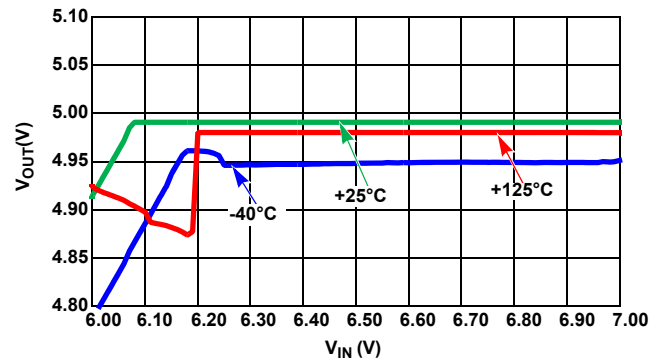

FIGURE 51. DROPOUT WITH -10mA LOAD

Typical Performance Curves (ISL21090-7.5)

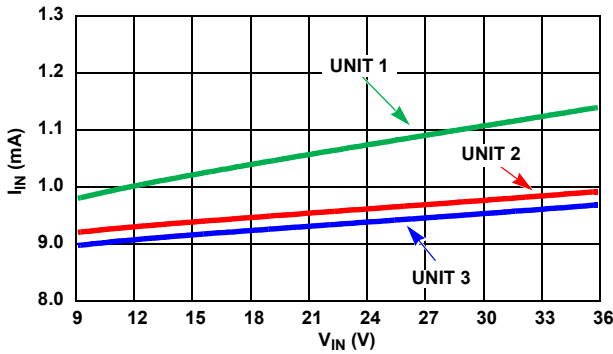

FIGURE 52. I_{IN} vs V_{IN} , THREE UNITS

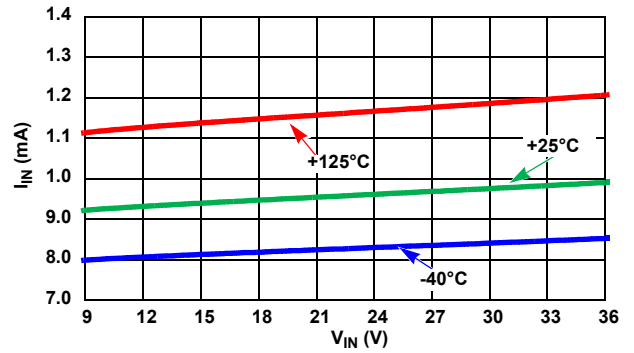

FIGURE 53. I_{IN} vs V_{IN} , THREE TEMPERATURES

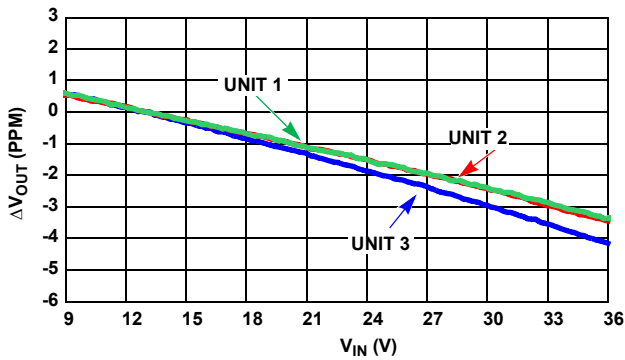

FIGURE 54. LINE REGULATION, THREE UNITS

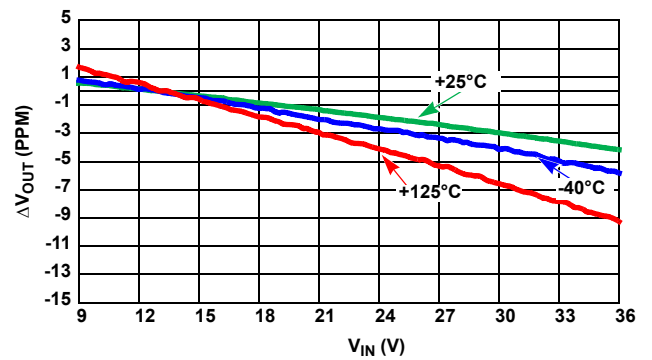

FIGURE 55. LINE REGULATION, THREE TEMPERATURES

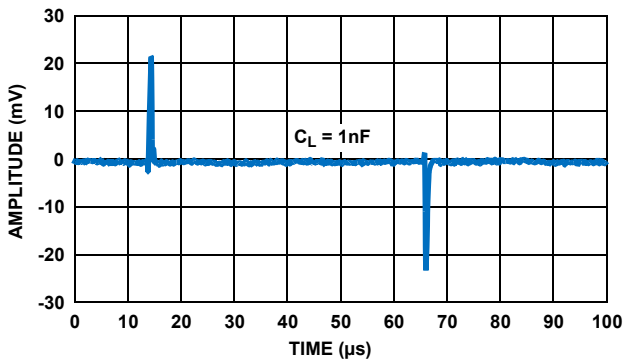

FIGURE 56. LINE TRANSIENT WITH 1nF LOAD ($\Delta V_{IN} = \pm 500mV$)

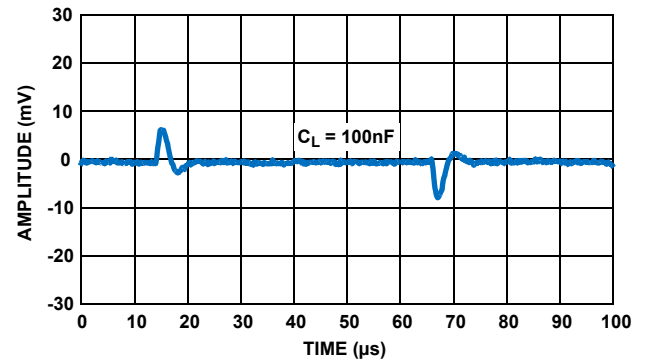

FIGURE 57. LINE TRANSIENT WITH 100nF LOAD ($\Delta V_{IN} = \pm 500mV$)

Typical Performance Curves (ISL21090-7.5) (Continued)

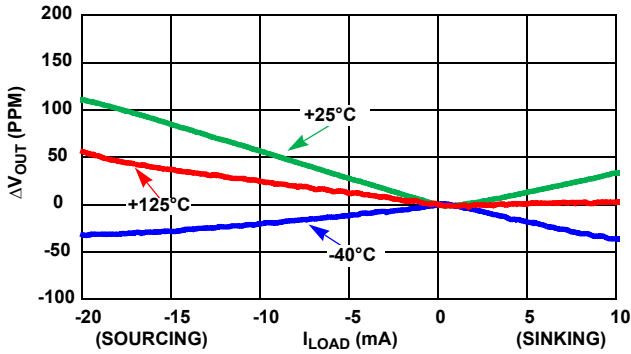

FIGURE 58. LOAD REGULATION, THREE TEMPERATURES

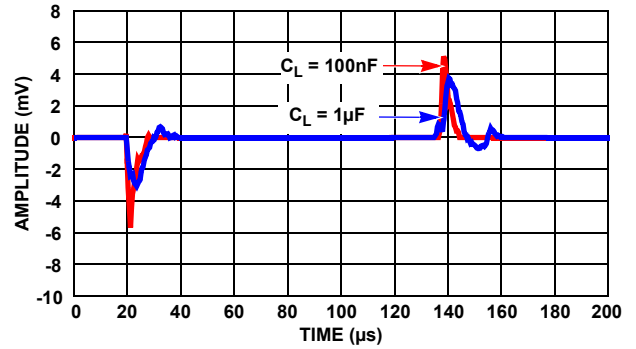

FIGURE 59. LOAD TRANSIENT ($\Delta I_{LOAD} = \pm 1mA$)

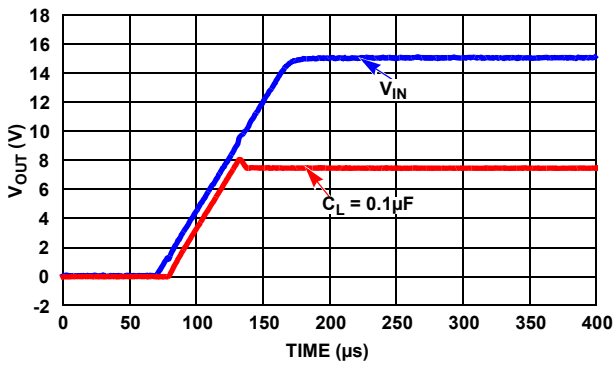

FIGURE 60. TURN-ON TIME WITH 0.1 μ F

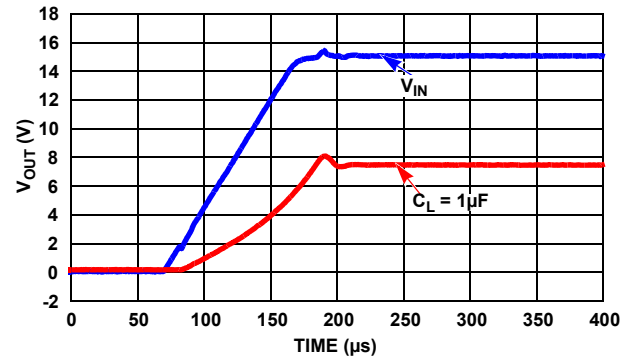

FIGURE 61. TURN-ON TIME WITH 1 μ F

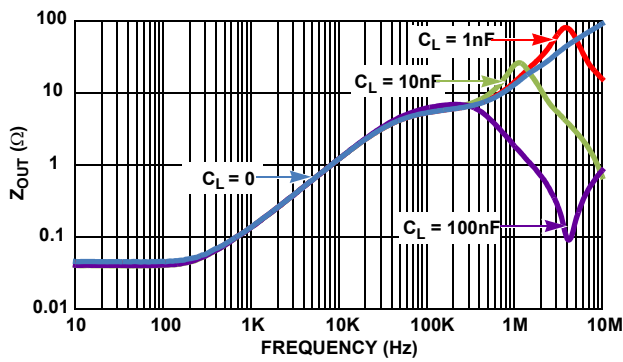

FIGURE 62. Z_{OUT} vs FREQUENCY

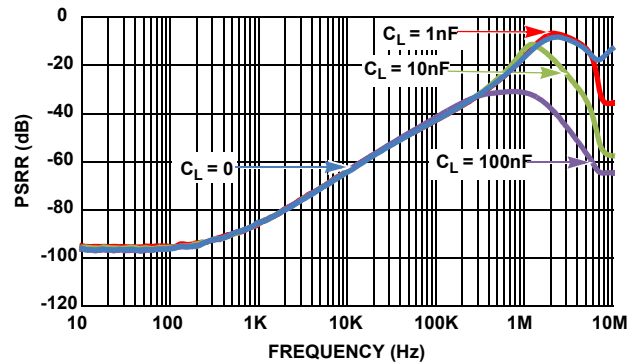

FIGURE 63. PSRR AT DIFFERENT CAPACITIVE LOADS

Typical Performance Curves (ISL21090-7.5) (Continued)

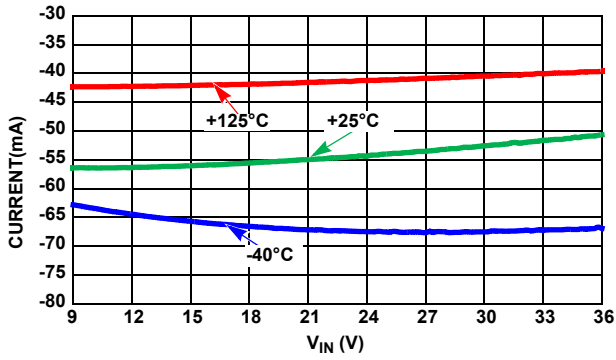

FIGURE 64. SHORT-CIRCUIT TO GND

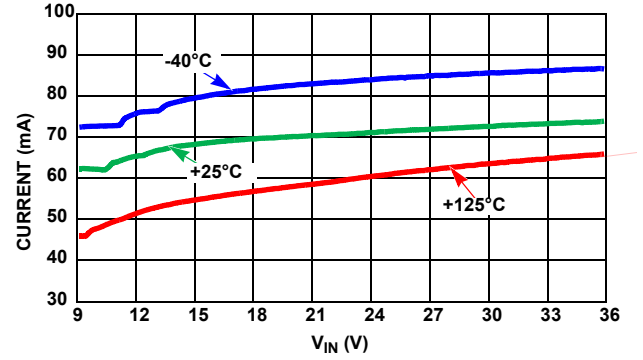

FIGURE 65. SHORT-CIRCUIT TO V_{IN}

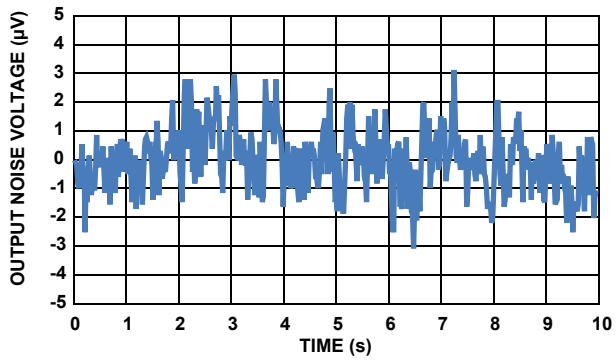

FIGURE 66. V_{OUT} vs NOISE, 0.1Hz TO 10Hz

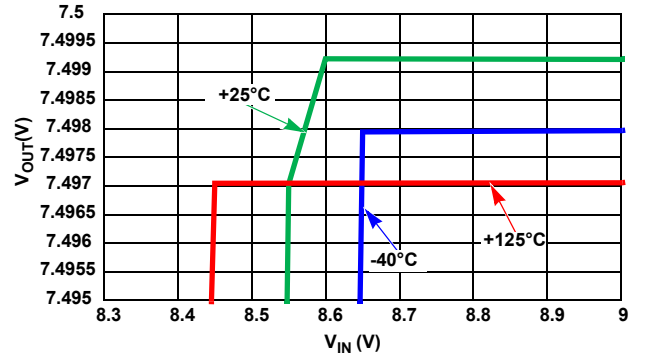

FIGURE 67. DROPOUT WITH -10mA LOAD

Device Operation

Precision Bandgap Reference

The ISL21090 uses a bandgap architecture and special trimming circuitry to produce a temperature compensated, precision voltage reference with high input voltage capability and moderate output current drive. Low noise performance is achieved using optimized biasing techniques. Key features for precision low noise portable applications, such as handheld meters and instruments, are supply current (900 μ A) and noise (0.1Hz to 10Hz bandwidth) 1.0 μ V_{P-P} to 6.2 μ V_{P-P}. Data Converters in particular can utilize the ISL21090 as an external voltage reference. Low power DAC and ADC circuits will realize maximum resolution with lowest noise. The device maintains output voltage during conversion cycles with fast response, although it is helpful to add an output capacitor, typically 1 μ F. In the case of the 1.25V option, a 0.01 μ F capacitor must be added to the COMP (pin 3) for stabilization purposes, and a minimum of 0.1 μ F capacitor must be added at the output.

Applications Information

Board Mounting Considerations

For applications requiring the highest accuracy, the board mounting location should be reviewed. The device uses a plastic SOIC package, which subjects the die to mild stresses when the printed circuit (PC) board is heated and cooled, which slightly changes the shape. Because of these die stresses, placing the device in areas subject to slight twisting can cause degradation of reference voltage accuracy. It is normally best to place the device near the edge of a board, or on the shortest side, because the axis of bending is most limited in that location. Mounting the device in a cutout also minimizes flex. Obviously, mounting the device on flexprint or extremely thin PC material will likewise cause loss of reference accuracy.

Board Assembly Considerations

Some PC board assembly precautions are necessary. Normal output voltage shifts of 100 μ V to 500 μ V can be expected with Pb-free reflow profiles or wave solder on multi-layer FR4 PC boards. Precautions should be taken to avoid excessive heat or extended exposure to high reflow or wave solder temperatures.

Noise Performance and Reduction

The output noise voltage in a 0.1Hz to 10Hz bandwidth is typically 1.9 μ V_{P-P} ($V_{OUT} = 2.5V$). The noise measurement is made with a bandpass filter. The filter is made of a 1-pole high-pass filter, with a corner frequency at 0.1Hz, and a 2-pole low-pass filter, with a corner frequency (3dB) at 9.9Hz, to create a filter with a 9.9Hz bandwidth. Noise in the 10Hz to 1kHz bandwidth is approximately 1.6 μ V_{RMS} ($V_{OUT} = 2.5V$), with 0.1 μ F capacitance on the output. This noise measurement is made with a 2 decade bandpass filter. The filter is made of a 1-pole high-pass filter with a corner frequency at 10Hz of the center frequency, and 1-pole low-pass filter with a corner frequency at 1kHz. Load capacitance up to 10 μ F can be added but will result in only marginal improvements in output noise and transient response.

Turn-On Time

Normal turn-on time is typically 150 μ s, as shown in Figure 27. The circuit designer must take this into account when looking at power-up delays or sequencing.

Temperature Coefficient

The limits stated for temperature coefficient (Tempco) are governed by the method of measurement. The overwhelming standard for specifying the temperature drift of a reference is to measure the reference voltage at two temperatures, take the total variation, ($V_{HIGH} - V_{LOW}$), and divide by the temperature extremes of measurement ($T_{HIGH} - T_{LOW}$). The result is divided by the nominal reference voltage (at $T = +25^{\circ}C$) and multiplied by 10^6 to yield ppm/ $^{\circ}C$. This is the "Box" method for specifying temperature coefficient.

Output Voltage Adjustment

The output voltage can be adjusted above and below the factory-calibrated value via the trim terminal. The trim terminal is the negative feedback divider point of the output op amp. The positive input of the amplifier is about 1.216V, and in feedback, so will be the trim voltage. The trim terminal has a 5000 Ω resistor to ground internally, and in the case of the 2.5V output version, there is a feedback resistor of approximately 5000 Ω from V_{OUT} to trim.

The suggested method to adjust the output is to connect a very high value external resistor directly to the trim terminal and connect the other end to the wiper of a potentiometer that has a much lower total resistance and whose outer terminals connect to V_{OUT} and ground. If a 1M Ω resistor is connected to trim, the output adjust range will be $\pm 6.3mV$. It is important to minimize the capacitance on the trim terminal to preserve output amplifier stability. It is also best to connect the series resistor directly to the trim terminal, to minimize that capacitance and also to minimize noise injection. Small trim adjustments will not disturb the factory-set temperature coefficient of the reference, but trimming near the extreme values can.

Revision History

The revision history provided is for informational purposes only and is believed to be accurate, but not warranted. Please go to web to make sure you have the latest revision.

| DATE | REVISION | CHANGE |
|------------------|----------|---|
| February 6, 2013 | FN6993.5 | Electrical Spec Table on page 3 - Noise Voltage Density changed Typ from "35.4" to "25" Removed Sinking: $-10\text{mA} \leq I_{\text{OUT}} \leq 0\text{mA}$ and ISC- Short Circuit Current Added Long Term Stability to options 2.5V, 5V and 7.5V on pages 4 and 5 Updated Figure 9 on page 7 by removing I_{LOAD} (mA) and Sinking and x-axis numbering changed from "-25 to 15" to "-25 to 0". Removed Figure which was titled "Short Circuit to V_{IN} " |
| January 9, 2013 | FN6993.4 | Added 7.5V option to Ordering Information table on page 2. Added 7.5V option "Electrical Specifications" table to page 5. Added 7.5V Typical Performance Curves section on page 15. |
| August 22, 2012 | FN6993.3 | Added 5.0V option "Typical Performance Curves" table to page 12. Removed 7.5V and 10V option Electrical Specs |
| May 1, 2012 | FN6993.2 | Added 5.0V option "Electrical Specifications" table to page 5. Added 7.5V option "Electrical Specifications" table to page 5. Added 10.0V option "Electrical Specifications" table to page 5. |
| March 5, 2012 | FN6993.1 | Added 1.25V option "Electrical Specifications" table to page 3. Added 1.25V Typical Performance Curves section on page 6. Changed MIN limit for V_{IN} 2.5V option on page 4. |
| June 8, 2011 | FN6993.0 | Initial Release |

About Intersil

Intersil Corporation is a leader in the design and manufacture of high-performance analog, mixed-signal and power management semiconductors. The company's products address some of the fastest growing markets within the industrial and infrastructure, personal computing and high-end consumer markets. For more information about Intersil or to find out how to become a member of our winning team, visit our website and career page at www.intersil.com.

For a complete listing of Applications, Related Documentation and Related Parts, please see the respective product information page. Also, please check the product information page to ensure that you have the most updated datasheet: [ISL21090B12](#), [ISL21090B25](#), [ISL21090B50](#), [ISL21090B75](#)

To report errors or suggestions for this datasheet, please go to: www.intersil.com/askourstaff

Reliability reports are available from our website at: <http://rel.intersil.com/reports/search.php>

© Copyright Intersil Americas LLC 2011-2013. All Rights Reserved.

All trademarks and registered trademarks are the property of their respective owners.

For additional products, see www.intersil.com/en/products.html

Intersil products are manufactured, assembled and tested utilizing ISO9001 quality systems as noted in the quality certifications found at www.intersil.com/en/support/qualandreliability.html

Intersil products are sold by description only. Intersil may modify the circuit design and/or specifications of products at any time without notice, provided that such modification does not, in Intersil's sole judgment, affect the form, fit or function of the product. Accordingly, the reader is cautioned to verify that datasheets are current before placing orders. Information furnished by Intersil is believed to be accurate and reliable. However, no responsibility is assumed by Intersil or its subsidiaries for its use; nor for any infringements of patents or other rights of third parties which may result from its use. No license is granted by implication or otherwise under any patent or patent rights of Intersil or its subsidiaries.

For information regarding Intersil Corporation and its products, see www.intersil.com

Package Outline Drawing

M8.15E

8 LEAD NARROW BODY SMALL OUTLINE PLASTIC PACKAGE

Rev 0, 08/09

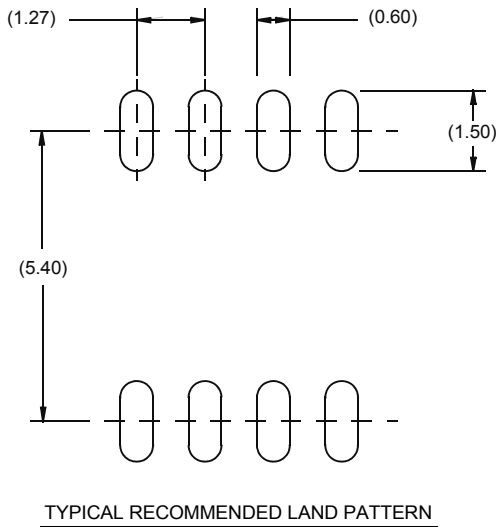
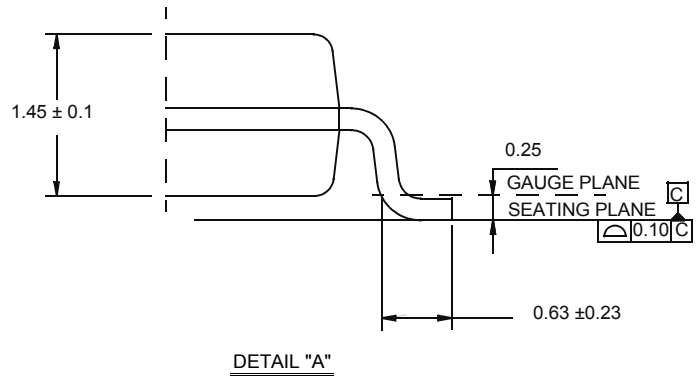
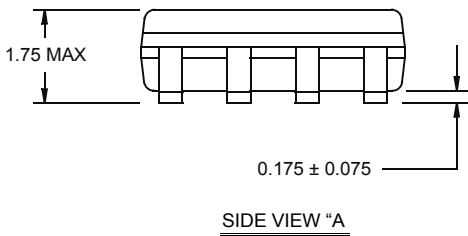
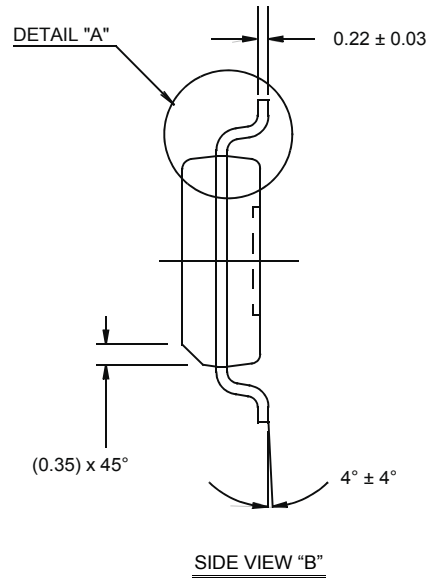
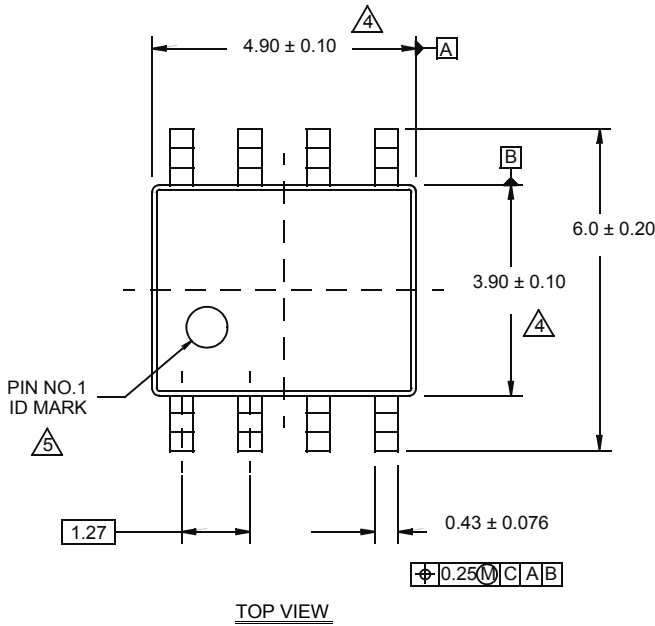

NOTES:

1. Dimensions are in millimeters.
Dimensions in () for Reference Only.
2. Dimensioning and tolerancing conform to AMSE Y14.5m-1994.
3. Unless otherwise specified, tolerance : Decimal ± 0.05
4. Dimension does not include interlead flash or protrusions.
Interlead flash or protrusions shall not exceed 0.25mm per side.
5. The pin #1 identifier may be either a mold or mark feature.
6. Reference to JEDEC MS-012.

Компания «Океан Электроники» предлагает заключение долгосрочных отношений при поставках импортных электронных компонентов на взаимовыгодных условиях!

Наши преимущества:

- Поставка оригинальных импортных электронных компонентов напрямую с производств Америки, Европы и Азии, а так же с крупнейших складов мира;
- Широкая линейка поставок активных и пассивных импортных электронных компонентов (более 30 млн. наименований);
- Поставка сложных, дефицитных, либо снятых с производства позиций;
- Оперативные сроки поставки под заказ (от 5 рабочих дней);
- Экспресс доставка в любую точку России;
- Помощь Конструкторского Отдела и консультации квалифицированных инженеров;
- Техническая поддержка проекта, помощь в подборе аналогов, поставка прототипов;
- Поставка электронных компонентов под контролем ВП;
- Система менеджмента качества сертифицирована по Международному стандарту ISO 9001;
- При необходимости вся продукция военного и аэрокосмического назначения проходит испытания и сертификацию в лаборатории (по согласованию с заказчиком);
- Поставка специализированных компонентов военного и аэрокосмического уровня качества (Xilinx, Altera, Analog Devices, Intersil, Interpoint, Microsemi, Actel, Aeroflex, Peregrine, VPT, Syfer, Eurofarad, Texas Instruments, MS Kennedy, Miteq, Cobham, E2V, MA-COM, Hittite, Mini-Circuits, General Dynamics и др.);

Компания «Океан Электроники» является официальным дистрибьютором и эксклюзивным представителем в России одного из крупнейших производителей разъемов военного и аэрокосмического назначения «JONHON», а так же официальным дистрибьютором и эксклюзивным представителем в России производителя высокотехнологичных и надежных решений для передачи СВЧ сигналов «FORSTAR».



JONHON

«JONHON» (основан в 1970 г.)

Разъемы специального, военного и аэрокосмического назначения:

(Применяются в военной, авиационной, аэрокосмической, морской, железнодорожной, горно- и нефтедобывающей отраслях промышленности)

«FORSTAR» (основан в 1998 г.)

ВЧ соединители, коаксиальные кабели, кабельные сборки и микроволновые компоненты:

(Применяются в телекоммуникациях гражданского и специального назначения, в средствах связи, РЛС, а так же военной, авиационной и аэрокосмической отраслях промышленности).



Телефон: 8 (812) 309-75-97 (многоканальный)

Факс: 8 (812) 320-03-32

Электронная почта: ocean@oceanchips.ru

Web: <http://oceanchips.ru/>

Адрес: 198099, г. Санкт-Петербург, ул. Калинина, д. 2, корп. 4, лит. А