

**Toggle Switches, Tiny, Part Number Matrix**

**MATERIAL SPECIFICATIONS:**

Contacts.....Gold over nickel or silver plate  
 Case Material.....Thermoplastic 94V-0  
 Terminals/Fixed Contacts.....Tin lead plate  
 Terminal Seal.....Epoxy on single pole, optional  
 on double pole  
 Process Seal.....ES version only (see page C16 - C17)

**ENVIRONMENTAL SPECIFICATIONS**

Operating Temperature.....-22°F to +185°F (-30°C to +85°C)  
 Storage Temperature.....-67°F to +185°F (-55°C to +85°C)  
 Solder Heat Resistance.....See page M3-4  
 U.L. (File E-46765).....Silver only

**TYPICAL PERFORMANCE CHARACTERISTICS:**

Contact Rating..... Gold: 0.4 VA max. @ 20 VDC or peak AC  
 Silver (2 pos.): 3 A @ 125 VAC or 28 VDC  
 Silver (3 pos.): 2 A @ 125 VAC or 28 VDC  
 Initial Contact Resistance..... 20 Milliohms max.  
 Contact Timing..... Break before Make  
 Insulation Resistance..... 1,000 Megohms 500 VDC min.  
 Dielectric Strength..... 1,000 Volts RMS @ sea level  
 Plunger/Actuator Travel..... 26°  
 High Torque Bushing Shoulder ..... Yes  
 Life Expectancy..... See chart below  
 Note: Hardware included with switch

TT Series

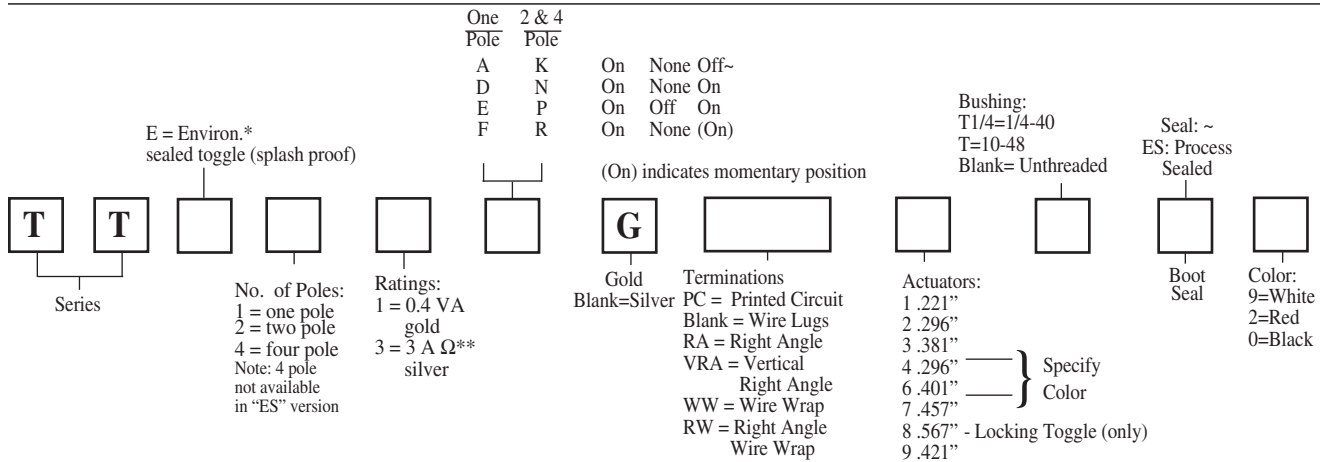

One Pole	0.4VA	80,000 (2 Pos.)	60,000 (3 Pos.)
Two Pole	0.4VA	80,000 (2 Pos.)	60,000 (3 Pos.)
Three Pole	3 Amp	20,000 (2 Pos.)	10,000 (3 Pos.)
Four Pole	0.4VA	80,000 (2 Pos.)	60,000 (3 Pos.)
Three Pole	3 Amp	20,000 (2 Pos.)	10,000 (3 Pos.)

**APPLICATION NOTE:**

For surface mount termination, use the "TST" series on page C5.  
 For 3 pole refer to the MT Series on page C43

Actuator Dimensions shown with	
1,2,3,4,6	10-48 bushing
7,8,9	1/4-40 bushing

\* Not available on 7 actuator or with VRA.  
 \*\* Not available in RA.  
 Ω Available in PC & WL only.  
 ~ Available in WL & PC only.

**TERMINATIONS**

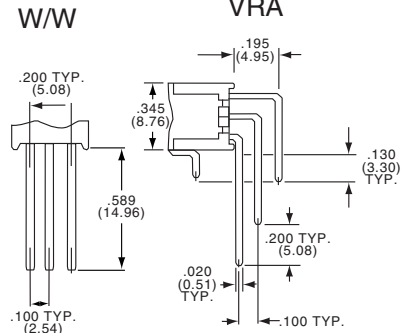
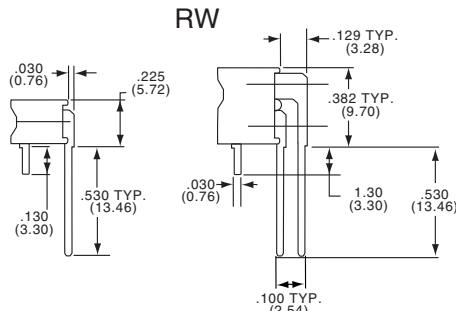
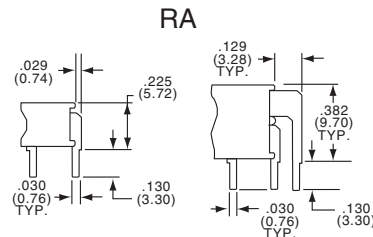
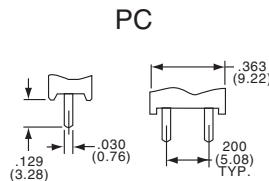
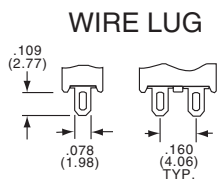

**Toggle Switches, Tiny, Actuator and Bushing Options**

Toggle Cap  
Series C-11\*  
Available



TT Series

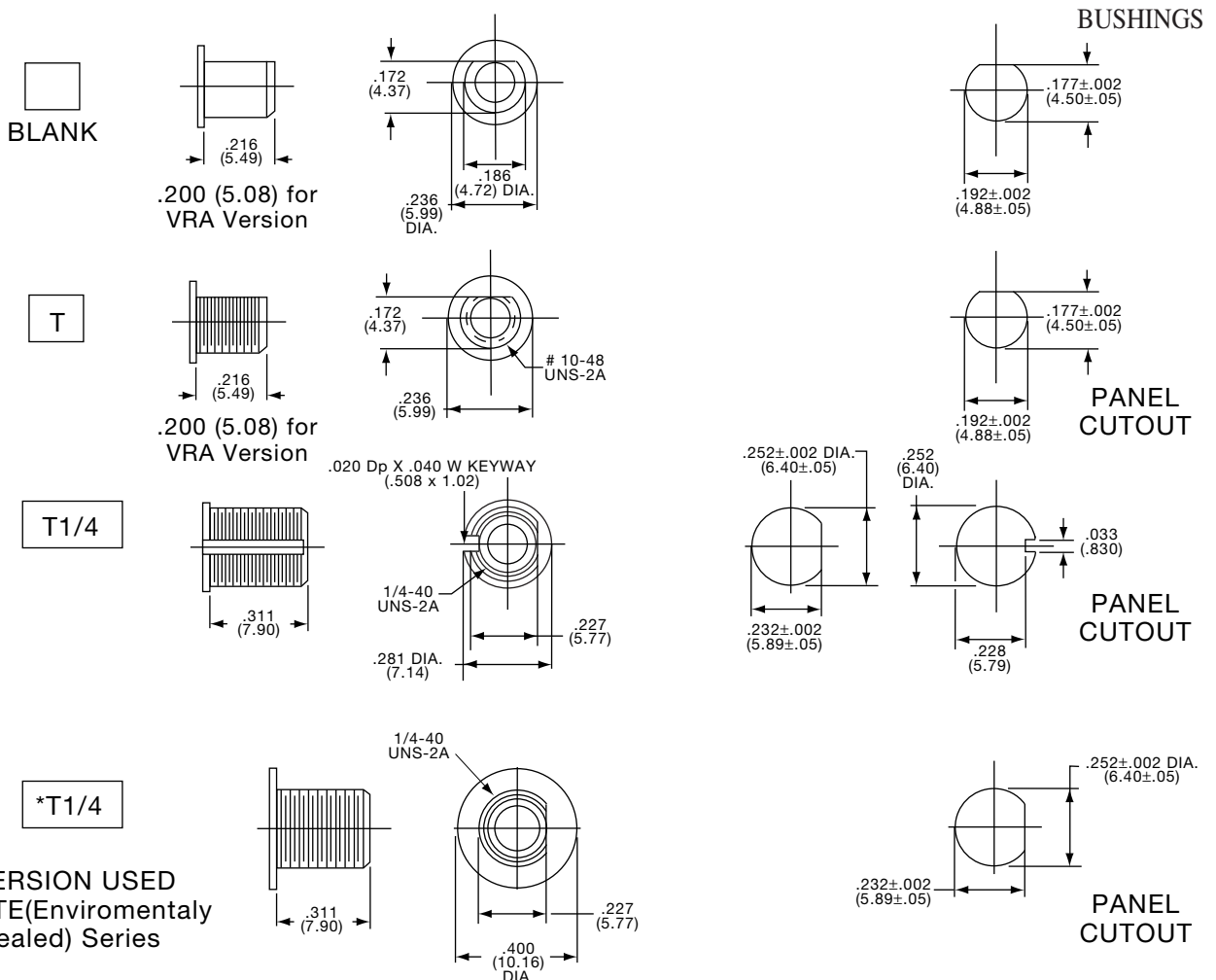

\*VERSION USED  
ON TTE(Enviromental  
Sealed) Series

**Toggle Switches, Tiny, Vertical, PC Mount**

TT Series

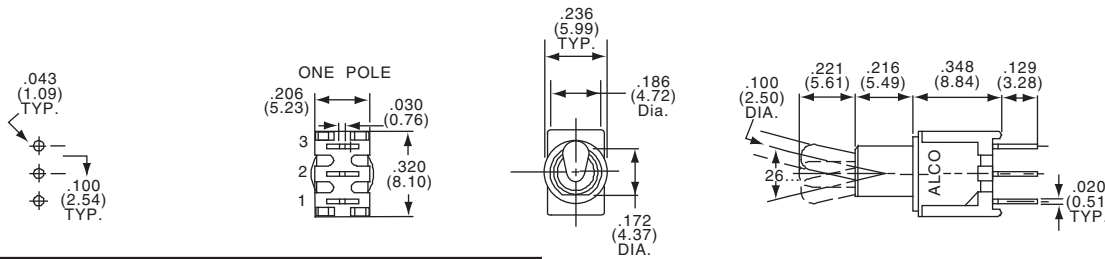

**1 POLE**  
For Terminal Connections refer to Code Chart (see page M5-6)



TT11DGPC1

Tyco Electronics	Alcoswitch	Type	Act. Code	P.	M5	↖	↓	↗
2-1437561-3	TT11AGPC1	SPST	A	On	None	Off		
2-1437561-6	TT11DGPC1	SPDT	D	On	None	On		
5-1437561-1	TT11EGPC1	SPDT	E	On	Off	On		

Note: No center terminal on "A" switches

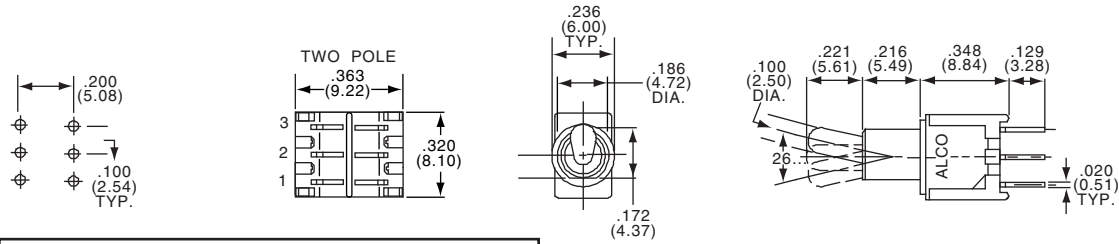

**2 POLE**  
For Terminal Connections refer to Code Chart (see page M5-6)



TT21NGPC1

Tyco Electronics	Alcoswitch	Type	Act. Code	P.	M5	↖	↓	↗
9-1437561-9	TT21KGPC1	DPST	K	On	None	Off		
1437562-3	TT21NGPC1	DPDT	N	On	None	On		
3-1437562-4	TT21PGPC1	DPDT	P	On	Off	On		

Note: No center terminal on "K" switches

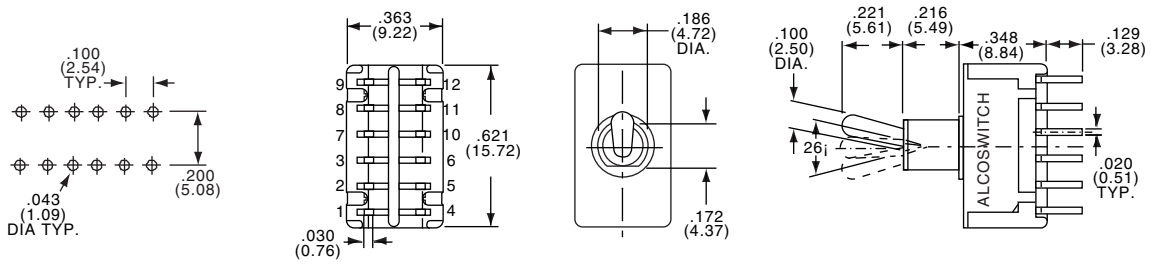

**4 POLE**

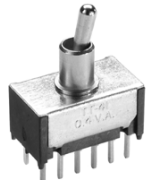

TT41NGPC1

Tyco Electronics	Alcoswitch	Type	Act. Code	P.	M5	↖	↓	↗
6-1437562-6	TT41NGPC1	4PDT	N	On	None	On		

**Toggle Switches, Tiny, Vertical and Vertical Right Angle, PC Mount**

SEE PAGE C8 FOR PRODUCT SPECIFICATIONS

For terminal connections refer to Code Chart on page M5-6

1 & 2 POLE

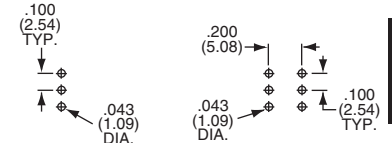
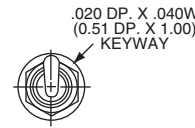
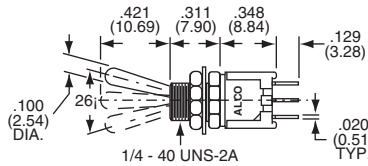

TT21NGPC9T1/4

TT1DGPC9T14

4 POLE

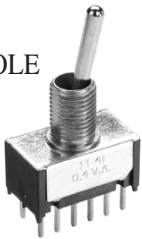

TT41NGPC9T1/4

Tyco Electronics	Alcoswitch	Type	Act.	Code	P.	M5	Tyco Electronics	Alcoswitch	Type	Act.	Code	P.	M5
2-1437561-5	TT11AGPC9T1/4	SPST	A	On	None	Off	1-1437562-1	TT21NGPC9T1/4	DPDT	N	On	None	On
3-1437561-5	TT11DGPC9T1/4	SPDT	D	On	None	On	3-1437562-8	TT21PGPC9T1/4	DPDT	P	On	Off	On
5-1437561-9	TT11EGPC9T1/4	SPDT	E	On	Off	On	4-1437562-6	TT21RGPC9T1/4	DPDT	R	On	None	(On)
7-1437561-3	TT11FGPC9T1/4	SPDT	F	On	None	On	6-1437562-8	TT41NGPC9T1/4	4PDT	N	On	None	On
1437562-1	TT21KGPC9T1/4	DPST	K	On	None	Off	7-1437562-5	TT41PGPC9T1/4	4PDT	P	On	Off	On

Note: No center terminal on "A" or "K" switches.

(On) indicates momentary position.

Note: Hardware Included

1 & 2 POLE



TT1DGVRA1  
Vertical Actuation

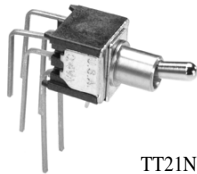

TT21NGVRA1  
Vertical Actuation

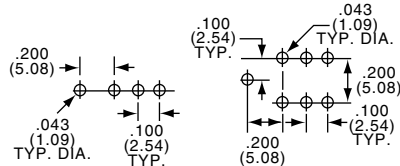
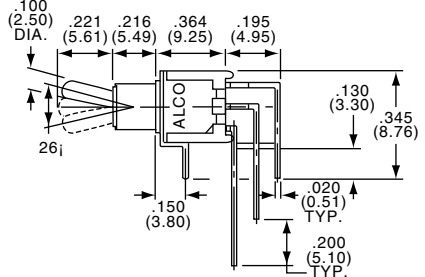
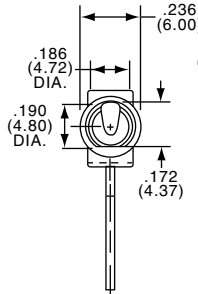
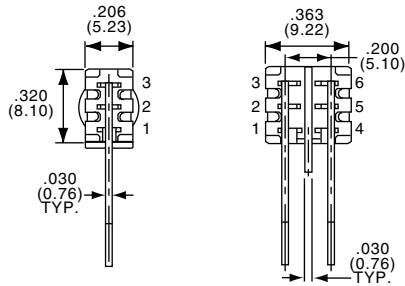

Tyco Electronics	Alcoswitch	Type	Act.	Code	P.	M5
4-1437561-8	TT11DGVRA1	SPDT	D	On	None	On
6-1437561-9	TT11EGVRA1	SPDT	E	On	Off	On
2-1437562-2	TT21NGVRA1	DPDT	N	On	None	On
4-1437562-3	TT21PGVRA1	DPDT	P	On	Off	On

1 & 2 POLE

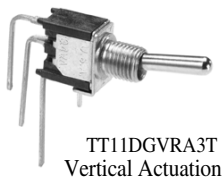

TT1DGVRA3T  
Vertical Actuation

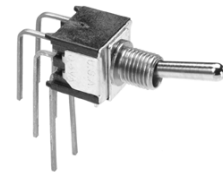

TT21NGVRA3T  
Vertical Actuation

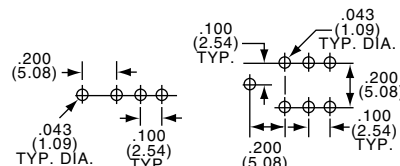
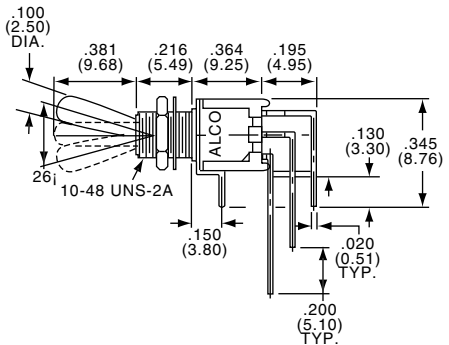
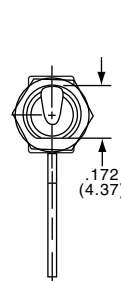
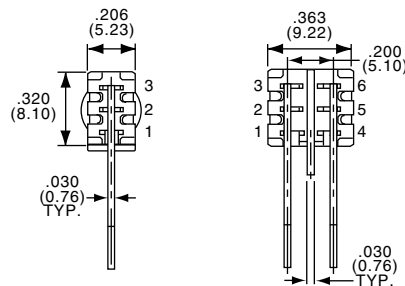

Tyco Electronics	Alcoswitch	Type	Act.	Code	P.	M5
4-1437561-9	TT11DGVRA3T	SPDT	D	On	None	On
7-1437561-0	TT11EGVRA3T	SPDT	E	On	Off	On
2-1437562-3	TT21NGVRA3T	DPDT	N	On	None	On

**Toggle Switches, Tiny, Right Angle, Flat Actuator**

SEE PAGE C8 FOR PRODUCT SPECIFICATIONS

\* Refer to Page C8 for Other Options \*

1 & 2 POLE FLAT

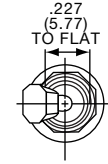
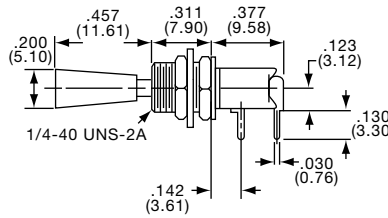
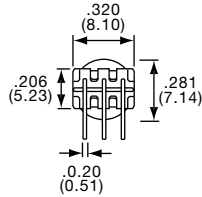
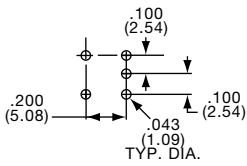

TT11DGRA7T1/4  
Horizontal Actuation

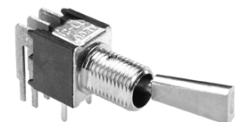
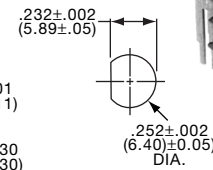
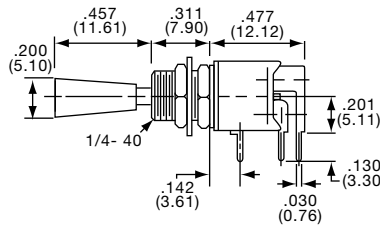
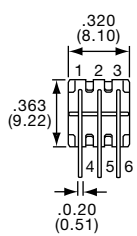
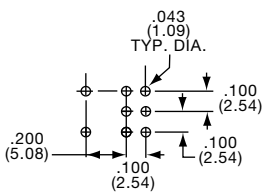

TT21NGRA7T1/4  
Horizontal Actuation

Tyco Electronics	Alcoswitch	Type	Act. Code	P. M5	On	None	On
4-1437561-5	TT11DGRA7T1/4	SPDT	D		On	None	On
6-1437561-7	TT11EGRA7T1/4	SPDT	E		On	Off	On
7-1437561-4	TT11FGRA7T1/4	SPDT	F		On	None	(On)
1-1437562-9	TT21NGRA7T1/4	DPDT	N		On	None	On
4-1437562-0	TT21PGRA7T1/4	DPDT	P		On	Off	On

(On) indicates momentary position

Pinned for Anti-Rotation

4 POLE FLAT

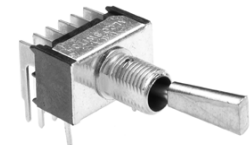
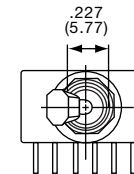
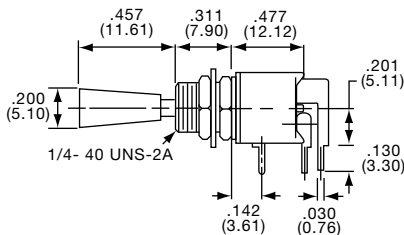
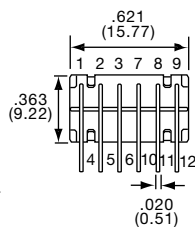
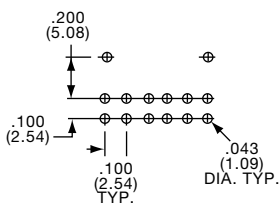

TT41NGRA7T14  
Horizontal Actuation

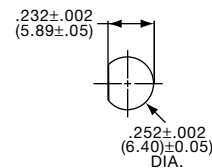

Tyco Electronics	Alcoswitch	Type	Act. Code	P. M5	On	None	On
7-1437562-2	TT41NGRA7T1/4	4PDT	N		On	None	On

Pinned for Anti-Rotation

**Toggle Switches, Tiny, Wire Wrap Termination**

SEE PAGE C8 FOR PRODUCT SPECIFICATIONS

For terminal connections refer to Code Chart on page M5-6

1 POLE



TT11DGWW2T

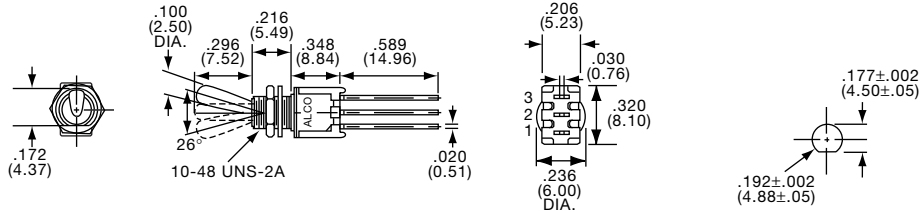

Tyco Electronics	Alcoswitch	Type	Act. Code P. M5		
5-1437561-0	TT11DGWW2T	SPDT	D	On	None On
7-1437561-1	TT11EGWW2T	SPDT	E	On	Off On

2 POLE



TT21NGWW2T

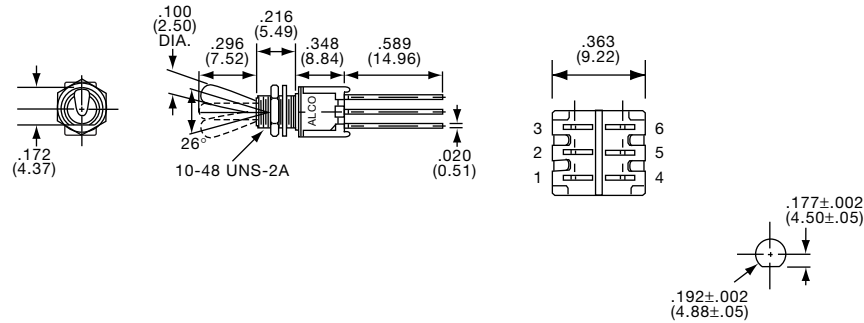

Tyco Electronics	Alcoswitch	Type	Act. Code P. M5		
2-1437562-4	TT21NGWW2T	DPDT	N	On	None On
4-1437562-4	TT21PGWW2T	DPDT	P	On	Off On

4 POLE

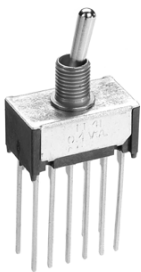

TT41NGWW2T



Tyco Electronics	Alcoswitch	Type	Act. Code P. M5		
7-1437562-4	TT41NGWW2T	4PDT	N	On	None On



**Toggle Switches, Tiny, Wire Lug, Round or Flat Actuators**

SEE PAGE C8 FOR PRODUCT SPECIFICATIONS

For terminal connections refer to Code Chart on page M5-6

NOTICE: Wire lug terminals accept two No. 20 AWG wires.



1 & 2 POLE



TT13D2T



TT23N2T

4 POLE

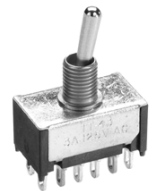

TT43N2T

Tyco Electronics	Alcoswitch	Type	Act. Code P. M5	On	None	Off	Tyco Electronics	Alcoswitch	Type	Act. Code P. M5	On	None	Off
7-1437561-8	TT13A2T	SPST	A	On	None	Off	5-1437562-1	TT23N2T	DPDT	N	On	None	On
8-1437561-5	TT13D2T	SPDT	D	On	None	On	5-1437562-7	TT23P2T	DPDT	P	On	Off	On
9-1437561-5	TT13E2T	SPDT	E	On	Off	On	7-1437562-6	TT43N2T	4PDT	N	On	None	On
4-1437562-7	TT23K2T	DPST	K	On	None	Off							

Note: No center terminal "A" or "K" action switches.

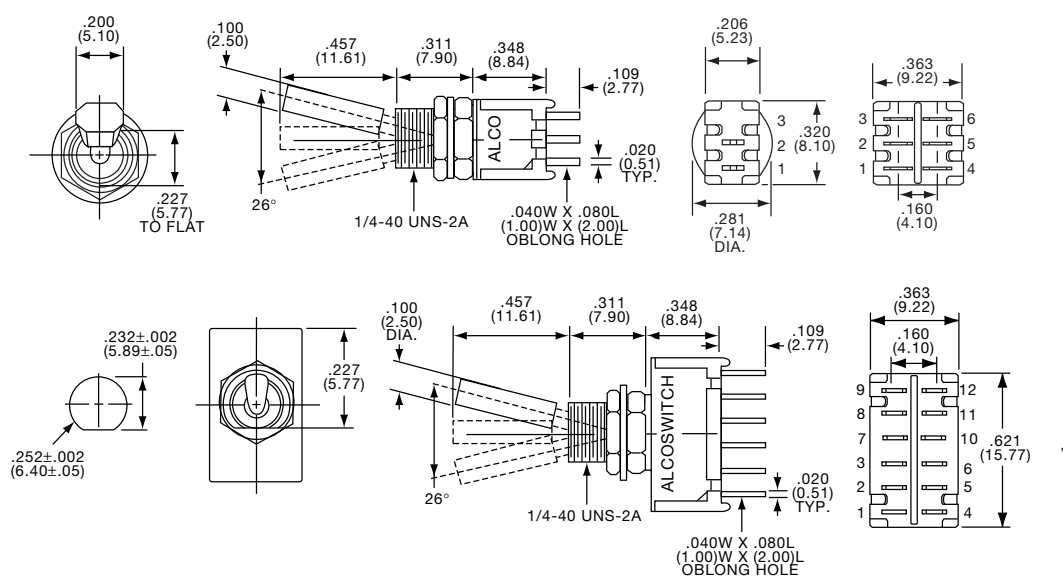

1 & 2 POLE



TT13D7T1/4



TT23N7T1/4

4 POLE



TT43N7T1/4

Pinned for Anti-Rotation

Tyco Electronics	Alcoswitch	Type	Act. Code P. M5	On	None	Off	Tyco Electronics	Alcoswitch	Type	Act. Code P. M5	On	None	Off
9-1437561-1	TT13D7T1/4	SPDT	D	On	None	On	6-1437562-0	TT23P7T1/4	DPDT	P	On	Off	On
9-1437561-7	TT13E7T1/4	SPDT	E	On	Off	On	7-1437562-8	TT43N7T1/4	4PDT	N	On	None	On
5-1437562-5	TT23N7T1/4	DPST	N	On	None	On		TT43P7T1/4	4PDT	P	On	Off	On

**Toggle Switches, Tiny, Wire Lug, Long Actuators**

SEE PAGE C8 FOR PRODUCT SPECIFICATIONS

For terminal connections refer to Code Chart on page M5-6

1 & 2 POLE



TT13D3T



TT23N3T

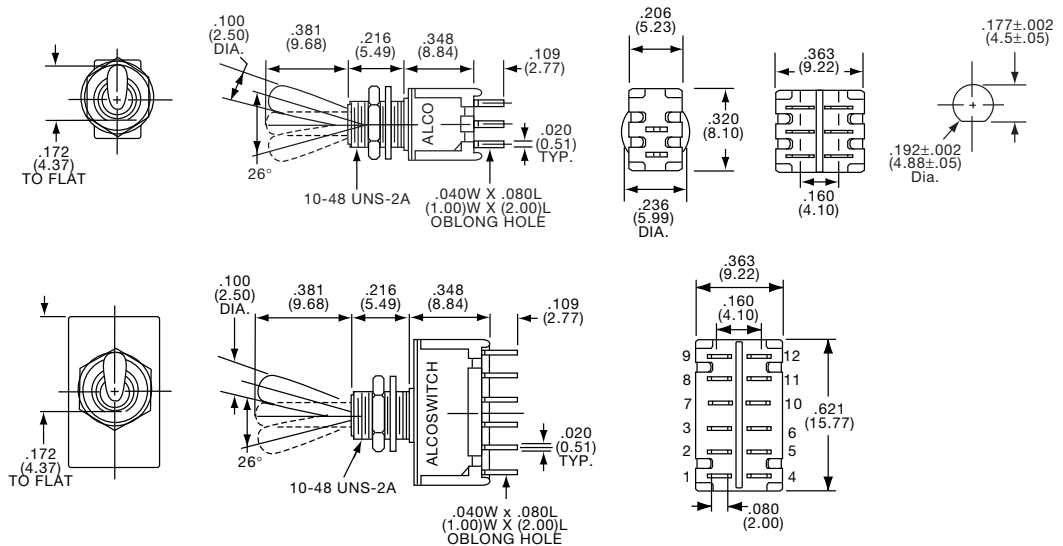

Tyco Electronics	Alcoswitch	Type	Act. Code	P. M5	On	None	Off	Tyco Electronics	Alcoswitch	Type	Act. Code	P. M5	On	None	Off
8-1437561-0	TT13A3T	SPST	A		On	None	Off	5-1437562-8	TT23P3T	DPDT	P		On	Off	On
8-1437561-8	TT13D3T	SPDT	D		On	None	On	7-1437562-7	TT43N3T	4PDT	N		On	None	On
9-1437561-6	TT13E3T	SPDT	E		On	Off	On	8-1437562-0	TT43P3T	4PDT	P		On	Off	On
4-1437562-8	TT23K3T	DPST	K		On	None	Off								
5-1437562-2	TT23N3T	DPDT	N		On	None	On								

Note: No center terminal on "A" or "K" action switches.

1 & 2 POLE



TT13A9T1/4



TT23N9T1/4

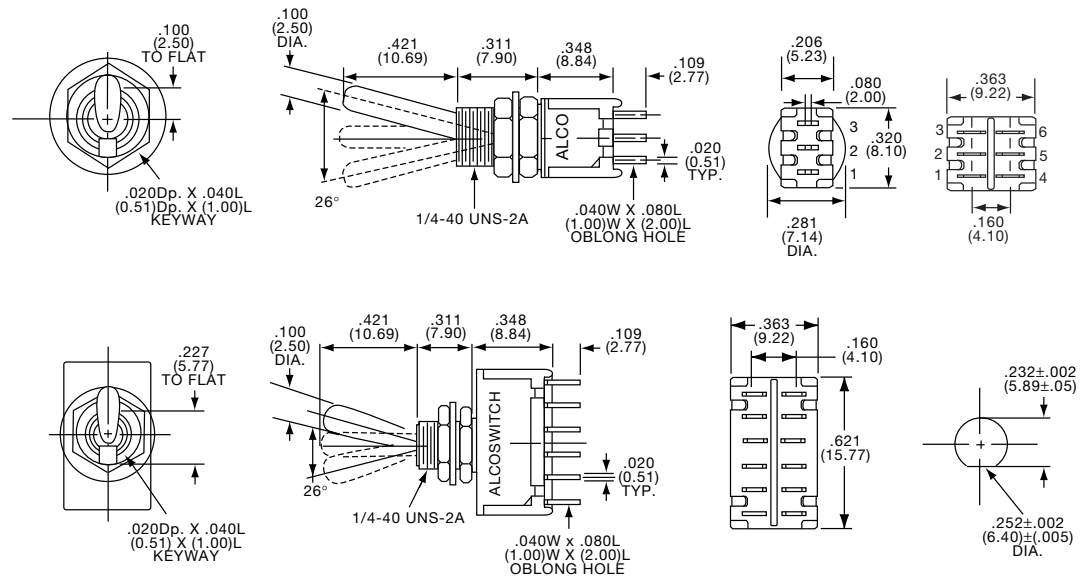

Tyco Electronics	Alcoswitch	Type	Act. Code	P. M5	On	None	Off	Tyco Electronics	Alcoswitch	Type	Act. Code	P. M5	On	None	Off
8-1437561-4	TT13A9T1/4	SPST	A		On	None	Off	6-1437562-2	TT23P9T1/4	DPDT	P		On	Off	On
9-1437561-2	TT13D9T1/4	SPDT	D		On	None	On	7-1437562-9	TT43N9T1/4	4PDT	N		On	None	On
9-1437561-8	TT13E9T1/4	SPDT	E		On	Off	On	8-1437562-1	TT43P9T1/4	4PDT	P		On	Off	On
4-1437562-9	TT23K9T1/4	DPST	K		On	None	Off								
5-1437562-6	TT23N9T1/4	DPDT	N		On	None	On								

Note: No center terminal on "A" or "K" action switches.

4 POLE



TT43N9T1/4



**Toggle Switches, Process Sealed, Vertical**

**MATERIAL SPECIFICATIONS:**

Contacts .....Gold over nickel  
 Inner Case Material .....High temperature polyester  
 Outer Case Material .....Polyamide  
 Terminals/Fixed Contacts .....Tin lead plate  
 Terminal Seal .....Epoxy  
 Process Seal .....Disposable boot, epoxied double case

**TYPICAL PERFORMANCE CHARACTERISTICS:**

Contact Rating .....0.4VA Max. @ 20 VDC or peak AC  
 Initial Contact Resistance.....20 Milliohms max.  
 Contact Timing.....Break-before-make  
 Insulation Resistance .....1,000 Megohms min. 500 VDC  
 Dielectric Strength .....1,000 Volts RMS @ sea level  
 Plunger/Actuator Travel......26°  
 Life Expectancy .....See page C8

**ENVIRONMENTAL SPECIFICATIONS**

Operating Temperature .....-22°F to +185°F (-30°C to +85°C)  
 Storage Temperature .....-67°F to +185°F (-55°C to +85°C)  
 Solder Heat Resistance.....See page M3-4

**APPLICATION NOTE: Each switch is provided with a disposable boot used only during cleaning operation.**

\* Refer to Page C8 for Other Options \*

Note: Hardware included with switch

TT-ES Series

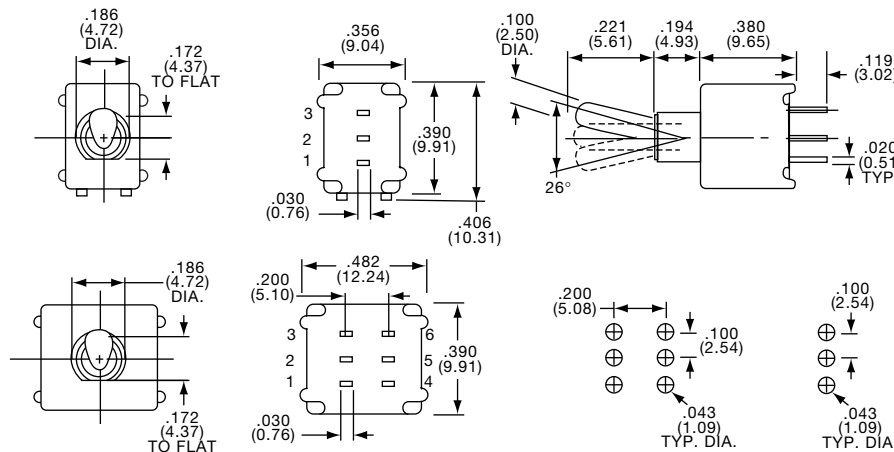

1 & 2 POLE  
UNTHREADED BUSHING



TT11DGPC1ES

Tyco Electronics	Alcoswitch	Type	Act. Code P. M5	On	None	Off	Tyco Electronics	Alcoswitch	Type	Act. Code P. M5	On	None	On
2-1437561-4	TT11AGPC1ES	SPST	A	On	None	Off	1437562-4	TT21NGPC1ES	DPDT	N	On	None	On
2-1437561-7	TT11DGPC1ES	SPDT	D	On	None	On							

Note: No center terminal "A".

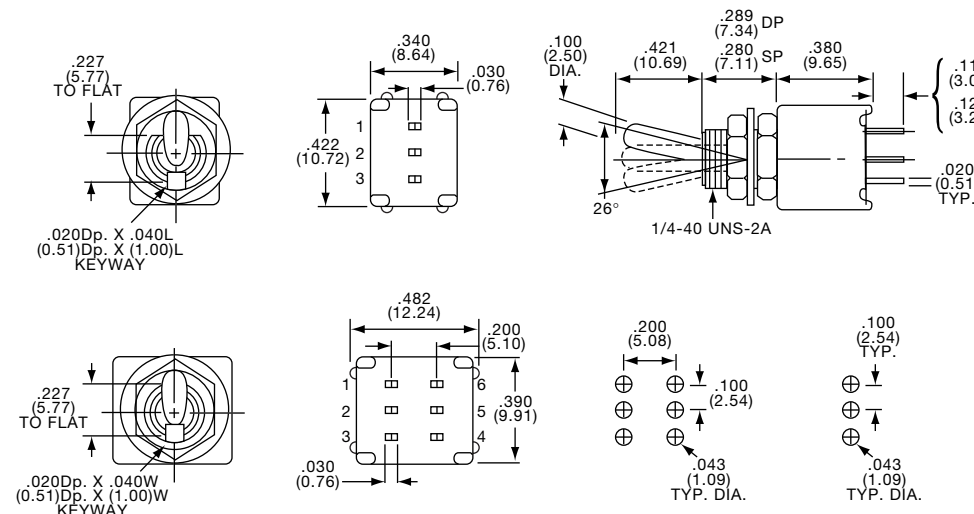

1 & 2 POLE  
THREADED BUSHING

TT11DGPC9T1/4ES



TT21NGPC9T1/4ES



Tyco Electronics	Alcoswitch	Type	Act. Code P. M5	On	None	Off	Tyco Electronics	Alcoswitch	Type	Act. Code P. M5	On	None	On
	TT11AGPC9T1/4ES	SPST	A	On	None	Off	1-1437562-2	TT21NGPC9T1/4ES	DPDT	N	On	None	On
6-1437830-2	TT11DGPC9T1/4ES	SPDT	D	On	None	On		TT21PGPC9T1/4ES	DPDT	P	On	Off	On
	TT11EGPC9T1/4ES	SPDT	E	On	Off	(On)							
	TT21KGPC9T1/4ES	DPST	K	On	None	Off							

Note: No center terminal "A" or "K" action switches.  
 (On) indicates momentary position.

**Toggle Switches, Tiny, Enviromental and Process Sealed**

SEE PAGE C16 FOR PRODUCT SPECIFICATIONS

For terminal connections refer to Code Chart on page M5-6

**1 POLE-PC VERTICAL MOUNT**



Tyco Electronics	Alcoswitch	Type	Act. Code	P. M5			
8-1437562-6	TTE11DGPC1ES	SPDT	D		On	None	On
	TTE11EGPC1ES	SPDT	E		On	Off	On

**2 POLE-PC VERTICAL MOUNT**

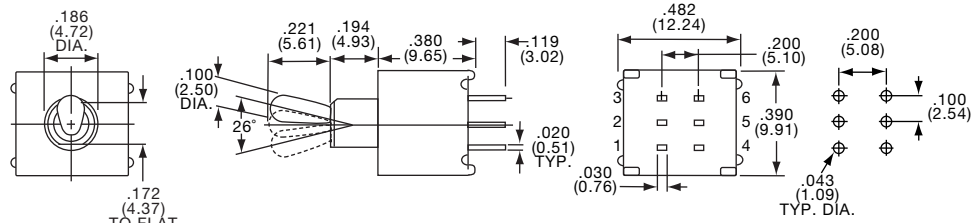

Tyco Electronics	Alcoswitch	Type	Act. Code	P. M5			
1437563-1	TTE21NGPC1ES	DPDT	N		On	None	On
	TTE21PGPC1ES	DPDT	P		On	Off	On

**1 POLE-PC RIGHT ANGLE**



TTE11DGRA1ES  
Horizontal Actuation

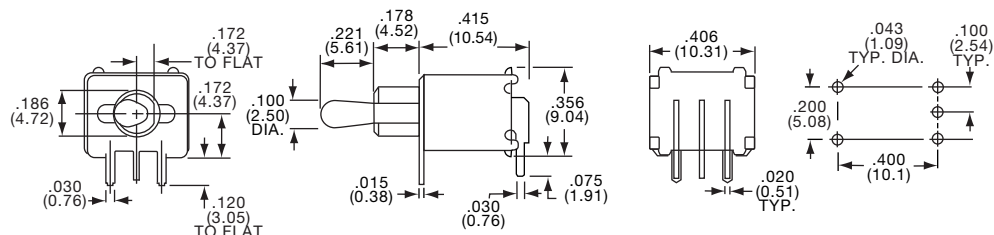

Tyco Electronics	Alcoswitch	Type	Act. Code	P. M5			
8-1437562-9	TTE11DGRA1ES	SPDT	D		On	None	On
9-1437562-2	TTE11EGRA1ES	SPDT	E		On	Off	On

**2 POLE-PC RIGHT ANGLE**



TTE21NGRA1ES  
Horizontal Actuation

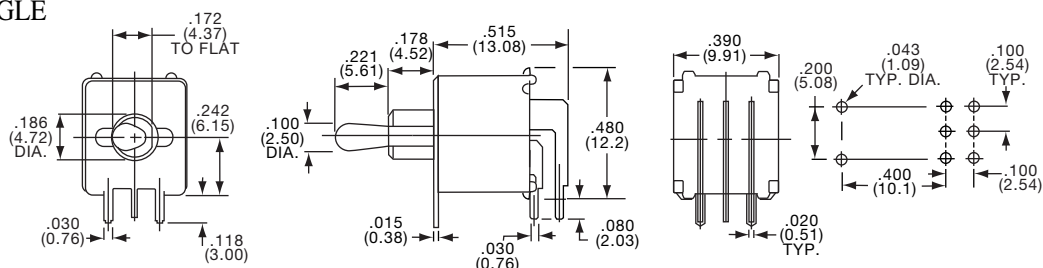

Tyco Electronics	Alcoswitch	Type	Act. Code	P. M5			
1437563-4	TTE21NGRA1ES	DPDT	N		On	None	On
	TTE21PGRA1ES	DPDT	P		On	Off	On

**Toggle Switches, Tiny, Enviromental and Process Sealed**

For terminal connections refer to Code Chart on page M5-6.

SEE PAGE C16 FOR PRODUCT SPECIFICATIONS

\* Refer to Page C8 for Other Options \*

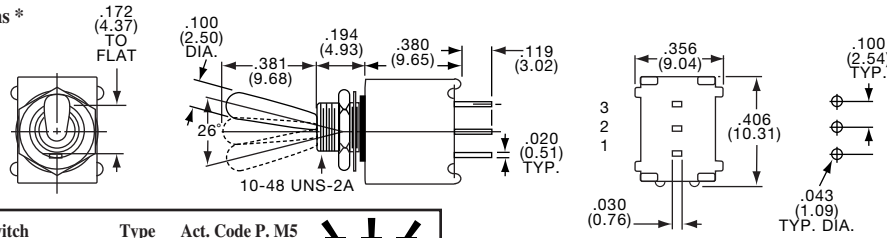

1 POLE



TTE11DGPC3TES

Tyco Electronics	Alcoswitch	Type	Act. Code	P. M5	On	None	Off
8-1437562-5	TTE11AGPC3TES	SPST	A		On	None	Off
8-1437562-7	TTE11DGPC3TES	SPDT	D		On	None	On
9-1437562-0	TTE11EGPC3TES	SPDT	E		On	Off	On

Note: No center terminal on "A" action switches.

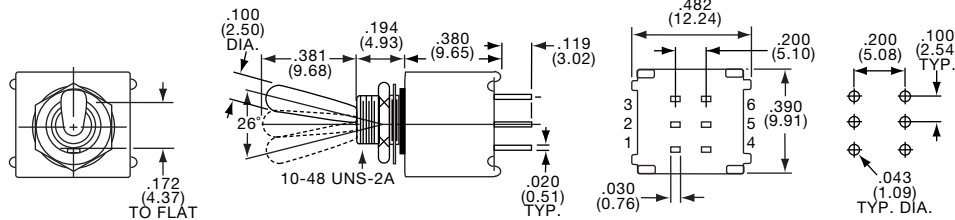

2 POLE



TTE21NGPC3TES

Tyco Electronics	Alcoswitch	Type	Act. Code	P. M5	On	None	On
1437563-2	TTE21NGPC3TES	DPDT	N		On	None	On
	TTE21PGPC3TES	DPDT	P		On	Off	On

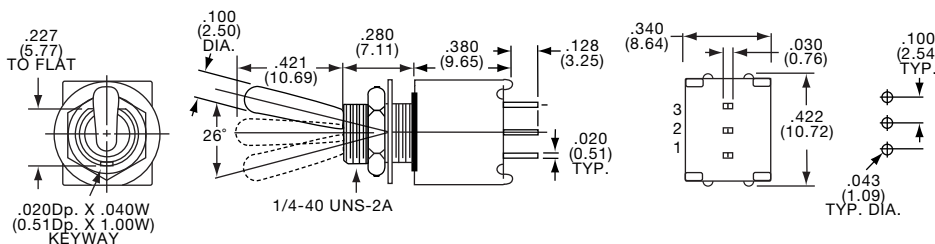

1 POLE



TTE11DGPC9T4ES

Tyco Electronics	Alcoswitch	Type	Act. Code	P. M5	On	None	Off
	TTE11AGPC9T1/4ES	SPST	A		On	None	Off
8-1437562-8	TTE11DGPC9T1/4ES	SPDT	D		On	None	On
9-1437562-1	TTE11EGPC9T1/4ES	SPDT	E		On	Off	On

Note: No center terminal on "A" action switches.

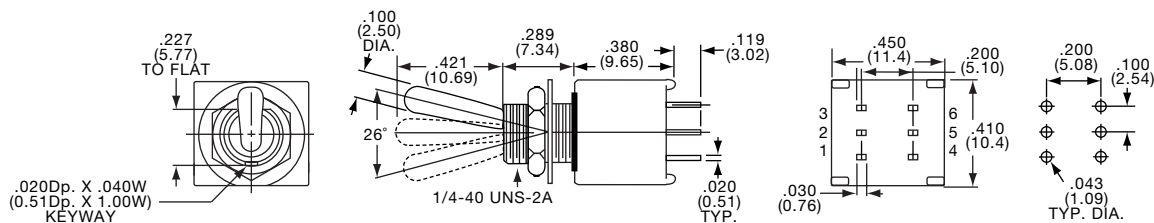

2 POLE



TTE21NGPC9T4ES

Tyco Electronics	Alcoswitch	Type	Act. Code	P. M5	On	None	Off
	TTE21KGPC9T1/4ES	DPST	K		On	None	Off
1437563-3	TTE21NGPC9T1/4ES	DPDT	N		On	None	On
	TTE21PGPC9T1/4ES	DPDT	P		On	Off	On

Note: No center terminal on "K" action switches.

Компания «Океан Электроники» предлагает заключение долгосрочных отношений при поставках импортных электронных компонентов на взаимовыгодных условиях!

Наши преимущества:

- Поставка оригинальных импортных электронных компонентов напрямую с производств Америки, Европы и Азии, а так же с крупнейших складов мира;
- Широкая линейка поставок активных и пассивных импортных электронных компонентов (более 30 млн. наименований);
- Поставка сложных, дефицитных, либо снятых с производства позиций;
- Оперативные сроки поставки под заказ (от 5 рабочих дней);
- Экспресс доставка в любую точку России;
- Помощь Конструкторского Отдела и консультации квалифицированных инженеров;
- Техническая поддержка проекта, помощь в подборе аналогов, поставка прототипов;
- Поставка электронных компонентов под контролем ВП;
- Система менеджмента качества сертифицирована по Международному стандарту ISO 9001;
- При необходимости вся продукция военного и аэрокосмического назначения проходит испытания и сертификацию в лаборатории (по согласованию с заказчиком);
- Поставка специализированных компонентов военного и аэрокосмического уровня качества (Xilinx, Altera, Analog Devices, Intersil, Interpoint, Microsemi, Actel, Aeroflex, Peregrine, VPT, Syfer, Eurofarad, Texas Instruments, MS Kennedy, Miteq, Cobham, E2V, MA-COM, Hittite, Mini-Circuits, General Dynamics и др.);

Компания «Океан Электроники» является официальным дистрибьютором и эксклюзивным представителем в России одного из крупнейших производителей разъемов военного и аэрокосмического назначения «JONHON», а так же официальным дистрибьютором и эксклюзивным представителем в России производителя высокотехнологичных и надежных решений для передачи СВЧ сигналов «FORSTAR».



## JONHON

«JONHON» (основан в 1970 г.)

Разъемы специального, военного и аэрокосмического назначения:

(Применяются в военной, авиационной, аэрокосмической, морской, железнодорожной, горно- и нефтедобывающей отраслях промышленности)

«FORSTAR» (основан в 1998 г.)

ВЧ соединители, коаксиальные кабели,  
кабельные сборки и микроволновые компоненты:

(Применяются в телекоммуникациях гражданского и специального назначения, в средствах связи, РЛС, а так же военной, авиационной и аэрокосмической отраслях промышленности).



Телефон: 8 (812) 309-75-97 (многоканальный)

Факс: 8 (812) 320-03-32

Электронная почта: [ocean@oceanchips.ru](mailto:ocean@oceanchips.ru)

Web: <http://oceanchips.ru/>

Адрес: 198099, г. Санкт-Петербург, ул. Калинина, д. 2, корп. 4, лит. А