

Description

The 74LVC1G86 is a single 2-input EXCLUSIVE OR gate with a standard push-pull output. The device is designed for operation with a power supply range of 1.65V to 5.5V. The inputs are tolerant to 5.5V allowing this device to be used in a mixed voltage environment. The device is fully specified for partial power down applications using I_{OFF}. The I_{OFF} circuitry disables the output preventing damaging current backflow when the device is powered down.

The gate performs the positive Boolean function:

$$Y = A \oplus B \text{ or } Y = \overline{A}B + A\overline{B}$$

Features

- Wide Supply Voltage Range from 1.65 to 5.5V
- ± 24mA Output Drive at 3.3V
- CMOS low power consumption
- I_{OFF} Supports Partial-Power-Down Mode Operation
- Inputs accept up to 5.5V
- ESD Protection Tested per JESD 22
 - Exceeds 200-V Machine Model (A115-A)
 - Exceeds 2000-V Human Body Model (A114-A)
 - Exceeds 1000-V Charged Device Model (C101C)
- Latch-Up Exceeds 100mA per JESD 78, Class II
- Range of Package Options
- Direct Interface with TTL Levels
- All packages Assembled with “Green” Molding Compound (no Br, Sb)
- Lead Free Finish/ RoHS Compliant (Note 1)

Notes: 1. EU Directive 2002/95/EC (RoHS) & 2011/65/EU (RoHS 2) compliant. No purposely added lead. Halogen and Antimony free. Please visit our website at http://www.diodes.com/products/lead_free.html

Pin Assignments

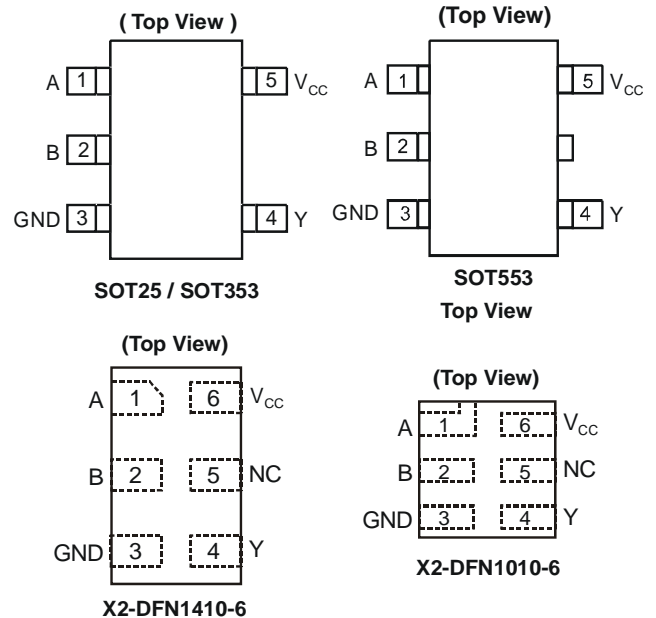

Applications

- Voltage Level Shifting
- Bus Driver / Repeater
- Parity Bit Generation
- Selectable signal Inverter
- Power Down Signal Isolation
- General Purpose Logic
- Wide array of products such as:
 - PCs, networking, notebooks, netbooks, PDAs
 - Tablet Computers, E-readers
 - Computer peripherals, hard drives, CD/DVD ROM
 - TV, DVD, DVR, set top box
 - Cell Phones, Personal Navigation / GPS
 - MP3 players, Cameras, Video Recorders

Pin Descriptions

Pin Name	Description
A	Data Input
B	Data Input
GND	Ground
Y	Data Output
V _{CC}	Supply Voltage
NC	No Connection

Logic Diagram

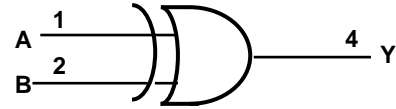

Function Table

Inputs		Output
A	B	Y
H	H	L
L	H	H
H	L	H
L	L	L

Absolute Maximum Ratings (Note 2)

Symbol	Description	Rating	Unit
ESD HBM	Human Body Model ESD Protection	2	KV
ESD CDM	Charged Device Model ESD Protection	1	KV
ESD MM	Machine Model ESD Protection	200	V
V _{CC}	Supply Voltage Range	-0.5 to 6.5	V
V _I	Input Voltage Range	-0.5 to 6.5	V
V _O	Voltage applied to output in high impedance or I _{OFF} state	-0.5 to 6.5	V
V _O	Voltage applied to output in high or low state.	-0.3 to V _{CC} +0.5	V
I _{IK}	Input Clamp Current V _I <0	-50	mA
I _{OK}	Output Clamp Current	-50	mA
I _O	Continuous output current	±50	mA
I _{CC} , I _{GND}	Continuous current through V _{CC} or GND	±100	mA
T _J	Operating Junction Temperature	-40 to 150	°C
T _{STG}	Storage Temperature	-65 to 150	°C

Notes: 2. Stresses beyond the absolute maximum may result in immediate failure or reduced reliability. These are stress values and device operation should be within recommend values.

Recommended Operating Conditions (Note 3)

Symbol	Parameter	Min	Max	Unit	
V _{CC}	Operating Voltage	Operating	1.65	5.5	V
		Data retention only	1.5		V
V _{IH}	High-level Input Voltage	V _{CC} = 1.65V to 1.95V	0.65 X V _{CC}		V
		V _{CC} = 2.3V to 2.7V	1.7		
		V _{CC} = 3V to 3.6V	2		
		V _{CC} = 4.5V to 5.5V	0.7 X V _{CC}		
V _{IL}	Low-level input voltage	V _{CC} = 1.65V to 1.95V		0.35 X V _{CC}	V
		V _{CC} = 2.3V to 2.7V		0.7	
		V _{CC} = 3V to 3.6V		0.8	
		V _{CC} = 4.5V to 5.5V		0.3 X V _{CC}	
V _I	Input Voltage	0	5.5	V	
V _O	Output Voltage	0	V _{CC}	V	
I _{OH}	High-level output current	V _{CC} = 1.65V		-4	mA
		V _{CC} = 2.3V		-8	
		V _{CC} = 3V		-16	
		V _{CC} = 4.5V		-24	
I _{OL}	Low-level output current	V _{CC} = 1.65V		4	mA
		V _{CC} = 2.3V		8	
		V _{CC} = 3V		16	
		V _{CC} = 4.5V		24	
Δt/ΔV	Input transition rise or fall rate	V _{CC} = 1.8V ± 0.15V, 2.5V ± 0.2V		20	ns/V
		V _{CC} = 3.3V ± 0.3V		10	
		V _{CC} = 5V ± 0.5V		5	
T _A	Operating free-air temperature	-40	125	°C	

Notes: 3. Unused inputs should be held at V_{CC} or Ground.

Electrical Characteristics (All typical values are at $V_{CC} = 3.3V$, $T_A = 25^\circ C$)

Symbol	Parameter	Test Conditions	Vcc	-40°C to 85°C			-40°C to 125°C		Unit
				Min	Typ.	Max	Min	Max	
V_{OH}	High Level Output Voltage	$I_{OH} = -100\mu A$	1.65V to 5.5V	$V_{CC} - 0.1$			$V_{CC} - 0.1$		V
		$I_{OH} = -4mA$	1.65V	1.2		0.95			
		$I_{OH} = -8mA$	2.3V	1.9		1.7			
		$I_{OH} = -16mA$	3V	2.4		2.2			
		$I_{OH} = -24mA$		2.3		2.0			
		$I_{OH} = -32mA$	4.5V	3.8		3.4			
V_{OL}	Low Level Output Voltage	$I_{OL} = 100\mu A$	1.65V to 5.5V			0.1		0.1	V
		$I_{OL} = 4mA$	1.65V			0.45		0.7	
		$I_{OL} = 8mA$	2.3V			0.3		0.45	
		$I_{OL} = 16mA$	3V			0.4		0.6	
		$I_{OL} = 24mA$				0.55		0.8	
		$I_{OL} = 32mA$	4.5V			0.55		.8	
I_I	Input Current	$V_I = 5.5V$ or GND	0 to 5.5V		± 0.1	± 5		± 100	μA
I_{OFF}	Power Down Leakage Current	V_I or $V_O = 5.5V$	0V			± 10		± 200	μA
I_{CC}	Supply Current	$V_I = 5.5V$ or GND $I_O = 0$	5.5V		0.1	10		200	μA
ΔI_{CC}	Additional Supply Current	One input at $V_{CC} - 0.6V$ Other inputs at V_{CC} or GND	3V to 5.5V			500		5000	μA
C_i	Input Capacitance	$V_I = V_{CC} -$ or GND	3.3V		5				pF

Package Characteristics (All typical values are at $V_{CC} = 3.3V$, $T_A = 25^\circ C$)

Symbol	Parameter	Test Conditions	V_{CC}	Min	Typ.	Max	Unit
θ_{JA}	Thermal Resistance Junction-to-Ambient	SOT25	(Note 4)		204		$^\circ C/W$
		SOT353			371		
		SOT553			231		
		X2-DFN1010-6			445		
		X2-DFN1410-6			460		
θ_{JC}	Thermal Resistance Junction-to-Case	SOT25	(Note 4)		52		$^\circ C/W$
		SOT353			143		
		SOT553			105		
		X2-DFN1010-6			250		
		X2-DFN1410-6			265		

Notes: 4. Test condition for SOT25, SOT353, SOT553, X2-DFN1410-6 and X2-DFN1010-6: Device mounted on FR-4 substrate PC board, 2oz copper, with minimum recommended pad layout.

Switching Characteristics

Figure 1 Typical Values at $T_A = 25^\circ C$ and nominal voltages 1.8V, 2.5V, 2.7V, 3.3V, and 5.0V.

Parameter	From Input	To Output	V_{CC}	$T_A = -40^\circ C$ to $85^\circ C$			$T_A = -40^\circ C$ to $125^\circ C$		Unit
				Min	Typ.	Max	Min	Max	
t_{pd}	A or B	Y	$1.8V \pm 0.15V$	1.0	3.7	9.9	1.0	13.0	ns
			$2.5V \pm 0.2V$	0.5	2.5	5.5	0.5	7.0	
			2.7V	0.5	2.8	5.8	0.5	7.5	
			$3.3V \pm 0.3V$	0.5	2.3	5.0	0.5	6.5	
			$5.0V \pm 0.5V$	0.5	1.9	4.0	0.5	5.5	

Operating Characteristics

$T_A = 25^\circ C$

Parameter	Test Conditions	$V_{CC} = 1.8V$	$V_{CC} = 2.5V$	$V_{CC} = 3.3V$	$V_{CC} = 5V$	Unit	
		Typ.	Typ.	Typ.	Typ.		
C_{pd}	Power dissipation capacitance	f = 10 MHz	14	14	14	14	pF

Parameter Measurement Information

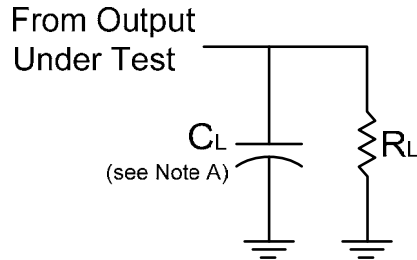

V _{CC}	Inputs		V _M	C _L	R _L
	V _I	t _r /t _f			
1.8V ± 0.15V	V _{CC}	≤2ns	V _{CC} /2	30 pF	1 KΩ
2.5V ± 0.2V	V _{CC}	≤2ns	V _{CC} /2	30 pF	500 Ω
2.7V	V _{CC}	≤2.5ns	1.5V	50 pF	500 Ω
3.3V ± 0.3V	3.0V	≤2.5ns	1.5V	50 pF	500 Ω
5.0V ± 0.5V	V _{CC}	≤2.5ns	V _{CC} /2	50 pF	500 Ω

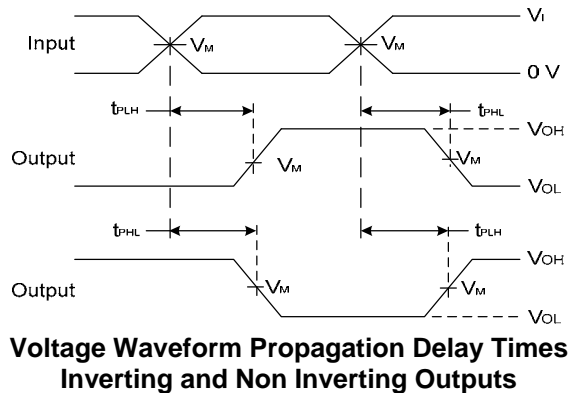
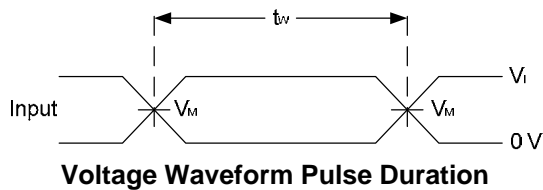
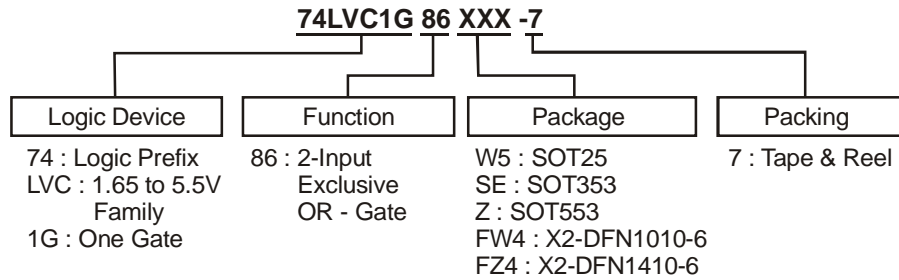

Figure 1. Load Circuit and Voltage Waveforms

- Notes:
- A. Includes test lead and test apparatus capacitance.
 - B. All pulses are supplied at pulse repetition rate ≤ 10 MHz.
 - C. Inputs are measured separately one transition per measurement.
 - D. t_{PLH} and t_{PHL} are the same as t_{PD}.

Ordering Information



Device	Package Code	Packaging (Note 6)	7" Tape and Reel	
			Quantity	Part Number Suffix
74LVC1G86W5-7	W5	SOT25	3000/Tape & Reel	-7
74LVC1G86SE-7	SE	SOT353	3000/Tape & Reel	-7
74LVC1G86Z-7	Z	SOT553	4000/Tape & Reel	-7
74LVC1G86FW4-7	FW4	X2-DFN1010-6	5000/Tape & Reel	-7
74LVC1G86FZ4-7	FZ4	X2-DFN1410-6	5000/Tape & Reel	-7

Notes: 5. Pad layout as shown on Diodes Inc. suggested pad layout document AP02001, which can be found on our website at <http://www.diodes.com/datasheets/ap02001.pdf>
6. The taping orientation is located on our website at <http://www.diodes.com/datasheets/ap02007.pdf>

Marking Information

(1) SOT25, SOT353 and SOT553

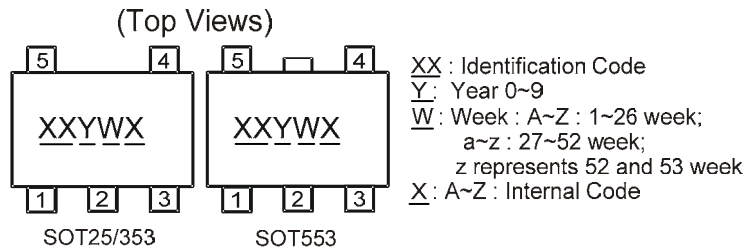

Part Number	Package	Identification Code
74LVC1G86W5	SOT25	UX
74LVC1G86SE	SOT353	UX
74LVC1G86Z	SOT553	UX

(3) X2-DFN1010-6 and X2-DFN1410-6

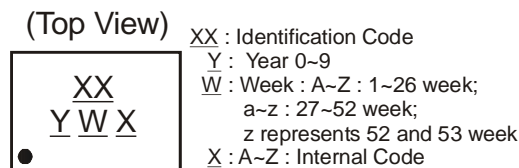

Part Number	Package	Identification Code
74LVC1G86FW4	X2-DFN1010-6	UX
74LVC1G86FZ4	X2-DFN1410-6	UX

Package Outline Dimensions (All Dimensions in mm)

(1) Package Type: SOT25

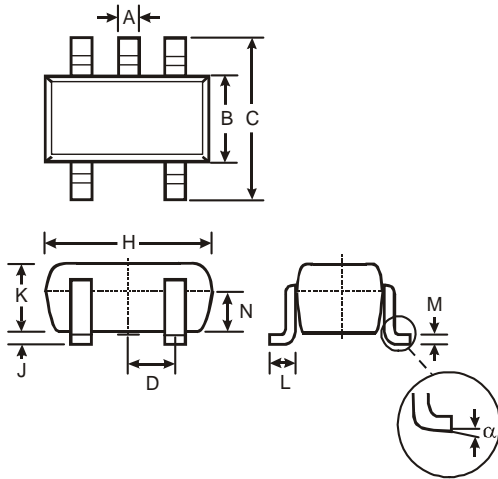

SOT25			
Dim	Min	Max	Typ
A	0.35	0.50	0.38
B	1.50	1.70	1.60
C	2.70	3.00	2.80
D	—	—	0.95
H	2.90	3.10	3.00
J	0.013	0.10	0.05
K	1.00	1.30	1.10
L	0.35	0.55	0.40
M	0.10	0.20	0.15
N	0.70	0.80	0.75
α	0°	8°	—
All Dimensions in mm			

(2) Package Type: SOT353

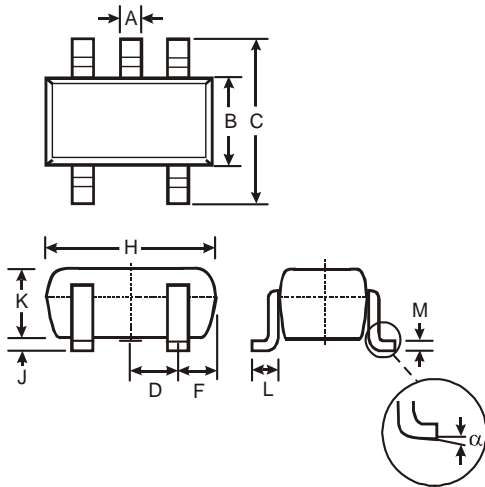

SOT353		
Dim	Min	Max
A	0.10	0.30
B	1.15	1.35
C	2.00	2.20
D	0.65 Typ	
F	0.40	0.45
H	1.80	2.20
J	0	0.10
K	0.90	1.00
L	0.25	0.40
M	0.10	0.22
α	0°	8°
All Dimensions in mm		

(3) Package Type: SOT553



SOT553			
Dim	Min	Max	Typ
A	0.55	0.62	0.60
b	0.15	0.30	0.20
c	0.10	0.18	0.15
D	1.50	1.70	1.60
E	1.55	1.70	1.60
E1	1.10	1.25	1.20
e	0.50 BSC		
e1	1.00 BSC		
F	0.00	0.10	—
L	0.10	0.30	0.20
α	6°	8°	7°
All Dimensions in mm			

Package Outline Dimensions (cont.)

(4) Package Type X2-DFN1010-6

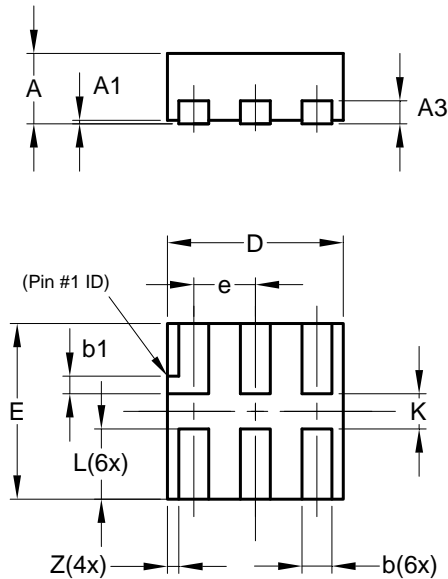

X2-DFN1010-6			
Dim	Min	Max	Typ
A	—	0.40	0.39
A1	0.00	0.05	0.02
A3	—	—	0.13
b	0.14	0.20	0.17
b1	0.05	0.15	0.10
D	0.95	1.05	1.00
E	0.95	1.05	1.00
e	—	—	0.35
L	0.35	0.45	0.40
K	0.15	—	—
Z	—	—	0.065
All Dimensions in mm			

(5) Package Type: X2-DFN1410-6

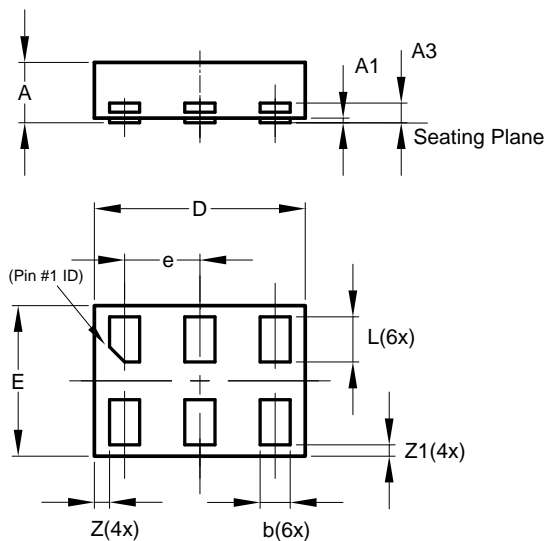

X2-DFN1410-6			
Dim	Min	Max	Typ
A	—	0.40	0.39
A1	0.00	0.05	0.02
A3	—	—	0.13
b	0.15	0.25	0.20
D	1.35	1.45	1.40
E	0.95	1.05	1.00
e	—	—	0.50
L	0.25	0.35	0.30
Z	—	—	0.10
Z1	0.045	0.105	0.075
All Dimensions in mm			

Suggested Pad Layout

(1) Package Type: SOT25

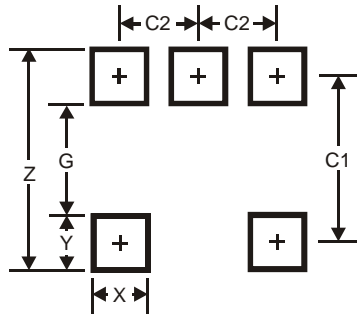

Dimensions	Value (in mm)
Z	3.20
G	1.60
X	0.55
Y	0.80
C1	2.40
C2	0.95

(2) Package Type: SOT353

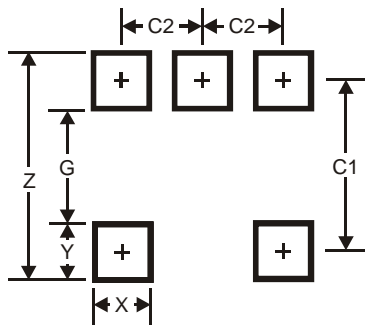

Dimensions	Value (in mm)
Z	2.5
G	1.3
X	0.42
Y	0.6
C1	1.9
C2	0.65

(3) Package Type: SOT553

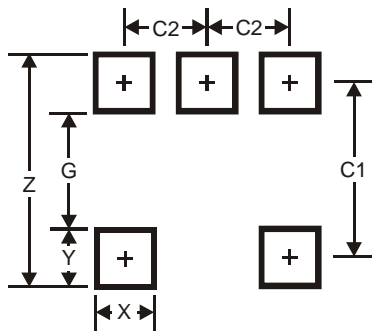

Dimensions	Value (in mm)
Z	2.2
G	1.2
X	0.375
Y	0.5
C1	1.7
C2	0.5

Suggested Pad Layout (cont.)

(4) Package Type X2-DFN1010-6

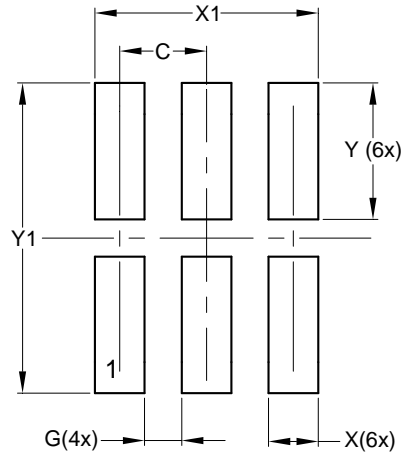

Dimensions	Value (in mm)
C	0.350
G	0.150
X	0.200
X1	0.900
Y	0.550
Y1	1.250

(5) Package Type: X2-DFN1410-6

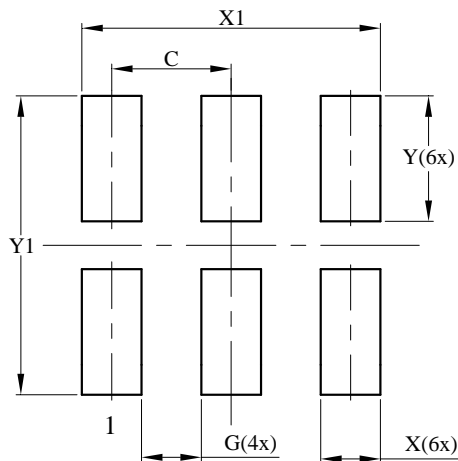

Dimensions	Value (in mm)
C	0.500
G	0.250
X	0.250
X1	1.250
Y	0.525
Y1	1.250

IMPORTANT NOTICE

DIODES INCORPORATED MAKES NO WARRANTY OF ANY KIND, EXPRESS OR IMPLIED, WITH REGARDS TO THIS DOCUMENT, INCLUDING, BUT NOT LIMITED TO, THE IMPLIED WARRANTIES OF MERCHANTABILITY AND FITNESS FOR A PARTICULAR PURPOSE (AND THEIR EQUIVALENTS UNDER THE LAWS OF ANY JURISDICTION).

Diodes Incorporated and its subsidiaries reserve the right to make modifications, enhancements, improvements, corrections or other changes without further notice to this document and any product described herein. Diodes Incorporated does not assume any liability arising out of the application or use of this document or any product described herein; neither does Diodes Incorporated convey any license under its patent or trademark rights, nor the rights of others. Any Customer or user of this document or products described herein in such applications shall assume all risks of such use and will agree to hold Diodes Incorporated and all the companies whose products are represented on Diodes Incorporated website, harmless against all damages.

Diodes Incorporated does not warrant or accept any liability whatsoever in respect of any products purchased through unauthorized sales channel.

Should Customers purchase or use Diodes Incorporated products for any unintended or unauthorized application, Customers shall indemnify and hold Diodes Incorporated and its representatives harmless against all claims, damages, expenses, and attorney fees arising out of, directly or indirectly, any claim of personal injury or death associated with such unintended or unauthorized application.

Products described herein may be covered by one or more United States, international or foreign patents pending. Product names and markings noted herein may also be covered by one or more United States, international or foreign trademarks.

LIFE SUPPORT

Diodes Incorporated products are specifically not authorized for use as critical components in life support devices or systems without the express written approval of the Chief Executive Officer of Diodes Incorporated. As used herein:

A. Life support devices or systems are devices or systems which:

1. are intended to implant into the body, or
2. support or sustain life and whose failure to perform when properly used in accordance with instructions for use provided in the labeling can be reasonably expected to result in significant injury to the user.

B. A critical component is any component in a life support device or system whose failure to perform can be reasonably expected to cause the failure of the life support device or to affect its safety or effectiveness.

Customers represent that they have all necessary expertise in the safety and regulatory ramifications of their life support devices or systems, and acknowledge and agree that they are solely responsible for all legal, regulatory and safety-related requirements concerning their products and any use of Diodes Incorporated products in such safety-critical, life support devices or systems, notwithstanding any devices- or systems-related information or support that may be provided by Diodes Incorporated. Further, Customers must fully indemnify Diodes Incorporated and its representatives against any damages arising out of the use of Diodes Incorporated products in such safety-critical, life support devices or systems.

Copyright © 2012, Diodes Incorporated

www.diodes.com

Компания «Океан Электроники» предлагает заключение долгосрочных отношений при поставках импортных электронных компонентов на взаимовыгодных условиях!

Наши преимущества:

- Поставка оригинальных импортных электронных компонентов напрямую с производств Америки, Европы и Азии, а так же с крупнейших складов мира;
- Широкая линейка поставок активных и пассивных импортных электронных компонентов (более 30 млн. наименований);
- Поставка сложных, дефицитных, либо снятых с производства позиций;
- Оперативные сроки поставки под заказ (от 5 рабочих дней);
- Экспресс доставка в любую точку России;
- Помощь Конструкторского Отдела и консультации квалифицированных инженеров;
- Техническая поддержка проекта, помощь в подборе аналогов, поставка прототипов;
- Поставка электронных компонентов под контролем ВП;
- Система менеджмента качества сертифицирована по Международному стандарту ISO 9001;
- При необходимости вся продукция военного и аэрокосмического назначения проходит испытания и сертификацию в лаборатории (по согласованию с заказчиком);
- Поставка специализированных компонентов военного и аэрокосмического уровня качества (Xilinx, Altera, Analog Devices, Intersil, Interpoint, Microsemi, Actel, Aeroflex, Peregrine, VPT, Syfer, Eurofarad, Texas Instruments, MS Kennedy, Miteq, Cobham, E2V, MA-COM, Hittite, Mini-Circuits, General Dynamics и др.);

Компания «Океан Электроники» является официальным дистрибьютором и эксклюзивным представителем в России одного из крупнейших производителей разъемов военного и аэрокосмического назначения «JONHON», а так же официальным дистрибьютором и эксклюзивным представителем в России производителя высокотехнологичных и надежных решений для передачи СВЧ сигналов «FORSTAR».



JONHON

«JONHON» (основан в 1970 г.)

Разъемы специального, военного и аэрокосмического назначения:

(Применяются в военной, авиационной, аэрокосмической, морской, железнодорожной, горно- и нефтедобывающей отраслях промышленности)

«FORSTAR» (основан в 1998 г.)

ВЧ соединители, коаксиальные кабели,
кабельные сборки и микроволновые компоненты:

(Применяются в телекоммуникациях гражданского и специального назначения, в средствах связи, РЛС, а так же военной, авиационной и аэрокосмической отраслях промышленности).



Телефон: 8 (812) 309-75-97 (многоканальный)

Факс: 8 (812) 320-03-32

Электронная почта: ocean@oceanchips.ru

Web: <http://oceanchips.ru/>

Адрес: 198099, г. Санкт-Петербург, ул. Калинина, д. 2, корп. 4, лит. А