



MICROCHIP

**MCP1630 Automotive Input
Triple Output Converter
Demo Board
User's Guide**

Note the following details of the code protection feature on Microchip devices:

- Microchip products meet the specification contained in their particular Microchip Data Sheet.
- Microchip believes that its family of products is one of the most secure families of its kind on the market today, when used in the intended manner and under normal conditions.
- There are dishonest and possibly illegal methods used to breach the code protection feature. All of these methods, to our knowledge, require using the Microchip products in a manner outside the operating specifications contained in Microchip's Data Sheets. Most likely, the person doing so is engaged in theft of intellectual property.
- Microchip is willing to work with the customer who is concerned about the integrity of their code.
- Neither Microchip nor any other semiconductor manufacturer can guarantee the security of their code. Code protection does not mean that we are guaranteeing the product as "unbreakable."

Code protection is constantly evolving. We at Microchip are committed to continuously improving the code protection features of our products. Attempts to break Microchip's code protection feature may be a violation of the Digital Millennium Copyright Act. If such acts allow unauthorized access to your software or other copyrighted work, you may have a right to sue for relief under that Act.

Information contained in this publication regarding device applications and the like is provided only for your convenience and may be superseded by updates. It is your responsibility to ensure that your application meets with your specifications. MICROCHIP MAKES NO REPRESENTATIONS OR WARRANTIES OF ANY KIND WHETHER EXPRESS OR IMPLIED, WRITTEN OR ORAL, STATUTORY OR OTHERWISE, RELATED TO THE INFORMATION, INCLUDING BUT NOT LIMITED TO ITS CONDITION, QUALITY, PERFORMANCE, MERCHANTABILITY OR FITNESS FOR PURPOSE. Microchip disclaims all liability arising from this information and its use. Use of Microchip devices in life support and/or safety applications is entirely at the buyer's risk, and the buyer agrees to defend, indemnify and hold harmless Microchip from any and all damages, claims, suits, or expenses resulting from such use. No licenses are conveyed, implicitly or otherwise, under any Microchip intellectual property rights.

Trademarks

The Microchip name and logo, the Microchip logo, Accuron, dsPIC, KEELOQ, microID, MPLAB, PIC, PICmicro, PICSTART, PRO MATE, PowerSmart, rfPIC and SmartShunt are registered trademarks of Microchip Technology Incorporated in the U.S.A. and other countries.

AmpLab, FilterLab, Migratable Memory, MXDEV, MXLAB, SEEVAL, SmartSensor and The Embedded Control Solutions Company are registered trademarks of Microchip Technology Incorporated in the U.S.A.

Analog-for-the-Digital Age, Application Maestro, CodeGuard, dsPICDEM, dsPICDEM.net, dsPICworks, ECAN, ECONOMONITOR, FanSense, FlexROM, fuzzyLAB, In-Circuit Serial Programming, ICSP, ICEPIC, Linear Active Thermistor, Mindi, MiWi, MPASM, MPLIB, MPLINK, PICKIT, PICDEM, PICDEM.net, PICLAB, PICTail, PowerCal, PowerInfo, PowerMate, PowerTool, REAL ICE, rFLAB, rfPICDEM, Select Mode, Smart Serial, SmartTel, Total Endurance, UNI/O, WiperLock and ZENA are trademarks of Microchip Technology Incorporated in the U.S.A. and other countries.

SQTP is a service mark of Microchip Technology Incorporated in the U.S.A.

All other trademarks mentioned herein are property of their respective companies.

© 2006, Microchip Technology Incorporated, Printed in the U.S.A., All Rights Reserved.

 Printed on recycled paper.

QUALITY MANAGEMENT SYSTEM
CERTIFIED BY DNV
== ISO/TS 16949:2002 ==

Microchip received ISO/TS-16949:2002 certification for its worldwide headquarters, design and wafer fabrication facilities in Chandler and Tempe, Arizona, Gresham, Oregon and Mountain View, California. The Company's quality system processes and procedures are for its PICmicro® 8-bit MCUs, KEELOQ® code hopping devices, Serial EEPROMs, microperipherals, nonvolatile memory and analog products. In addition, Microchip's quality system for the design and manufacture of development systems is ISO 9001:2000 certified.



MCP1630 AUTOMOTIVE INPUT TRIPLE OUTPUT CONVERTER DEMO BOARD USER'S GUIDE

Table of Contents

Preface	1
Introduction.....	1
Document Layout	1
Conventions Used in this Guide	2
Recommended Reading.....	2
The Microchip Web Site	3
Customer Support	3
Document Revision History	3
Chapter 1. Product Overview	5
1.1 Introduction	5
1.2 What is the MCP1630 Automotive Input Triple Output Converter Demo Board?	6
1.3 What the MCP1630 Automotive Input Triple Output Converter Demo Board kit includes	6
Chapter 2. Installation and Operation	7
2.1 Introduction	7
2.2 Features	7
2.3 Getting Started	8
Appendix A. Schematic and Layouts	11
A.1 Introduction	11
A.2 Board – Schematic	12
A.3 Board – Top Silk Layer	13
A.4 Board – Top Metal Layer	14
A.5 Board – Bottom Metal Layer	15
Appendix B. Bill Of Materials (BOM)	17
Appendix C. Demo Board Firmware	19
C.1 Device Firmware	19
Worldwide Sales and Service	20

NOTES:



MCP1630 AUTOMOTIVE INPUT TRIPLE OUTPUT CONVERTER DEMO BOARD USER'S GUIDE

Preface

NOTICE TO CUSTOMERS

All documentation becomes dated, and this manual is no exception. Microchip tools and documentation are constantly evolving to meet customer needs, so some actual dialogs and/or tool descriptions may differ from those in this document. Please refer to our web site (www.microchip.com) to obtain the latest documentation available.

Documents are identified with a "DS" number. This number is located on the bottom of each page, in front of the page number. The numbering convention for the DS number is "DSXXXXA", where "XXXX" is the document number and "A" is the revision level of the document.

For the most up-to-date information on development tools, see the MPLAB® IDE on-line help. Select the Help menu, and then Topics to open a list of available on-line help files.

INTRODUCTION

This chapter contains general information that will be useful to know before using the MCP1630 Automotive Input Triple Output Converter Demo Board. Items discussed in this chapter include:

- Document Layout
- Conventions Used in this Guide
- Recommended Reading
- The Microchip Web Site
- Customer Support
- Document Revision History

DOCUMENT LAYOUT

This document describes how to use the MCP1630 Automotive Input Triple Output Converter Demo Board. The manual layout is as follows:

- **Chapter 1. "Product Overview"** – Important information about the MCP1630 Automotive Input Triple Output Converter Demo Board.
- **Chapter 2. "Installation and Operation"** – Includes instructions on how to get started with this user's guide and a description of the user's guide.
- **Appendix A. "Schematic and Layouts"** – Shows the schematic and layout diagrams for the MCP1630 Automotive Input Triple Output Converter Demo Board.
- **Appendix B. "Bill Of Materials (BOM)"** – Lists the parts used to build the MCP1630 Automotive Input Triple Output Converter Demo Board.
- **Appendix C. "Demo Board Firmware"** – Provides information about the application firmware and where the source code can be found.

CONVENTIONS USED IN THIS GUIDE

This manual uses the following documentation conventions:

DOCUMENTATION CONVENTIONS

Description	Represents	Examples
Arial font:		
Italic characters	Referenced books	<i>MPLAB[®] IDE User's Guide</i>
	Emphasized text	...is the <i>only</i> compiler...
Initial caps	A window	the Output window
	A dialog	the Settings dialog
	A menu selection	select Enable Programmer
Quotes	A field name in a window or dialog	"Save project before build"
Underlined, italic text with right angle bracket	A menu path	<u><i>File>Save</i></u>
Bold characters	A dialog button	Click OK
	A tab	Click the Power tab
'bnnnn	A binary number where <i>n</i> is a digit	'b00100, 'b10
Text in angle brackets < >	A key on the keyboard	Press <Enter>, <F1>
Courier font:		
Plain Courier	Sample source code	#define START
	Filenames	autoexec.bat
	File paths	c:\mcc18\h
	Keywords	_asm, _endasm, static
	Command-line options	-Opa+, -Opa-
	Bit values	0, 1
Italic Courier	A variable argument	<i>file.o</i> , where <i>file</i> can be any valid filename
0xnnnn	A hexadecimal number where <i>n</i> is a hexadecimal digit	0xFFFF, 0x007A
Square brackets []	Optional arguments	mcc18 [options] <i>file</i> [options]
Curly brackets and pipe character: { }	Choice of mutually exclusive arguments; an OR selection	errorlevel {0 1}

RECOMMENDED READING

This user's guide describes how to use MCP1630 Automotive Input Triple Output Converter Demo Board. The following Microchip documents are available on our web site (www.microchip.com) and recommended as supplemental reference resources.

MCP1630/MCP1630V Data Sheet, "High-Speed, Microcontroller-Adaptable, Pulse Width Modulator" (DS21896)

This data sheet provides detailed information regarding the MCP1630/MCP1630V, product family.

PIC12F683 Data Sheet, "8-Pin Flash-Based, 8-Bit CMOS Microcontrollers with Nano Watt Technology" (DS41211)

This data sheet provides detailed information regarding the PIC12F683 product family

THE MICROCHIP WEB SITE

Microchip provides online support via our web site at www.microchip.com. This web site is used as a means to make files and information easily available to customers. Accessible by using your favorite Internet browser, the web site contains the following information:

- **Product Support** – Data sheets and errata, application notes and sample programs, design resources, user's guides and hardware support documents, latest software releases and archived software
- **General Technical Support** – Frequently Asked Questions (FAQs), technical support requests, online discussion groups, Microchip consultant program member listing
- **Business of Microchip** – Product selector and ordering guides, latest Microchip press releases, listing of seminars and events, listings of Microchip sales offices, distributors and factory representatives

CUSTOMER SUPPORT

Users of Microchip products can receive assistance through several channels:

- Distributor or Representative
- Local Sales Office
- Field Application Engineer (FAE)
- Technical Support
- Development Systems Information Line

Customers should contact their distributor, representative or field application engineer for support. Local sales offices are also available to help customers. A listing of sales offices and locations is included in the back of this document.

Technical support is available through the web site at: <http://support.microchip.com>

DOCUMENT REVISION HISTORY

Revision A (September 2006)

- Initial Release of this Document.

NOTES:

Chapter 1. Product Overview

1.1 INTRODUCTION

The proliferation of distributed power supplies is expected to accelerate their use in future generation cars and continue to incorporate increasingly complex electronic systems. Distributed power supplies or "point-of-load" power supplies are being used increasingly through out. These power supply units (PSUs) are responsible for stepping up (or down) the input bus voltage, to power a multitude of electronic subsystems. Examples of these electronic systems are collision avoidance radar, adaptive cruise control, tire pressure monitoring, navigation systems, hands-free cellular phones, and other wireless connectivity.

The majority of mid- to high-end automobiles produced today come with a DVD-based GPS navigation system as standard equipment. However, designing a power supply to handle all the different voltage rails within such a system can prove to be as complex as designing the power-supply system for a notebook PC. The 5V and 3.3V rails are typically the system bus. The 1.5V and 1.2V rails are used to power the CPU and DSP-core voltages, respectively. The power levels of these two rails are usually between 3W and 5W each.

Automotive subsystems with their inherent high voltage transients and high efficiency requirements place increasing demands on power supply designs. These supplies must provide high power, high efficiency and low noise from a very compact footprint and must maintain a high efficiency over a wide range of operational input voltages.

The MCP1630/MCP1630V High-Speed, Microcontroller-Adaptable Pulse Width Modulator is capable of maintaining output regulation with no adverse effects on system performance or reliability. The MCP1630 Automotive Input Triple Output Converter Demo Board provides a better choice for automotive application design and providing high efficiency and also providing a tight Line, Load and Cross regulation for the three outputs.

This chapter covers the following topics.

- What is the MCP1630 Automotive Input Triple Output Converter Demo Board?
- What the MCP1630 Automotive Input Triple Output Converter Demo Board Kit includes.

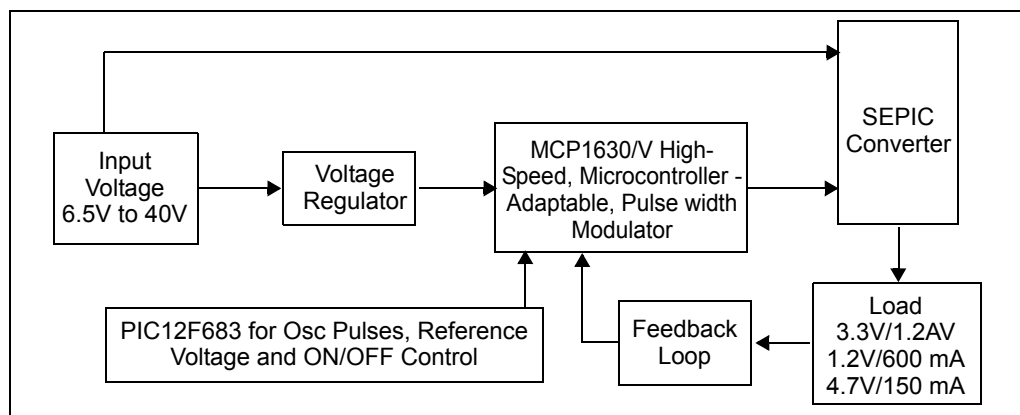

FIGURE 1-1: MCP1630 Automotive Input Triple Output Converter Demo Board Block Diagram.

1.2 WHAT IS THE MCP1630 AUTOMOTIVE INPUT TRIPLE OUTPUT CONVERTER DEMO BOARD?

The MCP1630 Automotive Input Triple Output Converter Demo Board demonstrates the use of a SEPIC topology for Automotive applications. The board also serves as a platform to evaluate the MCP1630 device.

The MCP1630 inputs were developed to be easily attached to the I/O of a MCU. The MCU supplies the oscillator pulses and reference voltage (V_{REF}) to the MCP1630 to provide the most flexible and adaptable power system. The power system switching frequency and maximum duty cycle are set using the I/O of the MCU. The reference input to high speed PWM can be external, a D/A Converter (DCA) output or as simple as an I/O output from the MCU. This enables the power system to adapt to, many external signals and variables in order to optimize performance and facilitate calibration.

This board utilizes Microchip's MCP1630 (High-Speed, Microcontroller-Adaptable, PWM MSOP8) integrated with PIC12F683 (Flash MCU SOIC8) in automotive application. Under normal operation, the supply lines can range between 6.5V - 40V. The converter is capable of delivering three different output voltages of 3.3V at 1.2A load current, 1.2V at 600 mA load current and 4.7V at 150 mA load current, respectively. The Line regulation, Load regulation and Cross regulation is within $\pm 5\%$ on V_{OUT1} , $\pm 5\%$ on V_{OUT2} and $\pm 10\%$ on V_{OUT3} for the variation in load from 50% to 100%.

1.3 WHAT THE MCP1630 AUTOMOTIVE INPUT TRIPLE OUTPUT CONVERTER DEMO BOARD KIT INCLUDES

This MCP1630 Automotive Input Triple Output Converter Demo Board Kit includes:

- MCP1630 Automotive Input Triple Output Converter Demo Board (102-00067)
- Analog and Interface Products Demonstration Boards CD-ROM (DS21912)
 - MCP1630 Automotive Input Triple Output Converter Demo Board User's Guide (DS51627)



MCP1630 AUTOMOTIVE INPUT TRIPLE OUTPUT CONVERTER DEMO BOARD USER'S GUIDE

Chapter 2. Installation and Operation

2.1 INTRODUCTION

The MCP1630 Automotive Input Triple Output Converter Demo Board demonstrates Microchip's high speed pulse width modulator (PWM) used for Automotive application. When used in conjunction with a microcontroller, the MCP1630 will control the power system duty cycle to provide regulated output voltage. The PIC12F683 microcontroller is used to provide oscillator pulses at switching frequency of 250 kHz and set maximum duty cycle. The MCP1630 generates duty cycle based on various external inputs. External signals include the input oscillator pulses from PIC12F683, the reference voltage and the feed back voltage. The output signal is a square-wave pulse given to drive the MOSFET.

The PIC12F683 microcontroller is programmable, allowing the user to modify or develop their own firmware routines to further evaluate the MCP1630 in this application.

2.2 FEATURES

The MCP1630 Automotive Input Triple Output Converter Demo Board has the following features:

- Compact size for a Triple output Converter
- Wide Input voltage range from 6.5V to 40V
- Programmable output voltage and ON/OFF control using the PIC microcontroller
- Provide line regulation, load regulation and cross regulation of $\pm 5\%$ on V_{OUT1} (3.3V), $\pm 5\%$ on V_{OUT2} (1.2V) and $\pm 10\%$ on V_{OUT3} (4.7V) for load variation from 50% to 100%
- High efficiency over entire operating input voltage range
- PIC12F683 is used to generate reference Voltage and Oscillator signal at 250 kHz frequency at maximum duty cycle
- Proprietary features can be added by modifying the firmware contained in the PIC12F683
- Factory programmed source code is available

2.3 GETTING STARTED

The MCP1630 Automotive Input Triple Output Converter Demo Board is fully assembled and tested for Automotive Input. The board requires the use of an external input voltage source (+6.5V to 40V) and external load for three outputs.

2.3.1 Power Input and Output Connection

2.3.1.1 POWERING THE MCP1630 AUTOMOTIVE INPUT TRIPLE OUTPUT CONVERTER DEMO BOARD

1. Connect the positive side of the input source (+) to TP2. Connect the negative or return side (-) of input source to TP1. Refer to figure 2-1. The input voltage should be limited from 6.5V to 40V range. As the input voltage is applied and the system powers up, the firmware program of the PIC12F683 device will initialize and help the converter remain in low-power sleep mode (<0.1 uA) until the SW1 push button is pressed by the user.
2. Once the SW1 push button is pressed, the MCP1630 Automotive Input Triple Output Converter Demo Board is powered on delivering the three output voltages of 3.3V at 1.2A (Maximum current), 1.2V at 600 mA (Maximum current) and 4.7V at 150 mA (Maximum current) respectively.
3. Again, a subsequent pressing of the SW1 push button during normal operation of the MCP1630 Automotive Input Triple Output Converter Demo Board will power-off the converter.

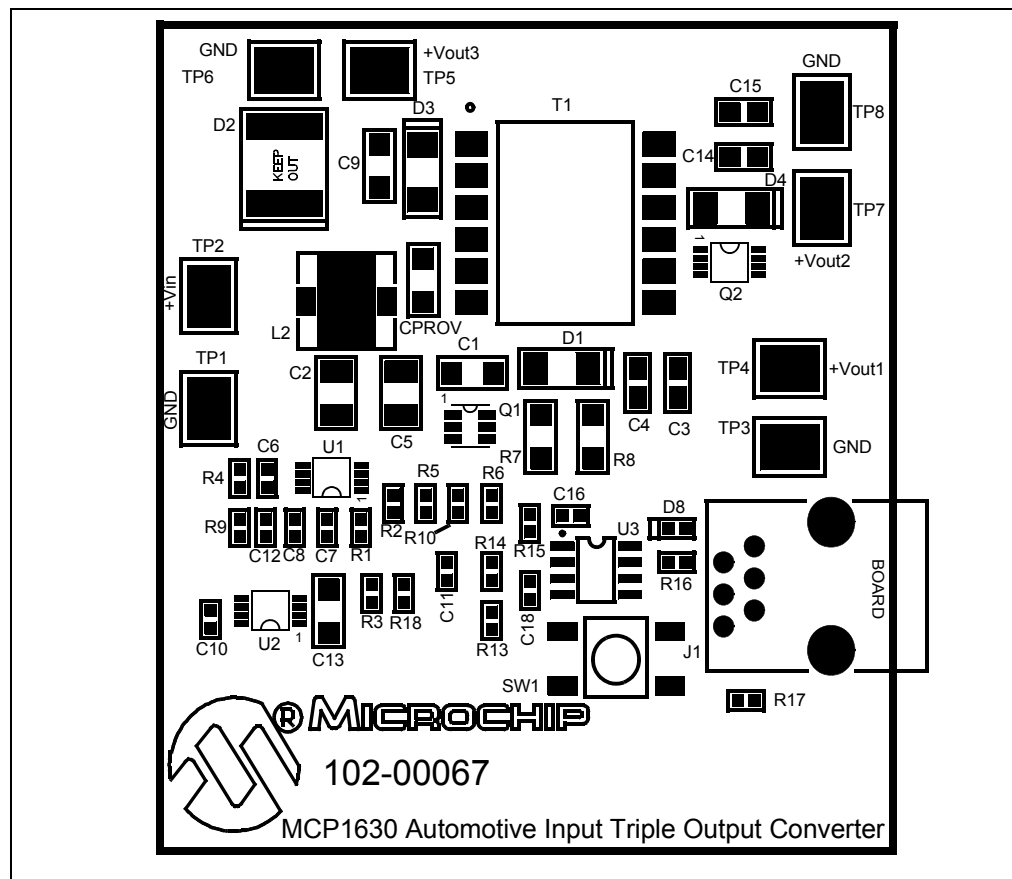

FIGURE 2-1: Setup Configuration Diagram.

2.3.1.2 APPLYING LOAD TO MCP1630 AUTOMOTIVE INPUT TRIPLE OUTPUT CONVERTER DEMO BOARD

A variable resistive load can be used to verify the line regulation, load regulation and cross regulation. The load resistance for the three outputs can be connected accordingly. Note that the currents should not exceed the maximum current limit of individual outputs i.e: 1.2A (maximum) for V_{OUT1} , 600 mA (maximum) for V_{OUT2} and 150 mA (maximum) for V_{OUT3} , respectively. The load resistance is connected between the test points TP3 and TP4 for V_{OUT1} , between test points TP7 and TP8 for V_{OUT2} and between test points TP5 and TP6 for V_{OUT3} . To measure the output voltage, connect the common point of multimeter to TP3 and the positive terminal to TP4 for V_{OUT1} . Similarly, to measure the output voltages of V_{OUT2} and V_{OUT3} , connect the common point of multimeter to TP8 for V_{OUT2} and TP6 for V_{OUT3} and the positive terminal to TP7 for V_{OUT2} and TP5 for V_{OUT3} .

The load regulation and cross regulation can be verified by varying the load from 50% to 100%, with different combination of loads on all the outputs. Similarly, by varying the line voltage from 6.5V to 40V and checking the output voltage, the line regulation can be calculated.

Evaluating the Application

The best way to evaluate the MCP1630 Automotive Input Triple Output Converter Demo Board is to dig into the circuit. Measure voltages and currents with a DVM and probe the board with an oscilloscope.

The firmware program in the PIC12F683 can also be edited to modify the operation of the application.

Firmware

The PIC12F683 comes pre programmed with firmware to operate the system as described above. The file listing and firmware flow diagram are shown in **Appendix C. "Demo Board Firmware"**.

The program is fairly simple and straight forward. There is an initialization routine at the beginning of the program.

The internal oscillator clock is set to 8 MHz. The TRISIO is configured to set GP2 (Oscillator pulses to the MCP1630) and GP4 (V_{REF} Voltage to MCP1630) as an output port and GP3 (Switch SW1) as Input Port. The OPTION register is configured to wake-up on Port pin change of GP3.

The Capture/Compare/PWM (CCP) module contains a 16-bit register which can operate in PWM mode. The PWM period can be calculated by writing to the PR2 register. The PWM duty cycle is specified by writing to the CCPR1L register and to the CCP1CON <5:4> bits. Up to 10-bit resolution is available. The CCPR1L contains the eight MSBs and the CCP1CON <5:4> contains the two LSbs. This 10-bit value is represented by CCPR1L:CCP1CON<5:4>. The switching frequency is set to 250 kHz.

Upon powering on, the processor enters into SLEEP mode after the ports are initialized and registers configured. The processor wakes-up from SLEEP mode, if the Switch SW1 on GP3 is pressed.

Once the processor is on after the switch SW1 is pressed, the three output voltages of 3.3V, 1.2V and 4.7V are generated by set by generating V_{REF} voltage and the PWM signal. TMR0 is configured to generate the V_{REF} voltage.

During normal operation, a subsequent pressing of switch SW1 will make the converter to go into SLEEP mode.

The switch SW1 is used to perform a simple ON/OFF operation.

Programming

Header J1 is provided for in-circuit programming. This is an optional feature since the demo board comes preprogrammed with firmware to operate the system. The PIC12F683 can be reprogrammed with the Baseline Flash Microcontroller Programmer (BFMP)



MCP1630 AUTOMOTIVE INPUT TRIPLE OUTPUT CONVERTER DEMO BOARD USER'S GUIDE

Appendix A. Schematic and Layouts

A.1 INTRODUCTION

This appendix contains the following schematics and layouts for the MCP1630 Automotive Input Triple Output Converter Demo Board:

- Board – Schematic
- Board – Top Silk Layer
- Board – Top Metal Layer
- Board – Bottom Metal Layer

A.2 BOARD – SCHEMATIC

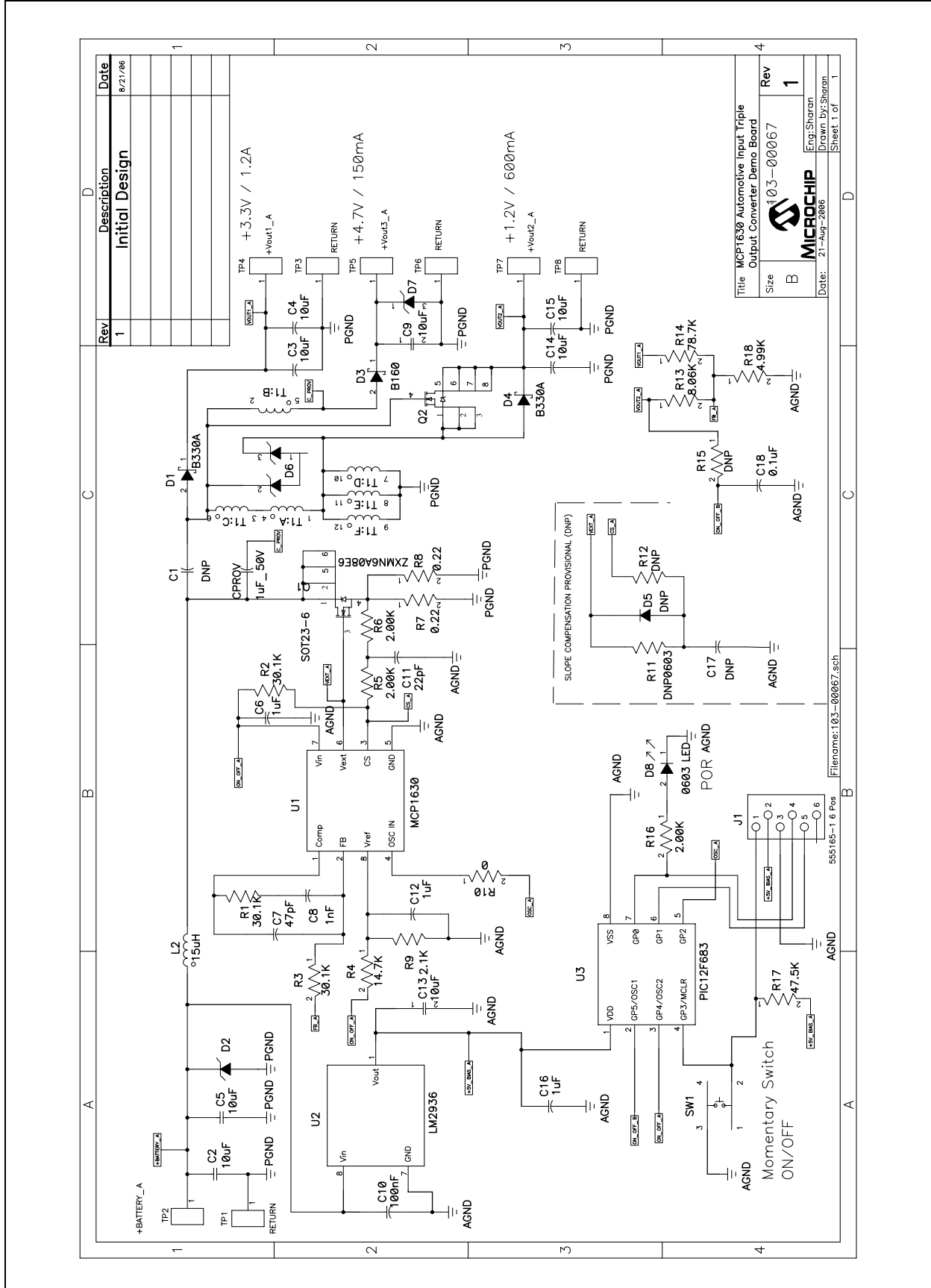

A.3 BOARD – TOP SILK LAYER

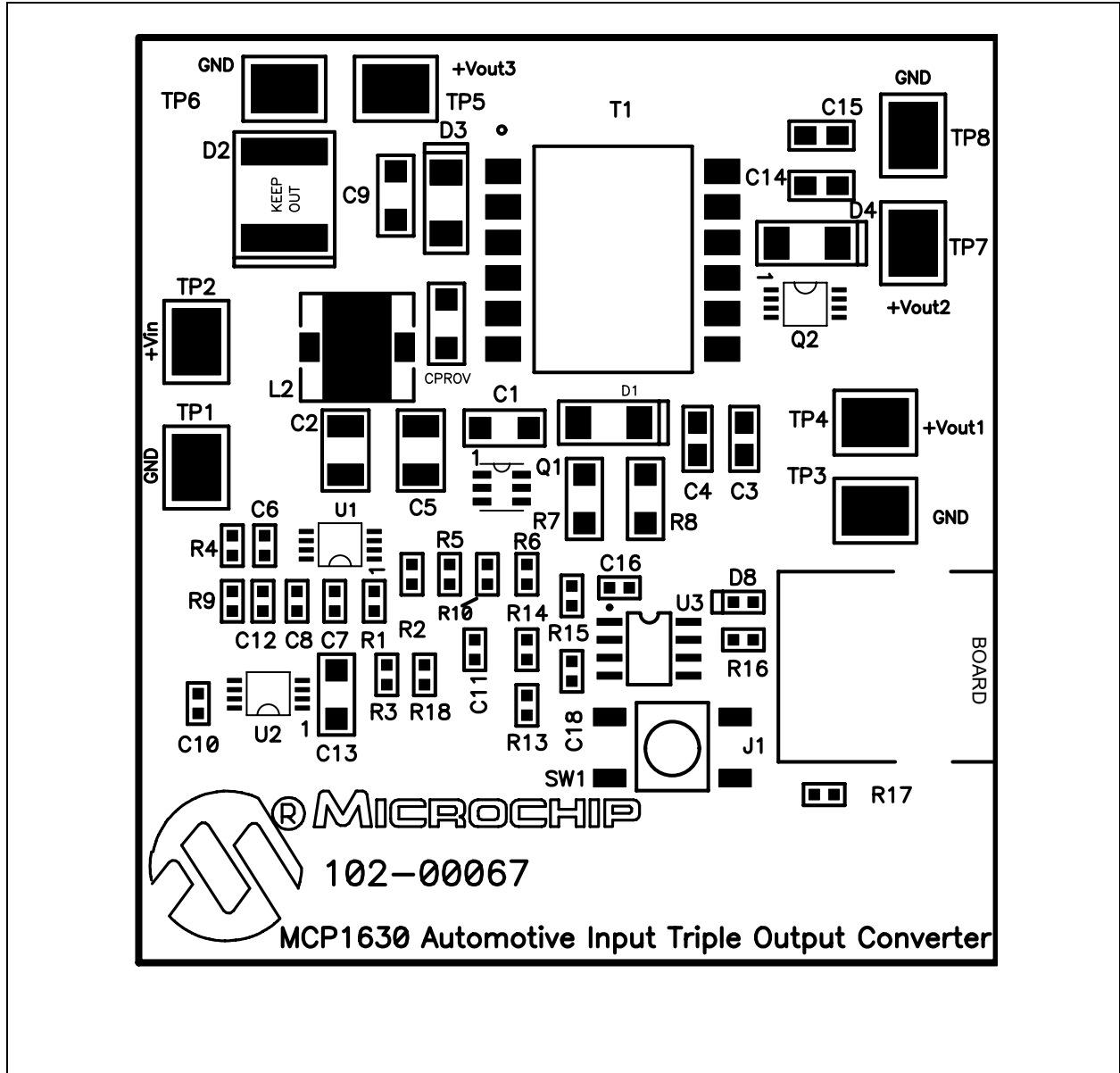

A.4 BOARD – TOP METAL LAYER

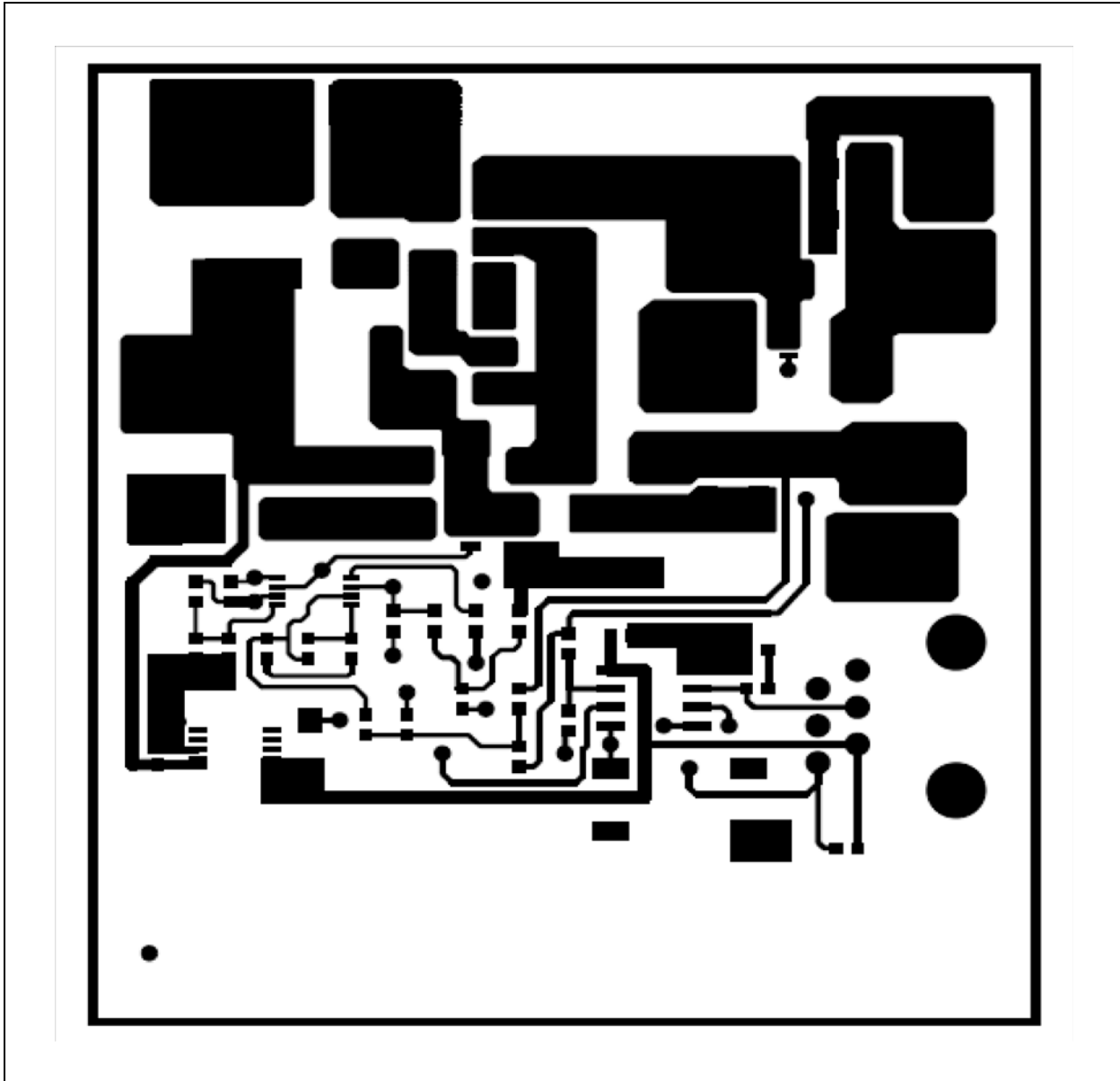

A.5 BOARD – BOTTOM METAL LAYER

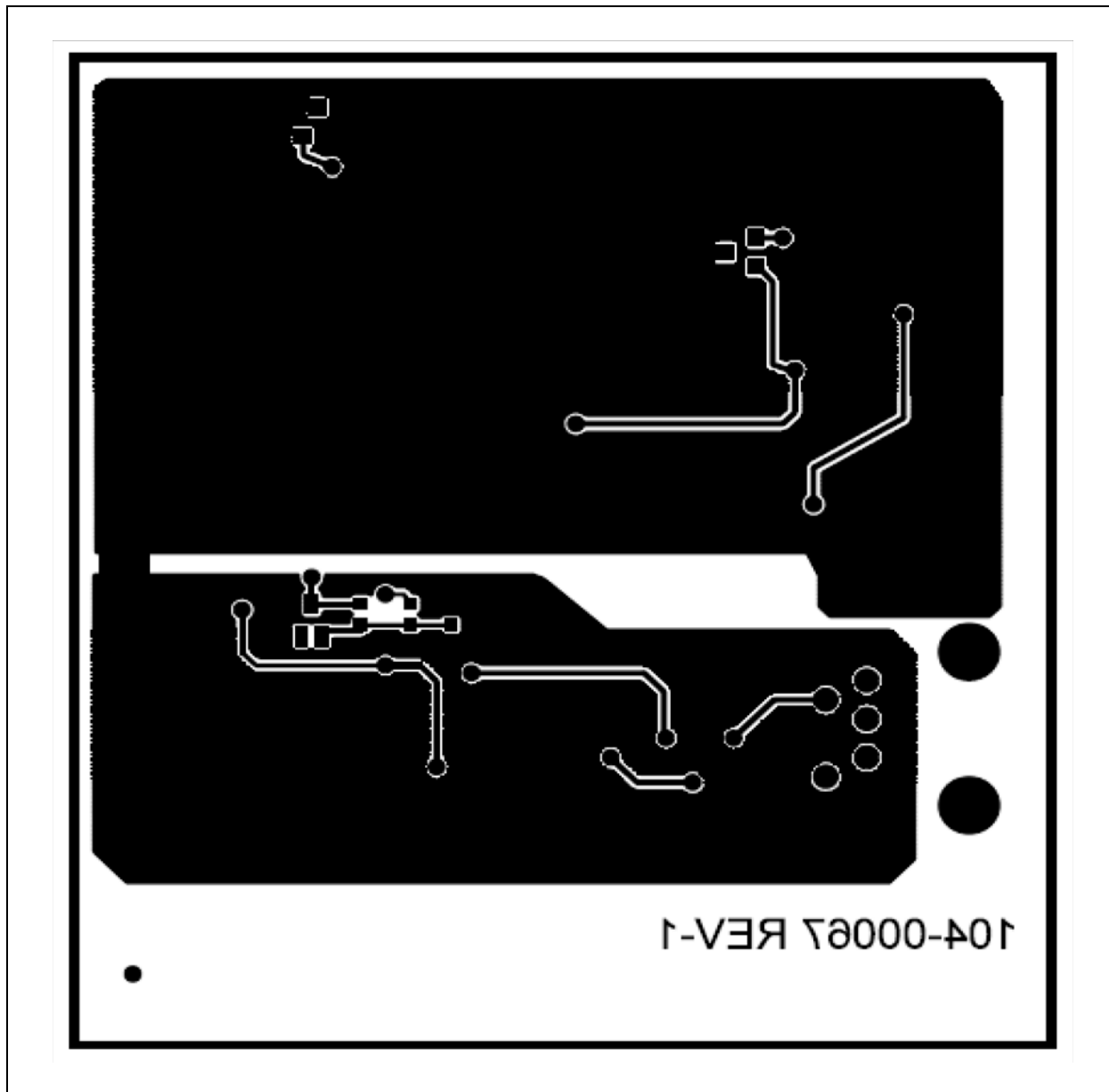

NOTES:



MCP1630 AUTOMOTIVE INPUT TRIPLE OUTPUT CONVERTER DEMO BOARD USER'S GUIDE

Appendix B. Bill Of Materials (BOM)

TABLE B-1: BILL OF MATERIALS (BOM)

Qty	Reference	Description	Manufacturer	Part Number
2	C1,C17	DNP	—	—
2	C2, C5	Cap 10UF 50V Ceramic F 1210	Panasonic® - ECG	ECJ-4YF1H106Z
5	C3, C4, C9,C14, C15	Cap 10UF 6.3V Ceramic X5R 0805	Panasonic - ECG	ECJ-2FB0J106M
2	C6, C16	Cap 1UF 10V Ceramic 0603 X5R	Panasonic - ECG	ECJ-1VB1A105K
1	C7	Cap Ceramic 47PF 50V 0603 SMD	Panasonic - ECG	ECJ-1VC1H470J
1	C8	Cap Ceramic 1000PF 50V NP0 0603	Panasonic - ECG	ECJ-1VC1H102J
1	C10	Cap .1UF 50V Ceramic Y5V 0603	Panasonic - ECG	ECJ-1VF1H104Z
1	C11	Cap Ceramic 22PF 50V 0603 SMD	Panasonic - ECG	ECJ-1VC1H220J
2	C12, C18	Cap .10UF 10V Ceramic X7R 0603	Kemet® Electronics Corp	C0603C104K8RACTU
1	C13	Cap 10UF 10V Ceramic 1206 X5R	Panasonic - ECG	ECJ-3YB1A106M
1	CPROV	Cap Cer 1UF 50V X7R 10% 1206	TDK Corporation	C3216X7R1H105K
2	D1, D4	Diode Schottky 30V 3A SMA	Diodes Inc	B330A-13
2	D2,D5	DNP		
1	D3	Diode Schottky 60V 1A SMA	Diodes Inc	B160-13
1	D6	Diode Zener Dual CA 18V SOT-23	Diodes Inc	AZ23C18-7
1	D7	Diode Zener 350MW 6.2V SOT23	Diodes Inc	BZX84C6V2-7-F
1	D8	LED 660NM Super Red Diff 0603SMD	Lumex® / Opto Components Inc	SML-LX0603SRW-TR
1	J1	Conn Mod Jack 6-6 R/A PCB 50AU	Tyco® Electronics/Amp	555165-1
1	L2	Inductor Shield PWR 15UH SMD	Coiltronics/Div of Cooper/Bussmann	DR74-150-R
1	Q1	MOSFET N-CH 60V 2.5A SOT-23-6	Zetex Inc	ZXMN6A08E6TA
1	Q2	MOSFET N-CH 20V 6A 8-MSOP	Zetex Inc	ZXMN2A02X8TA
3	R1, R2, R3	Res 30.1K Ohm 1/10W 1% 0603 SMD	Panasonic - ECG	ERJ-3EKF3012V
1	R4	RES 14.7K Ohm 1/10W 1% 0603 SMD	Panasonic - ECG	ERJ-3EKF1472V
4	R5, R6, R9, R16	Res 2.00K Ohm 1/10W 1% 0603 SMD	Panasonic - ECG	ERJ-3EKF2001V
2	R7,R8	Res 0.22 Ohm 1/4W 1% 1206 SMD	Panasonic - ECG	ERJ-8RQFR22V
1	R10	Res 10.0 Ohm 1/10W 1% 0603 SMD	Panasonic - ECG	ERJ-3EKF10R0V
3	R11, R12, R15	DNP	—	—
1	R13	Res 8.06K Ohm 1/10W 1% 0603 SMD	Panasonic - ECG	ERJ-3EKF8061V
1	R14	Res 78.7K Ohm 1/10W 1% 0603 SMD	Panasonic - ECG	ERJ-3EKF7872V
1	R17	Res 47.5K Ohm 1/10W 1% 0603 SMD	Panasonic - ECG	ERJ-3EKF4752V
1	R18	Res 4.99K Ohm 1/10W 1% 0603 SMD	Panasonic - ECG	ERJ-3EKF4991V
1	SW1	Switch Tact 6MM 260GF SMT	E-Switch	TL3301NF260QG

Note 1: The components listed in this Bill of Materials are representative of the PCB assembly. The released BOM used in manufacturing uses all RoHS-compliant components.

MCP1630 Automotive Input Triple Output Converter Demo Board User's Guide

TABLE B-1: BILL OF MATERIALS (BOM) (CONTINUED)

Qty	Reference	Description	Manufacturer	Part Number
8	TP1,TP2,TP3,TP4,TP5,TP6,TP7,TP8	PC Test point compact SMT	Keystone Electronics®	5016
1	T1	Inductor / Transformer 5.7uH SMD	Coiltronics/Div of Cooper/Bussmann	VP2-0116-R
1	U1	IC PWM HS MCU-Adaptable 8MSOP	Microchip Technology Inc	MCP1630-E/MS
1	U2	IC Regulator Ultra -LO 5V 8-MSOP	National Semiconductor®	LM2936MM-5.0
1	U3	IC MCU Flash 2KX14 8SOIC	Microchip Technology Inc	PIC12F683-I/SNG

Note 1: The components listed in this Bill of Materials are representative of the PCB assembly. The released BOM used in manufacturing uses all RoHS-compliant components.

Appendix C. Demo Board Firmware

C.1 DEVICE FIRMWARE

For the latest version of the MCP1630 Automotive Input Triple Output Converter Demo Board firmware, visit our web site at www.microchip.com.

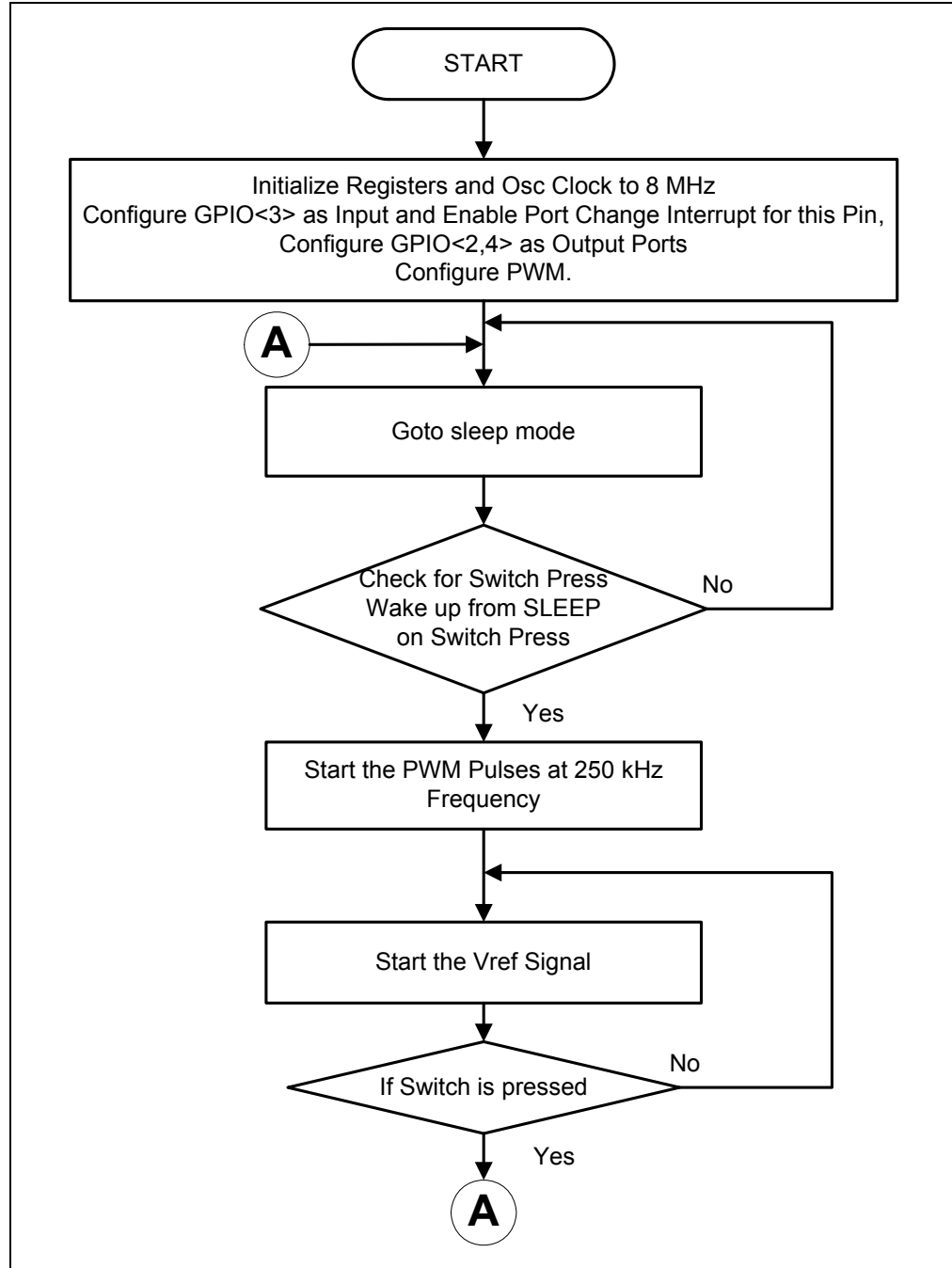

FIGURE C-1: Firmware Flowchart.



MICROCHIP

WORLDWIDE SALES AND SERVICE

AMERICAS

Corporate Office

2355 West Chandler Blvd.
Chandler, AZ 85224-6199
Tel: 480-792-7200
Fax: 480-792-7277
Technical Support:
<http://support.microchip.com>
Web Address:
www.microchip.com

Atlanta

Alpharetta, GA
Tel: 770-640-0034
Fax: 770-640-0307

Boston

Westborough, MA
Tel: 774-760-0087
Fax: 774-760-0088

Chicago

Itasca, IL
Tel: 630-285-0071
Fax: 630-285-0075

Dallas

Addison, TX
Tel: 972-818-7423
Fax: 972-818-2924

Detroit

Farmington Hills, MI
Tel: 248-538-2250
Fax: 248-538-2260

Kokomo

Kokomo, IN
Tel: 765-864-8360
Fax: 765-864-8387

Los Angeles

Mission Viejo, CA
Tel: 949-462-9523
Fax: 949-462-9608

Santa Clara

Santa Clara, CA
Tel: 408-961-6444
Fax: 408-961-6445

Toronto

Mississauga, Ontario,
Canada
Tel: 905-673-0699
Fax: 905-673-6509

ASIA/PACIFIC

Asia Pacific Office

Suites 3707-14, 37th Floor
Tower 6, The Gateway
Harbour City, Kowloon
Hong Kong
Tel: 852-2401-1200
Fax: 852-2401-3431

Australia - Sydney

Tel: 61-2-9868-6733
Fax: 61-2-9868-6755

China - Beijing

Tel: 86-10-8528-2100
Fax: 86-10-8528-2104

China - Chengdu

Tel: 86-28-8665-5511
Fax: 86-28-8665-7889

China - Fuzhou

Tel: 86-591-8750-3506
Fax: 86-591-8750-3521

China - Hong Kong SAR

Tel: 852-2401-1200
Fax: 852-2401-3431

China - Qingdao

Tel: 86-532-8502-7355
Fax: 86-532-8502-7205

China - Shanghai

Tel: 86-21-5407-5533
Fax: 86-21-5407-5066

China - Shenyang

Tel: 86-24-2334-2829
Fax: 86-24-2334-2393

China - Shenzhen

Tel: 86-755-8203-2660
Fax: 86-755-8203-1760

China - Shunde

Tel: 86-757-2839-5507
Fax: 86-757-2839-5571

China - Wuhan

Tel: 86-27-5980-5300
Fax: 86-27-5980-5118

China - Xian

Tel: 86-29-8833-7250
Fax: 86-29-8833-7256

ASIA/PACIFIC

India - Bangalore

Tel: 91-80-4182-8400
Fax: 91-80-4182-8422

India - New Delhi

Tel: 91-11-4160-8631
Fax: 91-11-4160-8632

India - Pune

Tel: 91-20-2566-1512
Fax: 91-20-2566-1513

Japan - Yokohama

Tel: 81-45-471-6166
Fax: 81-45-471-6122

Korea - Gumi

Tel: 82-54-473-4301
Fax: 82-54-473-4302

Korea - Seoul

Tel: 82-2-554-7200
Fax: 82-2-558-5932 or
82-2-558-5934

Malaysia - Penang

Tel: 60-4-646-8870
Fax: 60-4-646-5086

Philippines - Manila

Tel: 63-2-634-9065
Fax: 63-2-634-9069

Singapore

Tel: 65-6334-8870
Fax: 65-6334-8850

Taiwan - Hsin Chu

Tel: 886-3-572-9526
Fax: 886-3-572-6459

Taiwan - Kaohsiung

Tel: 886-7-536-4818
Fax: 886-7-536-4803

Taiwan - Taipei

Tel: 886-2-2500-6610
Fax: 886-2-2508-0102

Thailand - Bangkok

Tel: 66-2-694-1351
Fax: 66-2-694-1350

EUROPE

Austria - Wels

Tel: 43-7242-2244-3910
Fax: 43-7242-2244-393

Denmark - Copenhagen

Tel: 45-4450-2828
Fax: 45-4485-2829

France - Paris

Tel: 33-1-69-53-63-20
Fax: 33-1-69-30-90-79

Germany - Munich

Tel: 49-89-627-144-0
Fax: 49-89-627-144-44

Italy - Milan

Tel: 39-0331-742611
Fax: 39-0331-466781

Netherlands - Drunen

Tel: 31-416-690399
Fax: 31-416-690340

Spain - Madrid

Tel: 34-91-708-08-90
Fax: 34-91-708-08-91

UK - Wokingham

Tel: 44-118-921-5869
Fax: 44-118-921-5820

08/29/06

Компания «Океан Электроники» предлагает заключение долгосрочных отношений при поставках импортных электронных компонентов на взаимовыгодных условиях!

Наши преимущества:

- Поставка оригинальных импортных электронных компонентов напрямую с производств Америки, Европы и Азии, а так же с крупнейших складов мира;
- Широкая линейка поставок активных и пассивных импортных электронных компонентов (более 30 млн. наименований);
- Поставка сложных, дефицитных, либо снятых с производства позиций;
- Оперативные сроки поставки под заказ (от 5 рабочих дней);
- Экспресс доставка в любую точку России;
- Помощь Конструкторского Отдела и консультации квалифицированных инженеров;
- Техническая поддержка проекта, помощь в подборе аналогов, поставка прототипов;
- Поставка электронных компонентов под контролем ВП;
- Система менеджмента качества сертифицирована по Международному стандарту ISO 9001;
- При необходимости вся продукция военного и аэрокосмического назначения проходит испытания и сертификацию в лаборатории (по согласованию с заказчиком);
- Поставка специализированных компонентов военного и аэрокосмического уровня качества (Xilinx, Altera, Analog Devices, Intersil, Interpoint, Microsemi, Actel, Aeroflex, Peregrine, VPT, Syfer, Eurofarad, Texas Instruments, MS Kennedy, Miteq, Cobham, E2V, MA-COM, Hittite, Mini-Circuits, General Dynamics и др.);

Компания «Океан Электроники» является официальным дистрибьютором и эксклюзивным представителем в России одного из крупнейших производителей разъемов военного и аэрокосмического назначения «**JONHON**», а так же официальным дистрибьютором и эксклюзивным представителем в России производителя высокотехнологичных и надежных решений для передачи СВЧ сигналов «**FORSTAR**».



JONHON

«**JONHON**» (основан в 1970 г.)

Разъемы специального, военного и аэрокосмического назначения:

(Применяются в военной, авиационной, аэрокосмической, морской, железнодорожной, горно- и нефтедобывающей отраслях промышленности)

«**FORSTAR**» (основан в 1998 г.)

ВЧ соединители, коаксиальные кабели,
кабельные сборки и микроволновые компоненты:

(Применяются в телекоммуникациях гражданского и специального назначения, в средствах связи, РЛС, а так же военной, авиационной и аэрокосмической отраслях промышленности).



Телефон: 8 (812) 309-75-97 (многоканальный)

Факс: 8 (812) 320-03-32

Электронная почта: ocean@oceanchips.ru

Web: <http://oceanchips.ru/>

Адрес: 198099, г. Санкт-Петербург, ул. Калинина, д. 2, корп. 4, лит. А