

LT1374 Monolithic 4A Switcher

5.5V to 25V Input

3.3V or 5V Output

DESCRIPTION

Demonstration circuits DC187/DC188 are complete DC/DC step-down regulators using the LT[®]1374, constant frequency, high efficiency converter in 7-pin DD (DC187) and SO-8 (DC188) packages. These circuits are primarily used in personal computers, disk drives, portable hand-

held devices and in larger systems, as local onboard regulators. High frequency switching allows the use of small inductors, making these all surface mount solutions ideal for space-conscious systems.

LT, LTC and LT are registered trademarks of Linear Technology Corporation.

PERFORMANCE SUMMARY

$T_A = 25^\circ\text{C}$, $V_{IN} = 10\text{V}$, $I_{LOAD} = 2\text{A}$, $V_{OUT} = 3.3\text{V}$ (Jumper J1 inserted), $\overline{\text{SHDN}}$ pin open unless otherwise noted.

PARAMETER	CONDITIONS	MIN	TYP	MAX	UNITS
Output Voltage	Jumper J1 Removed (Note 1)	4.91	5.02	5.20	V
	Jumper J1 Inserted	3.23	3.30	3.42	V
Maximum I_{LOAD}	(Note 2)	4			A
Input Voltage Range	(Note 3)	5.5		25	V
Switching Frequency		460	500	540	kHz
Output Ripple Voltage			60		mV _{p-p}
Line Regulation	5.5V to 25V		8		mV
Load Regulation	$I_{LOAD} = 10\text{mA}$ to 4A		5		mV
$\overline{\text{SHDN}}$ Lockout Threshold	Shutdown Option Boards	2.3	2.38	2.46	V
$\overline{\text{SHDN}}$ Shutdown Threshold	Shutdown Option Boards	0.15	0.37	0.6	V
Synchronization Range	SYNC Option Boards	580		1000	kHz
Supply Current	$\overline{\text{SHDN}} = 0\text{V}$		20		μA

Note 1: Output voltage variations include the $\pm 1\%$ tolerance of the feedback-divider network. For tighter voltage range, use higher tolerance resistors or a fixed 5V output device, the LT1374-5.

Note 2: For DC188 additional thermal restrictions apply.

Note 3: For operating voltages down to 4V consult LTC Marketing for details on the LT1506.

BOARD PHOTOS

DC187



DC188



TYPICAL PERFORMANCE CHARACTERISTICS

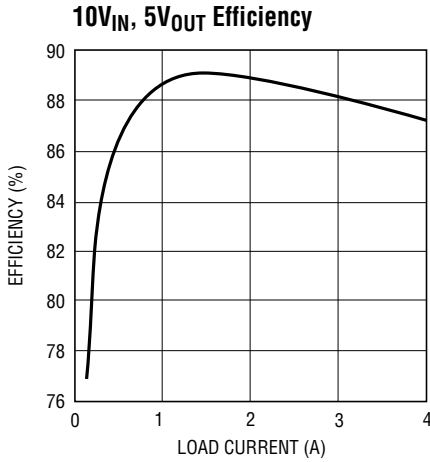

187/88 TA01

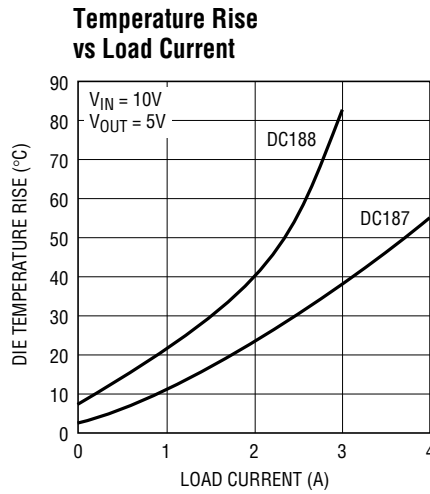

187/88 TA02

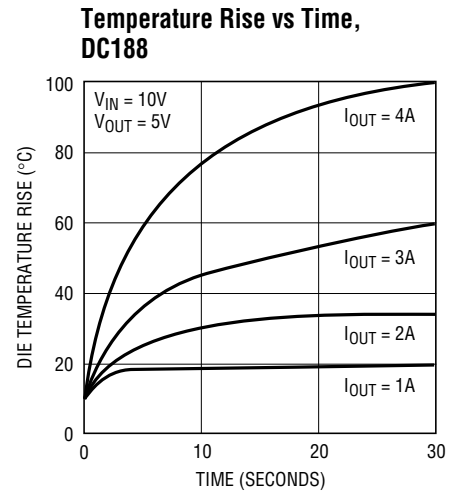

187/88 TA03

PACKAGE A D SCHEMATIC DIAGRAMS

DC187

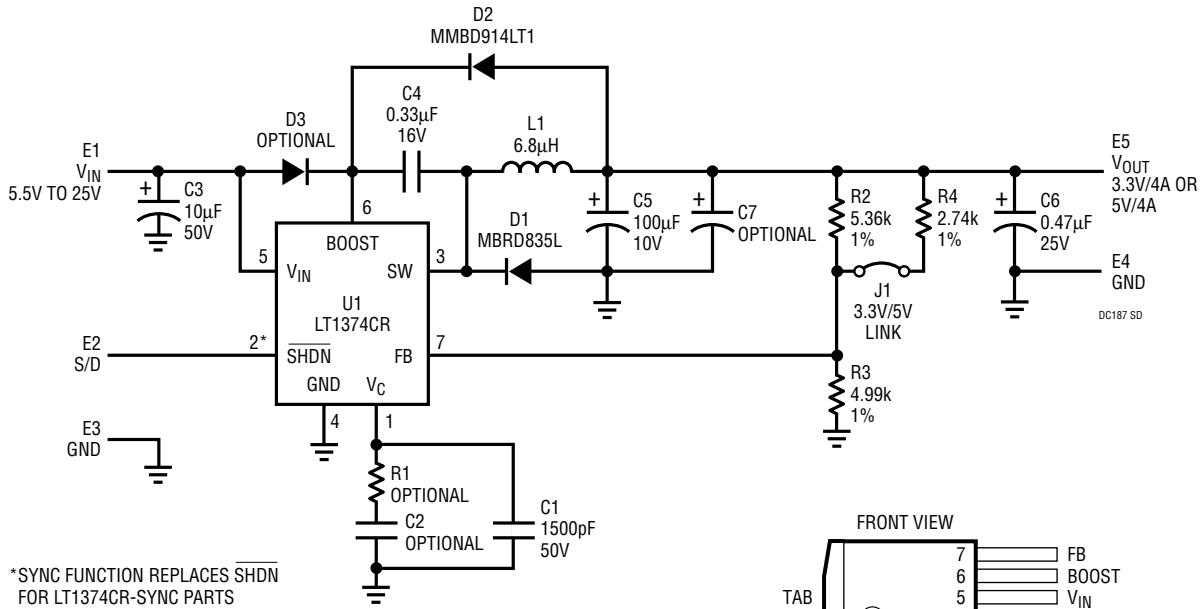

*SYNC FUNCTION REPLACES SHDN FOR LT1374CR-SYNC PARTS

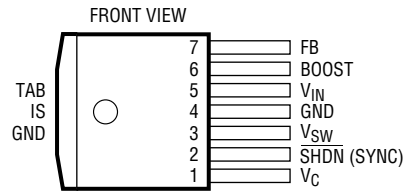

R PACKAGE
7-LEAD PLASTIC DD PAK

LT1374CR (LT1374CR-SYNC)

PACKAGE A MD SCHEMATIC DIAGRAMS

DC188

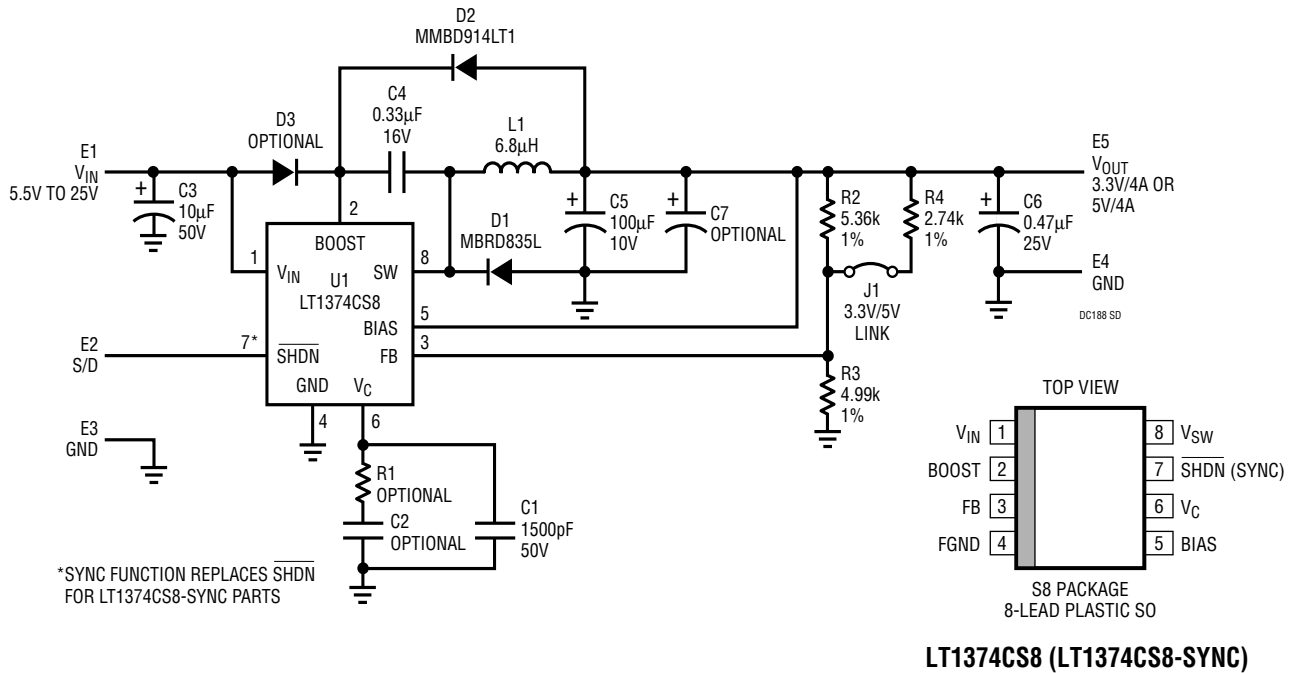

PARTS LIST

REFERENCE DESIGNATOR	QUANTITY	PART NUMBER	DESCRIPTION	VENDOR	TELEPHONE
C1	1	08055C152MAT2S	1500pF 50V X7R Chip Capacitor	AVX	(803) 946-0362
C2, C7	2		Optional Capacitor		
C3	1	THCR60E1H106ZT	10µF 50V Y5U Chip Capacitor	Marcon	(847) 696-2000
C4	1	0805YC334MAT2S	0.33µF 16V X7R Chip Capacitor	AVX	(803) 946-0362
C5	1	TPSD107M010R0100	100µF 10V TPS Tantalum Capacitor	AVX	(207) 282-5111
C6	1	12063G474MAT3S	0.47µF 25V Y5V Chip Capacitor	AVX	(803) 946-0362
D1	1	MBRD835L	SMT Diode	Motorola	(602) 244-3576
D2	1	MMBD914LT1	Diode	Motorola	(602) 244-3576
D3	1		Optional Diode		
E1 to E5	5	2501-2	Turret	Mill-Max	(516) 922-6000
J1	1	2802S-02-G2	0.079" Center 2-Pin Header	Comm Con	(818) 301-4200
P1	1	CCIJ2MM-138-G	0.079" Center 2-Pin Shunt	Comm Con	(818) 301-4200
L1	1	DO3316P-682	6.8µH 20% Inductor	Coilcraft	(847) 639-1469
R1	1		Optional Resistor		
R2	1	CR10-5361F-T	5.36k 1/8W 1% Chip Resistor	TAD	(714) 255-9123
R3	1	CR10-4991F-T	4.99k 1/8W 1% Chip Resistor	TAD	(714) 255-9123
R4	1	CR10-2741F-T	2.74k 1/8W 1% Chip Resistor	TAD	(714) 255-9123
U1 (DC187)	1	LT1374CR (-SYNC)	IC	LTC	(408) 432-1900
U1 (DC188)	1	LT1374CS8 (-SYNC)	IC	LTC	(408) 432-1900

OPERATION

DC187 vs DC188 (Temperature vs Package Size)

The DC187 and DC188 demonstration boards are intended for evaluation of the LT1374 switching regulator in the 7-pin DD and SO-8 packages, respectively. The boards are electrically identical; they differ only in package layout (the BIAS pin is not available in the DD package). The primary reason for choosing the SO-8 over the DD package is board space. The DC187 (DD package) occupies an active board area of approximately 0.75 square inches. Optimizing the DC188 board, by using a Sumida coil and removing the layout options and voltage-selector jumper, a total active area of 0.4 square inches is possible. The DD package is more suitable for higher power or higher ambient-temperature applications. Although both boards will supply 4A of output current, the DC188 must be thermally derated to 3A continuous at 40°C ambient to prevent excessive die temperatures. The DC187 can run at 70°C ambient at 4A output current. The SO-8 package can, however, be used for dynamic loads up to the full rated switch current. The Temperature Rise vs Time, DC188 graph shows the dynamic thermal response of the DC188 board for loads up to 4A.

LT1374 Operation

The LT1374 data sheet gives a complete description of the part, operation and applications information. The data sheet must be read in conjunction with this demo manual.

Hook-Up

Solid turret terminals are provided for easy connection to supplies and test equipment. The jumper should be inserted if a 3.3V output is required. It should be removed for 5V operation. Connect a 0V to 25V, 4.5A power supply across the V_{IN} and GND terminals and the load across the V_{OUT} and GND terminals. When measuring load/line regulation, remember to Kelvin connect to the turrets. Also, when measuring output ripple voltage with an oscilloscope probe, the wire from the probe to the ground clip will act as an antenna, picking up noise. For improved results, the ground clip should be removed from the probe. The tip should be touched against the output turret, with the bare ground shield pressed against the ground turret. This reduces the noise seen on the waveform.

Shutdown Option

(Device Markings LT1374CR or 1374)

For normal operation, the S/D pin can be left floating. S/D has two output-disable modes, lockout and shutdown. When the pin is taken below the lockout threshold, switching is disabled. This is typically used for input undervoltage lockout. Grounding the S/D pin places the LT1374 in shutdown mode. This reduces total board supply current to 20 μ A.

Synchronization Option

(Device Markings LT1374CR-SYNC or 1374SN)

For normal operation the S/D pin can be left floating. To synchronize switching to an external clock, apply a logic-level signal to the S/D pin. Amplitude must be from a logical low to greater than 2.2V with a duty cycle from 10% to 90%. Synchronization frequency must be greater than that of the free-running oscillator and less than 1MHz. Additional circuitry may be required to prevent subharmonic oscillation—refer to the data sheet for more details.

COMPONENTS

Inductor L1

The inductor is a Coilcraft DO3316P-682, a 6.8 μ H unshielded ferrite unit. It is selected for its low cost, small size and 4.6A I_{SAT} rating. The equivalent Coiltronics UP2-6R8 unit can be substituted. If board space is at a premium and higher ripple current is acceptable, DC188 has the solder pads available for the Sumida CD43-1R8 inductor. This 1.8 μ H unit has a 2.9A I_{SAT} rating. With this coil, ripple at 10V $_{IN}$, 5V $_{OUT}$ is ± 1.5 A. This gives a maximum output current of $(4.5A - 1.5A) = 3A$. At input voltages above 15V, C7 should be inserted in parallel with C5 to increase output capacitor ripple rating.

Input/Output Capacitors C3, C5, C6 and C7

The input capacitor, C3, is a Tokin ceramic capacitor. It was selected for its small size, high voltage rating and low ESR (effective series resistance). The input ripple current for a buck converter is high, typically $I_{OUT}/2$. Tantalum capacitors become resistive at higher frequencies, requiring careful ripple-rating selection to prevent excessive

OPERATION

heating. Ceramic capacitors' ESL (effective series inductance) tends to dominate their ESR, making them less susceptible to ripple-induced heating. The output capacitor, C5, is an AVX tantalum capacitor. A ceramic is not recommended as the main output capacitor since loop stability relies on a resistive characteristic at higher frequencies to form a zero. The AVX TPS series, specifically designed for use in switch mode power supplies, has very low ESR. At switching frequencies, ripple voltage is more a function of ESR than of absolute capacitance value. If lower output ripple voltage is required, use the optional capacitor, C7, to reduce ESR, rather than increasing the capacitance of C5. For very low ripple, an additional LC filter on the output may be a cheaper solution. The output contains very narrow voltage spikes because of the parasitic inductance of C5. A small ceramic capacitor, C6, removes these spikes on the demo board. In application circuits, trace inductance and local bypass capacitors may perform this function, negating the need for C6.

Catch Diode D1

Use diodes designed for switching applications, such as Schottky or ultrafast diodes, with adequate current rating and fast turn-on times. In selecting a diode, the basic parameters of interest are forward voltage, maximum reverse voltage, average operating current and peak current. Lower forward voltage yields higher circuit efficiency and lowers power dissipation in the diode. The MBRD835L has a maximum forward drop of 0.4V at 3A. The reverse voltage rating must be greater than the input voltage. Average diode current is always less than output current, but under a shorted output condition, diode current can equal the switch current limit. If the application must withstand this condition, the diode must be rated for maximum switch current.

Compensation: C1, C2 and R1

A detailed discussion of frequency compensation can be found in the LT1374 data sheet. C1, a 1500pF capacitor from V_C to ground, gives a stable loop response over a wide range of input and output conditions. Options R1 and C2 are included to optimize the dynamic response for specific applications.

Boost: D2, D3 and C4

A boost voltage of at least 2.8V is required throughout the on time of the switch to guarantee that it remains saturated. For output voltages of 3.3V or more, diode D2 provides sufficient boost voltage to C4. Below 3.3V, D2 can be moved to position D3, powering boost from V_{IN} .

PCB LAYOUT

In many cases, the layout of the demonstration board may be dropped directly into the application with minimal changes. If this is not practical, there are several precautions that must be taken when laying out high frequency converter circuits. The high frequency switching path runs from ground, through C3 to the V_{IN} pin of the LT1374, out of the SW pin, through D1 and back to ground. This loop acts as an antenna and will radiate noise if not kept as short as possible. Also, at higher switching currents the associated trace inductance can cause excessive voltage spikes across the switch. The use of a ground plane will reduce many noise problems. The ground pin of the LT1374 contains some high frequency signal currents, but more importantly, it is the 0V reference for the output voltage. Connect the ground pin directly to the ground plane. The FB and V_C components should be kept away from the power components as much as possible. The ground for these components should be separated from power grounds. Run a Kelvin sense to V_{OUT} as required, but keep the divider network close to the LT1374 to prevent noise pick-up on the FB node. Noise pickup on the V_C pin appears as various problems, including poor load regulation, subharmonic oscillation and instability. Thermal management must also be considered. The SO-8 package has a fused ground pin. Soldering this pin to a large copper area will significantly reduce its thermal resistance. Solder filled feedthroughs close to the ground pin provide a good thermal path to the ground plane. For the DD package, the grounded tab should be treated in the same way. For more information or advice, contact the LTC Applications department.

PCB LAYOUT AND FILM

DC187

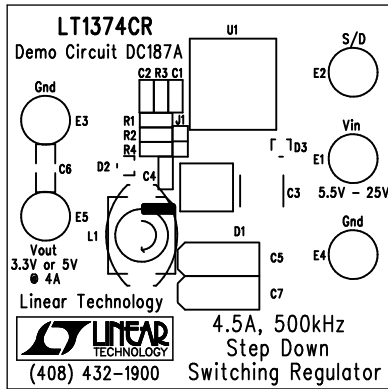

Component Side Silkscreen

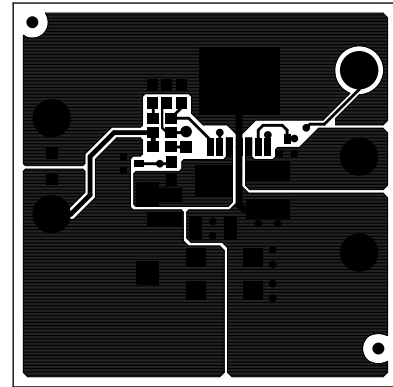

Component Side

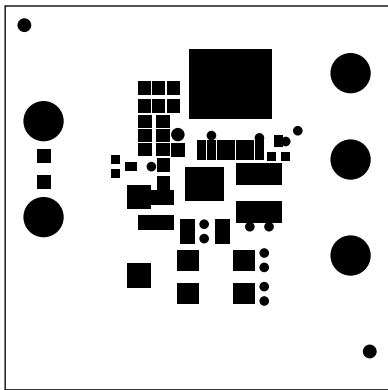

Component Side Solder Mask

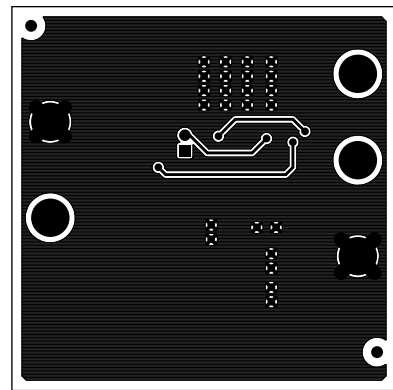

Solder Side

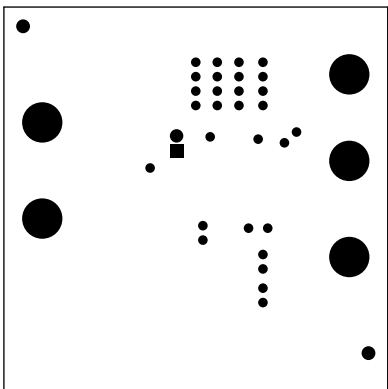

Solder Side Solder Mask

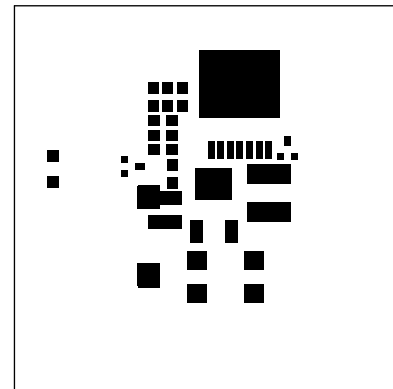

Pastemask

PCB LAYOUT AND FILM

DC188

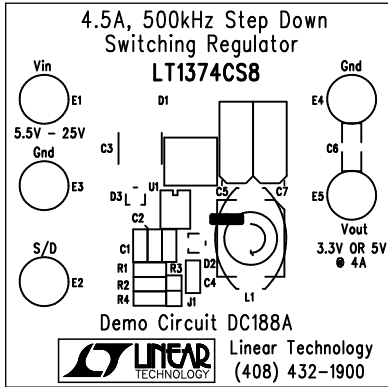

Component Side Silkscreen

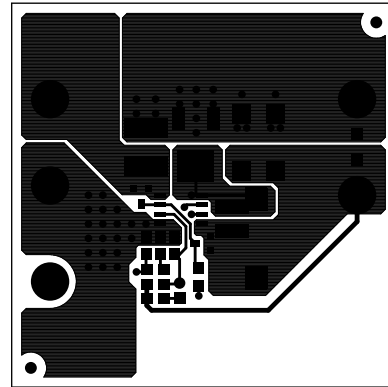

Component Side

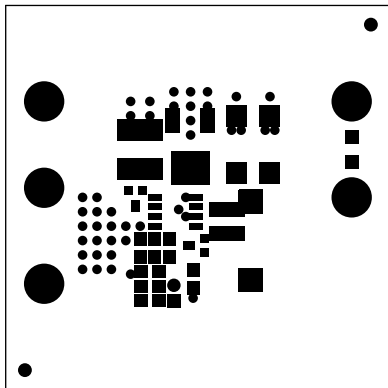

Component Side Solder Mask

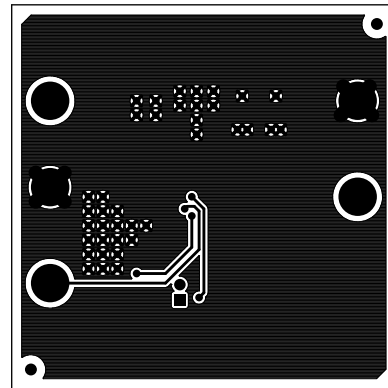

Solder Side

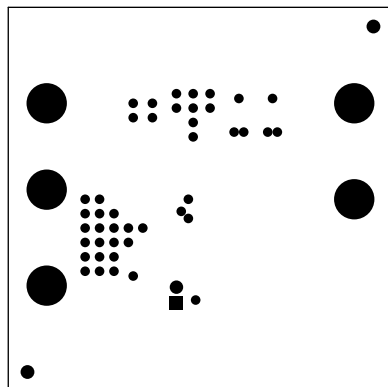

Solder Side Solder Mask

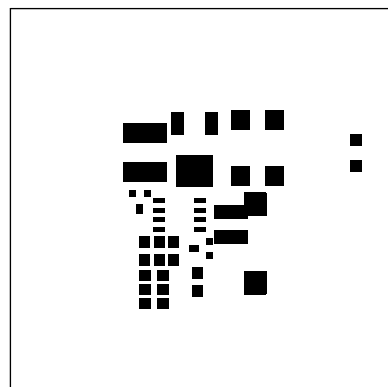

Pastemask

DEMO MANUAL DC187/DC188

PC FAB DRAWINGS

DC187

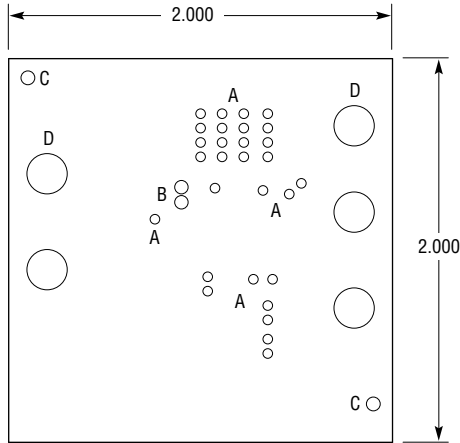

- NOTES: UNLESS OTHERWISE SPECIFIED
1. MATERIAL: FR4 OR EQUIVALENT EPOXY,
2 OZ COPPER CLAD, THICKNESS 0.062 ±0.006
TOTAL OF 2 LAYERS
 2. FINISH: ALL PLATED HOLES 0.001 MIN/0.0015 MAX
COPPER PLATE, ELECTRODEPOSITED TIN-LEAD COMPOSITION
BEFORE REFLOW, SOLDER MASK OVER BARE COPPER (SMOBC)
 3. SOLDER MASK: BOTH SIDES USING GREEN SR1020 OR EQUIVALENT
 4. SILKSCREEN: USING WHITE NONCONDUCTIVE EPOXY INK
 5. ALL DIMENSIONS IN INCHES

SYMBOL	DIAMETER	NUMBER OF HOLES
A	0.020	29
B	0.037	2
C	0.072	2
D	0.095	5
TOTAL HOLES		38

187 FD

DC188

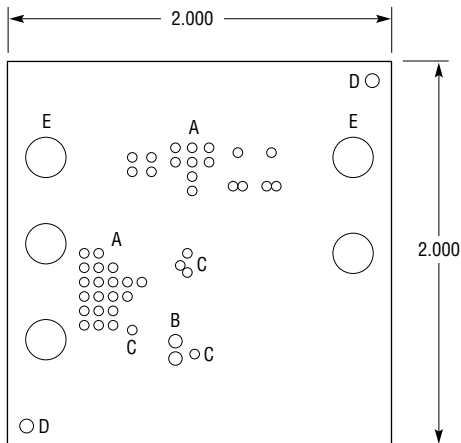

- NOTES: UNLESS OTHERWISE SPECIFIED
1. MATERIAL: FR4 OR EQUIVALENT EPOXY,
2 OZ COPPER CLAD, THICKNESS 0.062 ±0.006
TOTAL OF 2 LAYERS
 2. FINISH: ALL PLATED HOLES 0.001 MIN/0.0015 MAX
COPPER PLATE, ELECTRODEPOSITED TIN-LEAD COMPOSITION
BEFORE REFLOW, SOLDER MASK OVER BARE COPPER (SMOBC)
 3. SOLDER MASK: BOTH SIDES USING GREEN SR1020 OR EQUIVALENT
 4. SILKSCREEN: USING WHITE NONCONDUCTIVE EPOXY INK
 5. ALL DIMENSIONS IN INCHES

SYMBOL	DIAMETER	NUMBER OF HOLES
A	0.020	38
B	0.037	2
C	0.025	5
D	0.072	2
E	0.095	5
TOTAL HOLES		38

188 FD

Компания «Океан Электроники» предлагает заключение долгосрочных отношений при поставках импортных электронных компонентов на взаимовыгодных условиях!

Наши преимущества:

- Поставка оригинальных импортных электронных компонентов напрямую с производств Америки, Европы и Азии, а так же с крупнейших складов мира;
- Широкая линейка поставок активных и пассивных импортных электронных компонентов (более 30 млн. наименований);
- Поставка сложных, дефицитных, либо снятых с производства позиций;
- Оперативные сроки поставки под заказ (от 5 рабочих дней);
- Экспресс доставка в любую точку России;
- Помощь Конструкторского Отдела и консультации квалифицированных инженеров;
- Техническая поддержка проекта, помощь в подборе аналогов, поставка прототипов;
- Поставка электронных компонентов под контролем ВП;
- Система менеджмента качества сертифицирована по Международному стандарту ISO 9001;
- При необходимости вся продукция военного и аэрокосмического назначения проходит испытания и сертификацию в лаборатории (по согласованию с заказчиком);
- Поставка специализированных компонентов военного и аэрокосмического уровня качества (Xilinx, Altera, Analog Devices, Intersil, Interpoint, Microsemi, Actel, Aeroflex, Peregrine, VPT, Syfer, Eurofarad, Texas Instruments, MS Kennedy, Miteq, Cobham, E2V, MA-COM, Hittite, Mini-Circuits, General Dynamics и др.);

Компания «Океан Электроники» является официальным дистрибьютором и эксклюзивным представителем в России одного из крупнейших производителей разъемов военного и аэрокосмического назначения «JONHON», а так же официальным дистрибьютором и эксклюзивным представителем в России производителя высокотехнологичных и надежных решений для передачи СВЧ сигналов «FORSTAR».



JONHON

«JONHON» (основан в 1970 г.)

Разъемы специального, военного и аэрокосмического назначения:

(Применяются в военной, авиационной, аэрокосмической, морской, железнодорожной, горно- и нефтедобывающей отраслях промышленности)

«FORSTAR» (основан в 1998 г.)

ВЧ соединители, коаксиальные кабели, кабельные сборки и микроволновые компоненты:

(Применяются в телекоммуникациях гражданского и специального назначения, в средствах связи, РЛС, а так же военной, авиационной и аэрокосмической отраслях промышленности).



Телефон: 8 (812) 309-75-97 (многоканальный)

Факс: 8 (812) 320-03-32

Электронная почта: ocean@oceanchips.ru

Web: <http://oceanchips.ru/>

Адрес: 198099, г. Санкт-Петербург, ул. Калинина, д. 2, корп. 4, лит. А