

Power Relay RM 2/3/7

- 2 / 3 pole 10 / 16 A, 2 CO or 3 CO contacts
- Switching capacity up to 6000 VA
- DC- or AC-coil
- Mechanical indicator
- Push-to-test-button
- Plug-in version, PCB terminals, chassis- or DIN-rail mount
- RoHS compliant (Directive 2002/95/EC) as per product date code 0415



F0163-A

Applications

Elevator control, power supplies

Approvals

VDE REG.-Nr. 40003144, **UL** E214025
Technical data of approved types on request

Contact data	RM2	RM3	RM7
Contact configuration	2 CO	3 CO	3 CO
Contact set	single contact		
Type of interruption	micro disconnection		
Rated current	16 A	10 A	16 A
Rated voltage / max.switching voltage AC	400/440 VAC		
Maximum breaking capacity AC	6000 VA	3800 VA	6000 VA
Limiting making capacity, max 20 ms	40 A	40 A	40 A
Contact material	AgCdO		
Mechanical endurance	20x10 ⁶ cycles		
Rated frequency of operation with / without load	16/100 min ⁻¹		

Contact ratings

Type	Load	Cycles
RM2	16 A, 415 VAC, UL	100x10 ³
RM20	16 A, 400 VAC, cosφ=1, 35°C, VDE	100x10 ³
RM2	16 A, 250 VAC, general purpose, UL	30x10 ³
RM20	10 A, 48 VDC, UL	30x10 ³
RM30	10 A, 400 VAC, cosφ=1, 35°C, VDE	100x10 ³
RM3	10 A, 300 VAC, resistive, UL	100x10 ³
RM3	10 A, 250 VAC, general purpose, UL	30x10 ³
RM7	5 A, 400 VAC, resistive, UL	100x10 ³
RM70	16 A, 400 VAC, cosφ=1, 35°C, VDE	100x10 ³
RM7	10 A, 300 VAC, resistive, UL	100x10 ³
RM7	10 A, 415 VAC, 10% duty cycle, NO, 70°C, DC-coil	100x10 ³

Coil data	RM2	RM3	RM7
Rated coil voltage range DC coil	6...220 VDC		
AC coil	6...400 VAC		
Coil power DC coil	1.2 W	1.2 W	1.6 W
AC coil	2.3 VA	2.3 VA	2.8 VA
Operative range	1		

Coil versions, DC-coil

Coil code	Rated voltage VDC	Operate voltage VDC	Release voltage VDC	Coil resistance Ohm	Rated coil power W
STD LED PD* bipolar	LED+ PD*				

Coil versions, DC-coil, RM2, RM3

006	L06	0A6	LA6	6	4.5	0.6	32±10%	1.1
012	L12	0B2	LB2	12	9.0	1.2	110±10%	1.3
024	L24	0C4	LC4	24	18.0	2.4	475±10%	1.2
048	L48	0E8	LE8	48	36.0	4.8	2000±10%	1.2
060	L60	0G0	LG0	60	45.0	6.0	2850±10%	1.3
110	M10	1B0	MB0	110	82.5	11.0	10000±12%	1.2

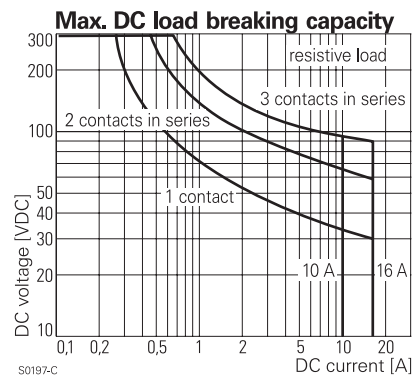

S0197-C

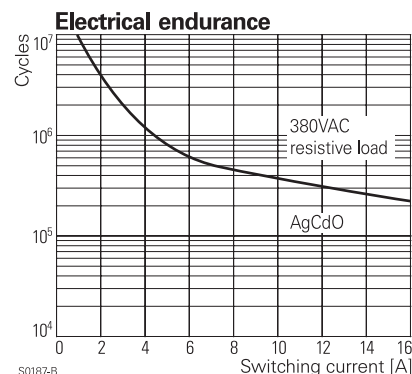

S0197-B

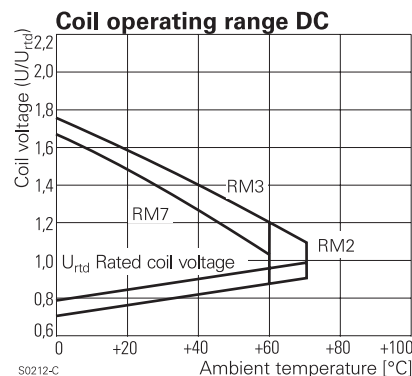

S0212-C

221	N21	2C1	NC1	220	165.0	22.0	40000±15%	1.2	
Coil versions, DC-coil, RM7									
Coil code	STD	LED	PD*	LED+	Rated voltage	Operate voltage	Release voltage	Coil resistance	Rated coil power
	bipolar				VDC	VDC	VDC	Ohm	W
006	L06	0A6	LA6		6	4.5	0.6	24±10%	1.5
012	L12	0B2	LB2		12	9.0	1.2	86±10%	1.7
024	L24	0C4	LC4		24	18.0	2.4	345±10%	1.7
048	L48	0E8	LE8		48	36.0	4.8	1340±10%	1.7
060	L60	0G0	LG0		60	45.0	6.0	2200±10%	1.6
110	M10	1B0	MB0		110	82.5	11.0	7300±10%	1.7
221	N21	2C1	NC1		220	165.0	22.0	30000±15%	1.6

All figures are given for coil without preenergization, at ambient temperature +23°C

*) Protection diode PD; standard polarity: +A1 / -A2

Coil versions, AC-coil 50/60 Hz

Coil code	STD	LED	Rated voltage	Operate voltage	Release voltage	Coil resistance	Rated coil power
			VAC	50/60Hz	50/60Hz	Ohm	50/60Hz
			VAC	VAC	VAC	Ohm	VA

Coil versions, AC-coil, RM2, RM3

506	R06	6	4.8	2.4	5.3±10%	2.29/1.98
512	R12	12	9.6	4.8	24±10%	2.19/1.86
524	R24	24	19.2	9.6	86±10%	2.26/1.95
548	R48	48	38.4	19.2	345±10%	2.28/1.97
560	R60	60	48.0	24.0	544±10%	2.27/1.96
615	S15	115	92.0	46.0	2000±10%	2.37/2.00
730	T30	230	184.0	92.0	8300±12%	2.32/1.96
900	V00	400	320.0	160.0	27500±15%	2.31/1.96

Coil versions, AC-coil, RM7

506	R06	6	4.8	2.4	4.7±10%	2.86/2.36
512	R12	12	9.6	4.8	19.5±10%	2.71/2.27
524	R24	24	19.2	9.6	80±10%	2.62/2.00
548	R48	48	38.4	19.2	320±10%	2.60/2.17
560	R60	60	48.0	24.0	500±10%	2.62/2.20
615	S15	115	92.0	46.0	1850±10%	2.65/2.22
730	T30	230	184.0	92.0	7500±10%	2.69/2.26
900	V00	400	320.0	160.0	23500±15%	2.61/2.20

All figures are given for coil without preenergization, at ambient temperature +23°C

Insulation

Dielectric strength coil-contact circuit	2500 V _{rms}
open contact circuit	1500 V _{rms}
adjacent contact circuits	2500 V _{rms}
Clearance / creepage coil-contact circuit	≥ 4.0/14.9 mm
adjacent contact circuits	≥ 6.1/7.3 mm
Material group of insulation parts	≥ IIIa
Insulation to IEC 60664-1	
Type of insulation coil-contact circuit	basic
open contact circuit	functional
adjacent contact circuits	basic
Rated insulation voltage	250 V
Pollution degree	3
Rated voltage system	240/400 V
Overvoltage category	III

Other data

RoHS - Directive 2002/95/EC	compliant as per product date code 0415		
Ambient temperature range DC coil	-45...+70°C	-45...+60°C	-45...+60°C
AC coil	-45...+55°C	-45...+55°C	-45...+50°C
Operate- / release time	15/10 ms		
Bounce time NO / NC contact	3 ms		
Vibration resistance (function) NO / NC contact	5/2 g	5/2 g	12/4 g
Category of protection	RTI - dust protected		
Resistance to soldering heat	270°C / 10 s		
Relay weight	81 g		
Packaging unit	10/25 pcs		

Coil operating range AC

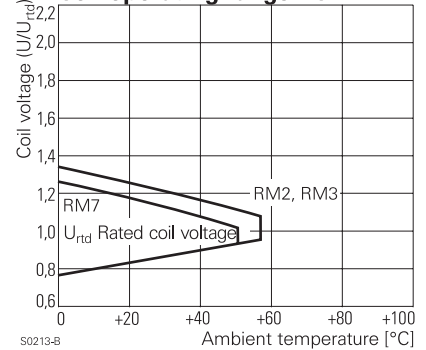

PCB layout / terminal assignment

Bottom view on pins

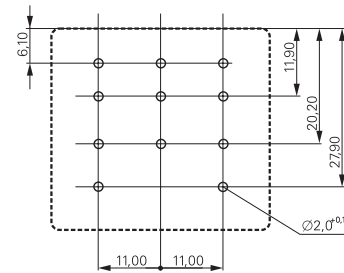

S0269-AA

3 CO contacts

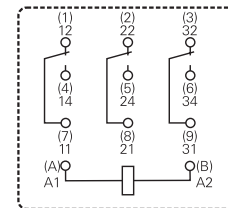

S0269-AB

2 CO contacts

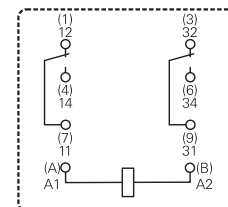

S0269-AD

Power Relay RM 2/3/7 (Continued)

Accessories

For details see datasheet

Accessories Power Relay RM

Dimensions

Plain cover, plug-in version

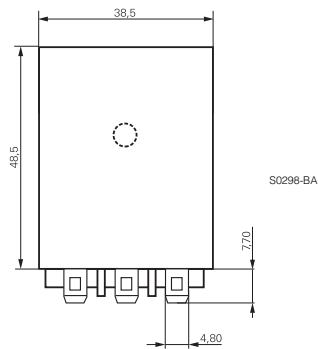

PCB version

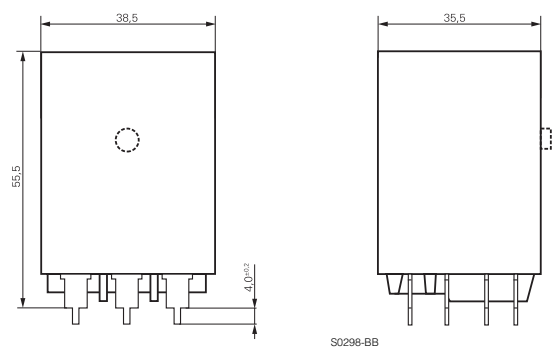

Cover with mounting brackets, 6.3 mm quick connect (4.8 mm available)

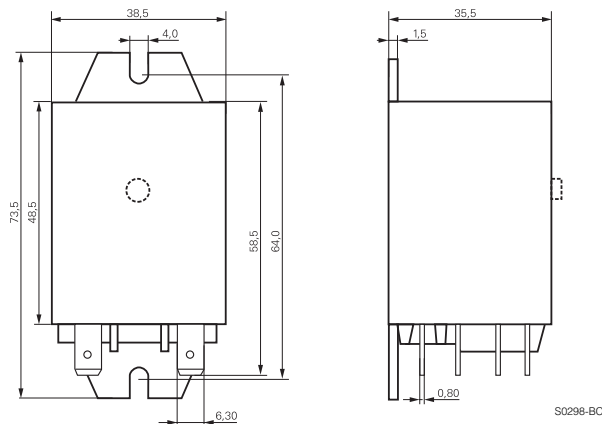

Cover with DIN-snap-on attachment (6.3 mm quick connect only) horizontal

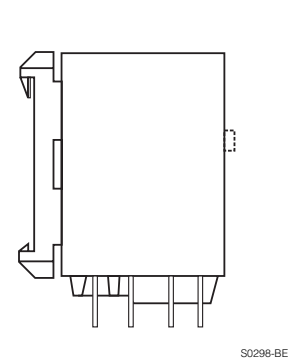
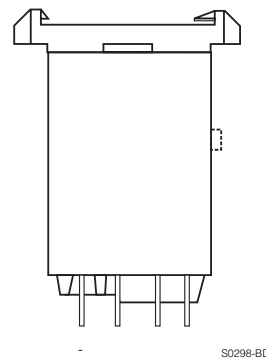

Product key

Type

Contact configuration

- 2** 2 CO contacts, 16 A
- 3** 3 CO contacts, 10 A
- 7** 3 CO contacts, 16 A

Version

- 0** AgCdO, without test button
- 3** AgCdO, with test button

Enclosure

- 2** plain cover, 4.8 mm quick connect terminals
- 3** cover with mounting brackets, 4.8 mm quick connect terminals
- 5** cover with mounting brackets, 6.3 mm quick connect terminals
- 7** PCB version
- 8** cover with DIN-snap-on attachment, horizontal, 6.3 mm quick connect terminals
- 9** cover with DIN-snap-on attachment, vertical, 6.3 mm quick connect terminals

Coil

Coil code: please refer to coil versions table, preferred types in bold print

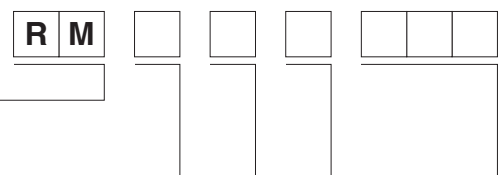

Product key	Contacts	Version	Enclosure	Coil	Coil	Part number
RM202024	2 CO contacts 16 A	without test button	plain cover	DC-coil	24 VDC	8-1393149-2
RM202524			quick c. 4.8 mm	AC-coil	24 VAC	1-1393146-9
RM202615					115 VAC	2-1393146-0
RM202730					230 VAC	1-1393148-4
RM203024			mounting brackets quick c. 4.8 mm	DC-coil	24 VDC	1-1393148-6
RM203524				AC-coil	24 VAC	2-1393146-5
RM203615					115 VAC	2-1393146-6
RM203730					230 VAC	2-1393146-8
RM205024			mounting brackets quick c. 6.3 mm	DC-coil	24 VDC	2-1393146-9
RM205524				AC-coil	24 VAC	3-1393146-0
RM205615					115 VAC	3-1393146-1
RM205730					230 VAC	3-1393146-2
RM207024			PCB version	DC-coil	24 VDC	3-1393146-3
RM207615				AC-coil	115 VAC	8-1393149-5
RM207730					230 VAC	3-1393146-4
RM208024			DIN-snap-on horizontal	DC-coil	24 VDC	3-1393146-5
RM208730				AC-coil	230 VAC	8-1393149-6
RM209730			DIN vertical		230 VAC	3-1393146-6
RM232024	with test button		plain cover	DC-coil	24 VDC	3-1393146-8
RM232524			quick c. 4.8 mm	AC-coil	24 VAC	3-1393146-9
RM232615					115 VAC	4-1393146-0
RM232730					230 VAC	3-1393107-4
RM233024			mounting brackets quick c. 4.8 mm	DC-coil	24 VDC	3-1393107-5
RM233615				AC-coil	115 VAC	4-1393146-2
RM235024			mounting brackets quick c. 6.3 mm	DC-coil	24 VDC	8-1393149-8
RM235730				AC-coil	230 VAC	4-1393146-5
RM239730			DIN vertical		230 VAC	4-1393148-7
RM302024	3 CO contacts 10 A	without test button	plain cover	DC-coil	24 VDC	8-1393149-9
RM302524			quick c. 4.8 mm	AC-coil	24 VAC	5-1393146-3
RM302615					115 VAC	5-1393146-4
RM302730					230 VAC	5-1419150-3
RM303024			mounting brackets quick c. 4.8 mm	DC-coil	24 VDC	6-1393148-4
RM303615				AC-coil	115 VAC	5-1393146-5
RM303730					230 VAC	5-1393146-7
RM307024			PCB version	DC-coil	24 VDC	7-1393148-2
RM307730				AC-coil	230 VAC	5-1393146-9
RM332024	with test button		plain cover	DC-coil	24 VDC	9-1393149-2
RM332524			quick c. 4.8 mm	AC-coil	24 VAC	9-1393149-3
RM332730					230 VAC	9-1393149-4
RM333024			mount. br. q.c.4.8	DC-coil	24 VDC	9-1393149-6
RM335730			mount. br. q.c.6.3	AC-coil	230 VAC	6-1393107-1
RM338730			DIN horizontal		230 VAC	7-1393148-7
RM339730			DIN vertical		230 VAC	6-1393107-2
RM702024	3 CO contacts 16 A	without test button	plain cover	DC-coil	24 VDC	8-1393146-5
RM702524			quick c. 4.8 mm	AC-coil	24 VAC	0-1393844-9
RM702615					115 VAC	1-1393844-0
RM702730					230 VAC	1-1393844-1
RM703024			mounting brackets quick c. 4.8 mm	DC-coil	24 VDC	1-1393844-2
RM703524				AC-coil	24 VAC	9-1393146-1
RM703615					115 VAC	9-1393146-2
RM703730					230 VAC	9-1393146-4
RM705024			mounting brackets quick c. 6.3 mm	DC-coil	24 VDC	9-1393146-6
RM705524				AC-coil	24 VAC	9-1393146-7
RM705615					115 VAC	1-1393844-4
RM705730					230 VAC	1-1393844-5
RM707024			PCB version	DC-coil	24 VDC	9-1393146-8
RM707524				AC-coil	24 VAC	0-1393147-1
RM707730					230 VAC	0-1393147-2
RM708024			DIN horizontal	DC-coil	24 VDC	0-1393147-4
RM708730			quick c. 6.3 mm	AC-coil	230 VAC	1-1419136-0
RM709024			DIN vertical	DC-coil	24 VDC	2-1393149-2
RM709730				AC-coil	230 VAC	0-1393147-5
RM732024	with test button		plain cover	DC-coil	24 VDC	1-1393844-7
RM732524			quick c. 4.8 mm	AC-coil	24 VAC	1-1393147-0
RM732615					115 VAC	1-1393147-1
RM732730					230 VAC	1-1393844-8
RM733730			mount.br. q.c. 4.8		230 VAC	1-1393147-5
RM735024			mounting brackets quick c. 6.3 mm	DC-coil	24 VDC	3-1393149-6
RM735524				AC-coil	24 VAC	3-1393149-7
RM735730					230 VAC	4-1393149-1
RM737730			PCB version		230 VAC	2-1393147-0
RM738024			DIN-snap-on	DC-coil	24 VDC	2-1393844-0
RM738730			horizontal	AC-coil	230 VAC	2-1393147-2
RM739024			DIN-snap-on	DC-coil	24 VDC	4-1393149-5
RM739730			vertical	AC-coil	230 VAC	2-1393844-2

Компания «Океан Электроники» предлагает заключение долгосрочных отношений при поставках импортных электронных компонентов на взаимовыгодных условиях!

Наши преимущества:

- Поставка оригинальных импортных электронных компонентов напрямую с производств Америки, Европы и Азии, а так же с крупнейших складов мира;
- Широкая линейка поставок активных и пассивных импортных электронных компонентов (более 30 млн. наименований);
- Поставка сложных, дефицитных, либо снятых с производства позиций;
- Оперативные сроки поставки под заказ (от 5 рабочих дней);
- Экспресс доставка в любую точку России;
- Помощь Конструкторского Отдела и консультации квалифицированных инженеров;
- Техническая поддержка проекта, помощь в подборе аналогов, поставка прототипов;
- Поставка электронных компонентов под контролем ВП;
- Система менеджмента качества сертифицирована по Международному стандарту ISO 9001;
- При необходимости вся продукция военного и аэрокосмического назначения проходит испытания и сертификацию в лаборатории (по согласованию с заказчиком);
- Поставка специализированных компонентов военного и аэрокосмического уровня качества (Xilinx, Altera, Analog Devices, Intersil, Interpoint, Microsemi, Actel, Aeroflex, Peregrine, VPT, Syfer, Eurofarad, Texas Instruments, MS Kennedy, Miteq, Cobham, E2V, MA-COM, Hittite, Mini-Circuits, General Dynamics и др.);

Компания «Океан Электроники» является официальным дистрибьютором и эксклюзивным представителем в России одного из крупнейших производителей разъемов военного и аэрокосмического назначения «JONHON», а так же официальным дистрибьютором и эксклюзивным представителем в России производителя высокотехнологичных и надежных решений для передачи СВЧ сигналов «FORSTAR».



JONHON

«JONHON» (основан в 1970 г.)

Разъемы специального, военного и аэрокосмического назначения:

(Применяются в военной, авиационной, аэрокосмической, морской, железнодорожной, горно- и нефтедобывающей отраслях промышленности)

«FORSTAR» (основан в 1998 г.)

ВЧ соединители, коаксиальные кабели,
кабельные сборки и микроволновые компоненты:

(Применяются в телекоммуникациях гражданского и специального назначения, в средствах связи, РЛС, а так же военной, авиационной и аэрокосмической отраслях промышленности).



Телефон: 8 (812) 309-75-97 (многоканальный)

Факс: 8 (812) 320-03-32

Электронная почта: ocean@oceanchips.ru

Web: <http://oceanchips.ru/>

Адрес: 198099, г. Санкт-Петербург, ул. Калинина, д. 2, корп. 4, лит. А