

LTC1550/LTC1551
Low Noise, Switched Capacitor,
Regulated Voltage Inverter

DESCRIPTION

Demonstration circuit DC092 is a low noise, regulated voltage inverter using the LTC[®]1550/LTC1551. The all surface mount design demonstrates the small size and compact layout possible with the LTC1550/LTC1551. It is designed for applications such as bias voltage generators for GaAs transmitter FETs in portable RF equipment and cellular telephones. This demo board highlights the low noise capabilities of the LTC1550/LTC1551, which uses an internal linear post regulator to limit output ripple to 1mV_{P-P}.

The LTC1550/LTC1551 provide a TTL compatible Shutdown pin that reduces the supply current typically to 0.2μA. The LTC1550/LTC1551 are identical except for the

polarity of the Shutdown pin. DC092-A uses the LTC1550-4.1CS8, which has an active low Shutdown pin (SHDN), while DC092-B uses the LTC1551-4.1CS8 with an active high Shutdown pin (SHDN). The LTC1550/LTC1551 operate with a supply voltage of 4.5V to 6.5V and produce a fixed -4.1V ±5% output. Normal operating quiescent current is 4mA at no load condition.

Other members of the LTC1550/LTC1551 family contain additional features such as adjustable output voltage, lower minimum V_{CC} voltage requirements and an open-drain output that indicates when the output voltage is in regulation. Please refer to the LTC1550/LTC1551 data sheet for more information.

 LTC and LT are registered trademarks of Linear Technology Corporation.

PERFORMANCE SUMMARY (-30°C < T_A < 85°C)

SYMBOL	PARAMETER	CONDITIONS	BOARD SUFFIX	VALUE
V _{CC}	Supply Voltage		All	4.5V to 6.5V
I _S	Supply Current	I _{OUT} = 0mA I _{OUT} = 5mA I _{OUT} = 10mA Shutdown	All All All All	4mA Typ 9mA Typ 14mA Typ 0.2μA Typ
SHDN	Shutdown	LTC1550-4.1 LTC1551-4.1	A B	TTL Low Level TTL High Level

TYPICAL PERFORMANCE CHARACTERISTICS AND BOARD PHOTO

V_{OUT} Output Noise and Ripple

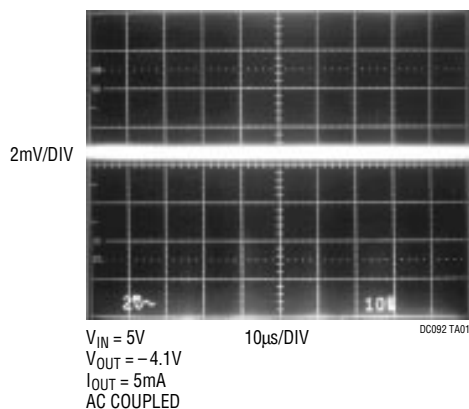

Component Side



DEMO MANUAL DC092

GaAsFET BIAS GENERATOR

PERFORMANCE SUMMARY

SYMBOL	PARAMETER	CONDITIONS	BOARD SUFFIX	VALUE
f_{OSC}	Internal Oscillator Frequency		All	900kHz Typ
V_{RIPPLE}	Ripple Voltage		All	1mV _{P-P} Typ
V_{OUT}	Output Voltage	$V_{CC} = 4.5V, 0 < I_{OUT} < 5mA$	All	-3.9V to -4.3V
		$V_{CC} = 5V, 0 < I_{OUT} < 10mA$	All	-3.9V to -4.3V
		$V_{CC} = 6V, 0 < I_{OUT} < 20mA$	All	-3.9V to -4.3V
		$V_{CC} = 6.5V, 0 < I_{OUT} < 25mA$	All	-3.9V to -4.3V

PACKAGE AND SCHEMATIC DIAGRAMS

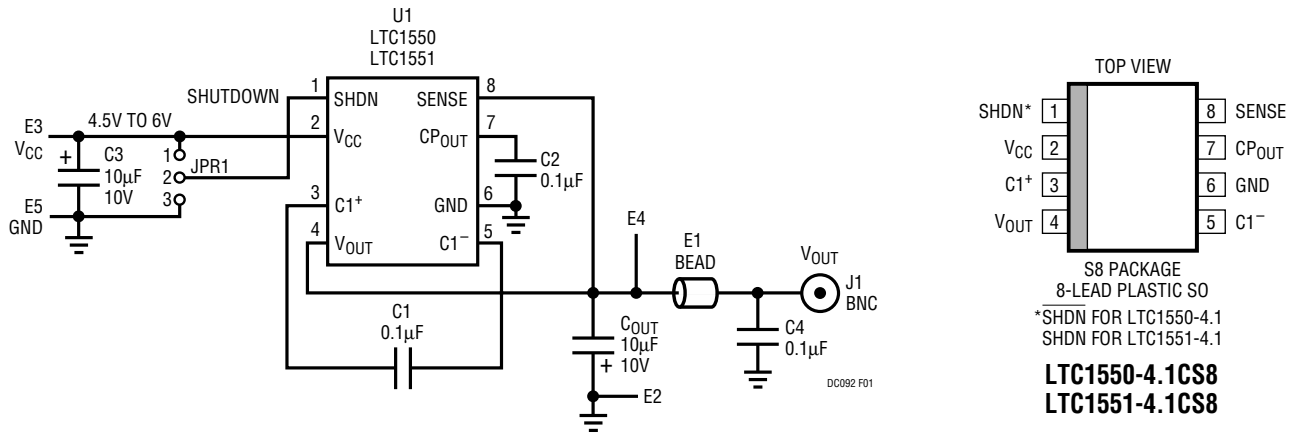

Figure 1. DC092 Schematic (-4.1V Generator)

PARTS LIST

REFERENCE DESIGNATOR	QUANTITY	PART NUMBER	DESCRIPTION	VENDOR	TELEPHONE
C1, C2, C4	3	08055G104ZAT3S	0.1µF 50V 20% Y5V Capacitor	AVX	(803) 946-0362
C3, C _{OUT}	2	595D106X0010A2T	10µF 10V 20% Tantalum Capacitor	Sprague	(207) 324-4140
E1	1	ILB-1206-600	600Ω ±25% Bead	Dale	(605) 665-9301
U1	1	LTC1550-4.1CS8/ LTC1551-4.1CS8	Switched Capacitor Voltage Inverter	LTC	(408) 432-1900

OPERATION

The DC092 demonstration board is intended for the evaluation of the LTC1550/LTC1551. Solid turret terminals are included for easy connections to test equipment and external circuitry. The board schematic and device package pinout are shown in Figure 1. Board DC092-A is assembled with an LTC1550-4.1 which has an active low Shutdown pin; board DC092-B uses the LTC1551-4.1 with active high shutdown logic. The two boards are otherwise identical. The circuit operates with input voltages of 4.5V to 6.5V. Output voltage is $-4.1V \pm 5\%$ with load currents from 0mA to 10mA. Component values, vendors and the PC board layout are recommended by Linear Technology. In many cases the layout can be copied exactly onto the system PCB.

Hook-Up

Connect the input power supply to the V_{CC} (E3) and GND (E5) terminals on the right side of the board. Connect the

output load to V_{OUT} (E4) and GND (E2) terminals on the left side of the board. Shunt connector at JPR1 should be in the left position to turn on a DC092-A (LTC1550-4.1) board; the right position to turn on a DC092-B (LTC1551-4.1). Noise and output ripple measurements are made at the female BNC socket (J1) on the demo board. Connect J1 to an oscilloscope or spectrum analyzer input with a straight BNC male-to-male adapter (Figure 5, item 4) or a short BNC male-to-male cable. For best results, please refer to the section titled Ripple and Noise Measurement.

LTC1550/LTC1551 Operation

The LTC1550/LTC1551's internal circuitry contains a switched capacitor inverting charge pump and a linear post regulator, as shown in Figure 2. The charge pump is driven by an internal clock, which typically runs at 900kHz. Operating at this frequency helps to minimize the size of the

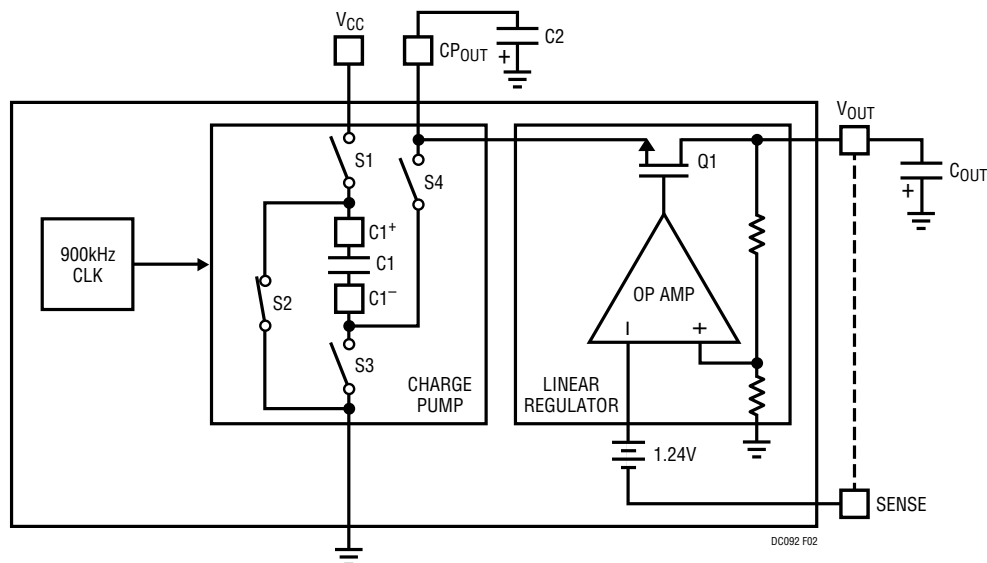

Figure 2. Block Diagram of the LTC1550/LTC1551

OPERATION

external components and places any noise out of the 400kHz to 600kHz IF band that is commonly used by portable radio frequency systems.

At the beginning of each clock cycle, capacitor C1 is charged to V_{CC} by S1 and S3. At the next clock edge, S1 and S3 open and S2 and S4 close. This connects C1+ to ground and the charge in C1 is transferred to C2 through S4, pulling CP_{OUT} to a negative voltage. As the charge pump continues to run, CP_{OUT} approaches a voltage equal to $-V_{CC}$.

The voltage at V_{OUT} is regulated from CP_{OUT} by the internal linear regulator. A divided version of the output voltage at SENSE is compared to the internal reference voltage by the internal feedback amplifier. The output of the feedback amplifier controls the gate of the series pass transistor Q1 in a negative feedback loop. As the output voltage changes due to changes in output load current or input ripple voltage, the feedback loop adjusts the gate drive at Q1 to keep the output voltage at a constant level. This loop is able to

reject virtually all of the noise generated by the charge pump circuitry, resulting in output noise below $1mV_{P-P}$ with a proper PCB design.

DC092 Performance

DC092 is a good example of layout that minimizes output noise and ripple in an LTC1550/LTC1551 design. The output ripple is typically below 1mV with output loads between 0mA and 10mA (see V_{OUT} Output Noise and Ripple).

Figure 3 shows the output spectrum over a range of 100kHz to 10MHz with $V_{CC} = 5V$, $I_{OUT} = 5mA$. The fundamental switching noise is less than $3\mu V$ and all related harmonics quickly drop into the spectrum analyzer's noise floor.

Figure 4 shows a plot of low frequency spot noise (1kHz to 100kHz). Throughout the audio range the noise is about 600 to $700nV/\sqrt{Hz}$. The broad band output noise above 20kHz is attenuated by the $10\mu F$ output capacitor.

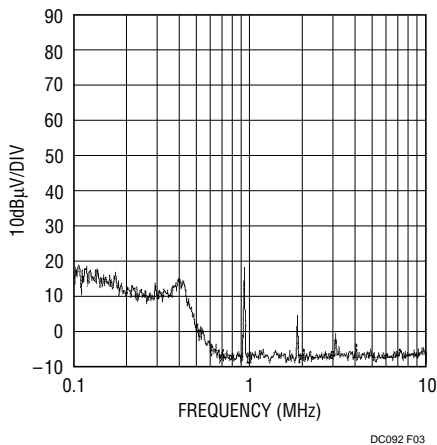

Figure 3. Output Spectrum 0.1MHz to 10MHz

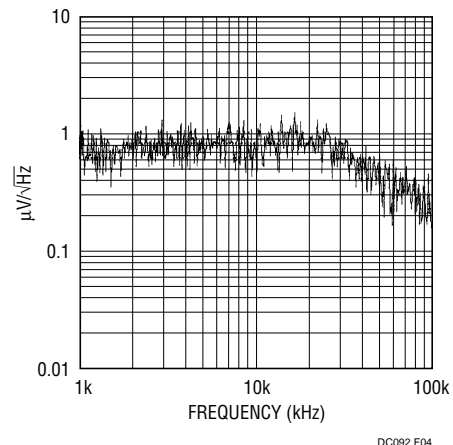

Figure 4. Output Spot Noise 1kHz to 100kHz

OPERATION

The DC092 circuit typically draws 4mA quiescent current under no load conditions. Current draw with a 5mA load and a 5V supply is typically 9mA. In shutdown, the output voltage falls to 0V and the quiescent current drops to 0.2 μ A.

Components

The LTC1550/LTC1551 require only four external components to operate: two charge pump capacitors (C1, C2), an input bypass capacitor (C3) and an output capacitor (C_{OUT}). DC092 includes an additional LC output filter to further reduce output noise and ripple.

The input bypass capacitor (C3) is very important for proper operation. It provides most of the current when charging the flying capacitor. Select a low ESR type and mount as close to the LTC1550/LTC1551 as possible. Select C3's value to be significantly larger than the flying capacitor (C1) to prevent excessive ripple at V_{CC} when the charge pump is heavily loaded. It is often convenient to use the same type of capacitor for C3 and C_{OUT}. The Sprague 595D106X0010A2T (10 μ F, 10V tantalum capacitor) is a small surface mount device and makes a good choice for C3 and C_{OUT}.

The charge pump capacitors, C1 and C2, are less critical since their peak currents are limited by the switches inside the LTC1550/LTC1551. Typical surface mount ceramic capacitors with a value of 0.1 μ F are recommended for C1 and C2 (see Parts List).

The output capacitor (C_{OUT}) supplies current to the load during alternate charge pump cycles and sets the output ripple

voltage. At least 4.7 μ F is required at the output to maintain loop stability. For optimum output stability over temperature with minimum output voltage ripple, a value of 10 μ F or greater is recommended.

A small 0.1 μ F ceramic capacitor can be placed in parallel with C_{OUT} to reduce the high frequency noise. LC or RC filtering at the output will also effectively reduce the ripple and noise further. The LTC1550/LTC1551's high 900kHz charge pump frequency allows effective output filtering with small valued components. The DC092 uses a small ferrite bead and a surface mount 0.1 μ F capacitor as an output filter to bring output voltage ripple and noise to below 1mV_{P-P} (see Parts List).

Ripple and Noise Measurement

Accurately measuring output noise and ripple in high speed switching circuitry like the LTC1550/LTC1551 can be challenging and error prone. The input voltage supply to the demo board should be a low noise DC source, supplied either by a battery or a well regulated DC supply. Circuit and test equipment grounds should be carefully connected to minimize ground noise and ground loops. Due to the high current paths in the LTC1550/LTC1551 internal charge pump, minor potential differences between the tested circuit and the measuring instrument (typically an oscilloscope or a spectrum analyzer) can cause ground currents in the measuring probe and induce significant voltage errors in the measurement.

OPERATION

Figure 5 shows a typical 10X passive probe and accessories. The use of the ground lead (item 2) and the retractable hook tip (item 6) for measurement should be avoided. This is because the unshielded probe body makes a remarkably efficient antenna at the 900kHz switching frequency of the LTC1550/LTC1551, introducing significant additional noise (as well as the local all talk AM radio station signal) into the measurement. A better choice is to attach a bayonet ground clip (item 3) to the probe tip and take the measurement directly across the output capacitor, C_{OUT} . A BNC-to-probe tip adapter (item 5) can also be used to connect the probe to the BNC socket (J1) on the demo board.

Similar results are obtained by using a 50Ω or 75Ω coaxial BNC male-to-male cable to connect J1 on the demo board to the oscilloscope's BNC input. The length of the cable should be as short as possible. Very good results are obtained by connecting J1 on the demo board to the

oscilloscope's BNC input through a straight BNC male-to-male adapter (item 4). Either of these connections provide a good measurement to allow an accurate assessment of the DC092's circuit performance.

Very high quality measurements are obtained with active probes designed specifically for the analyzer or oscilloscope used. Active probes maintain a high input impedance throughout their frequency range and minimize disturbance to the tested circuit. They also provide accurate and consistent measurement results. The output spectrum and spot noise plots shown in Figures 3 and 4 were taken with an HP41800A active probe and an HP4195A spectrum analyzer. The drawback of this method is that the active probe is more costly than a BNC connector or a passive probe. The active probe must also be properly matched to the analyzer or oscilloscope to ensure accurate results.



ITEM	DESCRIPTION
1	Probe Body
2	Ground Lead
3	Bayonet Ground Clip
4	BNC Male-to-Male Adapter
5	BNC-to-Probe Tip Adapter
6	Retractable Hook Tip

Figure 5: Probe and BNC Accessories

PCB LAYOUT AND FILM

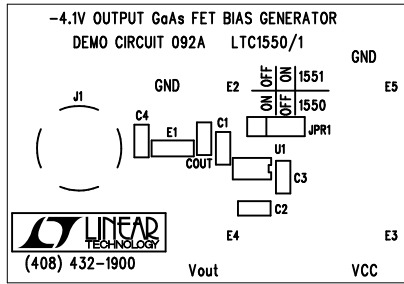

Component Side Silkscreen

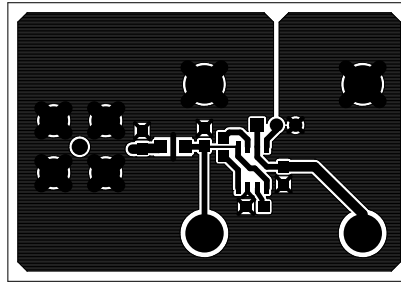

Component Side

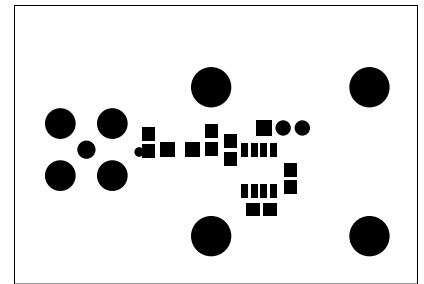

Component Side Solder Mask

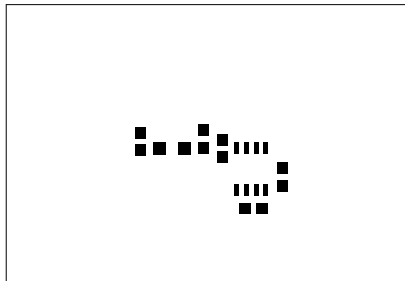

Pastemask

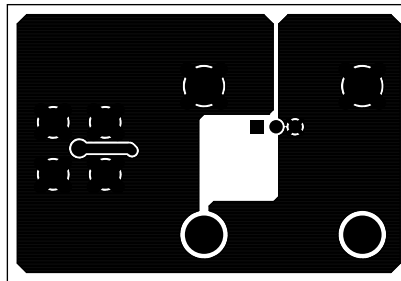

Solder Side

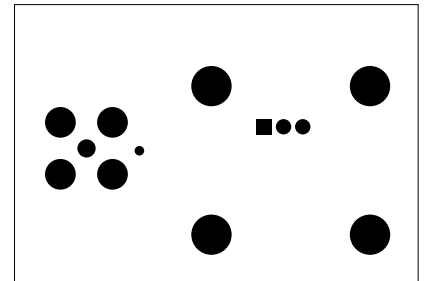

Solder Side Solder Mask

DEMO MANUAL DC092

GaAsFET BIAS GENERATOR

PC FAB DRAWING

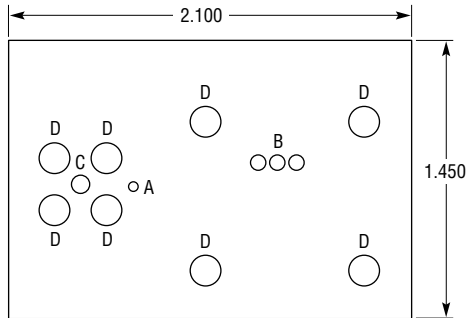

NOTES:

1. ALL DIMENSIONS ARE IN INCHES
2. MATERIAL: FR4 OR EQUIVALENT EPOXY, 2 OZ COPPER CLAD THICKNESS 0.061 ±0.006 TOTAL OF 2 LAYERS
3. FINISH: ALL PLATED HOLES 0.001 MIN/0.0015 MAX COPPER PLATE ELECTRODEPOSITED TIN-LEAD COMPOSITION BEFORE REFLOW, SOLDER MASK OVER BARE COPPER (SMOBC)
4. SOLDER MASK: BOTH SIDES USING GREEN PC-401 OR EQUIVALENT
5. SILKSCREEN: WHITE NONCONDUCTIVE INK BOTH SIDES
6. SCORING:

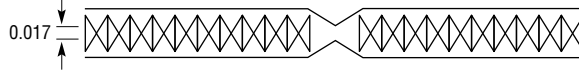

SYMBOL	DIAMETER	NUMBER OF HOLES
A	0.025	1
B	0.040	3
C	0.050	1
D	0.095	8
TOTAL HOLES		13

DC092 FAB

Компания «Океан Электроники» предлагает заключение долгосрочных отношений при поставках импортных электронных компонентов на взаимовыгодных условиях!

Наши преимущества:

- Поставка оригинальных импортных электронных компонентов напрямую с производств Америки, Европы и Азии, а так же с крупнейших складов мира;
- Широкая линейка поставок активных и пассивных импортных электронных компонентов (более 30 млн. наименований);
- Поставка сложных, дефицитных, либо снятых с производства позиций;
- Оперативные сроки поставки под заказ (от 5 рабочих дней);
- Экспресс доставка в любую точку России;
- Помощь Конструкторского Отдела и консультации квалифицированных инженеров;
- Техническая поддержка проекта, помощь в подборе аналогов, поставка прототипов;
- Поставка электронных компонентов под контролем ВП;
- Система менеджмента качества сертифицирована по Международному стандарту ISO 9001;
- При необходимости вся продукция военного и аэрокосмического назначения проходит испытания и сертификацию в лаборатории (по согласованию с заказчиком);
- Поставка специализированных компонентов военного и аэрокосмического уровня качества (Xilinx, Altera, Analog Devices, Intersil, Interpoint, Microsemi, Actel, Aeroflex, Peregrine, VPT, Syfer, Eurofarad, Texas Instruments, MS Kennedy, Miteq, Cobham, E2V, MA-COM, Hittite, Mini-Circuits, General Dynamics и др.);

Компания «Океан Электроники» является официальным дистрибьютором и эксклюзивным представителем в России одного из крупнейших производителей разъемов военного и аэрокосмического назначения «JONHON», а так же официальным дистрибьютором и эксклюзивным представителем в России производителя высокотехнологичных и надежных решений для передачи СВЧ сигналов «FORSTAR».



JONHON

«JONHON» (основан в 1970 г.)

Разъемы специального, военного и аэрокосмического назначения:

(Применяются в военной, авиационной, аэрокосмической, морской, железнодорожной, горно- и нефтедобывающей отраслях промышленности)

«FORSTAR» (основан в 1998 г.)

ВЧ соединители, коаксиальные кабели, кабельные сборки и микроволновые компоненты:

(Применяются в телекоммуникациях гражданского и специального назначения, в средствах связи, РЛС, а так же военной, авиационной и аэрокосмической отраслях промышленности).



Телефон: 8 (812) 309-75-97 (многоканальный)

Факс: 8 (812) 320-03-32

Электронная почта: ocean@oceanchips.ru

Web: <http://oceanchips.ru/>

Адрес: 198099, г. Санкт-Петербург, ул. Калинина, д. 2, корп. 4, лит. А