

This document is the property of Amphenol Corporation and is delivered on the express condition that it not be disclosed, reproduced or used, in whole or in part, for manufacture or sale by anyone other than Amphenol Corporation without its prior consent, and that no right is granted to disclose or to use any information in this document.

The marking on this product doesn't contain environmental hazardous materials per Material Specification 55-00259 for Sony GP compliant or per directive 2011/65/EU for RoHS compliant.

ORIGINAL

REVISIONS				
SYM	ECN No.	DESCRIPTION	DATE	APPROVED
A	NE-14096	RELEASE TO PRODUCTION	05/21/2014	Arron Lin
B	NE-15016	COMBINE DRAWING FOR PACKAGE AND TAIL OPTIONS.	02/02/2015	Arron Lin
C	NE-16117	ADDED METAL BOARDLOCK OPTION	05/13/2016	Roger Tsai



NOTES:

- MATERIAL:
 - HOUSING: HIGH TEMPERATURE THERMAL PLASTIC, LCP, UL94V-0, COLOR: BLACK.
 - TERMINAL: HIGH PERFORMANCE COPPER ALLOY.
 - METAL BOARDLOCK: COPPER ALLOY.
- FINISH:
 - TERMINAL:
 - CONTACT AREA: SELECTIVE PLATING;
 - SOLDERING AREA: MATTE TIN PLATING 100 μ THICKNESS MIN.;
 - UNDER PLATING: NICKEL PLATING 50 μ THICKNESS MIN. OVERALL.
 - METAL BOARDLOCK:
 - MATTE TIN PLATING 100 μ THICKNESS MIN.;
 - UNDER PLATING: NICKEL PLATING 50 μ THICKNESS MIN. OVERALL.
- PACKING IS PER AMTA PACKING SPECIFICATION PKS-0001.
- THIS PRODUCT DOESN'T CONTAIN ENVIRONMENTAL HAZARDOUS PER DIRECTIVE 2011/65/EU FOR RoHS COMPLIANT.
- PRODUCT SPECIFICATION REFER TO : PS-7528
- TO ENSURE CURRENT RATING CAPABILITY, PLEASE ADOPT TOTAL SOLUTION. (G88MPH CABLE HOUSING SERIES WITH G88MPC CABLE TERMINAL SERIES)



PART NO. G88MPBXXOX2XXEU

No. OF CIRCUIT

- DIM A /PACKING OPTIONS/METAL BOARDLOCK
- C1: 2.10mm/TRAY/ W/O METAL BOARDLOCK
 - C : 3.20mm/TRAY/ W/O METAL BOARDLOCK
 - C3: 2.10mm/TRAY/ W/METAL BOARDLOCK
 - C4: 3.20mm/TRAY/ W/METAL BOARDLOCK
 - 1R: 2.10mm/T&R/ W/O METAL BOARDLOCK
 - 2R: 3.20mm/T&R/ W/O METAL BOARDLOCK
 - 3R: 2.10mm/T&R/ W/METAL BOARDLOCK
 - 4R: 3.20mm/T&R/ W/METAL BOARDLOCK

CONTACT FINISH

- 0: MATTE TIN (OVERALL)
- UNDER PLATING NICKEL
- 50 μ THICKNESS MIN
- 1: FLASH GOLD (OVERALL)
- 2: 15 μ GOLD
- 3: 30 μ GOLD

28.70	33.0	39.65	12
25.70	30.0	36.65	11
22.70	27.0	33.65	10
19.70	24.0	30.65	09
16.70	21.0	27.65	08
13.70	18.0	24.65	07
10.70	15.0	21.65	06
7.70	12.0	18.65	05
4.70	9.0	15.65	04
NA	6.0	12.65	03
NA	3.0	9.65	02
C	A	B	POS.



PCB LAYOUT:COMPONENT SIDE
RECOMMENDED PCB THICKNESS:1.57
4-12 CIRCUIT HEADERS

TOLERANCE	APPROVALS	DATE	TITLE
X. ±0.30	DRAWN Aqua Chou	05/13/2016	G88MP SERIES MICRO POWER PLUS 3.0 PITCH S/R R/A DIP TYPE
X.X ±0.20	CHECKED Roger Tsai	05/13/2016	
X.XX ±0.10	APPROVED Roger Tsai	05/13/2016	
ANGULAR ±1°	DWG TYPE CUST DWG	PROJECT CODE PHD	
UNLESS OTHERWISE SPECIFIED			

UNIT	SIZE	SHEET
mm	A3	1 OF 5
SCALE NA		

<p>Amphenol Corporation Amphenol Taiwan Corporation</p>		PART No.	G88MPBXXOX2XXEU
		DWG No.	G88MPBXXOX2XXEU
		REV.	C

This document is the property of Amphenol Corporation and is delivered on the express condition that is not to be disclosed, reproduced or used, in whole or in part, for manufacture or sale by anyone other than Amphenol Corporation without its prior consent, and that no right is granted to disclose or to use any information in this document.

The marking on this product doesn't contain environmental hazardous materials per Material Specification SS-00259 for Sony GP compliant or per directive 2011/65/EU for RoHS compliant.



ORIGINAL



REVISIONS				
SYM	ECN No.	DESCRIPTION	DATE	APPROVED
A	NE-14096	RELEASE TO PRODUCTION	05/21/2014	Arron Lin
B	NE-15016	COMBINE DRAWING FOR PACKAGE AND TAIL OPTIONS.	02/02/2015	Arron Lin
C	NE-16117	ADDED METAL BOARDLOCK OPTION	05/13/2016	Roger Tsai



2 POS

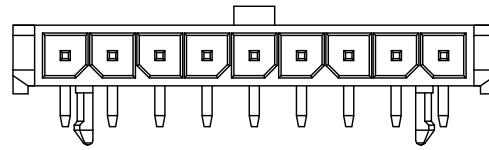

9 POS

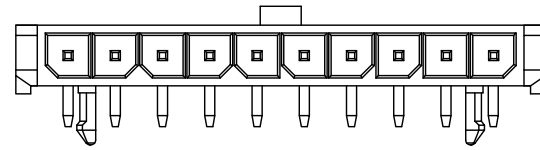

10 POS

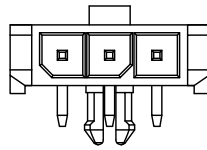

3 POS

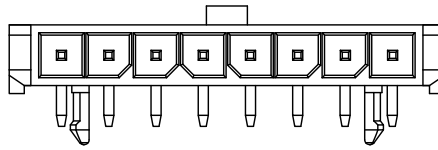

8 POS

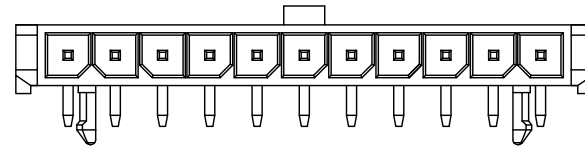

11 POS

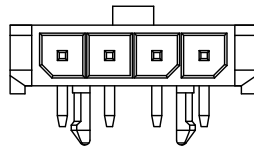

4 POS

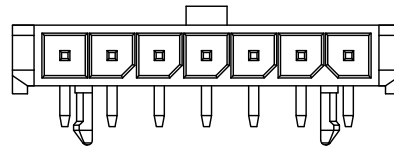

7 POS

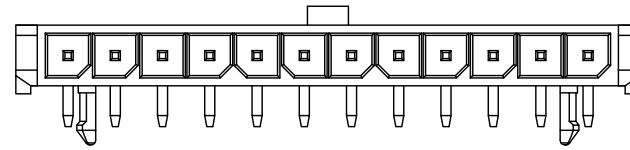

12 POS

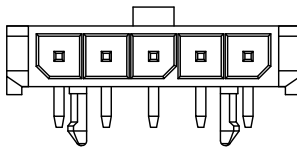

5 POS

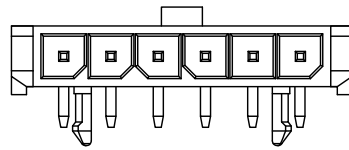

6 POS

METAL BOARDLOCK OPTION FOR POS2~12

TOLERANCE		APPROVALS		DATE	TITLE		Amphenol®				
X.		DRAWN	Aqua Chou	05/13/2016	G88MP SERIES MICRO POWER PLUS 3.0 PITCH S/R R/A DIP TYPE		Amphenol Corporation Amphenol Taiwan Corporation				
X.X	±0.30	CHECKED	Roger Tsai	05/13/2016							
X.XXX	±0.20	APPROVED	Roger Tsai	05/13/2016							
X.XXX	±0.10	DWG TYPE	CUST DWG	PROJECT CODE	PHD	UNIT	mm	SIZE	A3	PART No.	G88MPBXX0X2XXEU
ANGULAR	±1°					SCALE	NA	SHEET	2 OF 5	DWG No.	G88MPBXX0X2XXEU
UNLESS OTHERWISE SPECIFIED										REV.	C

This document is the property of Amphenol Corporation and is delivered on the express condition that is not to be disclosed, reproduced or used, in whole or in part, for manufacture or sale by anyone other than Amphenol Corporation without its prior consent, and that no right is granted to disclose or to use any information in this document.

The marking on this product doesn't contain environmental hazardous materials per Material Specification 55-00259 for Sony GP compliant or per directive 2011/65/EU for RoHS compliant.



ORIGINAL



REVISIONS				
SYM	ECN No.	DESCRIPTION	DATE	APPROVED
A	NE-14096	RELEASE TO PRODUCTION	05/21/2014	Arron Lin
B	NE-15016	COMBINE DRAWING FOR PACKAGE AND TAIL OPTIONS.	02/02/2015	Arron Lin
C	NE-16117	ADDED METAL BOARDLOCK OPTION	05/13/2016	Roger Tsai

POS.	BOARD-MOUNT P/N	CABLE HOUSING P/N	CABLE TERMINAL P/N	AWG NO.	PLATING OPTIONS
02	G88MPB020X2XXEU	G88MPH0221CEU	G88MPCX232CEU	AWG#16~18	0: TIN 100u" ; 1: FLASH GOLD
			G88MPCX332CEU	AWG#20~30	2: 15u" GOLD ; 3: 30u" GOLD
03	G88MPB030X2XXEU	G88MPH0321CEU	G88MPCX232CEU	AWG#16~18	0: TIN 100u" ; 1: FLASH GOLD
			G88MPCX332CEU	AWG#20~30	2: 15u" GOLD ; 3: 30u" GOLD
04	G88MPB040X2XXEU	G88MPH0421CEU	G88MPCX232CEU	AWG#16~18	0: TIN 100u" ; 1: FLASH GOLD
			G88MPCX332CEU	AWG#20~30	2: 15u" GOLD ; 3: 30u" GOLD
05	G88MPB050X2XXEU	G88MPH0521CEU	G88MPCX232CEU	AWG#16~18	0: TIN 100u" ; 1: FLASH GOLD
			G88MPCX332CEU	AWG#20~30	2: 15u" GOLD ; 3: 30u" GOLD
06	G88MPB060X2XXEU	G88MPH0621CEU	G88MPCX232CEU	AWG#16~18	0: TIN 100u" ; 1: FLASH GOLD
			G88MPCX332CEU	AWG#20~30	2: 15u" GOLD ; 3: 30u" GOLD
07	G88MPB070X2XXEU	G88MPH0721EU	G88MPCX232CEU	AWG#16~18	0: TIN 100u" ; 1: FLASH GOLD
			G88MPCX332CEU	AWG#20~30	2: 15u" GOLD ; 3: 30u" GOLD
08	G88MPB080X2XXEU	G88MPH0821CEU	G88MPCX232CEU	AWG#16~18	0: TIN 100u" ; 1: FLASH GOLD
			G88MPCX332CEU	AWG#20~30	2: 15u" GOLD ; 3: 30u" GOLD
09	G88MPB090X2XXEU	G88MPH0921CEU	G88MPCX232CEU	AWG#16~18	0: TIN 100u" ; 1: FLASH GOLD
			G88MPCX332CEU	AWG#20~30	2: 15u" GOLD ; 3: 30u" GOLD
10	G88MPB100X2XXEU	G88MPH1021CEU	G88MPCX232CEU	AWG#16~18	0: TIN 100u" ; 1: FLASH GOLD
			G88MPCX332CEU	AWG#20~30	2: 15u" GOLD ; 3: 30u" GOLD
11	G88MPB110X2XXEU	G88MPH1121CEU	G88MPCX232CEU	AWG#16~18	0: TIN 100u" ; 1: FLASH GOLD
			G88MPCX332CEU	AWG#20~30	2: 15u" GOLD ; 3: 30u" GOLD
12	G88MPB120X2XXEU	G88MPH1221CEU	G88MPCX232CEU	AWG#16~18	0: TIN 100u" ; 1: FLASH GOLD
			G88MPCX332CEU	AWG#20~30	2: 15u" GOLD ; 3: 30u" GOLD

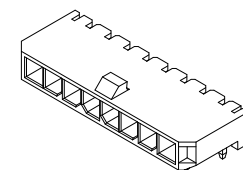

AMPHENOL BOARD-MOUNT

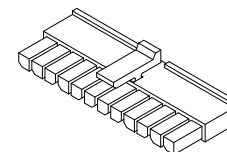

AMPHENOL CABLE HOUSING

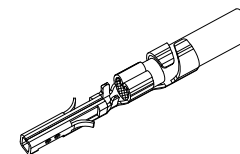

AMPHENOL CABLE TERMINAL

NOTE:
TO ENSURE CURRENT RATING CAPABILITY,
PLEASE ADOPT TOTAL SOLUTION.
(G88MPH CABLE HOUSING SERIES WITH
G88MPC CABLE TERMINAL SERIES)

TOLERANCE		APPROVALS		DATE	TITLE		Amphenol®							
X.		DRAWN	Aqua Chou	05/13/2016	G88MP SERIES MICRO POWER PLUS 3.0 PITCH S/R R/A DIP TYPE		Amphenol Corporation Amphenol Taiwan Corporation							
X.X	±0.30	CHECKED	Roger Tsai	05/13/2016										
X.XX	±0.20	APPROVED	Roger Tsai	05/13/2016										
X.XXX	±0.10						UNIT	mm	SIZE	A3	PART No.	G88MPBXX0X2XXEU		
ANGULAR	±1°						SCALE	NA	SHEET	3 OF 5	DWG No.	G88MPBXX0X2XXEU	REV.	C
UNLESS OTHERWISE SPECIFIED		DWG TYPE		CUST DWG	PROJECT CODE		PHD							

This document is the property of Amphenol Corporation and is delivered on the express condition that is not to be disclosed, reproduced or used, in whole or in part, for manufacture or sale by anyone other than Amphenol Corporation without its prior consent, and that no right is granted to disclose or to use any information in this document.

The marking on this product doesn't contain environmental hazardous materials per Material Specification SS-00259 for Sony GP compliant or per directive 2011/65/EU for RoHS compliant.



ORIGINAL



REVISIONS				
SYM	ECN No.	DESCRIPTION	DATE	APPROVED
A	NE-14096	RELEASE TO PRODUCTION	05/21/2014	Arron Lin
B	NE-15016	COMBINE DRAWING FOR PACKAGE AND TAIL OPTIONS.	02/02/2015	Arron Lin
C	NE-16117	ADDED METAL BOARDLOCK OPTION	05/13/2016	Roger Tsai



POS	PCS/TRAY	PCS/CARTON
02	574	8610
03	434	6510
04	350	5250
05	294	4410
06	252	3780
07	224	3360
08	196	2940
09	182	2730
10	154	2310
11	140	2100
12	140	2100

TOLERANCE		APPROVALS		DATE	TITLE		Amphenol®							
X.		DRAWN	Aqua Chou	05/13/2016	G88MP SERIES MICRO POWER PLUS 3.0 PITCH S/R R/A DIP TYPE		Amphenol Corporation Amphenol Taiwan Corporation							
X.X	±0.30	CHECKED	Roger Tsai	05/13/2016										
X.XX	±0.20	APPROVED	Roger Tsai	05/13/2016										
X.XXX	±0.10						UNIT	mm	SIZE	A3	PART No.	G88MPBXX0X2XXEU		
ANGULAR	±1°	DWG TYPE		CUST DWG	PROJECT CODE	PHD	SCALE	NA	SHEET	4 OF 5	DWG No.	G88MPBXX0X2XXEU	REV.	C
UNLESS OTHERWISE SPECIFIED														

This document is the property of Amphenol Corporation and is delivered on the express condition that is not to be disclosed, reproduced or used, in whole or in part, for manufacture or sale by anyone other than Amphenol Corporation without its prior consent, and that no right is granted to disclose or to use any information in this document.

The marking on this product doesn't contain environmental hazardous materials per Material Specification SS-00259 for Sony GP compliant or per directive 2011/65/EU for RoHS compliant.



ORIGINAL



REVISIONS				
SYM	ECN No.	DESCRIPTION	DATE	APPROVED
A	NE-14096	RELEASE TO PRODUCTION	05/21/2014	Arron Lin
B	NE-15016	COMBINE DRAWING FOR PACKAGE AND TAIL OPTIONS.	02/02/2015	Arron Lin
C	NE-16117	ADDED METAL BOARDLOCK OPTION	05/13/2016	Roger Tsai



POS	W	PCS/REEL	PCS/CARTON
12	56	400	1200
11	56	400	1200
10	56	400	1200
09	56	400	1200
08	44	400	1600
07	44	400	1600
06	44	400	1600
05	32	400	2000
04	32	400	2000
03	24	400	2800
02	24	400	2800

P/N :
QTY : XX
P/O : XXX-XXXXXX-XXX
DATE : XX / XX / XXXX MM / DD / YYYY
G.W : XX KG RoHS
Amphenol Taiwan Corporation
LABEL 1 & LABEL 2

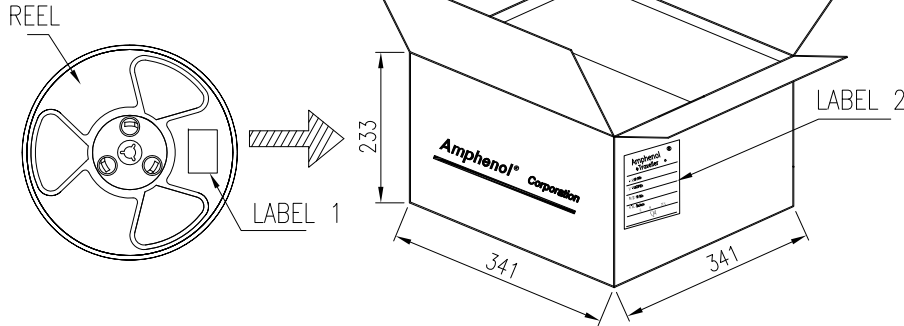

TOLERANCE		APPROVALS		DATE		TITLE			Amphenol®		
X.		DRAWN	Aqua Chou		05/13/2016	G88MP SERIES MICRO POWER PLUS 3.0 PITCH S/R R/A DIP TYPE			Amphenol Corporation Amphenol Taiwan Corporation		
X.X	±0.30	CHECKED	Roger Tsai		05/13/2016						
X.XX	±0.20	APPROVED	Roger Tsai		05/13/2016						
X.XXX	±0.10					UNIT mm		SIZE A3	PART No. G88MPBXX0X2XXEU		
ANGULAR	±1°	DWG TYPE CUST DWG		PROJECT CODE PHD		SCALE NA		SHEET 5 OF 5	DWG No. G88MPBXX0X2XXEU		REV. C

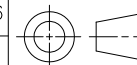

Компания «Океан Электроники» предлагает заключение долгосрочных отношений при поставках импортных электронных компонентов на взаимовыгодных условиях!

Наши преимущества:

- Поставка оригинальных импортных электронных компонентов напрямую с производств Америки, Европы и Азии, а так же с крупнейших складов мира;
- Широкая линейка поставок активных и пассивных импортных электронных компонентов (более 30 млн. наименований);
- Поставка сложных, дефицитных, либо снятых с производства позиций;
- Оперативные сроки поставки под заказ (от 5 рабочих дней);
- Экспресс доставка в любую точку России;
- Помощь Конструкторского Отдела и консультации квалифицированных инженеров;
- Техническая поддержка проекта, помощь в подборе аналогов, поставка прототипов;
- Поставка электронных компонентов под контролем ВП;
- Система менеджмента качества сертифицирована по Международному стандарту ISO 9001;
- При необходимости вся продукция военного и аэрокосмического назначения проходит испытания и сертификацию в лаборатории (по согласованию с заказчиком);
- Поставка специализированных компонентов военного и аэрокосмического уровня качества (Xilinx, Altera, Analog Devices, Intersil, Interpoint, Microsemi, Actel, Aeroflex, Peregrine, VPT, Syfer, Eurofarad, Texas Instruments, MS Kennedy, Miteq, Cobham, E2V, MA-COM, Hittite, Mini-Circuits, General Dynamics и др.);

Компания «Океан Электроники» является официальным дистрибьютором и эксклюзивным представителем в России одного из крупнейших производителей разъемов военного и аэрокосмического назначения «JONHON», а так же официальным дистрибьютором и эксклюзивным представителем в России производителя высокотехнологичных и надежных решений для передачи СВЧ сигналов «FORSTAR».



JONHON

«JONHON» (основан в 1970 г.)

Разъемы специального, военного и аэрокосмического назначения:

(Применяются в военной, авиационной, аэрокосмической, морской, железнодорожной, горно- и нефтедобывающей отраслях промышленности)

«FORSTAR» (основан в 1998 г.)

ВЧ соединители, коаксиальные кабели,
кабельные сборки и микроволновые компоненты:

(Применяются в телекоммуникациях гражданского и специального назначения, в средствах связи, РЛС, а так же военной, авиационной и аэрокосмической отраслях промышленности).



Телефон: 8 (812) 309-75-97 (многоканальный)

Факс: 8 (812) 320-03-32

Электронная почта: ocean@oceanchips.ru

Web: <http://oceanchips.ru/>

Адрес: 198099, г. Санкт-Петербург, ул. Калинина, д. 2, корп. 4, лит. А