

This document is the property of Amphenol Corporation and is delivered on the express condition that it not be disclosed, reproduced or used, in whole or in part, for manufacture or sale by anyone other than Amphenol Corporation without its prior consent, and that no right is granted to disclose or to use any information in this document.

The marking on this product doesn't contain environmental hazardous materials per Material Specification 55-00259 for Sony GP compliant or per directive 2011/65/EU for RoHS compliant.

ORIGINAL

| REVISIONS | | | | |
|-----------|----------|---|------------|------------|
| SYM | ECN No. | DESCRIPTION | DATE | APPROVED |
| A | NE-14096 | RELEASE TO PRODUCTION | 05/21/2014 | Arron Lin |
| B | NE-15016 | COMBINE DRAWING FOR PACKAGE AND TAIL OPTIONS. | 02/02/2015 | Arron Lin |
| C | NE-16117 | ADDED METAL BOARDLOCK OPTION | 05/13/2016 | Roger Tsai |



NOTES:

- MATERIAL:
 - HOUSING: HIGH TEMPERATURE THERMAL PLASTIC, LCP, UL94V-0, COLOR: BLACK.
 - TERMINAL: HIGH PERFORMANCE COPPER ALLOY.
 - METAL BOARDLOCK: COPPER ALLOY.
- FINISH:
 - TERMINAL:
 - CONTACT AREA: SELECTIVE PLATING;
 - SOLDERING AREA: MATTE TIN PLATING 100 μ" THICKNESS MIN.;
 - UNDER PLATING: NICKEL PLATING 50 μ" THICKNESS MIN. OVERALL.
 - METAL BOARDLOCK:
 - MATTE TIN PLATING 100 μ" THICKNESS MIN.;
 - UNDER PLATING: NICKEL PLATING 50 μ" THICKNESS MIN. OVERALL.
- PACKING IS PER AMTA PACKING SPECIFICATION PKS-0001.
- THIS PRODUCT DOESN'T CONTAIN ENVIRONMENTAL HAZARDOUS PER DIRECTIVE 2011/65/EU FOR RoHS COMPLIANT.
- PRODUCT SPECIFICATION REFER TO : PS-7528
- TO ENSURE CURRENT RATING CAPABILITY, PLEASE ADOPT TOTAL SOLUTION. (G88MPH CABLE HOUSING SERIES WITH G88MPC CABLE TERMINAL SERIES)



PART NO. G88MPBXXOX2XXEU

No. OF CIRCUIT

- DIM A /PACKING OPTIONS/METAL BOARDLOCK
- C1: 2.10mm/TRAY/ W/O METAL BOARDLOCK
 - C : 3.20mm/TRAY/ W/O METAL BOARDLOCK
 - C3: 2.10mm/TRAY/ W/METAL BOARDLOCK
 - C4: 3.20mm/TRAY/ W/METAL BOARDLOCK
 - 1R: 2.10mm/T&R/ W/O METAL BOARDLOCK
 - 2R: 3.20mm/T&R/ W/O METAL BOARDLOCK
 - 3R: 2.10mm/T&R/ W/METAL BOARDLOCK
 - 4R: 3.20mm/T&R/ W/METAL BOARDLOCK

CONTACT FINISH

- 0: MATTE TIN (OVERALL)
- UNDER PLATING NICKEL
- 50 μ" THICKNESS MIN
- 1: FLASH GOLD (OVERALL)
- 2: 15 μ" GOLD
- 3: 30 μ" GOLD

| | | | |
|-------|------|-------|------|
| 28.70 | 33.0 | 39.65 | 12 |
| 25.70 | 30.0 | 36.65 | 11 |
| 22.70 | 27.0 | 33.65 | 10 |
| 19.70 | 24.0 | 30.65 | 09 |
| 16.70 | 21.0 | 27.65 | 08 |
| 13.70 | 18.0 | 24.65 | 07 |
| 10.70 | 15.0 | 21.65 | 06 |
| 7.70 | 12.0 | 18.65 | 05 |
| 4.70 | 9.0 | 15.65 | 04 |
| NA | 6.0 | 12.65 | 03 |
| NA | 3.0 | 9.65 | 02 |
| C | A | B | POS. |



PCB LAYOUT:COMPONENT SIDE
RECOMMENDED PCB THICKNESS:1.57
4-12 CIRCUIT HEADERS

| TOLERANCE | APPROVALS | DATE | TITLE | | Amphenol® | |
|----------------------------|---------------------|------------------|--|--------------|---|--------|
| X. ±0.30 | DRAWN Aqua Chou | 05/13/2016 | G88MP SERIES MICRO POWER PLUS 3.0 PITCH S/R R/A DIP TYPE | | Amphenol Corporation Amphenol Taiwan Corporation | |
| X.X ±0.20 | CHECKED Roger Tsai | 05/13/2016 | | | | |
| X.XXX ±0.10 | APPROVED Roger Tsai | 05/13/2016 | | | | |
| ANGULAR ±1° | | | UNIT mm | SIZE A3 | PART No. G88MPBXXOX2XXEU | |
| UNLESS OTHERWISE SPECIFIED | DWG TYPE CUST DWG | PROJECT CODE PHD | SCALE NA | SHEET 1 OF 5 | DWG No. G88MPBXXOX2XXEU | REV. C |

This document is the property of Amphenol Corporation and is delivered on the express condition that is not to be disclosed, reproduced or used, in whole or in part, for manufacture or sale by anyone other than Amphenol Corporation without its prior consent, and that no right is granted to disclose or to use any information in this document.

The marking on this product doesn't contain environmental hazardous materials per Material Specification SS-00259 for Sony GP compliant or per directive 2011/65/EU for RoHS compliant.



ORIGINAL



| REVISIONS | | | | |
|-----------|----------|---|------------|------------|
| SYM | ECN No. | DESCRIPTION | DATE | APPROVED |
| A | NE-14096 | RELEASE TO PRODUCTION | 05/21/2014 | Arron Lin |
| B | NE-15016 | COMBINE DRAWING FOR PACKAGE AND TAIL OPTIONS. | 02/02/2015 | Arron Lin |
| C | NE-16117 | ADDED METAL BOARDLOCK OPTION | 05/13/2016 | Roger Tsai |

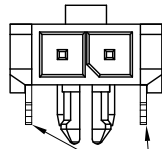

2 POS

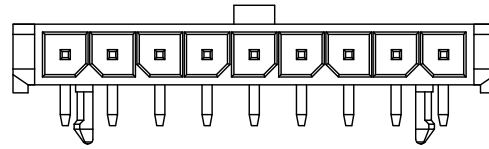

9 POS

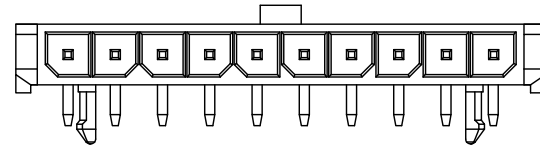

10 POS

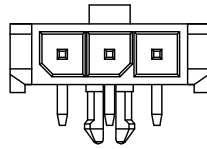

3 POS

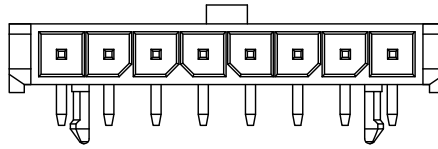

8 POS

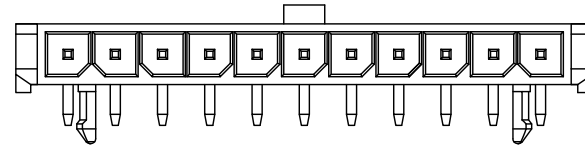

11 POS

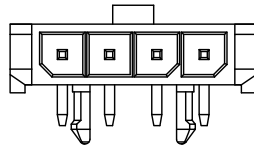

4 POS

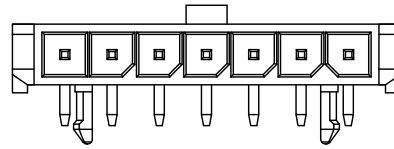

7 POS

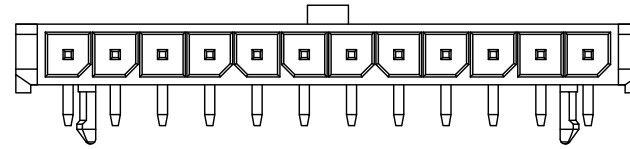

12 POS

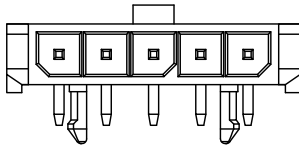

5 POS

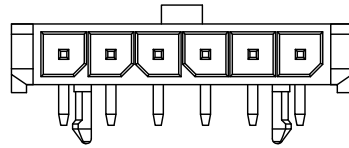

6 POS

METAL BOARDLOCK OPTION FOR POS2~12

| TOLERANCE | | APPROVALS | | DATE | TITLE | | Amphenol® | | | | |
|----------------------------|-------|-----------|------------|--------------|--|-------|---|-------|--------|----------|-----------------|
| X. | | DRAWN | Aqua Chou | 05/13/2016 | G88MP SERIES MICRO POWER PLUS 3.0 PITCH S/R R/A DIP TYPE | | Amphenol Corporation Amphenol Taiwan Corporation | | | | |
| X.X | ±0.30 | CHECKED | Roger Tsai | 05/13/2016 | | | | | | | |
| X.XXX | ±0.20 | APPROVED | Roger Tsai | 05/13/2016 | | | | | | | |
| X.XXX | ±0.10 | DWG TYPE | CUST DWG | PROJECT CODE | PHD | UNIT | mm | SIZE | A3 | PART No. | G88MPBXX0X2XXEU |
| ANGULAR | ±1° | | | | | SCALE | NA | SHEET | 2 OF 5 | DWG No. | G88MPBXX0X2XXEU |
| UNLESS OTHERWISE SPECIFIED | | | | | | | | | | REV. | C |

This document is the property of Amphenol Corporation and is delivered on the express condition that is not to be disclosed, reproduced or used, in whole or in part, for manufacture or sale by anyone other than Amphenol Corporation without its prior consent, and that no right is granted to disclose or to use any information in this document.

The marking on this product doesn't contain environmental hazardous materials per Material Specification 55-00259 for Sony GP compliant or per directive 2011/65/EU for RoHS compliant.



ORIGINAL



| REVISIONS | | | | |
|-----------|----------|---|------------|------------|
| SYM | ECN No. | DESCRIPTION | DATE | APPROVED |
| A | NE-14096 | RELEASE TO PRODUCTION | 05/21/2014 | Arron Lin |
| B | NE-15016 | COMBINE DRAWING FOR PACKAGE AND TAIL OPTIONS. | 02/02/2015 | Arron Lin |
| C | NE-16117 | ADDED METAL BOARDLOCK OPTION | 05/13/2016 | Roger Tsai |

| POS. | BOARD-MOUNT P/N | CABLE HOUSING P/N | CABLE TERMINAL P/N | AWG NO. | PLATING OPTIONS |
|------|-----------------|-------------------|--------------------|-----------|------------------------------|
| 02 | G88MPB020X2XXEU | G88MPH0221CEU | G88MPCX232CEU | AWG#16~18 | 0: TIN 100u" ; 1: FLASH GOLD |
| | | | G88MPCX332CEU | AWG#20~30 | 2: 15u" GOLD ; 3: 30u" GOLD |
| 03 | G88MPB030X2XXEU | G88MPH0321CEU | G88MPCX232CEU | AWG#16~18 | 0: TIN 100u" ; 1: FLASH GOLD |
| | | | G88MPCX332CEU | AWG#20~30 | 2: 15u" GOLD ; 3: 30u" GOLD |
| 04 | G88MPB040X2XXEU | G88MPH0421CEU | G88MPCX232CEU | AWG#16~18 | 0: TIN 100u" ; 1: FLASH GOLD |
| | | | G88MPCX332CEU | AWG#20~30 | 2: 15u" GOLD ; 3: 30u" GOLD |
| 05 | G88MPB050X2XXEU | G88MPH0521CEU | G88MPCX232CEU | AWG#16~18 | 0: TIN 100u" ; 1: FLASH GOLD |
| | | | G88MPCX332CEU | AWG#20~30 | 2: 15u" GOLD ; 3: 30u" GOLD |
| 06 | G88MPB060X2XXEU | G88MPH0621CEU | G88MPCX232CEU | AWG#16~18 | 0: TIN 100u" ; 1: FLASH GOLD |
| | | | G88MPCX332CEU | AWG#20~30 | 2: 15u" GOLD ; 3: 30u" GOLD |
| 07 | G88MPB070X2XXEU | G88MPH0721EU | G88MPCX232CEU | AWG#16~18 | 0: TIN 100u" ; 1: FLASH GOLD |
| | | | G88MPCX332CEU | AWG#20~30 | 2: 15u" GOLD ; 3: 30u" GOLD |
| 08 | G88MPB080X2XXEU | G88MPH0821CEU | G88MPCX232CEU | AWG#16~18 | 0: TIN 100u" ; 1: FLASH GOLD |
| | | | G88MPCX332CEU | AWG#20~30 | 2: 15u" GOLD ; 3: 30u" GOLD |
| 09 | G88MPB090X2XXEU | G88MPH0921CEU | G88MPCX232CEU | AWG#16~18 | 0: TIN 100u" ; 1: FLASH GOLD |
| | | | G88MPCX332CEU | AWG#20~30 | 2: 15u" GOLD ; 3: 30u" GOLD |
| 10 | G88MPB100X2XXEU | G88MPH1021CEU | G88MPCX232CEU | AWG#16~18 | 0: TIN 100u" ; 1: FLASH GOLD |
| | | | G88MPCX332CEU | AWG#20~30 | 2: 15u" GOLD ; 3: 30u" GOLD |
| 11 | G88MPB110X2XXEU | G88MPH1121CEU | G88MPCX232CEU | AWG#16~18 | 0: TIN 100u" ; 1: FLASH GOLD |
| | | | G88MPCX332CEU | AWG#20~30 | 2: 15u" GOLD ; 3: 30u" GOLD |
| 12 | G88MPB120X2XXEU | G88MPH1221CEU | G88MPCX232CEU | AWG#16~18 | 0: TIN 100u" ; 1: FLASH GOLD |
| | | | G88MPCX332CEU | AWG#20~30 | 2: 15u" GOLD ; 3: 30u" GOLD |

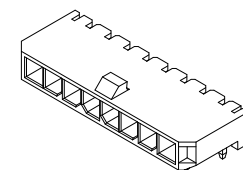

AMPHENOL BOARD-MOUNT

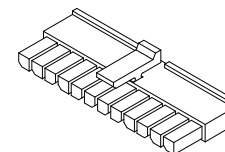

AMPHENOL CABLE HOUSING

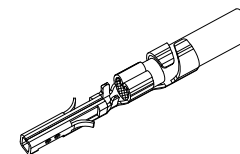

AMPHENOL CABLE TERMINAL

NOTE:
TO ENSURE CURRENT RATING CAPABILITY,
PLEASE ADOPT TOTAL SOLUTION.
(G88MPH CABLE HOUSING SERIES WITH
G88MPC CABLE TERMINAL SERIES)

| TOLERANCE | | APPROVALS | | DATE | TITLE | | Amphenol® | | | | | | | |
|----------------------------|-------|-----------|------------|------------|--|--|---|----|-------|--------|----------|-----------------|------|---|
| X. | | DRAWN | Aqua Chou | 05/13/2016 | G88MP SERIES MICRO POWER PLUS 3.0 PITCH S/R R/A DIP TYPE | | Amphenol Corporation Amphenol Taiwan Corporation | | | | | | | |
| X.X | ±0.30 | CHECKED | Roger Tsai | 05/13/2016 | | | | | | | | | | |
| X.XX | ±0.20 | APPROVED | Roger Tsai | 05/13/2016 | | | | | | | | | | |
| X.XXX | ±0.10 | | | | | | UNIT | mm | SIZE | A3 | PART No. | G88MPBXX0X2XXEU | | |
| ANGULAR | ±1° | | | | | | SCALE | NA | SHEET | 3 OF 5 | DWG No. | G88MPBXX0X2XXEU | REV. | C |
| UNLESS OTHERWISE SPECIFIED | | DWG TYPE | | CUST DWG | PROJECT CODE | | PHD | | | | | | | |

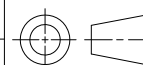

This document is the property of Amphenol Corporation and is delivered on the express condition that is not to be disclosed, reproduced or used, in whole or in part, for manufacture or sale by anyone other than Amphenol Corporation without its prior consent, and that no right is granted to disclose or to use any information in this document.

The marking on this product doesn't contain environmental hazardous materials per Material Specification SS-00259 for Sony GP compliant or per directive 2011/65/EU for RoHS compliant.



ORIGINAL



| REVISIONS | | | | |
|-----------|----------|---|------------|------------|
| SYM | ECN No. | DESCRIPTION | DATE | APPROVED |
| A | NE-14096 | RELEASE TO PRODUCTION | 05/21/2014 | Arron Lin |
| B | NE-15016 | COMBINE DRAWING FOR PACKAGE AND TAIL OPTIONS. | 02/02/2015 | Arron Lin |
| C | NE-16117 | ADDED METAL BOARDLOCK OPTION | 05/13/2016 | Roger Tsai |



| POS | PCS/TRAY | PCS/CARTON |
|-----|----------|------------|
| 02 | 574 | 8610 |
| 03 | 434 | 6510 |
| 04 | 350 | 5250 |
| 05 | 294 | 4410 |
| 06 | 252 | 3780 |
| 07 | 224 | 3360 |
| 08 | 196 | 2940 |
| 09 | 182 | 2730 |
| 10 | 154 | 2310 |
| 11 | 140 | 2100 |
| 12 | 140 | 2100 |

| TOLERANCE | | APPROVALS | | DATE | TITLE | | Amphenol® | | | | | | |
|----------------------------|-------|-----------|------------|------------|--|-------|---|-------|--------|----------|-----------------|------|---|
| X. | | DRAWN | Aqua Chou | 05/13/2016 | G88MP SERIES MICRO POWER PLUS 3.0 PITCH S/R R/A DIP TYPE | | Amphenol Corporation Amphenol Taiwan Corporation | | | | | | |
| X.X | ±0.30 | CHECKED | Roger Tsai | 05/13/2016 | | | | | | | | | |
| X.XX | ±0.20 | APPROVED | Roger Tsai | 05/13/2016 | | | | | | | | | |
| X.XXX | ±0.10 | | | | | UNIT | mm | SIZE | A3 | PART No. | G88MPBXX0X2XXEU | | |
| ANGULAR | ±1° | DWG TYPE | | CUST DWG | PROJECT CODE | SCALE | NA | SHEET | 4 OF 5 | DWG No. | G88MPBXX0X2XXEU | REV. | C |
| UNLESS OTHERWISE SPECIFIED | | | | | PHD | | | | | | | | |

This document is the property of Amphenol Corporation and is delivered on the express condition that is not to be disclosed, reproduced or used, in whole or in part, for manufacture or sale by anyone other than Amphenol Corporation without its prior consent, and that no right is granted to disclose or to use any information in this document.

The marking on this product doesn't contain environmental hazardous materials per Material Specification SS-00259 for Sony GP compliant or per directive 2011/65/EU for RoHS compliant.



ORIGINAL



| REVISIONS | | | | |
|-----------|----------|---|------------|------------|
| SYM | ECN No. | DESCRIPTION | DATE | APPROVED |
| A | NE-14096 | RELEASE TO PRODUCTION | 05/21/2014 | Arron Lin |
| B | NE-15016 | COMBINE DRAWING FOR PACKAGE AND TAIL OPTIONS. | 02/02/2015 | Arron Lin |
| C | NE-16117 | ADDED METAL BOARDLOCK OPTION | 05/13/2016 | Roger Tsai |



| POS | W | PCS/REEL | PCS/CARTON |
|-----|----|----------|------------|
| 12 | 56 | 400 | 1200 |
| 11 | 56 | 400 | 1200 |
| 10 | 56 | 400 | 1200 |
| 09 | 56 | 400 | 1200 |
| 08 | 44 | 400 | 1600 |
| 07 | 44 | 400 | 1600 |
| 06 | 44 | 400 | 1600 |
| 05 | 32 | 400 | 2000 |
| 04 | 32 | 400 | 2000 |
| 03 | 24 | 400 | 2800 |
| 02 | 24 | 400 | 2800 |

| |
|---|
| P/N : |
| QTY : XX |
| P/O : XXX-XXXXXX-XXX |
| DATE : XX / XX / XXXX MM / DD / YYYY |
| G.W : XX KG RoHS |
| Amphenol Taiwan Corporation |

LABEL 1 & LABEL 2

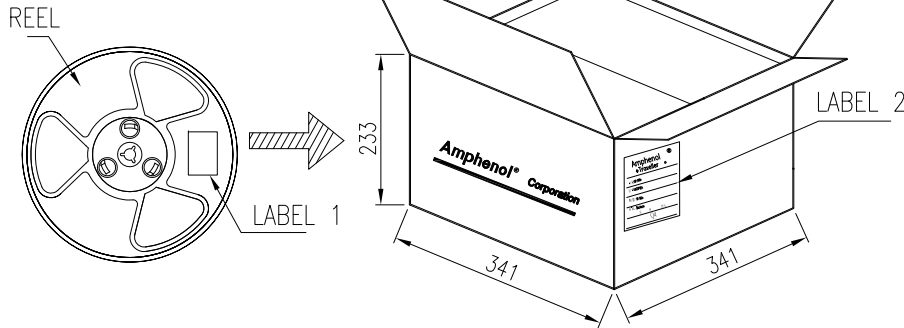

| TOLERANCE | | APPROVALS | | DATE | | TITLE | | | Amphenol® | | | | | | |
|-----------|-------|----------------------------|------------|----------|------------|--|-----|-------|---|-------|--------|----------|-----------------|------|---|
| X. | | DRAWN | Aqua Chou | | 05/13/2016 | G88MP SERIES MICRO POWER PLUS 3.0 PITCH S/R R/A DIP TYPE | | | Amphenol Corporation Amphenol Taiwan Corporation | | | | | | |
| X.X | ±0.30 | CHECKED | Roger Tsai | | 05/13/2016 | | | | | | | | | | |
| X.XX | ±0.20 | APPROVED | Roger Tsai | | 05/13/2016 | | | | | | | | | | |
| X.XXX | ±0.10 | UNLESS OTHERWISE SPECIFIED | | DWG TYPE | CUST DWG | PROJECT CODE | PHD | UNIT | mm | SIZE | A3 | PART No. | G88MPBXX0X2XXEU | | |
| ANGULAR | ±1° | | | | | | | SCALE | NA | SHEET | 5 OF 5 | DWG No. | G88MPBXX0X2XXEU | REV. | C |

Компания «Океан Электроники» предлагает заключение долгосрочных отношений при поставках импортных электронных компонентов на взаимовыгодных условиях!

Наши преимущества:

- Поставка оригинальных импортных электронных компонентов напрямую с производств Америки, Европы и Азии, а так же с крупнейших складов мира;
- Широкая линейка поставок активных и пассивных импортных электронных компонентов (более 30 млн. наименований);
- Поставка сложных, дефицитных, либо снятых с производства позиций;
- Оперативные сроки поставки под заказ (от 5 рабочих дней);
- Экспресс доставка в любую точку России;
- Помощь Конструкторского Отдела и консультации квалифицированных инженеров;
- Техническая поддержка проекта, помощь в подборе аналогов, поставка прототипов;
- Поставка электронных компонентов под контролем ВП;
- Система менеджмента качества сертифицирована по Международному стандарту ISO 9001;
- При необходимости вся продукция военного и аэрокосмического назначения проходит испытания и сертификацию в лаборатории (по согласованию с заказчиком);
- Поставка специализированных компонентов военного и аэрокосмического уровня качества (Xilinx, Altera, Analog Devices, Intersil, Interpoint, Microsemi, Actel, Aeroflex, Peregrine, VPT, Syfer, Eurofarad, Texas Instruments, MS Kennedy, Miteq, Cobham, E2V, MA-COM, Hittite, Mini-Circuits, General Dynamics и др.);

Компания «Океан Электроники» является официальным дистрибьютором и эксклюзивным представителем в России одного из крупнейших производителей разъемов военного и аэрокосмического назначения «JONHON», а так же официальным дистрибьютором и эксклюзивным представителем в России производителя высокотехнологичных и надежных решений для передачи СВЧ сигналов «FORSTAR».



JONHON

«JONHON» (основан в 1970 г.)

Разъемы специального, военного и аэрокосмического назначения:

(Применяются в военной, авиационной, аэрокосмической, морской, железнодорожной, горно- и нефтедобывающей отраслях промышленности)

«FORSTAR» (основан в 1998 г.)

ВЧ соединители, коаксиальные кабели, кабельные сборки и микроволновые компоненты:

(Применяются в телекоммуникациях гражданского и специального назначения, в средствах связи, РЛС, а так же военной, авиационной и аэрокосмической отраслях промышленности).



Телефон: 8 (812) 309-75-97 (многоканальный)

Факс: 8 (812) 320-03-32

Электронная почта: ocean@oceanchips.ru

Web: <http://oceanchips.ru/>

Адрес: 198099, г. Санкт-Петербург, ул. Калинина, д. 2, корп. 4, лит. А