

Output Filter for Motor Drives



- Reduction of drive output voltage dv/dt
- Restriction of overvoltages on motor cables
- Reduction of motor temperature
- Increase of motor service life
- Improvement of system reliability



Performance indicators

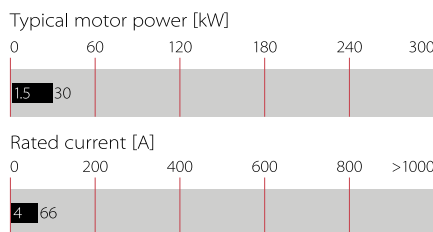

Technical specifications

Nominal operating voltage	3x 500/288 VAC
Motor frequency	0 to 400 Hz (4 to 24 A) 0 to 200 Hz (33 to 66 A)
Switching frequency	2 to 16 kHz
Rated currents	4 to 66 A @ 50°C
Motor cable length	80 m max. @ 16 kHz
Voltage drop	≤10 V @ 50 Hz
Typical dv/dt reduction	Factor 8 to 12
Typical reduction of overvoltages	≤1000 V
High potential test voltage	P → E 2500 VDC for 2 sec P → P 1100 VDC for 2 sec
Protection category	IP 20, if temperature auxiliary contact is connected with IP 20 faston connector
Overload capability	1.4x rated current for 1 minute, every 15 minutes
Temperature range (operation and storage)	-25°C to +70°C (25/070/21)
Flammability corresponding to	UL 94 V-2 or better
Design corresponding to	UL 1283, CSA 22.2 No. 8 1986, IEC/EN 60939
MTBF @ 50°C/400 V (Mil-HB-217F)	>100,000 hours

Approvals

ROHS

Features and benefits

- Efficient reduction of high output voltage dv/dt from IGBT motor drives (as per DIN VDE 0530)
- Restriction of overvoltages caused by line reflections on motor cables (as per DIN VDE 0530)
- Protection of motor coil insulation from premature aging and destruction
- Significant increase of service life of electric motors
- High reliability and production up time for mission critical applications
- Less interference propagation towards neighboring equipment or lines
- Output filter with low impedance, ideal for processes requiring exceptional precision and reproducibility of movements
- IP 20 housing and touch-safe terminal blocks contribute to overall equipment safety
- Temperature monitoring and internal fan cooling protect the filter from thermal overload

Typical applications

- Servo drives
- Close loop vector drives
- Motor drive applications with short to medium motor cable length
- Machinery comprising servo or torque motors
- Robots
- Pick and place machines
- Applications where sine wave filters are not applicable

Typical electrical schematic

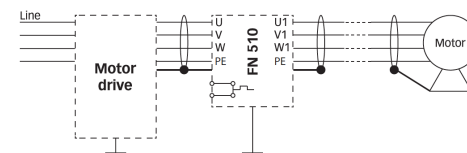

Filter selection table

Filter	Rated current @ 50°C [A]	Typical motor power rating* [kW]	Typical power loss** [W]	Input/Output connections	Weight [kg]
FN 510-4-29	4	1.5	90	-29	2.1
FN 510-8-29	8	3.7	90	-29	2.1
FN 510-12-29	12	5.5	90	-29	4
FN 510-16-29	16	7.5	90	-29	4.8
FN 510-24-33	24	11	100	-33	7.7
FN 510-33-33	33	15	110	-33	10
FN 510-50-34	50	22	130	-34	21
FN 510-66-34	66	30	130	-34	22

* General purpose four-pole (1500 r/min) AC induction motor rated 400 V/50 Hz.

**Power loss at 16 kHz switching frequency/80m motor cable length. Exact value depends upon the motor cable type and length, switching frequency and further stray parameters within the system.

Typical measurement results

dv/dt without FN 510

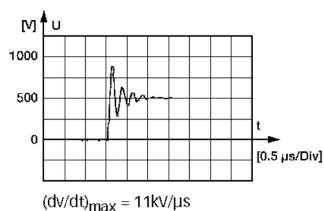

dv/dt with FN 510

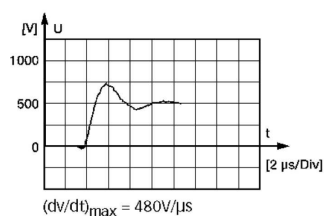

Overvoltages without FN 510

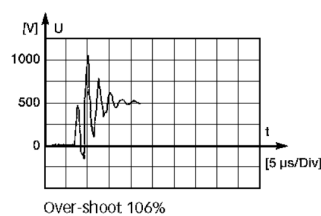

Overvoltages with FN 510

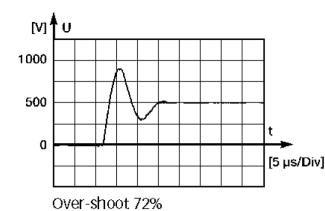

dv/dt reduction: maximum dv/dt at the motor terminals, measured with the motor drive operating at 14 kHz switching frequency, 5 m of shielded cable, motor with 100% load.

Overvoltage limitation: maximum overvoltages at the motor terminals, measured with the motor drive operating at 14 kHz switching frequency, 80 m of shielded cable, motor idling.

Typical application range at different operating conditions

The power loss in the filter depends mainly on the switching frequency (f_s) of the motor drive and the length of the motor cable. FN 510 have been designed for an ambient temperature of 50°C.

Other conditions can, however, occur in practice. In such cases, care must be taken to limit the maximum cable length and/or the switching frequency of the motor drive, depending on the real ambient temperature conditions.

FN 510 are designed for:

Tamb.	Max. f_s	Max. cable
50°C	10 kHz	80 m

Possible application, e.g.:

50°C	16 kHz	50 m
40°C	16 kHz	80 m

Temperature monitoring function

The temperature monitoring device opens a potential-free contact in the case of filter overtemperature (>120°C). The maximum switching capability is 5 A/240 V. The switch can be used, for example, in the input of a CNC controller or as the trip of a circuit breaker in order to interrupt the mains power supply.

Mechanical data

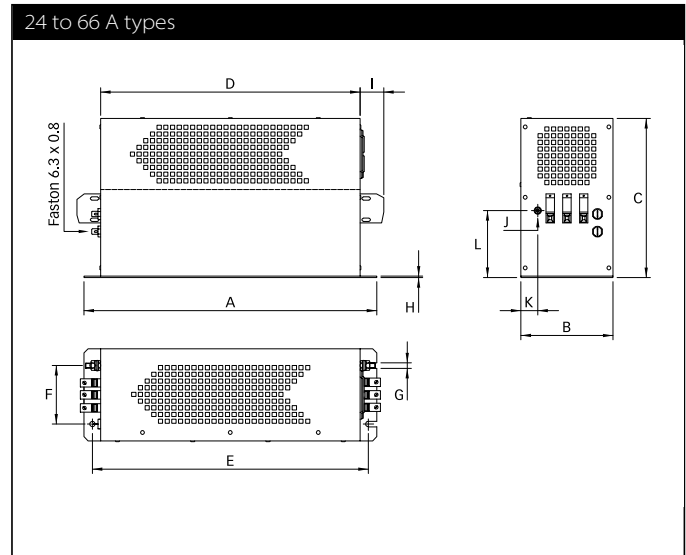
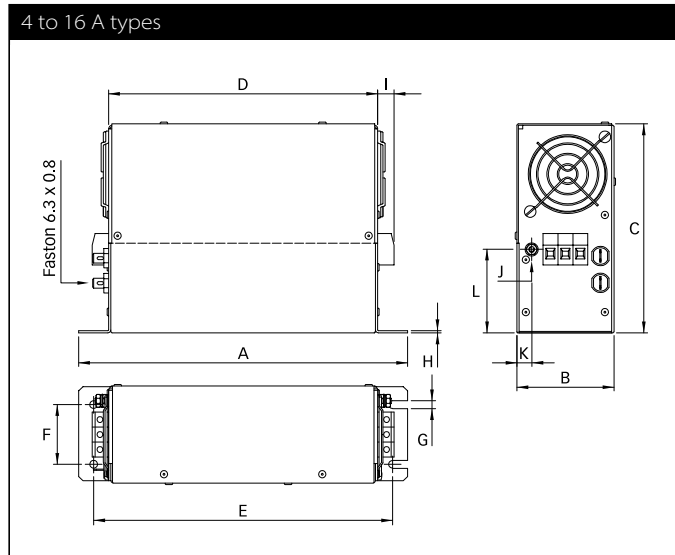

Dimensions

	4 A	8 A	12 A	16 A	24 A	33 A	50 A	66 A
A	220	220	260	260	350	350	470	470
B	65	65	85	85	110	110	140	140
C	140	140	160	160	190	190	235	235
D	180	180	220	220	310	310	420	420
E	200	200	240	240	330	330	440	440
F	40	40	60	60	70	70	100	100
G	5.3	5.3	6.5	6.5	6.5	6.5	8.3	8.3
H	1.5	1.5	1.5	1.5	2	2	5	5
I	10.9	10.9	10.9	10.9	25	25	39	39
J	M4	M4	M4	M4	M6	M6	M8	M8
K	10	10	12.5	12.5	20	20	20	20
L	56	56	65	65	80	80	125	125

All dimensions in mm; 1 inch = 25.4 mm
Tolerances according: ISO 2768-m / EN 22768-m

Filter input/output connector cross sections

	-29	-33	-34
Solid wire	6 mm ²	16 mm ²	35 mm ²
Flex wire	4 mm ²	10 mm ²	25 mm ²
AWG type wire	AWG 10	AWG 6	AWG 2
Recommended torque	0.6-0.8 Nm	1.5-1.8 Nm	4.0-4.5 Nm

Please visit www.schaffner.com to find more details on filter connectors.

For additional information please ask for FN 510 installation instructions and the Schaffner application note „Output Filters for Use with Frequency Inverters in Motor Drive Applications“.



Headquarters, global innovation and development

Switzerland

Schaffner Group

Nordstrasse 11
4542 Luterbach
T +41 32 681 66 26
info@schaffner.com
www.schaffner.com



Sales and application centers

China

Schaffner EMC Ltd. Shanghai

T20-3 C, No 565 Chuangye Road,
Pudong district
201201 Shanghai
T +86 21 3813 9500
cschina@schaffner.com
www.schaffner.com.cn

Finland

Schaffner Oy

Sauvonrinne 19 H
08500 Lohja
T +358 50 468 7284
finlandsales@schaffner.com

France

Schaffner EMC S.A.S.

16-20 Rue Louis Rameau
95875 Bezons
T +33 1 34 34 30 60
F +33 1 39 47 02 28
francesales@schaffner.com

Germany

Schaffner Deutschland GmbH

Schoemperlenstrasse 12B
76185 Karlsruhe
T +49 721 56910
F +49 721 569110
germanysales@schaffner.com

India

Schaffner India Pvt. Ltd

REGUS WORLD TRADE CENTRE
WTC, 22nd Floor Unit No 2238, Brigade
Gateway Campus, 26/1, Dr. Rajkumar Road
Malleswaram (W)
560055 Bangalore
T +91 80 67935355
indiasales@schaffner.com

Italy

Schaffner EMC S.r.l.

Via Ticino, 30
20900 Monza (MB)
T +39 039 21 41 070
italysales@schaffner.com

Japan

Schaffner EMC K.K.

1-32-12, Kamiyama, Setagaya-ku
7F Mitsui-seimei Sangenjaya Bldg.
154-0011 Tokyo
T +81 3 5712 3650
F +81 3 5712 3651
japansales@schaffner.com
www.schaffner.jp

Singapore

Schaffner EMC Pte Ltd.

#05-09, Kg Ubi Ind. Estate
408705 Singapore
T +65 6377 3283
F +65 6377 3281
singaporesales@schaffner.com

Spain

Schaffner EMC España

Calle Caléndula 93, Miniparc III, Edificio E
El Soto de Moraleja, Alcobendas
28109 Madrid
T +34 917 912 900
F +34 917 912 901
spainsales@schaffner.com

Sweden

Schaffner EMC AB

Tegeluddsvägen 76, 2tr
115 28 Stockholm
T +46 8 5050 2425
swedensales@schaffner.com
www.schaffner.com

Switzerland

Schaffner EMV AG

Nordstrasse 11
4542 Luterbach
T +41 32 681 66 26
switzerlandsales@schaffner.com

Taiwan R.O.C.

Schaffner EMV Ltd.

20 Floor-2, No 97, Section 1, XinTai 5th Road
22175 XiZhi District New Taipei City 22175
T +886 2 2697 5500
F +886 2 2697 5533
taiwansales@schaffner.com
www.schaffner.com.tw

Thailand

Schaffner EMC Co. Ltd.

Northern Region Industrial Estate
67 Moo 4 Tambon Ban Klang
Amphur Muangng P.O. Box 14
51000 Lamphun
T +66 53 58 11 04
F +66 53 58 10 19
thailandsales@schaffner.com

United Kingdom

Schaffner Ltd.

5 Ashville Way, Molly Millars Lane
Wokingham
RG41 2PL Berkshire
T +44 118 9770070
F +44 118 9792969
uksales@schaffner.com

USA

Schaffner EMC Inc.

52 Mayfield Avenue
08837 Edison, New Jersey
T +1 800 367 5566
T +1 732 225 9533
F +1 732 225 4789
usasales@schaffner.com
www.schaffnerusa.com

Schaffner North America

6722 Thirlane Road
24019 Roanoke, Virginia
T +1 276 228 7943
F +1 276 228 7953

Schaffner North America

823 Fairview Road
24382 Wytheville, Virginia
T +1 276 228 7943
F +1 276 228 7258

To find your local partner within Schaffner's global network: www.schaffner.com

© 2018 Schaffner Group

The content of this document has been carefully checked and understood. However, neither Schaffner nor its subsidiaries assume any liability whatsoever for any errors or inaccuracies of this document and the consequences thereof. Published specifications are subject to change without notice. Product suitability for any area of application must ultimately be determined by the customer. In all cases, products must never be operated outside their published specifications. Schaffner does not guarantee the availability of all published products. This disclaimer shall be governed by substantive Swiss law and resulting disputes shall be settled by the courts at the place of business of Schaffner Holding AG. Latest publications and a complete disclaimer can be downloaded from the Schaffner website. All trademarks recognized.

Компания «Океан Электроники» предлагает заключение долгосрочных отношений при поставках импортных электронных компонентов на взаимовыгодных условиях!

Наши преимущества:

- Поставка оригинальных импортных электронных компонентов напрямую с производств Америки, Европы и Азии, а так же с крупнейших складов мира;
- Широкая линейка поставок активных и пассивных импортных электронных компонентов (более 30 млн. наименований);
- Поставка сложных, дефицитных, либо снятых с производства позиций;
- Оперативные сроки поставки под заказ (от 5 рабочих дней);
- Экспресс доставка в любую точку России;
- Помощь Конструкторского Отдела и консультации квалифицированных инженеров;
- Техническая поддержка проекта, помощь в подборе аналогов, поставка прототипов;
- Поставка электронных компонентов под контролем ВП;
- Система менеджмента качества сертифицирована по Международному стандарту ISO 9001;
- При необходимости вся продукция военного и аэрокосмического назначения проходит испытания и сертификацию в лаборатории (по согласованию с заказчиком);
- Поставка специализированных компонентов военного и аэрокосмического уровня качества (Xilinx, Altera, Analog Devices, Intersil, Interpoint, Microsemi, Actel, Aeroflex, Peregrine, VPT, Syfer, Eurofarad, Texas Instruments, MS Kennedy, Miteq, Cobham, E2V, MA-COM, Hittite, Mini-Circuits, General Dynamics и др.);

Компания «Океан Электроники» является официальным дистрибьютором и эксклюзивным представителем в России одного из крупнейших производителей разъемов военного и аэрокосмического назначения «JONHON», а так же официальным дистрибьютором и эксклюзивным представителем в России производителя высокотехнологичных и надежных решений для передачи СВЧ сигналов «FORSTAR».



JONHON

«JONHON» (основан в 1970 г.)

Разъемы специального, военного и аэрокосмического назначения:

(Применяются в военной, авиационной, аэрокосмической, морской, железнодорожной, горно- и нефтедобывающей отраслях промышленности)

«FORSTAR» (основан в 1998 г.)

ВЧ соединители, коаксиальные кабели, кабельные сборки и микроволновые компоненты:

(Применяются в телекоммуникациях гражданского и специального назначения, в средствах связи, РЛС, а так же военной, авиационной и аэрокосмической отраслях промышленности).



Телефон: 8 (812) 309-75-97 (многоканальный)

Факс: 8 (812) 320-03-32

Электронная почта: ocean@oceanchips.ru

Web: <http://oceanchips.ru/>

Адрес: 198099, г. Санкт-Петербург, ул. Калинина, д. 2, корп. 4, лит. А