

cannon

SURE-SEAL Series



ITT

ENGINEERED FOR LIFE

We Connect

When it matters most

For more than a century, ITT Cannon has developed innovative interconnect solutions for the world's harshest environments. With facilities in the United States, Germany, Italy, Mexico, China and Japan, each with its unique strengths, we offer our customers interconnect solutions that are truly Engineered for Life.

In addition to this truly global footprint, we offer highly specialized, segmented industry expertise. We have a proven track record as an industry leader in harsh-environment applications. This has equipped us with the knowledge needed to continue to produce the most resilient, reliable connectors for our customers' most challenging conditions.

Interconnect solutions for the harshest environments.

The ITT Cannon difference

- Global capabilities & local support
- Proven application expertise
- A century of interconnect leadership
- A committed innovator & business partner

cannon

About ITT

ITT is a diversified leading manufacturer of highly engineered critical components and customized technology solutions for the energy, transportation and industrial markets. Building on its heritage of innovation, ITT partners with its customers to deliver enduring solutions to the key industries that underpin our modern way of life. Founded in 1920, ITT is headquartered in White Plains, N.Y., with employees in more than 35 countries and sales in a total of approximately 125 countries. For more information, visit www.itt.com.





Industrial / Instrumentation



Defense Vehicles



Medical



Heavy Equipment



Rail



Oil & Gas



Commercial & Military Aerospace

Our connector portfolio remains the most extensive in the industry, offering a reliable and cost effective range of interconnect solutions

Introduction to SURE-SEAL

This series was designed to meet the increased requirements for safety and reliability in the transportation field.

These field serviceable and sealed connectors satisfy all of the parameters defined by automotive / industrial standards including vibration, shock, temperature cycling, salt water spray, petroleum derivatives, industrial gases, and most important low millivolt drop and low contact resistance.

SURE-SEAL is as a reliable, watertight, low-cost solution for many manufacturers of heavy vehicles, trucks & buses, motorcycles and agricultural equipment. New applications are golf carts, outdoor lighting, portable construction signs and insulation monitors in electric buses.

SURE-SEAL with its simple design is an ideal solution anywhere a small low cost and fully sealed connector is needed.

Product portfolio

	Mini SURE-SEAL	SURE-SEAL
Number of contacts	2 - 4	2 - 10
Max. Current rating @ 40°C*	11 A	17 A
Wire range	0,4 - 0,75mm ² (AWG 20 - 18)	0,5 - 1,0mm ² (AWG 20 - 16) 0,75 - 1,5mm ² (AWG 18 - 14)
Wire insulation sealing range	1,4 - 1,8 mmØ	1,8 - 2,8 mmØ
Contact platings	Stamped contacts: tin, Machined contacts: silver	Stamped contacts: tin, Machined contacts: silver, gold
Max. Durability**	100 mating cycles	
IP class	IP67 (IEC 60529)	
* Depends on number and type of contacts used. ** Depends on plating and type of contacts used.		

➤ Simple design

Reducing total installation cost through one-piece molded rubber bodies. No other parts - other than contacts - are needed to assemble a complete sealed interconnect.

➤ Simple two set assembly

Save time and installation cost through a simple crimp and insertion process. No further steps are needed to receive a sealed connector system

➤ Chemical resistance

Sealing integrity is maintained with exposure to brake fluid, gasoline, diesel fuel, anti freeze, ozone and steam cleaning under normal operation conditions.

➤ Polarized against mis-mates

The main faces are designed with two stepped planes for a proper oriented contacts engagement. A raised indexing rib and matching raised indexing spline allows "blind" mating.

➤ Low cost stamped contacts

Without sacrificing quality, the cost of SURE-SEAL connectors is kept low with e.g. stamped contacts available on reels in continuous strips or as loose pieces.

➤ Environmentally sealed

No need for filler plugs and wire seals through rugged multiple moisture seals. SURE-SEAL is not just splash proof but truly submersible for short periods of time.

This document solely applies to SURE-SEAL products manufactured by ITT Cannon. ITT Cannon does not assume any responsibility or liability relating to the use, intermatability, compatibility, or interface of its SURE-SEAL products with any third party Sure-Seal products.

Table of contents

Introduction to SURE-SEAL.....	4
Industries & Applications.....	6
Mini SURE-SEAL	
Technical Data.....	7
Product Overview.....	8
SURE-SEAL	
Technical Data.....	10
Product Overview.....	11
Accessories	15
Tooling	
Crimp Tools.....	17
Insertion Tools.....	20
Extraction and Repair Tools.....	22
Part Number Index	24
Product Safety Information.....	25

Industries & Applications

INDUSTRIES



APPLICATIONS

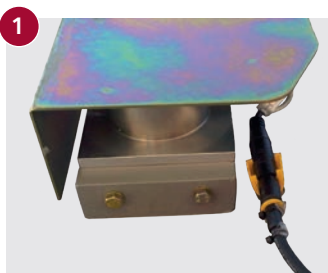

SURE-SEAL connectors assure reliable data of sensors for temperature and pressure

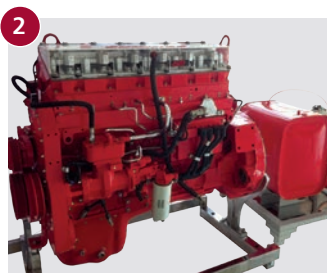

Off-Highway dump truck engines successfully driven with SURE-SEAL



Reliable breaking systems realized with SURE-SEAL connection



Ensuring a safe work at night and day with SURE-SEAL connectors on head and taillights

Mini SURE-SEAL

TECHNICAL DATA

Electrical Data

Operating Voltage	48 VDC*
Operating Current	see derating curve
Contact Resistance	10 Milliohms max.
Dielectric Withstanding Voltage	1200 VAC at sea level
Insulation Resistance	100 Megaohms min.

Wire Dimensions

Wire Range	0,4–0,75 mm ² (AWG 20-18)
Wire Insulation	
Sealing Range	1,4–1,8 mmØ

Mechanical Data

No. of contacts per connector	2 to 4
Polarization	Stepped plane positive polarization and visual polarization
Contact Retention	30 N minimum
Durability	50 mating cycles with stamped contacts, tin-plated 100 mating cycles with machined contacts, silver-plated

Environmental Data

Temperature Range	-40°C to 105°C (-40°F to 221°F)
Humidity Range	up to 95% r.h.
Sealing	IP67 (IEC 60529)
Salt Spray	100 h (DIN 50021, test SS)
Vibration	Sine wave 10-55 Hz, 1,5mm (IEC 60512-4, test 6d)
Physical Shock	Half sine 500 m/s ² , 11ms
Fluid Compatability	Fuel, engine oil, brake fluid, detergent fluid and others
Ozone Resistance	50 pphm, 48 h (DIN 53509-1)

Materials and Finishes

Plug and Receptacle	Nitril-Butadien rubber
Contacts, stamped	Copper alloy, tin plating
Contacts, machined	Copper alloy, hard silver plating



Current rating - Mini SURE-SEAL

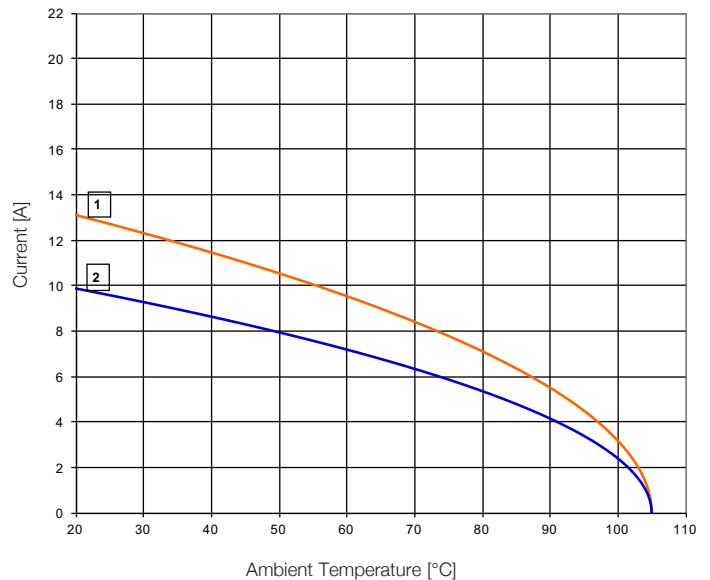

— 1: 2-way connector, wire size 0,75mm²
— 2: 2-way connector, wire size 0,4mm²

Connector fully equipped with stamped contacts

*Further information available upon request



Dimensions shown in mm
Specifications and dimensions subject to change

www.ittcannon.com

PRODUCT OVERVIEW

Contact Arrangements

● Pin ○ Socket

Plug

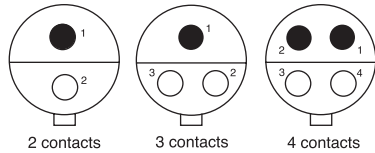

Receptacle

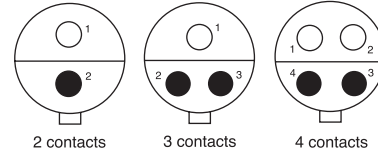

Part Numbers



Plug No. of contacts	Shell size	Part number
2	MSS 2 P	120-8552-100
3	MSS 3 P	120-8552-101
4	MSS 4 P	120-8552-102

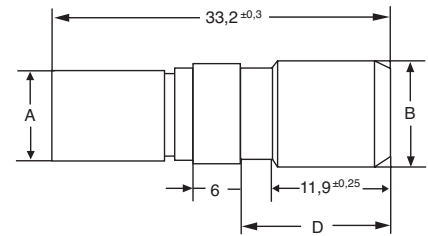

Receptacle No. of contacts	Shell size	Part number
2	MSS 2 R	120-8551-100
3	MSS 3 R	120-8551-101
4	MSS 4 R	120-8551-102

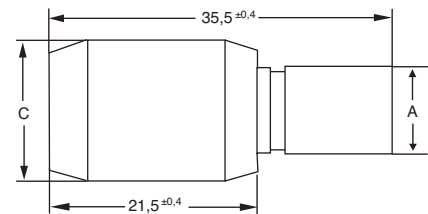

Measurements

Shell size	Ø A ± 0,15	Ø B - 0,2	Ø C - 0,3	D ± 0,3
MSS 2 P/R	8,2	9,6	13,4	16,3
MSS 3 P/R	8,8	10,4	14,4	13,4
MSS 4 P/R	8,8	11,0	15,0	13,4

Contacts, stamped, tinned With insulation support			Pins	Sockets	Wire hole fillers
Mini SURE-SEAL (MSS-100)	0,4–0,75 mm ²	Individual	330-8672-100	031-8703-100	225-1012-000
		on reels, 5000 pcs.	121348-0100	121347-0100	225-1012-000

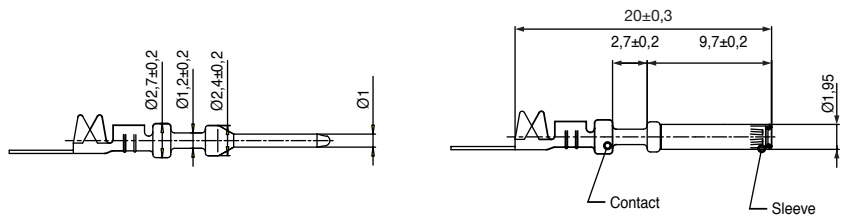

Pin	Socket	Wire hole filler *
-----	--------	--------------------

* Wire hole fillers are inserted into unused cavities instead of a contact in order to create a watertight sealing.

Contacts, machined, silver plated			Pins	Sockets	Wire hole fillers
Mini SURE-SEAL (MSS-100)	0,4–0,75 mm ²	Individual	330-8672-005	031-8703-052	225-1012-000

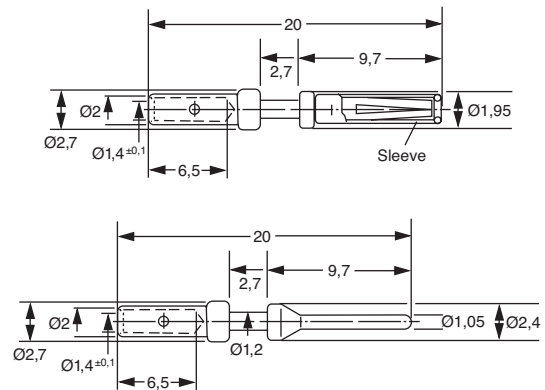

Pin	Socket	Wire hole filler *
-----	--------	--------------------

* Wire hole fillers are inserted into unused cavities instead of a contact in order to create a watertight sealing.

SURE-SEAL

TECHNICAL DATA

Electrical Data

Operating Voltage	48 VDC*
Operating Current	see derating curve
Contact Resistance	10 Milliohms max.
Dielectric Withstanding Voltage	1200 VAC at sea level
Insulation Resistance	100 Megaohms min.

Wire Dimensions

Wire Range	0,75–1,5 mm ² (AWG 18-14) 0,5-1,0 mm ² (AWG 20-16)
Wire insulation Sealing Range	1,8–2,8 mmØ

Mechanical Data

No. of contacts per connector	2 to 10
Polarization	Stepped plane positive polarization and visual polarization
Contact Retention	35 N minimum
Durability	50 mating cycles with stamped contacts, tin-plated 100 mating cycles with machined contacts, silver-plated

Environmental Data

Temperature Range	-40°C to 105°C (-40°F to 221°F)
Humidity Range	up to 95% r.h.
Sealing	IP67 (IEC 60529)
Salt spray	100 h (DIN 50021, test SS)
Vibration	Sine wave 10-55 Hz, 1,5mm (IEC 60512-4, test 6d)
Physical Shock	Half sine 500 m/s ² , 11ms
Fluid Compatibility	Fuel, engine oil, brake fluid, detergent fluid and others
Ozone Resistance	50 pphm, 48 h (DIN 53509-1)

Materials and Finishes

Plug and Receptacle	Nitril-Butadien rubber
Contacts, stamped	Copper alloy, tin plating
Contacts, machined	Copper alloy, hard silver plating



Current rating - SURE-SEAL

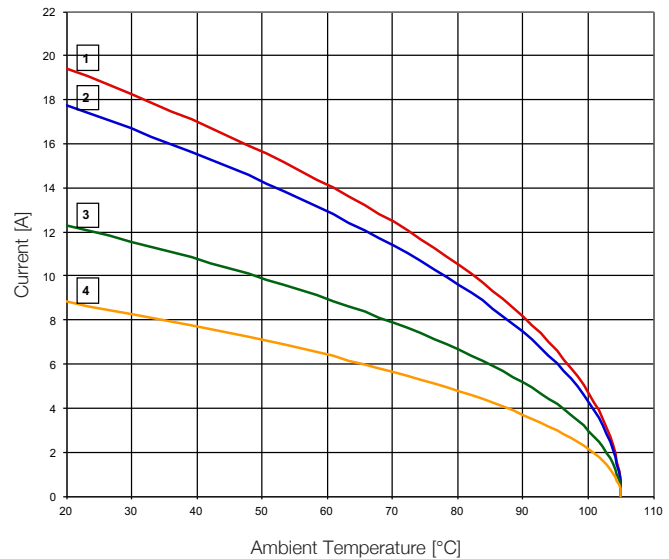

- 1: 2-way connector, wire size 1,5mm²
- 2: 7-way connector, wire size 1,5mm²
- 3: 2-way connector, wire size 0,5mm²
- 4: 7-way connector, wire size 0,5mm²

Connector fully equipped with stamped contacts



*Further information available upon request

Dimensions shown in mm
Specifications and dimensions subject to change

www.ittcannon.com



PRODUCT OVERVIEW

Plug

Contact Arrangements

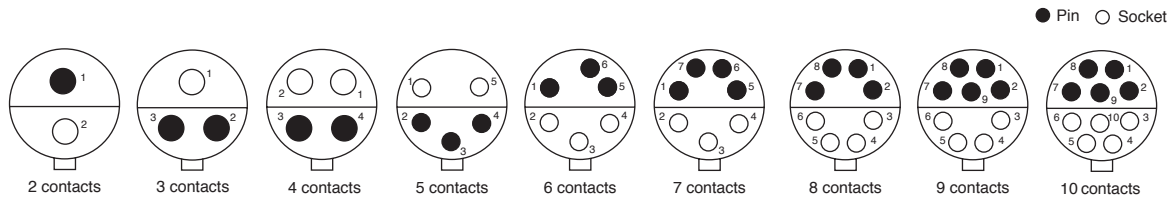

Part Numbers

2, 3 and 4 Contacts



No. of contacts	Shell size	Part number	Ø A - 0,3	Ø B - 0,3	Insulation Ø
2	SS2P	120-8552-000	13,9	10,9	1,8 - 2,8
3	SS3P	120-8552-001	15,2	12,3	1,8 - 2,8
4	SS4P	120-8552-002	15,2	12,3	1,8 - 2,8

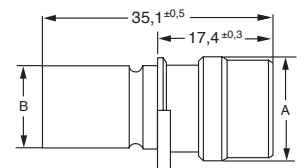

5, 6 and 7 Contacts



No. of contacts	Shell size	Part number	Ø A - 0,3	Ø B - 0,3	Insulation Ø
5	SS5P	120-8552-005	25,3	20,2	1,8 - 2,8
6	SS6P	120-8552-006	25,3	20,2	1,8 - 2,8
7	SS7P	120-8552-007	25,3	20,2	1,8 - 2,8

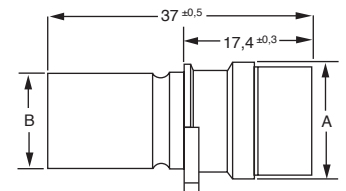

8 to 10 Contacts



No. of contacts	Shell size	Part number	Ø A ± 0,3	Ø B ± 0,3	Insulation Ø
8	SS8P	120-8552-308	28,5	23,5	1,8 - 2,8
9	SS9P	120-8552-309	28,5	23,5	1,8 - 2,8
10	SS10P	120-8552-310	28,5	23,5	1,8 - 2,8

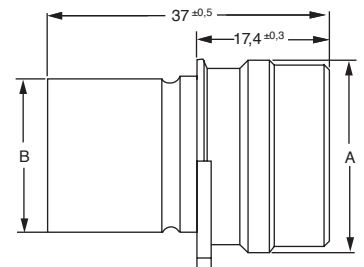

Plug with Flange Contact Arrangements

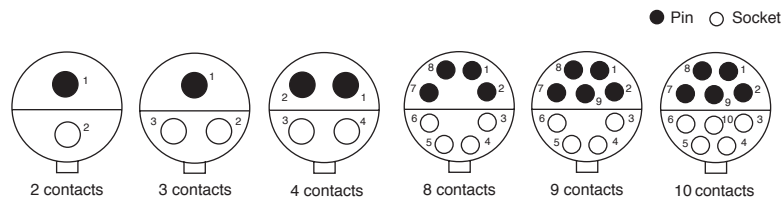

Part Numbers

2, 3 and 4 Contacts



No. of contacts	Shell size	Part number	Ø A - 0,3	Ø B - 0,3	Insulation Ø
2	SSF2P	120-8552-200	13,9	10,8	1,8 - 2,8
3	SSF3P	120-8552-201	15,2	12,3	1,8 - 2,8
4	SSF4P	120-8552-202	15,2	12,3	1,8 - 2,8

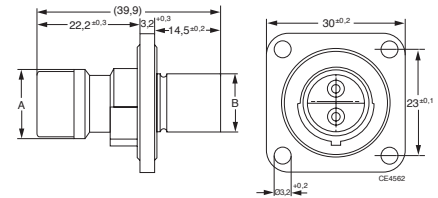

8, 9 and 10 Contacts



No. of contacts	Shell size	Part number	Ø A ± 0,3	Ø B ± 0,3	Insulation Ø
8	SSF8P	120-8552-305	28,5	23,5	1,8 - 2,8
9	SSF9P	120-8552-306	28,5	23,5	1,8 - 2,8
10	SSF10P	120-8552-307	28,5	23,5	1,8 - 2,8

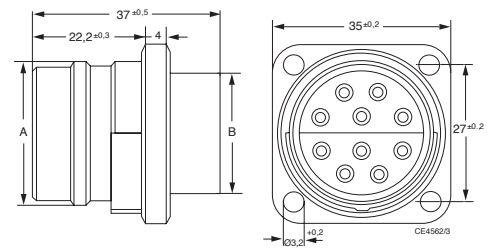

Receptacle Contact Arrangements

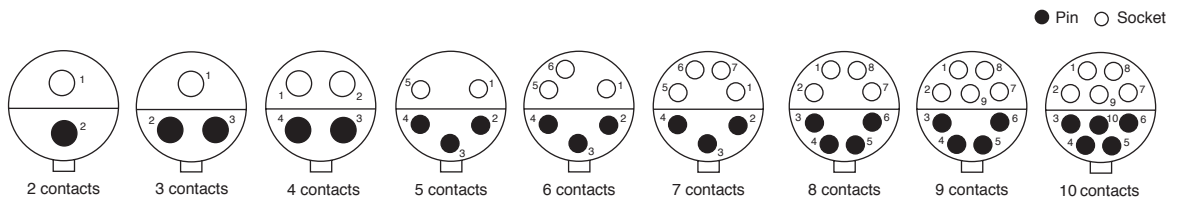

Part Numbers



No. of contacts	Shell size	Part number	Ø A - 0,5	Ø B - 0,3	Insulation Ø
2	SS2R	120-8551-000	18,0	10,9	1,8 - 2,8
3	SS3R	120-8551-001	18,9	12,3	1,8 - 2,8
4	SS4R	120-8551-002	18,9	12,3	1,8 - 2,8

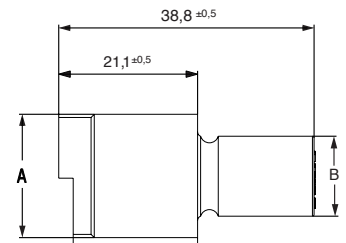

No. of contacts	Shell size	Part number	Ø A - 0,5	Ø B - 0,3	Insulation Ø
5	SS5R	120-8551-005	29,1	20,2	1,8 - 2,8
6	SS6R	120-8551-006	29,1	20,2	1,8 - 2,8
7	SS7R	120-8551-007	29,1	20,2	1,8 - 2,8

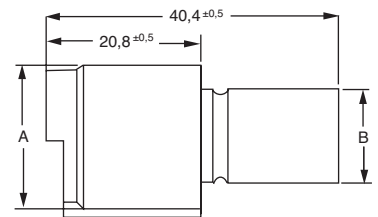

No. of contacts	Shell size	Part number	Ø A - 0,5	Ø B - 0,3	Insulation Ø
8	SS8R	120-8551-308	33,5	23,5	1,8 - 2,8
9	SS9R	120-8551-309	33,5	23,5	1,8 - 2,8
10	SS10R	120-8551-310	33,5	23,5	1,8 - 2,8

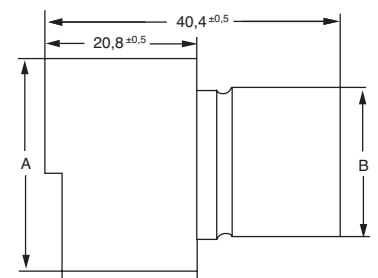



Contacts, stamped, tinned With insulation support		Pins	Sockets
SURE-SEAL (SS20) 0,5–1,0 mm ²	individual	330-8672-001	031-8703-001
	on reels, 5000 pcs.	121348-0020	121347-0020
SURE-SEAL (SS10) 0,75–1,5 mm ²	individual	330-8672-000	031-8703-000
	on reels, 5000 pcs.	121348-0010	121347-0010



Contacts, machined, silver plated With insulation support		Pins	Sockets
SURE-SEAL (SS20) 0,5–1,0 mm ²		330-8672-002	031-8703-050
SURE-SEAL (SS10) 0,75–1,5 mm ²		330-8672-003	031-8703-051

Wire size 12-14 and gold plating available upon request.

Mounting plate For SURE-SEAL with flange, steel, zinc finish

Mounting dimensions Front and rear panel mounting

Part no. 066-8516-000
(for 2 to 4 way connectors)

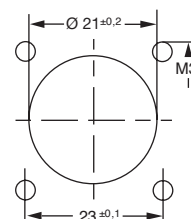
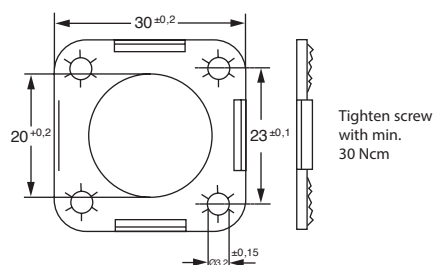

Part no. 066-8516-002
(for 8 to 10 way connectors)

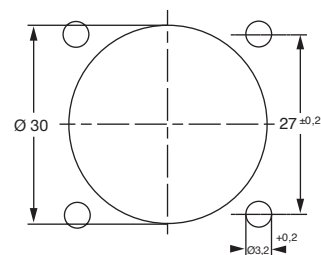
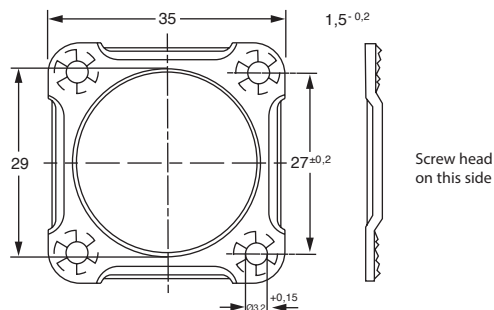

ACCESSORIES

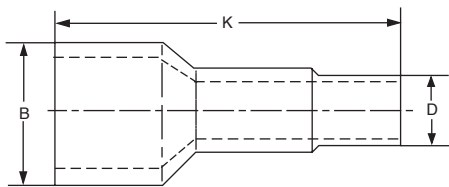

Boot

Seals wired cable jackets to connector housing. It also provides abrasion resistance.

For connector size	Part no.	B Ø max.	D Ø max.	Outer Cable Ø	K max.
2 contacts	317-1398-000	17,0	9,7	5,3 - 5,8	52,1
3/4 contacts	317-1397-000	15,8	9,7	5,6 - 6,1	52,5
4/3 contacts	317-1399-000	19,4	12,9	8,8 - 9,7	52,1
5/6/7 contacts	317-8657-000	27,6	12,5	7,2 - 8,4	62,0
8/9/10 cont.	317-8657-002	31,5	17,5	10,0 - 12,4	64,0

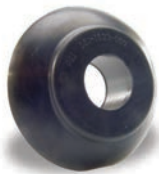
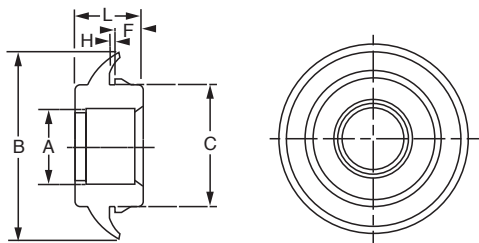

Grommet

Grommets enable panel mounting of either plugs or receptacle. It snaps into a hole of a panel so non-flanged plugs or receptacles can be mounted.

For connector size	Part no.	A Ø max.	B Ø max.	C Ø max.	F max.	H	L max.
2 contacts	351-1640-000	10,4	32,4	19,2	5,9	1,4	17,5
3/4 contacts	351-1641-000	11,9	32,4	19,2	5,9	1,4	17,5
5/6/7 contacts	351-1633-000	19,4	55,9	36,7	8,0	1,7	20,6
8/9/10 cont.	351-1634-000	22,6	55,9	36,7	8,0	1,7	20,6



Wire Fillers

Wire hole fillers are inserted into unused cavities instead of a contact in order to create a watertight sealing.

Mini SURE-SEAL Part number 225-1012-000	SURE-SEAL Part number 225-0093-000
---	--

Clip/Clamp

Clips/Clamps can be used as an extra lock to secure two connector halves. Due to its design it also offers the possibility for fixed mounting a mated pair by using a screw or a cable tie.

Clamp

Clamps, plug and receptacle in mated condition

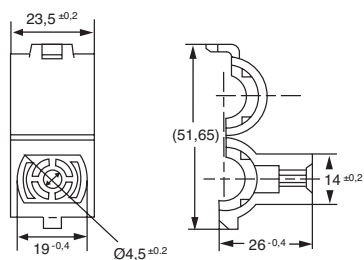

2, 3, 4 Contacts
Part no. 029-8514-001

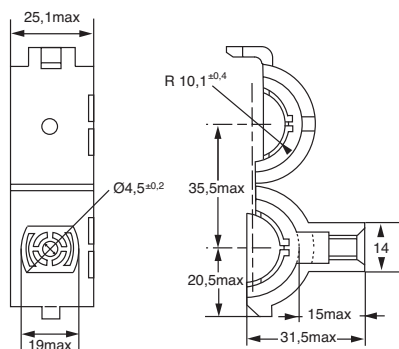

5, 6, 7 Contacts
Part no. 029-8514-000

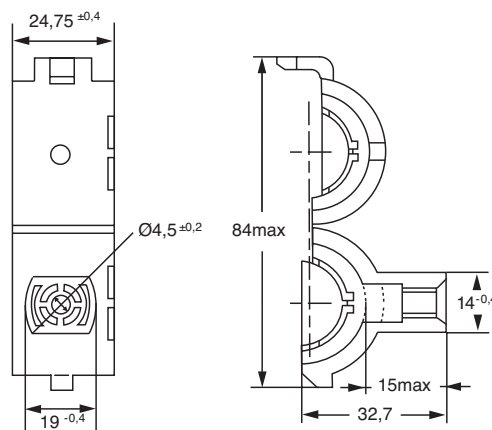

8, 9, 10 Contacts
Part no. 029-8514-004

Mounting Clip

Clamps, plug and receptacle in mated condition

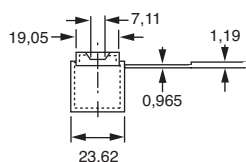

2, 3, 4 Contacts

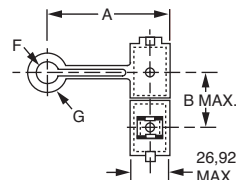
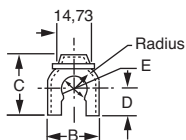

5-10 Contacts

Connector size	Colour of clip	Part no.	A max.	B	C	D	E Ø	F max.	G max.
2 contacts	Red	029-0263-000	-	22,6	25,4	10,7	10,7	-	-
3/4 contacts	Yellow	029-0262-000	-	23,6	26,7	11,4	12,2	-	-
5/6/7 contacts	Natural	026-0450-000	77,4	35,4	-	-	-	15,5	23,2
8/9/10 contacts	Black	026-0451-000	77,4	38,6	-	-	-	16,8	24,4

TOOLING

CRIMP TOOLS

Hand Crimp Tool CCT
for stamped contacts



Crimp tool	Part number	Contact size	Pin contact	Socket contact
CCT-MSS/SS-20N	121086-3331	SS20	330-8672-001	031-8703-001
CCT-MSS/SS-20N	121086-3331	MSS-100	330-8672-100	031-8703-100
CCT-SS-10N	121086-3332	SS10	330-8672-000	031-8703-000

Hand Crimp Tool M22520-1-01
for machined contacts



Crimp tool	Contacts	Contact size	Positioner	Wire size Pin and Socket mm ²	AWG
M22520-1-01 Part Number: 995-0001-585	330-8672-003 031-8703-051	SS10	120090-0114	0,75 - 1,5	
	330-8672-009 330-8672-002 031-8703-055	SS20	120090-0114	0,5 - 1,0	
	330-8672-008 031-8703-054	SS	120090-0114		12-14
	330-8672-005 031-8703-052	MSS-100	120090-0114	0,4 - 0,75	

Semi-Automatic Crimp Press TT for stamped contacts

The TT Crimp Press is available either in semi-automatic (for bench-top use) configuration or in full automatic (integrated into a cut and strip machine) configuration. Very compact and light, its spheroidal cast iron, one-piece structure offers the highest rigidity for a very stable crimping height value. A proprietary safety cover grants the operator a perfect view of the crimping zone while enjoying complete protection from any hazard. The semi-automatic configuration (for bench top use) always includes safety cover, reel arm, foot switch according to the international safety standard and CE regulation. Mini Applicators are available for all sizes of stamped and reeled contacts.

- ① Crimp Force Control
- ② Stripping Unit
- ③ Mini Applicator (to be ordered separately)

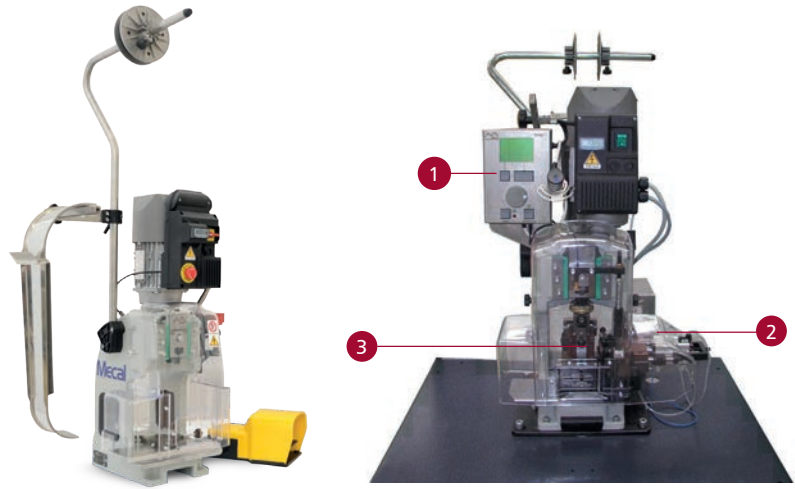

Mecal - TT

MECAL-TT-SC19-TT1000

Description	Part number	Crimp machine type
Mecal - TT	121586-5225	Basic Crimp Machine TT
Mecal-TT-SC19	121586-5221	Crimp Machine TT with stripping unit
MECAL-TT-SC19-TT1000	121586-5223	Crimp Machine TT with stripping unit and crimp force control

Mini Applicator for semi-automatic crimp machines

The Mini Applicator can be exchanged easy, quick and effortless. The compact construction as well as the clamping device allow using the Mini Applicator with other crimp machines.

Contacts
Contacts for the different connector series are available on reels. They can be terminated with the Mini Applicator on the Basic Crimp Press TT.



Quick change tool	Part number	Contact	Contact per reel	Termination range mm ²
WWZ-MECAL-SS-10-MES1068-JA	121586-5215	Sure Seal	5,000	0,75 - 1,5
WWZ-MECAL-SS-20-MES0476-JB	121586-5216	Sure Seal	5,000	0,5 - 1,0
WWZ-MECAL-MSS-MES0946-J	121586-5214	Mini Sure Seal	5,000	0,4 - 0,75

Pneumatic Crimp Tool WA27F-CE
for machined contacts

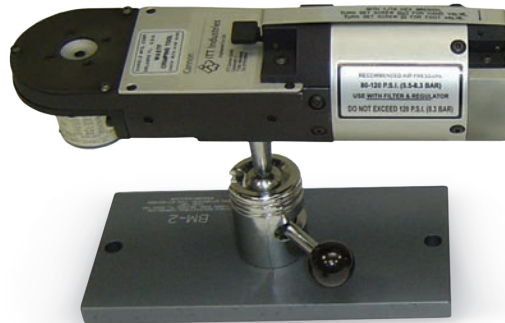

Part Numbers

Crimp tool	Contacts	Contact size	Positioner	Wire size Pin and Socket mm ²	AWG
WA27F-CE Part Number: 121586-5067	330-8672-003 031-8703-051	SS10	120090-0114	0,75 - 1,5	
	330-8672-009 330-8672-002 031-8703-055	SS20	120090-0114	0,5 - 1,0	
	330-8672-008 031-8703-054	SS	120090-0114		12-14
	330-8672-005 031-8703-052	MSS-100	120090-0114	0,4 - 0,75	

Bench Mount: BM-2 121586-5068
Foot Pedal: WA10 121586-5069

INSERTION TOOLS

Support Block for Series Production

Support block to fix the connectors and install contacts in small and medium series. This support block is used, according to individual requirements, with exchangeable inserts for plugs and receptacles.

The support block depicted on the left hand side of the image is visually representative of those used with 2 to 4 way SURE-SEAL and Mini SURE-SEAL connectors.

The support block depicted on the right hand side of the image is visually representative of those used for 5 to 10 way SURE-SEAL connectors.

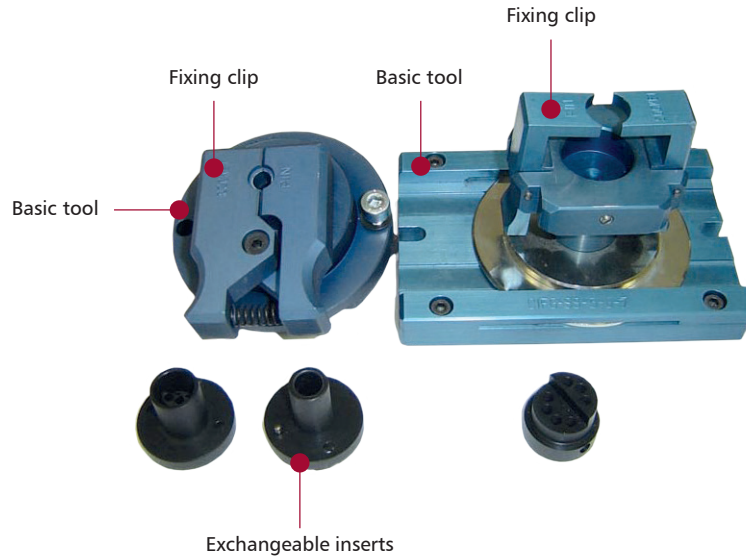

No. of contacts	Basic tool to use for					
	SURE-SEAL				Mini SURE-SEAL	
	Plug / Receptacle		Plug with flange		Plug / Receptacle	
	Description	Part no.	Description	Part no.	Description	Part no.
2	CIFG-SS-2	121086-3022	CIFG-SS-2	121086-3057	CIF-MSS-2	121086-3021
3	CIFG-SS-3	121086-3019	CIFG-SS-3	121086-3058	CIF-MSS-3	121086-3077
4	CIFG-SS-4	121086-3020	CIFG-SS-4	121086-3059	CIF-MSS-4	121086-3078
5/6/7	CIFG-SS-5-6-7	121586-0080	CIFG-SS-5-6-7	*		
8/9/10	CIFG-SS-8-9-10	121086-3056	CIFG-SS-8-9-10	*		

*available upon request

No. of contacts	Exchangeable inserts to use for				
	SURE-SEAL			Mini SURE-SEAL	
	Plug	Plug with flange	Receptacle	Plug	Receptacle
2	195-8508-000	195-8508-000	195-8508-001	195-8508-013	195-8508-014
3	195-8508-002	195-8508-002	195-8508-003	195-8508-015	195-8508-016
4	195-8508-004	195-8508-004	195-8508-005	195-8508-017	195-8508-018
5/6/7	195-8508-006	195-8508-006	195-8508-007	*	
8/9/10	195-8508-008	195-8508-008	195-8508-009	*	

*available upon request



Hand Insertion Tool CIT

Consists of a handle and an insertion tip.

Type of insulator	Description	Part no.	Outer insulation Ø
SS 2P + R to SS 10P + R SSF 8, 9, 10P	CITG-SS-1	121086-3025	1,8-2,8
SSF 2, 3, 4P	CIT-SSF-1	121086-3203	1,8-2,8
MSS 2, 3, 4P + R	CIT-MSS-1	121086-3023	1,4-1,8

Spare Parts for Hand Insertion Tool



Insertion Tip

Type of insulator	Description	Part no.	Outer insulation Ø
SS 2P + R to SS 10P + R SSF 8, 9, 10P	CITG-SS-1-TIP	121586-0076	1,8-2,8
SSF 2, 3, 4P	CIT-SSF-1-TIP	121086-3202	1,8-2,8
MSS 2, 3, 4P + R	CIT-MSS-1-TIP	121586-0074	1,4-1,8

Contact Holder Tip

Type of insulator	Part no.	Outer insulation Ø
SS 2P + R to SS 10P + R SSF 8, 9, 10P	317-8666-005	1,8-2,8
SSF 2, 3, 4P	317-8666-007	1,8-2,8
MSS 2, 3, 4P + R	317-8666-002	1,4-1,8

Handle

Spare part for hand insertion and extraction tools.
Part no.: 204-8501-002



Guiding Pins

Guiding pins have to be used for socket contacts. They allow a softer insertion and protection of the insulator body. Guiding pins are not necessary for Mini SURE-SEAL.

Part no: 317-8588-000



EXTRACTION AND REPAIR TOOLS

Hand Extraction Tool



Type of insulator	Pin contact		Socket contact	
	Description	Part no.	Description	Part no.
SS 2 - 10P + R SSF 2, 3, 4P SSF 8, 9, 10P	CET-SS-P	121586-0121	CET-SS-S	121586-0122
MSS 2, 3, 4P + R	CET-MSS-P	121586-0123	CET-MSS-S	121586-0124

Spare Tip



Type of insulator	Pin contact		Socket contact	
	Description	Part no.	Description	Part no.
SS 2 - 10P + R SSF 2, 3, 4P SSF 8, 9, 10P	CET-SS-P-TIP	121086-3207	CET-SS-S-TIP	121086-3189
MSS 2, 3, 4P + R	CET-MSS-P-TIP	121086-3191	CET-MSS-S-TIP	121086-3192

Auxiliary Tools CIEF and CIET
Auxiliary tools for repairs



Device for holding connectors during insertion and extraction of crimped contacts.

No. of contacts	Type of insulator	Description	Part no.
2,3,4	SS...P + R SSF...P	CIEF-SS-2-3-4	121086-3097
5,6,7	SS...P + R	CIEF-SS-5-6-7	121086-3098
8,9,10	SS...P + R SSF...P	CIEF-SS-8-9-10	121086-3179
2,3,4	MSS...P + R	CIEF-MSS-2-3-4	121086-3099

Guiding pins can be extracted by using a socket contact which is slightly tilted.

Kit for field repair work and prototype

Kit	No. of contacts	Type of insulator	Description	Part no.
1	2,3,4 2,3,4	SS...P + R SSF...P	CIET-SS-2-3-4-KIT-10	121086-3226
2	5,6,7	SS...P + R	CIET-SS-5-6-7-KIT-10	*
3*	8,9,10 8,9,10	SS...P + R SSF...P	CIET-SS-8-9-10-KIT-10	121086-3228
4	2,3,4 2,3,4	SS...P + R SSF...P	CIET-SS-2-3-4-KIT-20	121086-3229
5	5,6,7	SS...P + R	CIFG-SS-8-9-10	*
6*	8,9,10 8,9,10	SS...P + R SSF...P	CIET-SS-8-9-10-KIT-20	*
7	2,3,4	SS...P + R	CIET-MSS-2-3-4-KIT	121086-3232

* upon request



Contents

- 1 Operating instruction
- 1 CIEF Insertion and extraction holder
- 1 CIT Insertion tool
- 1 CET Extraction tool (socket contacts)
- 1 CET Extraction tool (pin contacts)
- 1 CCT Crimp tool

Lubricating fluid: Isopropyl alcohol
10 Guiding pins (not included for MSS)

SURE-SEAL

PART NUMBER INDEX

PART NUMBER	PAGE	PART NUMBER	PAGE	PART NUMBER	PAGE
026-0450-000	16	195-8508-000	20	121086-3023	21
026-0451-000	16	195-8508-001	20	121086-3025	21
029-0262-000	16	195-8508-002	20	121086-3056	20
029-0263-000	16	195-8508-003	20	121086-3057	20
029-8514-001	16	195-8508-004	20	121086-3058	20
029-8514-000	16	195-8508-005	20	121086-3059	20
029-8514-004	16	195-8508-006	20	121086-3077	20
031-8703-000	14, 17	195-8508-007	20	121086-3078	20
031-8703-001	14, 17	195-8508-008	20	121086-3097	23
031-8703-050	14	195-8508-009	20	121086-3098	23
031-8703-051	14, 17, 19	195-8508-013	20	121086-3099	23
031-8703-052	9, 17, 19	195-8508-014	20	121086-3179	23
031-8703-054	17, 19	195-8508-015	20	121086-3189	22
031-8703-055	17, 19	195-8508-016	20	121086-3191	22
031-8703-100	9, 17	195-8508-017	20	121086-3192	22
066-8516-000	14	195-8508-018	20	121086-3202	21
066-8516-002	14	204-8501-002	22	121086-3203	21
120-8551-000	13	225-0093-000	15	121086-3207	22
120-8551-001	13	225-1012-000	9, 15	121086-3226	23
120-8551-002	13	317-1398-000	15	121086-3228	23
120-8551-005	13	317-1397-000	15	121086-3229	23
120-8551-006	13	317-1399-000	15	121086-3232	23
120-8551-007	13	317-8588-000	22	121086-3331	17
120-8551-100	8	317-8657-000	15	121086-3332	17
120-8551-101	8	317-8657-002	15	121347-0010	14
120-8551-102	8	317-8666-002	21	121347-0020	14
120-8551-308	13	317-8666-005	21	121347-0100	9
120-8551-309	13	317-8666-007	21	121348-0010	14
120-8551-310	13	330-8672-000	14, 17	121348-0020	14
120-8552-000	11	330-8672-001	14, 17	121348-0100	9
120-8552-001	11	330-8672-002	14, 17, 19	121586-0074	21
120-8552-002	11	330-8672-003	14, 17, 19	121586-0076	21
120-8552-005	11	330-8672-005	9, 17, 19	121586-0080	20
120-8552-006	11	330-8672-008	17, 19	121586-0121	22
120-8552-007	11	330-8672-009	17, 19	121586-0122	22
120-8552-100	8	330-8672-100	9, 17	121586-0123	22
120-8552-101	8	351-1640-000	15	121586-0124	22
120-8552-102	8	351-1641-000	15	121586-5067	19
120-8552-200	12	351-1633-000	15	121586-5068	19
120-8552-201	12	351-1634-000	15	121586-5069	19
120-8552-202	12	995-0001-585	17	121586-5214	18
120-8552-305	12	120090-0114	17, 19	121586-5215	18
120-8552-306	12	121086-3019	20	121586-5216	18
120-8552-307	12	121086-3020	20	121586-5221	18
120-8552-308	11	121086-3021	20	121586-5223	18
120-8552-309	11	121086-3022	20	121586-5225	18
120-8552-310	11				



SURE-SEAL

PRODUCT SAFETY INFORMATION

THIS NOTE MUST BE READ IN CONJUNCTION WITH THE PRODUCT DATA SHEET/CATALOG. FAILURE TO OBSERVE THE ADVICE IN THIS INFORMATION SHEET AND THE OPERATING CONDITIONS SPECIFIED IN THE PRODUCT DATA SHEET/ CATALOG COULD RESULT IN HAZARDOUS SITUATIONS.

1. MATERIAL CONTENT AND PHYSICAL FORM

Electrical connectors do not usually contain hazardous materials. They contain conducting and non-conducting materials and can be divided into two groups.

- a) Printed circuit types and low cost audio types which employ all plastic insulators and casings.
- b) Rugged, Fire Barrier and High Reliability types with metal casings and either natural rubber, synthetic rubber, plastic or glass insulating materials. Contact materials vary with type of connector and also application and are usually manufactured from either: Copper, copper alloys, nickel, alumel, chromel or steel. In special applications, other alloys may be specified.

2. FIRE CHARACTERISTICS AND ELECTRIC SHOCK HAZARD

There is no fire hazard when the connector is correctly wired and used within the specified parameters. Incorrect wiring or assembly of the connector or careless use of metal tools or conductive fluids, or transit damage to any of the component parts may cause electric shock or burns. Live circuits must not be broken by separating mated connectors as this may cause arcing, ionization and burning. Heat dissipation is greater at maximum resistance in a circuit. Hot spots may occur when resistance is raised locally by damage, e.g. cracked or deformed contacts, broken strands of wire. Local overheating may also result from the use of the incorrect application tools or from poor quality soldering or slack screw terminals. Overheating may occur if the ratings in the product Data Sheet/Catalog are exceeded and can cause breakdown of insulation and hence electric shock. If heating is allowed to continue it intensifies by further increasing the local resistance through loss of temper of spring contacts, formation of oxide film on contacts and wires and leakage currents through carbonization of insulation and tracking paths. Fire can then result in the presence of combustible materials and this may release noxious fumes. Overheating may not be visually apparent. Burns may result from touching overheated components.

3. HANDLING

Care must be taken to avoid damage to any component parts of electrical connectors during installation and use. Although there are normally no sharp edges, care must be taken when handling certain components to avoid injury to fingers. Electrical connectors may be damaged in transit to the customers, and damage may result in creation of hazards. Products should therefore be examined prior to installation/use and rejected if found to be damaged.

4. DISPOSAL

Incineration of certain materials may release noxious or even toxic fumes.

5. APPLICATION

Connectors with exposed contacts should not be selected for use on the current supply side of an electrical circuit, because an electric shock could result from touching exposed contacts on an unmated connector. Voltages in excess of 30 V ac or 42.5 V dc are potentially hazardous and care should be taken to ensure that such voltages cannot be transmitted in any way to exposed metal parts of the connector body. The connector and wiring should be checked, before making live, to have no damage to metal parts or insulators, no solder blobs, loose strands, conducting lubricants, swarf, or any other undesired conducting particles. Circuit resistance and continuity check should be made to make certain that there are no high resistance joints or spurious conducting paths. Always use the correct application tools as specified in the Data Sheet/Catalog. Do not permit untrained personnel to wire, assemble or tamper with connectors. For operation voltage please see appropriate national regulations.

IMPORTANT GENERAL INFORMATION

(i) Air and creepage paths/Operating voltage. The admissible operating voltages depend on the individual applications and the valid national and other applicable safety regulations. For this reason the air and creepage path data are only reference values. Observe reduction of air and creepage paths due to PC board and/or harnessing.

(ii) Temperature

All information given are temperature limits. The operation temperature depends on the individual application.

(iii) Other important information

Cannon continuously endeavors to improve their products. Therefore, Cannon products may deviate from the description, technical data and shape as shown in this catalog and data sheets.

All data subject to change without notice.

This document solely applies to SURE-SEAL products manufactured by ITT Cannon. ITT Cannon does not assume any responsibility or liability relating to the use, intermatability, compatibility, or interface of its SURE-SEAL products with any third party Sure-Seal products.

cannon

Amazing things
happen when great
things connect



Connect with your ITT Cannon representative today
or visit us at www.ittcannon.com

Connect with the experts

ITT's Cannon brand is a world leader in the design and manufacture of highly engineered connector solutions for multiple end markets.



ENGINEERED FOR LIFE

North America

56 Technology Drive
Irvine, CA 92618, USA
Phone +1.800.854.3028

Europe

Corso Europa 41/43
20020 Lainate (MI) Italy
Phone: +39.02938721

Cannonstrasse 1
71384 Weinstadt, Germany
Phone: +49.7151.699.0

Asia

Tuopandun Industrial Area, Jinda Cheng,
Xiner Village, Shajing Town, Boan District,
Shenzhen City, Guangdong Province, China 518215
Phone: +86.755.2726.7888

Компания «Океан Электроники» предлагает заключение долгосрочных отношений при поставках импортных электронных компонентов на взаимовыгодных условиях!

Наши преимущества:

- Поставка оригинальных импортных электронных компонентов напрямую с производств Америки, Европы и Азии, а так же с крупнейших складов мира;
- Широкая линейка поставок активных и пассивных импортных электронных компонентов (более 30 млн. наименований);
- Поставка сложных, дефицитных, либо снятых с производства позиций;
- Оперативные сроки поставки под заказ (от 5 рабочих дней);
- Экспресс доставка в любую точку России;
- Помощь Конструкторского Отдела и консультации квалифицированных инженеров;
- Техническая поддержка проекта, помощь в подборе аналогов, поставка прототипов;
- Поставка электронных компонентов под контролем ВП;
- Система менеджмента качества сертифицирована по Международному стандарту ISO 9001;
- При необходимости вся продукция военного и аэрокосмического назначения проходит испытания и сертификацию в лаборатории (по согласованию с заказчиком);
- Поставка специализированных компонентов военного и аэрокосмического уровня качества (Xilinx, Altera, Analog Devices, Intersil, Interpoint, Microsemi, Actel, Aeroflex, Peregrine, VPT, Syfer, Eurofarad, Texas Instruments, MS Kennedy, Miteq, Cobham, E2V, MA-COM, Hittite, Mini-Circuits, General Dynamics и др.);

Компания «Океан Электроники» является официальным дистрибьютором и эксклюзивным представителем в России одного из крупнейших производителей разъемов военного и аэрокосмического назначения «JONHON», а так же официальным дистрибьютором и эксклюзивным представителем в России производителя высокотехнологичных и надежных решений для передачи СВЧ сигналов «FORSTAR».



JONHON

«JONHON» (основан в 1970 г.)

Разъемы специального, военного и аэрокосмического назначения:

(Применяются в военной, авиационной, аэрокосмической, морской, железнодорожной, горно- и нефтедобывающей отраслях промышленности)

«FORSTAR» (основан в 1998 г.)

ВЧ соединители, коаксиальные кабели,
кабельные сборки и микроволновые компоненты:

(Применяются в телекоммуникациях гражданского и специального назначения, в средствах связи, РЛС, а так же военной, авиационной и аэрокосмической отраслях промышленности).



Телефон: 8 (812) 309-75-97 (многоканальный)

Факс: 8 (812) 320-03-32

Электронная почта: ocean@oceanchips.ru

Web: <http://oceanchips.ru/>

Адрес: 198099, г. Санкт-Петербург, ул. Калинина, д. 2, корп. 4, лит. А