

Description

The TS512x devices are high-performance dual operational amplifiers with frequency and phase compensation built into the chip. The internal phase compensation allows stable operation in voltage follower configurations in spite of its high gain bandwidth product.

The circuit presents very stable electrical characteristics over the entire supply voltage range and it is particularly intended for professional and telecom applications (such as active filtering).

The TS512B is guaranteed with a higher minimum slew rate (1.072 V/ μ s) than TS512 and TS512A (0.8 V/ μ s).

Features

- Low input offset voltage: 500 μ V max. (A version)
- Low power consumption
- Short-circuit protection
- Wide power supply range:
 - Single supply: 3 to 30 V
 - Dual supplies: ± 1.5 to ± 15 V
- Low distortion, low noise
- High gain bandwidth product: 3 MHz
- High channel separation
- ESD protection 2 kV
- Macromodel included in this specification

Contents

1	Absolute maximum ratings and operating conditions	3
2	Schematic diagram	4
3	Electrical characteristics	5
4	Macromodel	11
4.1	Important notes concerning this macromodel	11
4.2	Macromodel code	11
5	Package information	14
6	Ordering information	16
7	Revision history	17

1 Absolute maximum ratings and operating conditions

Table 1. Absolute maximum ratings

Symbol	Parameter	Value	Unit
V_{CC}	Supply voltage	± 18	V
V_{in}	Input voltage	$\pm V_{CC}$	
V_{id}	Differential input voltage	$\pm(V_{CC} - 1)$	
R_{thja}	Thermal resistance junction-to-ambient ⁽¹⁾	125	°C/W
R_{thjc}	Thermal resistance junction-to-case ⁽¹⁾	40	°C/W
T_j	Junction temperature	+150	°C
T_{stg}	Storage temperature range	-65 to +150	°C
ESD	HBM: human body model ⁽²⁾	2	kV
	MM: machine model ⁽³⁾	200	V
	CDM: charged device model ⁽⁴⁾	1.5	kV

- Short-circuits can cause excessive heating and destructive dissipation. R_{th} are typical values.
- Human body model: a 100 pF capacitor is charged to the specified voltage, then discharged through a 1.5 k Ω resistor between two pins of the device. This is done for all couples of connected pin combinations while the other pins are floating.
- Machine model: a 200 pF capacitor is charged to the specified voltage, then discharged directly between two pins of the device with no external series resistor (internal resistor < 5 Ω). This is done for all couples of connected pin combinations while the other pins are floating.
- Charged device model: all pins and the package are charged together to the specified voltage and then discharged directly to ground through only one pin. This is done for all pins.

Table 2. Operating conditions

Symbol	Parameter	Value	Unit
V_{CC}	Supply voltage ⁽¹⁾	6 to 30V	V
V_{icm}	Common mode input voltage range	$V_{CC}-1.5$ to $V_{CC}+1.5$	V
T_{oper}	Operating free air temperature range	-40 to +125	°C

- Value with respect to V_{CC} - pin.

2 Schematic diagram

Figure 1. Schematic diagram (1/2 TS512)

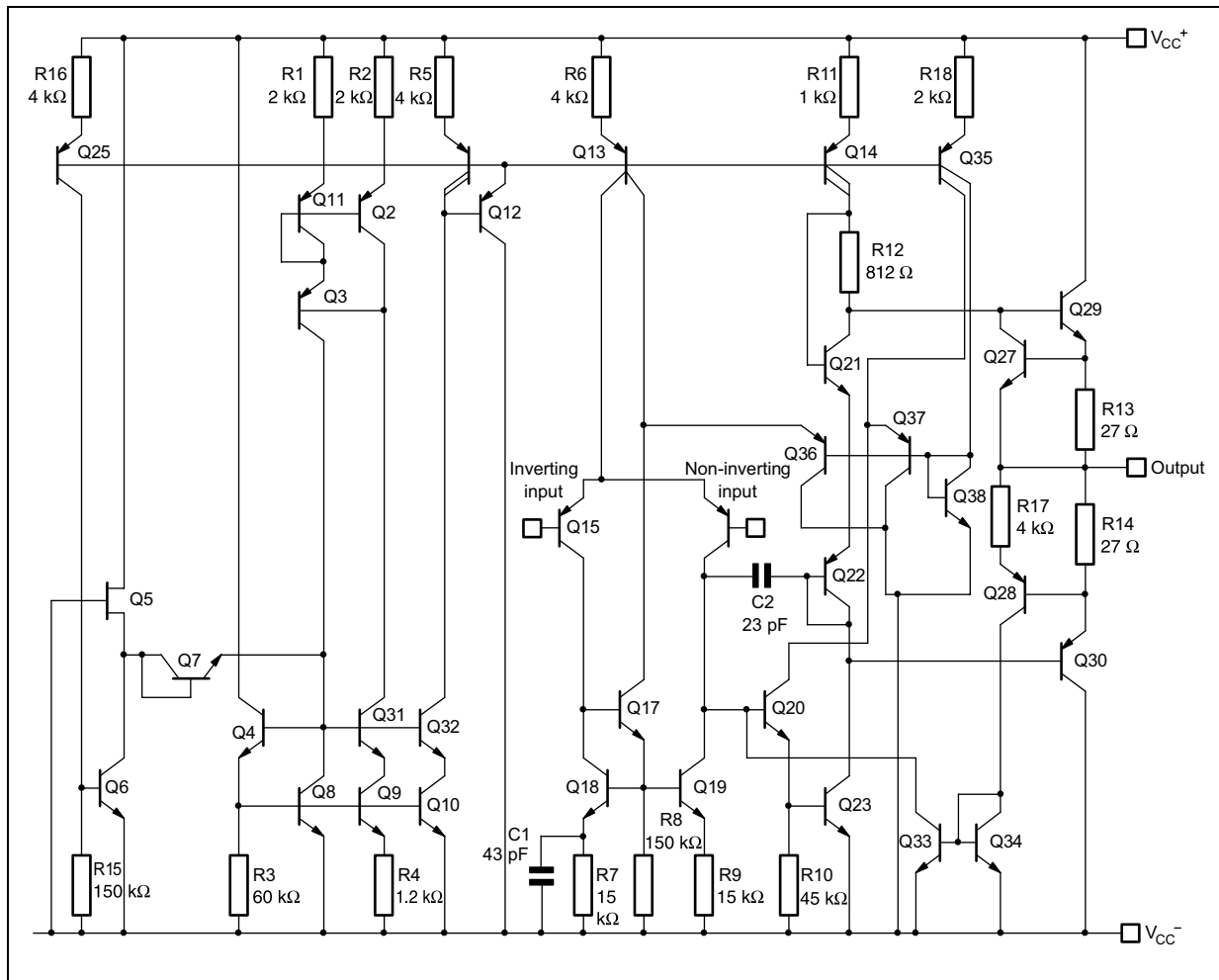

3 Electrical characteristics

Table 3. $V_{CC} = \pm 15\text{ V}$, $T_{amb} = 25\text{ }^\circ\text{C}$ (unless otherwise specified)

Symbol	Parameter	Min.	Typ.	Max.	Unit
I_{CC}	Supply current (per channel) $T_{min} \leq T_{amb} \leq T_{max}$		0.5	0.6 0.75	mA
I_{ib}	Input bias current $T_{min} \leq T_{amb} \leq T_{max}$		50	150 300	nA
R_{in}	Input resistance, $f = 1\text{ kHz}$		1		M Ω
V_{io}	Input offset voltage TS512 TS512A and TS512B $T_{min} \leq T_{amb} \leq T_{max}$ TS512 TS512A and TS512B		0.5	2.5 0.5 3.5 1.5	mV
ΔV_{io}	Input offset voltage drift $T_{min} \leq T_{amb} \leq T_{max}$		2		$\mu\text{V}/^\circ\text{C}$
I_{io}	Input offset current $T_{min} \leq T_{amb} \leq T_{max}$		5	20 40	nA
ΔI_{io}	Input offset current drift $T_{min} \leq T_{amb} \leq T_{max}$		0.08		nA/ $^\circ\text{C}$
I_{os}	Output short-circuit current		23		mA
A_{vd}	Large signal voltage gain $R_L = 2\text{ k}\Omega$, $V_{CC} = \pm 15\text{ V}$, $T_{min} \leq T_{amb} \leq T_{max}$ $V_{CC} = \pm 4\text{ V}$	90	100 95		dB
GBP	Gain bandwidth product, $f = 100\text{ kHz}$	1.8	3		MHz
e_n	Equivalent input noise voltage, $f = 1\text{ kHz}$ $R_s = 50\text{ }\Omega$ $R_s = 1\text{ k}\Omega$ $R_s = 10\text{ k}\Omega$		8 10 18		$\frac{\text{nV}}{\sqrt{\text{Hz}}}$
THD	Total harmonic distortion $A_v = 20\text{ dB}$, $R_L = 2\text{ k}\Omega$ $V_o = 2\text{ V}_{pp}$, $f = 1\text{ kHz}$		0.03		%
$\pm V_{opp}$	Output voltage swing $R_L = 2\text{ k}\Omega$, $V_{CC} = \pm 15\text{ V}$, $T_{min} \leq T_{amb} \leq T_{max}$ $V_{CC} = \pm 4\text{ V}$	± 13	± 3		V
V_{opp}	Large signal voltage swing $R_L = 10\text{ k}\Omega$, $f = 10\text{ kHz}$		28		V_{pp}
SR	Slew rate Unity gain, $R_L = 2\text{ k}\Omega$, TS512 and TS512A	0.8	1.5		V/ μs
	Slew rate Unity gain, $R_L = 2\text{ k}\Omega$, TS512B	1.072			
CMR	Common mode rejection ratio $\text{CMR} = 20 \log (\Delta V_{ic}/\Delta V_{io})$ ($V_{ic} = -10\text{ V}$ to 10 V , $V_{out} = V_{CC}/2$, $R_L > 1\text{ M}\Omega$)	90			dB

Table 3. $V_{CC} = \pm 15\text{ V}$, $T_{amb} = 25\text{ °C}$ (unless otherwise specified) (continued)

Symbol	Parameter	Min.	Typ.	Max.	Unit
SVR	Supply voltage rejection ratio $20 \log (\Delta V_{CC} / \Delta V_{io})$ ($V_{CC} = \pm 4\text{ V}$ to $\pm 15\text{ V}$, $V_{out} = V_{icm} = V_{CC}/2$)	90			dB
V_{o1}/V_{o2}	Channel separation, $f = 1\text{ kHz}$		120		dB

Figure 2. V_{io} distribution at $V_{CC} = \pm 15\text{ V}$ and $T = 25\text{ }^\circ\text{C}$



Figure 3. V_{io} distribution at $V_{CC} = \pm 15\text{ V}$ and $T = 125\text{ }^\circ\text{C}$

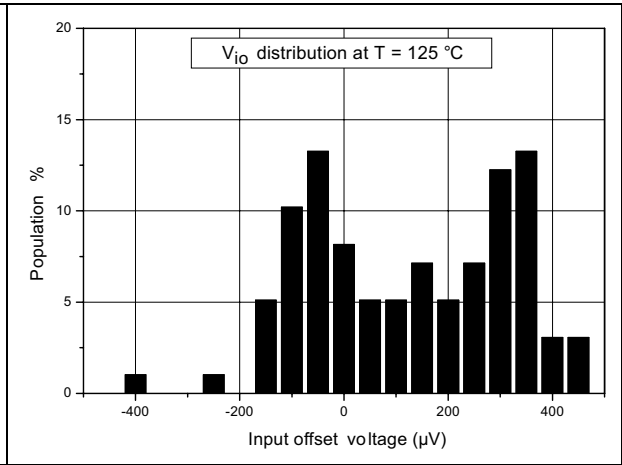

Figure 4. Input offset voltage vs. input common mode voltage at $V_{CC} = 10\text{ V}$

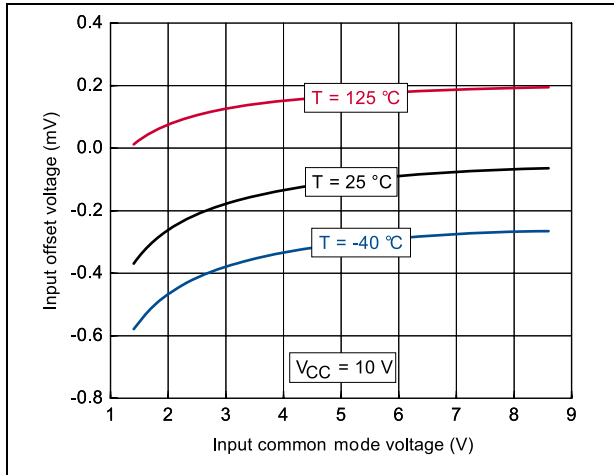

Figure 5. Input offset voltage vs. input common mode voltage at $V_{CC} = 30\text{ V}$

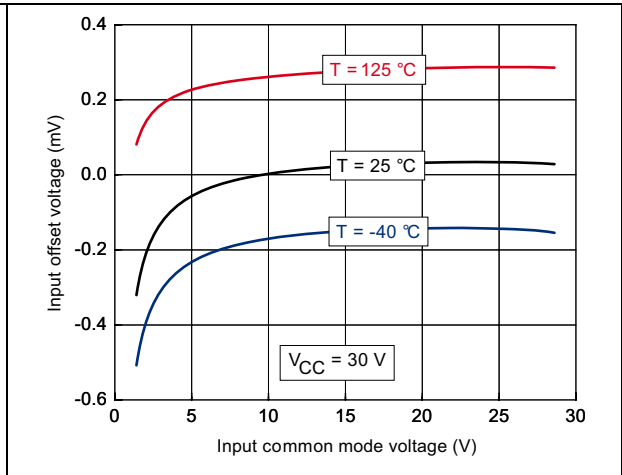

Figure 6. Supply current (per channel) vs. supply voltage at $V_{icm} = V_{CC}/2$

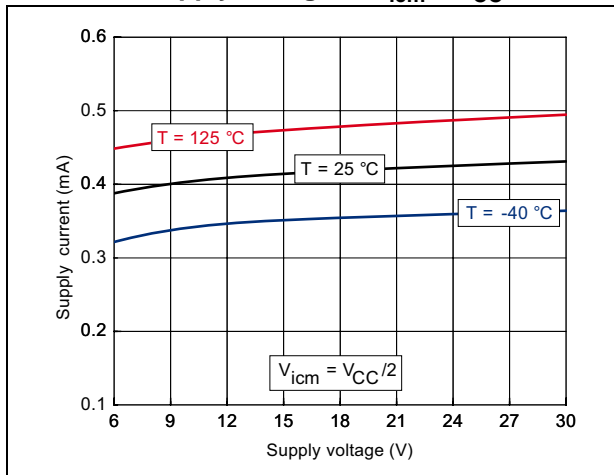

Figure 7. Supply current (per channel) vs. input common mode voltage at $V_{CC} = 6\text{ V}$

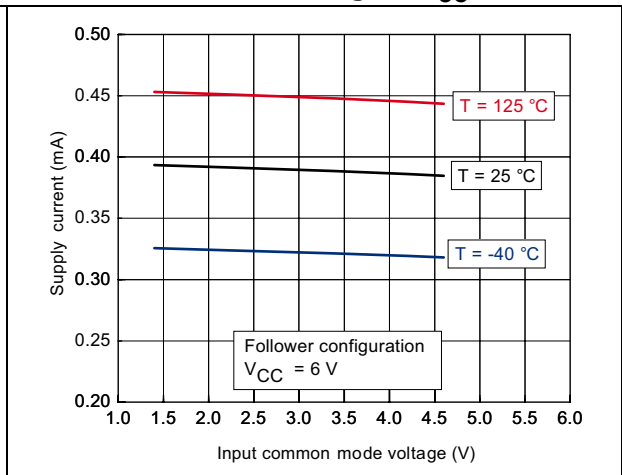

Figure 8. Supply current (per channel) vs. input common mode voltage at $V_{CC} = 10\text{ V}$



Figure 9. Supply current (per channel) vs. input common mode voltage at $V_{CC} = 30\text{ V}$

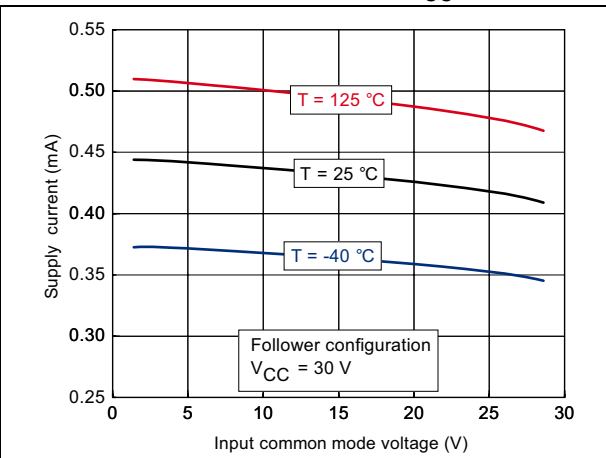

Figure 10. Output current vs. supply voltage at $V_{icm} = V_{CC}/2$



Figure 11. Output current vs. output voltage at $V_{CC} = 5\text{ V}$

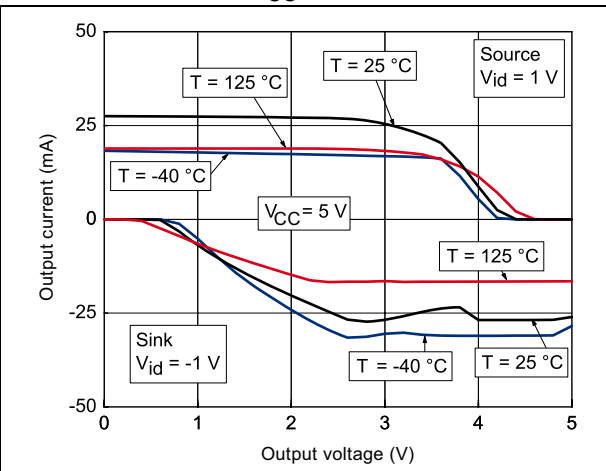

Figure 12. Output current vs. output voltage at $V_{CC} = 30\text{ V}$



Figure 13. Voltage gain and phase for different capacitive loads at $V_{CC} = 6\text{ V}$, $V_{icm} = 3\text{ V}$ and $T = 25\text{ }^\circ\text{C}$

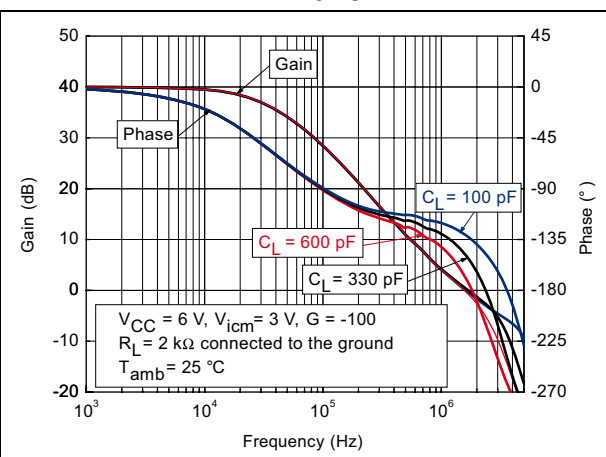

Figure 14. Voltage gain and phase for different capacitive loads at $V_{CC} = 10\text{ V}$, $V_{icm} = 5\text{ V}$ and $T = 25\text{ }^\circ\text{C}$



Figure 15. Voltage gain and phase for different capacitive loads at $V_{CC} = 30\text{ V}$, $V_{icm} = 15\text{ V}$ and $T = 25\text{ }^\circ\text{C}$



Figure 16. Frequency response for different capacitive loads at $V_{CC} = 6\text{ V}$, $V_{icm} = 3\text{ V}$ and $T = 25\text{ }^\circ\text{C}$



Figure 17. Frequency response for different capacitive loads at $V_{CC} = 10\text{ V}$, $V_{icm} = 5\text{ V}$ and $T = 25\text{ }^\circ\text{C}$



Figure 18. Frequency response for different capacitive loads at $V_{CC} = 30\text{ V}$, $V_{icm} = 15\text{ V}$ and $T = 25\text{ }^\circ\text{C}$



Figure 19. Phase margin vs. output current, at $V_{CC} = 6\text{ V}$, $V_{icm} = 3\text{ V}$ and $T = 25\text{ }^\circ\text{C}$



Figure 20. Phase margin vs. output current,
 at $V_{CC} = 10\text{ V}$, $V_{icm} = 5\text{ V}$
 and $T = 25\text{ }^{\circ}\text{C}$

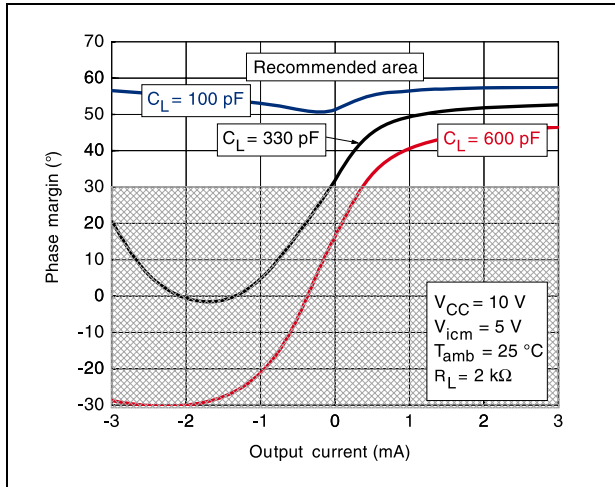
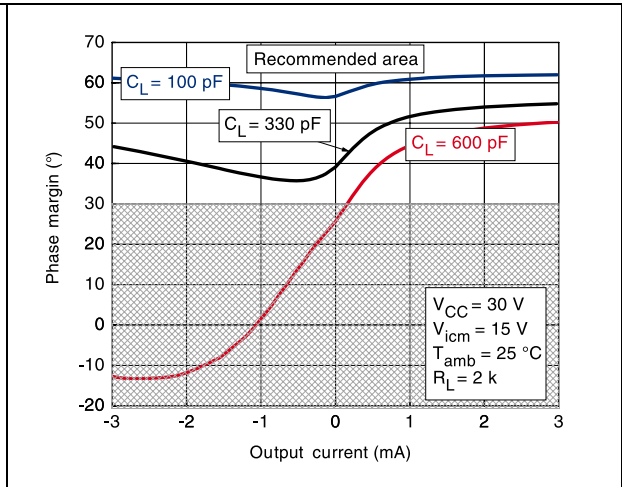

Figure 21. Phase margin vs. output current,
 at $V_{CC} = 30\text{ V}$, $V_{icm} = 15\text{ V}$
 and $T = 25\text{ }^{\circ}\text{C}$



4 Macromodel

4.1 Important notes concerning this macromodel

- All models are a trade-off between accuracy and complexity (i.e. simulation time).
- Macromodels are not a substitute to breadboarding; rather, they confirm the validity of a design approach and help to select surrounding component values.
- A macromodel emulates the **nominal** performance of a **typical** device within **specified operating conditions** (temperature, supply voltage, for example). Thus the macromodel is often not as exhaustive as the datasheet, its purpose is to illustrate the main parameters of the product.

Data derived from macromodels used outside of the specified conditions (V_{CC} , temperature, for example) or even worse, outside of the device operating conditions (V_{CC} , V_{icm} , for example), is not reliable in any way.

4.2 Macromodel code

```

** Standard Linear Ics Macromodels, 1993.
** CONNECTIONS :
* 1 INVERTING INPUT
* 2 NON-INVERTING INPUT
* 3 OUTPUT
* 4 POSITIVE POWER SUPPLY
* 5 NEGATIVE POWER SUPPLY

.SUBCKT TS512 1 3 2 4 5
*****
.MODEL MDTH D IS=1E-8 KF=6.565195E-17 CJO=10F
* INPUT STAGE
CIP 2 5 1.000000E-12
CIN 1 5 1.000000E-12
EIP 10 5 2 5 1
EIN 16 5 1 5 1
RIP 10 11 2.600000E+01
RIN 15 16 2.600000E+01
RIS 11 15 1.061852E+02
DIP 11 12 MDTH 400E-12
DIN 15 14 MDTH 400E-12
VOFP 12 13 DC 0
VOFN 13 14 DC 0
IPOL 13 5 1.000000E-05
CPS 11 15 12.47E-10
DINN 17 13 MDTH 400E-12
VIN 17 5 1.500000e+00
DINR 15 18 MDTH 400E-12

```

```
VIP 4 18 1.500000E+00
FCP 4 5 VOFP 3.400000E+01
FCN 5 4 VOFN 3.400000E+01
FIBP 2 5 VOFN 1.000000E-02
FIBN 5 1 VOFP 1.000000E-02
* AMPLIFYING STAGE
FIP 5 19 VOFP 9.000000E+02
FIN 5 19 VOFN 9.000000E+02
RG1 19 5 1.727221E+06
RG2 19 4 1.727221E+06
CC 19 5 6.000000E-09
DOPM 19 22 MDTH 400E-12
DONM 21 19 MDTH 400E-12
HOPM 22 28 VOUT 6.521739E+03
VIPM 28 4 1.500000E+02
HONM 21 27 VOUT 6.521739E+03
VINM 5 27 1.500000E+02
GCOMP 5 4 4 5 6.485084E-04
RPM1 5 80 1E+06
RPM2 4 80 1E+06
GAVPH 5 82 19 80 2.59E-03
RAVPHGH 82 4 771
RAVPHGB 82 5 771
RAVPHDH 82 83 1000
RAVPHDB 82 84 1000
CAVPHH 4 83 0.331E-09
CAVPHB 5 84 0.331E-09
EOUT 26 23 82 5 1
VOUT 23 5 0
ROUT 26 3 6.498455E+01
COUT 3 5 1.000000E-12
DOP 19 25 MDTH 400E-12
VOP 4 25 1.742230E+00
DON 24 19 MDTH 400E-12
VON 24 5 1.742230E+00
.ENDS
```

Table 4. $V_{CC} = \pm 15\text{ V}$, $T_{amb} = 25\text{ }^{\circ}\text{C}$ (unless otherwise specified)

Symbol	Conditions	Value	Unit
V_{io}		0	mV
A_{vd}	$R_L = 2\text{ k}\Omega$	100	V/mV
I_{CC}	No load, per channel	350	μA
V_{icm}		-13.4 to 14	V
V_{OH}	$R_L = 2\text{ k}\Omega$	+14	V
V_{OL}	$R_L = 2\text{ k}\Omega$	-14	V
I_{sink}	$V_o = 0\text{ V}$	27.5	mA
I_{source}	$V_o = 0\text{ V}$	27.5	mA
GBP	$R_L = 2\text{ k}\Omega$, $C_L = 100\text{ pF}$	2.5	MHz
SR	$R_L = 2\text{ k}\Omega$	1.4	V/ μs
$\varnothing m$	$R_L = 2\text{ k}\Omega$, $C_L = 100\text{ pF}$	55	Degrees

5 Package information

In order to meet environmental requirements, ST offers these devices in different grades of ECOPACK[®] packages, depending on their level of environmental compliance. ECOPACK specifications, grade definitions and product status are available at: www.st.com. ECOPACK is an ST trademark.

Figure 22. SO-8 package outline

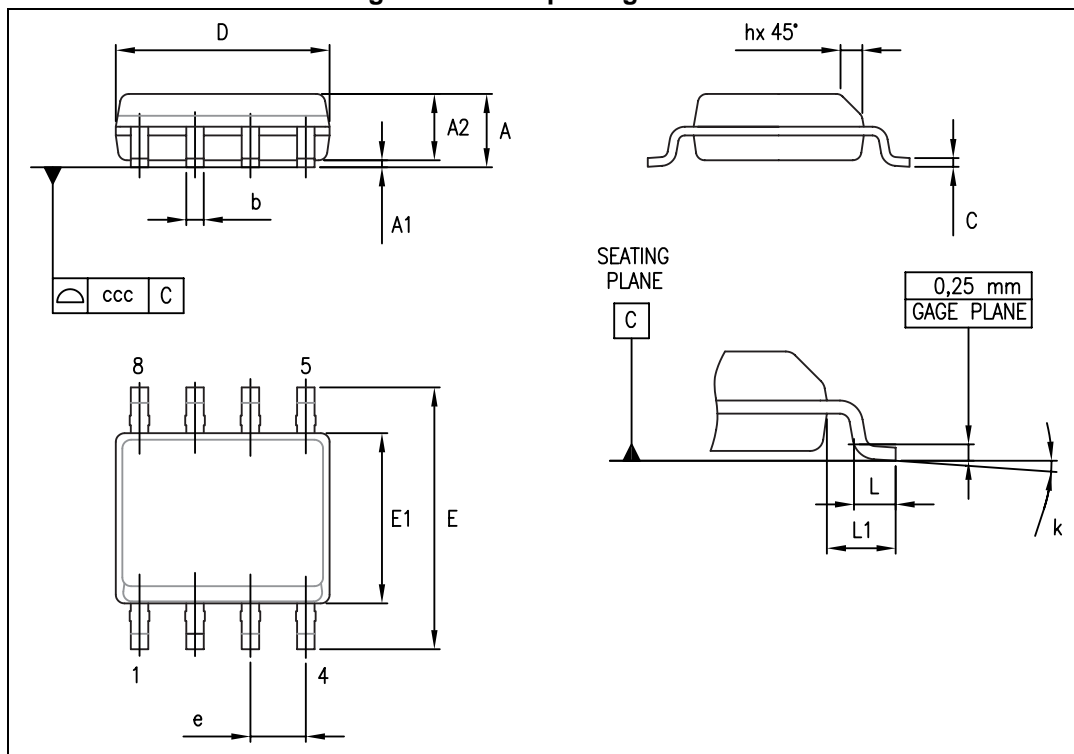

Table 5. SO-8 package mechanical data

Symbol	Dimensions					
	Millimeters			Inches		
	Min.	Typ.	Max.	Min.	Typ.	Max.
A			1.75			0.069
A1	0.10		0.25	0.004		0.010
A2	1.25			0.049		
b	0.28		0.48	0.011		0.019
c	0.17		0.23	0.007		0.010
D	4.80	4.90	5.00	0.189	0.193	0.197
E	5.80	6.00	6.20	0.228	0.236	0.244
E1	3.80	3.90	4.00	0.150	0.154	0.157
e		1.27			0.050	
h	0.25		0.50	0.010		0.020
L	0.40		1.27	0.016		0.050
L1		1.04			0.040	
k	0		8°	1°		8°
ccc			0.10			0.004

6 Ordering information

Table 6. Order codes

Order code	Temperature range	Package	Packaging	Marking
TS512IDT	-40 °C, + 125 °C	SO-8	Tape and reel	512I
TS512AIDT				512AI
TS512IYDT ⁽¹⁾		SO-8 (automotive grade)		512IY
TS512AIYDT ⁽¹⁾				512AIY
TS512BIYDT ⁽¹⁾				512BIY

1. Qualification and characterization according to AEC Q100 and Q003 or equivalent, advanced screening according to AEC Q001 and Q002 or equivalent.

7 Revision history

Table 7. Document revision history

Date	Revision	Changes
21-Nov-2001	1	Initial release.
23-Jun-2005	2	PPAP references inserted in the datasheet, see Table 6: Order codes.
05-May-2008	3	AC and DC performance characteristics curves added for $V_{CC}= 6V$, $V_{CC}= 10V$ and $V_{CC}= 30V$. Modified I_{CC} typ, added parameters over temperature range in electrical characteristics table. Corrected macromodel information.
04-Feb-2010	4	Updated document format. Added TS512A and related parameters. Modified footnote 1 under Table 2. Removed Figure 11. Modified Figure 12 and Figure 13. Removed TS512AIYD order code from Table 6.
12-Sep-2012	5	Updated CMR and SVR test conditions in Table 3. Removed TS512IYD order code from Table 6. Minor corrections throughout document.
20-Mar-2014	6	Removed DIP8 package option Removed shipping option in tubes from Table 6: Order codes Updated footnote 1 of Table 6: Order codes Minor textual updates
17-Apr-2017	7	Updated title, Features, Description and Table 6: Order codes to add the TS512B device and related parameters.
15-May-2017	8	Updated title, added reference to TS512B device in Table 3 V_{io} parameter description.

IMPORTANT NOTICE – PLEASE READ CAREFULLY

STMicroelectronics NV and its subsidiaries ("ST") reserve the right to make changes, corrections, enhancements, modifications, and improvements to ST products and/or to this document at any time without notice. Purchasers should obtain the latest relevant information on ST products before placing orders. ST products are sold pursuant to ST's terms and conditions of sale in place at the time of order acknowledgement.

Purchasers are solely responsible for the choice, selection, and use of ST products and ST assumes no liability for application assistance or the design of Purchasers' products.

No license, express or implied, to any intellectual property right is granted by ST herein.

Resale of ST products with provisions different from the information set forth herein shall void any warranty granted by ST for such product.

ST and the ST logo are trademarks of ST. All other product or service names are the property of their respective owners.

Information in this document supersedes and replaces information previously supplied in any prior versions of this document.

© 2017 STMicroelectronics – All rights reserved

Компания «Океан Электроники» предлагает заключение долгосрочных отношений при поставках импортных электронных компонентов на взаимовыгодных условиях!

Наши преимущества:

- Поставка оригинальных импортных электронных компонентов напрямую с производств Америки, Европы и Азии, а так же с крупнейших складов мира;
- Широкая линейка поставок активных и пассивных импортных электронных компонентов (более 30 млн. наименований);
- Поставка сложных, дефицитных, либо снятых с производства позиций;
- Оперативные сроки поставки под заказ (от 5 рабочих дней);
- Экспресс доставка в любую точку России;
- Помощь Конструкторского Отдела и консультации квалифицированных инженеров;
- Техническая поддержка проекта, помощь в подборе аналогов, поставка прототипов;
- Поставка электронных компонентов под контролем ВП;
- Система менеджмента качества сертифицирована по Международному стандарту ISO 9001;
- При необходимости вся продукция военного и аэрокосмического назначения проходит испытания и сертификацию в лаборатории (по согласованию с заказчиком);
- Поставка специализированных компонентов военного и аэрокосмического уровня качества (Xilinx, Altera, Analog Devices, Intersil, Interpoint, Microsemi, Actel, Aeroflex, Peregrine, VPT, Syfer, Eurofarad, Texas Instruments, MS Kennedy, Miteq, Cobham, E2V, MA-COM, Hittite, Mini-Circuits, General Dynamics и др.);

Компания «Океан Электроники» является официальным дистрибьютором и эксклюзивным представителем в России одного из крупнейших производителей разъемов военного и аэрокосмического назначения «JONHON», а так же официальным дистрибьютором и эксклюзивным представителем в России производителя высокотехнологичных и надежных решений для передачи СВЧ сигналов «FORSTAR».



JONHON

«JONHON» (основан в 1970 г.)

Разъемы специального, военного и аэрокосмического назначения:

(Применяются в военной, авиационной, аэрокосмической, морской, железнодорожной, горно- и нефтедобывающей отраслях промышленности)

«FORSTAR» (основан в 1998 г.)

ВЧ соединители, коаксиальные кабели, кабельные сборки и микроволновые компоненты:

(Применяются в телекоммуникациях гражданского и специального назначения, в средствах связи, РЛС, а так же военной, авиационной и аэрокосмической отраслях промышленности).



Телефон: 8 (812) 309-75-97 (многоканальный)

Факс: 8 (812) 320-03-32

Электронная почта: ocean@oceanchips.ru

Web: <http://oceanchips.ru/>

Адрес: 198099, г. Санкт-Петербург, ул. Калинина, д. 2, корп. 4, лит. А