

### FEATURES

**Synchronous Operation**  
**Full-Scale Frequency Set by External System Clock**  
**8-Lead SOT-23 and 8-Lead microSOIC Packages**  
**3 V or 5 V Operation**  
**Low Power: 3 mW (Typ)**  
**Nominal Input Range: 0 to  $V_{REF}$**   
**True -150 mV Capability Without Charge Pump**  
 **$V_{REF}$  Range: 2.5 V to VDD**  
**Internal 2.5 V Reference**  
**1 MHz Max Input Frequency**  
**Selectable High Impedance Buffered Input**  
**Minimal External Components Required**

### APPLICATIONS

**Isolation of High Common-Mode Voltages**  
**Low-Cost Analog-to-Digital Conversion**  
**Battery Monitoring**  
**Automotive Sensing**

### GENERAL DESCRIPTION

The AD7740 is a low-cost, ultrasmall synchronous Voltage-to-Frequency Converter (VFC). It works from a single 3.0 V to 3.6 V or 4.75 V to 5.25 V supply consuming 0.9 mA. The AD7740 is available in an 8-lead SOT-23 and also in an 8-lead microSOIC package. Small package, low cost and ease of use were major design goals for this product. The part contains an on-chip 2.5 V bandgap reference but the user may overdrive this using an external reference. This external reference range includes VDD.

The full-scale output frequency is synchronous with the clock signal on the CLKIN pin. This clock can be generated with the addition of an external crystal (or resonator) or supplied from a CMOS-compatible clock source. The part has a maximum input frequency of 1 MHz.

For an analog input signal that goes from 0 V to  $V_{REF}$ , the output frequency goes from 10% to 90% of  $f_{CLKIN}$ . In buffered mode, the part provides a very high input impedance and accepts a range of 0.1 V to VDD - 0.2 V on the VIN pin. There is also an unbuffered mode of operation that allows VIN to go from -0.15 V to VDD + 0.15 V. The modes are interchangeable using the BUF pin.

The AD7740 (Y Grade) is guaranteed over the automotive temperature range of -40°C to +105°C. The AD7740 (K Grade) is guaranteed from 0°C to 85°C.

\*Protected under U.S. Patent # 6,147,528.

### REV. A

Information furnished by Analog Devices is believed to be accurate and reliable. However, no responsibility is assumed by Analog Devices for its use, nor for any infringements of patents or other rights of third parties which may result from its use. No license is granted by implication or otherwise under any patent or patent rights of Analog Devices.

### FUNCTIONAL BLOCK DIAGRAM

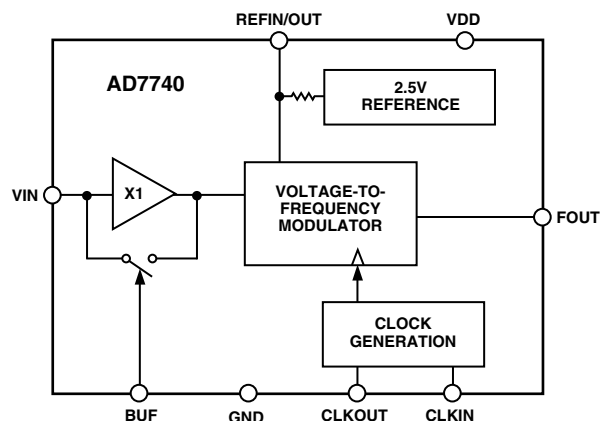

### PRODUCT HIGHLIGHTS

1. The AD7740 is a single channel, single-ended VFC. It is available in 8-lead SOT-23 and 8-lead microSOIC packages, and is intended for low-cost applications. The AD7740 offers considerable space saving over alternative solutions.
2. The AD7740 operates from a single 3.0 V to 3.6 V or 4.75 V to 5.25 V supply and consumes typically 0.9 mA when the input is unbuffered. It also contains an automatic power-down function.
3. The AD7740 does not require external resistors and capacitors to set the output frequency. The maximum output frequency is set by a crystal or a clock. No trimming or calibration is required.
4. The analog input can be taken to 150 mV below GND for true bipolar operation.
5. The specified voltage reference range on REFIN is from 2.5 V to the supply voltage, VDD.

# AD7740 SPECIFICATIONS (VDD = 3.0 V to 3.6 V, 4.75 V to 5.25 V, GND = 0 V, REFIN = 2.5 V; CLKIN = 1 MHz; All specifications T<sub>MIN</sub> to T<sub>MAX</sub> unless otherwise noted.)

Parameter <sup>2</sup>	K, Y Versions <sup>1</sup>			Unit	Test Conditions/Comments
	Min	Typ	Max		
<b>DC PERFORMANCE</b>					
Integral Nonlinearity					
CLKIN = 32 kHz <sup>3</sup>			±0.012	% of Span <sup>4</sup>	Unbuffered Mode, External Clock at CLKIN
CLKIN = 1 MHz			±0.012	% of Span	Unbuffered Mode, Crystal at CLKIN
CLKIN = 32 kHz <sup>3</sup>			±0.018	% of Span	Buffered Mode, External Clock at CLKIN
CLKIN = 1 MHz			±0.018	% of Span	Buffered Mode, Crystal at CLKIN
Offset Error		±7	±35	mV	Unbuffered Mode, VIN = 0 V
		±7	±35	mV	Buffered Mode, VIN = 0.1 V
Gain Error		±0.1	±0.7	% of Span	
Offset Error Drift <sup>3</sup>		±20		µV/°C	
Gain Error Drift <sup>3</sup>		±4		ppm of Span/°C	
Power Supply Rejection Ratio <sup>3</sup>		-55		dB	ΔVDD = ±5% (5 V)
		-65		dB	ΔVDD = ±10% (3.3 V)
<b>ANALOG INPUT, VIN</b>					
Nominal Input Span	0.1	0 – V <sub>REF</sub>	VDD – 0.2	V	±150 mV Overrange Available
				V	Buffered Mode
Input Current		8	10	µA	Unbuffered Mode, VIN = 5.4 V, REFIN = 5.25 V
		5	100	nA	Buffered Mode, VIN = 0.1 V, REFIN = 2.5 V
<b>REFERENCE VOLTAGE</b>					
REFIN <sup>5</sup>					
Nominal Input Voltage		2.5	VDD	V	
REFOUT					
Output Voltage	2.3	2.5	2.7	V	
Output Impedance <sup>3</sup>		1		kΩ	See Pin Function Description
Reference Drift <sup>3</sup>		±50		ppm/°C	
Line Rejection <sup>3</sup>		-75		dB	ΔVDD = ±5% (5 V)
Line Rejection <sup>3</sup>		-60		dB	ΔVDD = ±10% (3.3 V)
Reference Noise (0.1 Hz to 10 Hz) <sup>3</sup>		100		µV p-p	
<b>FOUT OUTPUT</b>					
Nominal Frequency Span	0.1 f <sub>CLKIN</sub>	to 0.9 f <sub>CLKIN</sub>		Hz	VIN = 0 V to V <sub>REF</sub> . See Figure 2
<b>LOGIC INPUTS (CLKIN, BUF)<sup>3</sup></b>					
CLKIN					
Input Frequency	32		1000	kHz	For Specified Performance
Input High Voltage, V <sub>IH</sub>	3.5			V	VDD = 5 V ± 5%
Input High Voltage, V <sub>IH</sub>	2.5			V	VDD = 3.3 V ± 10%
Input Low Voltage, V <sub>IL</sub>			0.8	V	VDD = 5 V ± 5%
Input Low Voltage, V <sub>IL</sub>			0.4	V	VDD = 3.3 V ± 10%
Input Current			±2	µA	VIN = 0 V to V <sub>DD</sub>
Pin Capacitance		3	10	pF	
BUF					
Input High Voltage, V <sub>IH</sub>	2.4			V	VDD = 5 V ± 5%
Input High Voltage, V <sub>IH</sub>	2.1			V	VDD = 3.3 V ± 10%
Input Low Voltage, V <sub>IL</sub>			0.8	V	VDD = 5 V ± 5%
Input Low Voltage, V <sub>IL</sub>			0.4	V	VDD = 3.3 V ± 10%
Input Current			±100	nA	
Pin Capacitance		3	10	pF	
<b>LOGIC OUTPUTS (FOUT, CLKOUT)<sup>3</sup></b>					
Output High Voltage, V <sub>OH</sub>	4.0			V	Output Sourcing 200 µA <sup>6</sup> . VDD = 5 V ± 5%
Output High Voltage, V <sub>OH</sub>	2.1			V	Output Sourcing 200 µA <sup>6</sup> . VDD = 3.3 V ± 10%
Output Low Voltage, V <sub>OL</sub>		0.1	0.4	V	Output Sinking 1.6 mA <sup>6</sup>
<b>POWER REQUIREMENTS</b>					
V <sub>DD</sub> <sup>7</sup>	3.0		5.25	V	
I <sub>DD</sub> (Normal Mode) <sup>8</sup>		0.9	1.25	mA	V <sub>IH</sub> = VDD, V <sub>IL</sub> = GND. Unbuffered Mode
I <sub>DD</sub> (Normal Mode) <sup>8</sup>		1.1	1.5	mA	V <sub>IH</sub> = VDD, V <sub>IL</sub> = GND. Buffered Mode
I <sub>DD</sub> (Power-Down)		30	100	µA	
Power-Up Time <sup>3</sup>		30		µs	Exiting Power-Down (Ext. Clock at CLKIN)

## NOTES

<sup>1</sup>Temperature range: K Version, 0°C to +85°C; Y Version, -40°C to +105°C; typical specifications are at 25°C.

<sup>2</sup>See Terminology.

<sup>3</sup>Guaranteed by design and characterization, not production tested.

<sup>4</sup>Span = Max output frequency–Min output frequency.

<sup>5</sup>Because this pin is bidirectional, any external reference must be capable of sinking/sourcing 400 µA in order to overdrive the internal reference.

<sup>6</sup>These logic levels apply to CLKOUT only when it is loaded with one CMOS load.

<sup>7</sup>Operation at VDD = 2.7 V is also possible with degraded specifications.

<sup>8</sup>Outputs unloaded. I<sub>DD</sub> increases by C<sub>L</sub> × V<sub>OUT</sub> × f<sub>FOUT</sub> when FOUT is loaded. If using a crystal/resonator as the clock source, I<sub>DD</sub> will vary depending on the crystal/resonator type (see Clock Generation section).

Specifications subject to change without notice.

## TIMING CHARACTERISTICS<sup>1, 2, 3</sup> (VDD = 3.0 V to 3.6 V, 4.75 V to 5.25 V, GND = 0 V, REFIN = 2.5 V)

Parameter	Limit at T <sub>MIN</sub> , T <sub>MAX</sub> VDD = 3.0 V to 3.6 V	Limit at T <sub>MIN</sub> , T <sub>MAX</sub> VDD = 4.75 V to 5.25 V	Unit	Conditions/Comments
f <sub>CLKIN</sub>	32 1	32 1	kHz min MHz max	Clock Frequency
t <sub>HIGH</sub> :t <sub>LOW</sub>	40:60 60:40	40:60 60:40	min max	Clock Mark/Space Ratio
t <sub>1</sub>	50	35	ns typ	CLKIN Edge to FOUT Edge Delay
t <sub>2</sub>	2.3	1.8	ns typ	FOUT Rise Time
t <sub>3</sub>	1.6	1.4	ns typ	FOUT Fall Time
t <sub>4</sub>	t <sub>HIGH</sub> ± 20	t <sub>HIGH</sub> ± 8	ns typ	FOUT Pulsewidth

### NOTES

<sup>1</sup>Guaranteed by design and characterization, not production tested.

<sup>2</sup>All input signals are specified with tr = tf = 5 ns (10% to 90% of VDD) and timed from a voltage level of (V<sub>IL</sub> + V<sub>IH</sub>)/2.

<sup>3</sup>See Figure 1.

Specifications subject to change without notice.

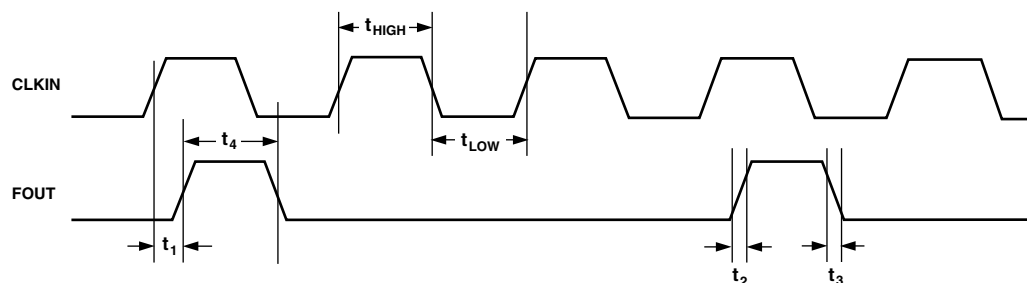

Figure 1. Timing Diagram

### ABSOLUTE MAXIMUM RATINGS\*

(T<sub>A</sub> = 25°C unless otherwise noted)

VDD to GND	-0.3 V to +7 V
Analog Input Voltage to GND	-0.3 V to V <sub>DD</sub> + 0.3 V
Reference Input Voltage to GND	-0.3 V to V <sub>DD</sub> + 0.3 V
Logic Input Voltage to GND	-0.3 V to V <sub>DD</sub> + 0.3 V
FOUT Voltage to GND	-0.3 V to V <sub>DD</sub> + 0.3 V
Operating Temperature Range	
Commercial (K Version)	0°C to +85°C
Automotive (Y Version)	-40°C to +105°C
Storage Temperature Range	-65°C to +150°C
Junction Temperature (T <sub>J</sub> Max)	150°C
SOT-23 Package	
Power Dissipation	(T <sub>J</sub> Max - T <sub>A</sub> )/θ <sub>JA</sub>
θ <sub>JA</sub> Thermal Impedance	240°C/W
Lead Temperature (10 secs)	300°C
Reflow Soldering	
Peak Temperature	220 + 5/0°C
Time at Peak Temperature	10 sec to 40 sec

### microSOIC Package

Power Dissipation	(T <sub>J</sub> Max - T <sub>A</sub> )/θ <sub>JA</sub>
θ <sub>JA</sub> Thermal Impedance	206°C/W
θ <sub>JC</sub> Thermal Impedance	44°C/W
Lead Temperature (10 secs)	300°C
Reflow Soldering	
Peak Temperature	220 + 5/0°C
Time at Peak Temperature	10 sec to 40 sec

\*Stresses above those listed under Absolute Maximum Ratings may cause permanent damage to the device. This is a stress rating only; functional operation of the device at these or any other conditions above those listed in the operational sections of this specification is not implied. Exposure to absolute maximum rating conditions for extended periods may affect device reliability.

### CAUTION

ESD (electrostatic discharge) sensitive device. Electrostatic charges as high as 4000 V readily accumulate on the human body and test equipment and can discharge without detection. Although the AD7740 features proprietary ESD protection circuitry, permanent damage may occur on devices subjected to high-energy electrostatic discharges. Therefore, proper ESD precautions are recommended to avoid performance degradation or loss of functionality.



# AD7740

## PIN CONFIGURATIONS

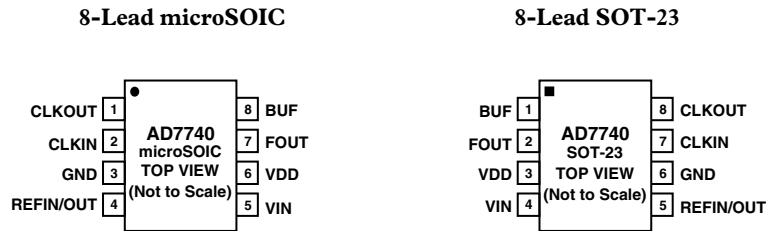

## PIN FUNCTION DESCRIPTIONS

### 8-LEAD microSOIC PIN NUMBERS\*

Pin No.	Mnemonic	Function
1	CLKOUT	The crystal/resonator is tied between this pin and CLKIN. In the case of an external clock driving CLKIN, an inverted clock signal appears on this pin and can be used to drive other circuitry provided it is buffered first.
2	CLKIN	The master clock for the device may be in the form of a crystal/resonator tied between this pin and CLKOUT. An external CMOS-compatible clock may also be applied to this input as the clock for the device. If CLKIN is inactive low for 1 ms (typ), the AD7740 automatically enters power-down.
3	GND	Ground reference for all the circuitry on-chip.
4	REFIN/OUT	Voltage Reference Input. This is the reference input to the core of the VFC and defines the span of the VFC. If this pin is left unconnected, the internal 2.5 V reference is the default reference. Alternatively, a precision external reference may be used to overdrive the internal reference. The internal reference has high output impedance in order to allow it to be overdriven.
5	VIN	The analog input to the VFC. It has a nominal input range from 0 V to $V_{REF}$ which corresponds to an output frequency of 10% $f_{CLKIN}$ to 90% $f_{CLKIN}$ . It has a $\pm 150$ mV overrange. If buffered, it draws virtually no current from whatever source is driving it.
6	VDD	Power Supply Input. These parts can be operated at $3.3\text{ V} \pm 10\%$ or $5\text{ V} \pm 5\%$ . The supply should be adequately decoupled with a $10\ \mu\text{F}$ and a $0.1\ \mu\text{F}$ capacitor to GND.
7	FOUT	Frequency Output. FOUT goes from 10% to 90% of $f_{CLKIN}$ , depending on VIN.
8	BUF	Buffered Mode Select Pin. When BUF is tied low, the VIN input is unbuffered and the range on the VIN pin is $-0.15\text{ V}$ to $VDD + 0.15\text{ V}$ . When it is tied high, VIN is buffered and the range on the VIN pin is restricted to $0.1\text{ V}$ to $VDD - 0.2\text{ V}$ .

\*Note that the SOT-23 and microSOIC packages have different pinouts.

## ORDERING GUIDE

Model	Temperature Range	Package Description	Package Option	Branding Information
AD7740KRM	0°C to 85°C	microSOIC Package	RM-8	VOK
AD7740YRT	-40°C to +105°C	SOT-23 Package	RT-8	VOY
AD7740YRM	-40°C to +105°C	microSOIC Package	RM-8	VOY

**TERMINOLOGY****INTEGRAL NONLINEARITY**

For the VFC, Integral Nonlinearity (INL) is a measure of the maximum deviation from a straight line passing through the actual endpoints of the VFC transfer function. The error is expressed in % of the actual frequency span:

$$\text{Frequency Span} = F_{OUT}(\text{max}) - F_{OUT}(\text{min})$$

**OFFSET ERROR**

Ideally, the output frequency for 0 V input voltage is 10% of  $f_{CLKIN}$  in unbuffered mode. The deviation from this value referred to the input is the offset error at  $BUF = 0$ . In buffered mode the minimum output frequency (corresponding to 0.10 V minimum input voltage) is 13.2% of  $f_{CLKIN}$  at  $V_{REF} = 2.5$  V. The deviation from this value referred to the input is the offset error at  $BUF = 1$ . Offset error is expressed in mV.

**GAIN ERROR**

This is a measure of the span error of the VFC. The gain is the scale factor that relates the input  $V_{IN}$  to the output  $F_{OUT}$ . The gain error is the deviation in slope of the actual VFC transfer characteristic from the ideal expressed as a percentage of the full-scale span. See Figure 2.

**OFFSET ERROR DRIFT**

This is a measure of the change in Offset Error with changes in temperature. It is expressed in  $\mu\text{V}/^\circ\text{C}$ .

**GAIN ERROR DRIFT**

This is a measure of the change in Gain Error with changes in temperature. It is expressed in (ppm of span)/ $^\circ\text{C}$ .

**POWER SUPPLY REJECTION RATIO (PSRR)**

This indicates how the apparent input voltage of the VFC is affected by changes in the supply voltage. The input voltage is kept constant at 2 V,  $V_{REF}$  is 2.5 V and the VDD supply is varied  $\pm 10\%$  at 3.3 V and  $\pm 5\%$  at 5 V. The ratio of the apparent change in input voltage to the change in VDD is measured in dBs.

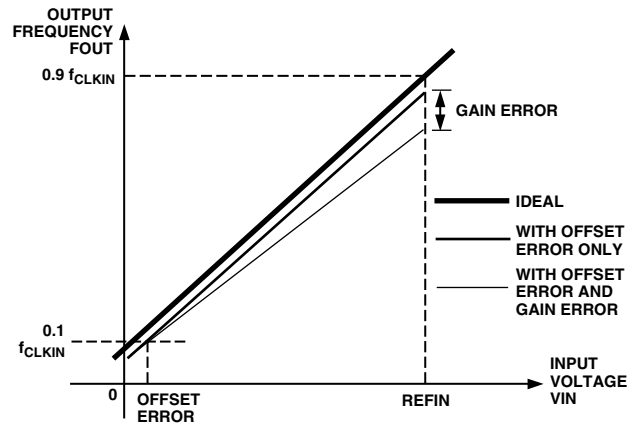
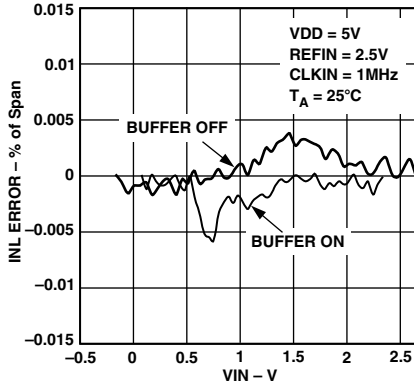
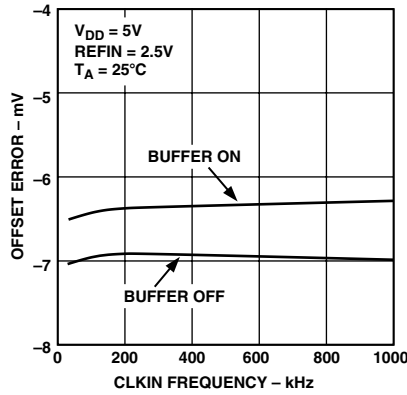

Figure 2. Offset and Gain

# AD7740—Typical Performance Characteristics



TPC 1. INL vs. VIN (Buffered and Unbuffered)



TPC 2. Offset Error vs. CLKIN (Buffered and Unbuffered)

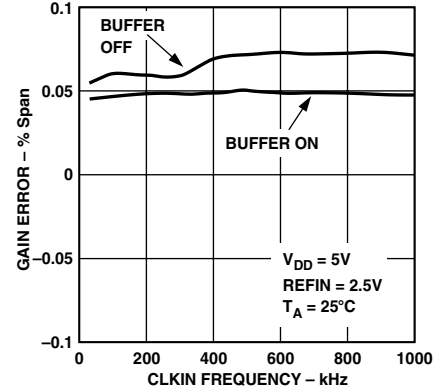

TPC 3. Gain Error vs. CLKIN (Buffered and Unbuffered)

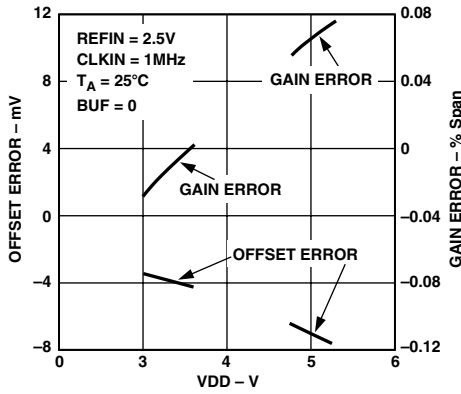

TPC 4. Offset and Gain Error vs. VDD

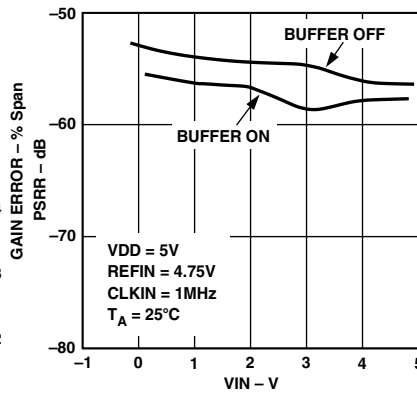

TPC 5. PSRR vs. VIN (Buffered and Unbuffered)

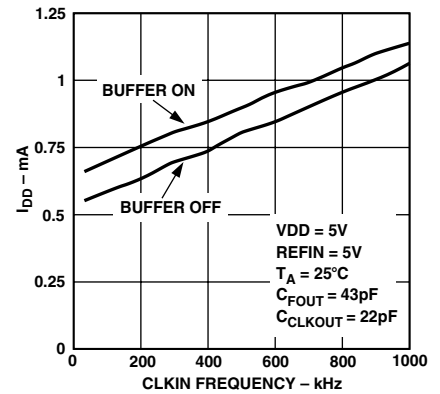

TPC 6.  $I_{DD}$  vs. CLKIN (Buffered and Unbuffered)

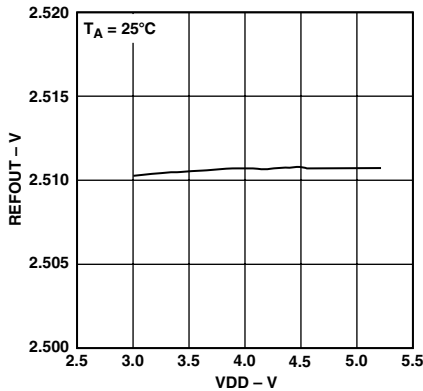

TPC 7. REFOUT vs. VDD

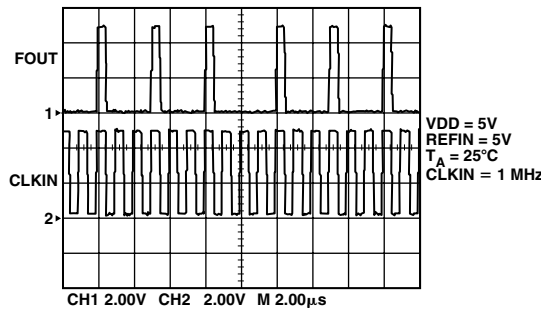

TPC 8. Typical FOUT Pulse Train ( $V_{IN} = V_{REF}/4$ )

## GENERAL DESCRIPTION

The AD7740 is a CMOS synchronous Voltage-to-Frequency Converter (VFC) which uses a charge-balance conversion technique. The input voltage signal is applied to a proprietary front-end based around an analog modulator which converts the input voltage into an output pulse train.

The part also contains an on-chip 2.5 V bandgap reference and operates from a single 3.3 V or 5 V supply. A block diagram of the AD7740 is shown in Figure 3.

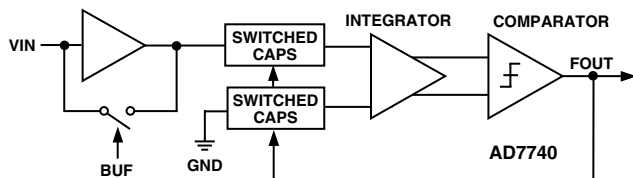

Figure 3. Block Diagram

### Input Amplifier Buffering and Voltage Range

The analog input  $V_{IN}$  can be buffered by setting  $BUF = 1$ . This presents a high impedance, typically 100 M $\Omega$ , which allows significant external source impedances to be tolerated. The  $V_{IN}$  voltage range is now 0.1 V to  $V_{DD} - 0.2$  V. By setting  $BUF = 0$  the AD7740 input circuit accepts an analog input below GND and the analog input  $V_{IN}$  has a voltage range from  $-0.15$  V to  $V_{DD} + 0.15$  V. In this case the input impedance is typically 650 k $\Omega$ .

The transfer function for the AD7740 is represented by:

$$F_{OUT} = 0.1 f_{CLKIN} + 0.8 (V_{IN}/V_{REF}) f_{CLKIN}$$

It is shown in Figure 4 for unbuffered mode.

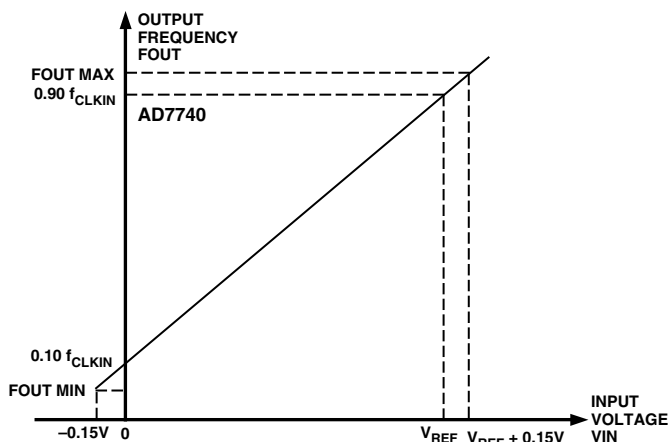

Figure 4. Transfer Function

### Sample Calculation:

$V_{REF} = 2.5$  V,  $BUF = 0$

$$\begin{aligned} F_{OUT}(\text{min}) &= 0.1 f_{CLKIN} + 0.8(-0.15/2.5) f_{CLKIN} \\ &= 0.052 f_{CLKIN} \end{aligned}$$

$$\begin{aligned} F_{OUT}(\text{max}) &= 0.1 f_{CLKIN} + 0.8(2.65/2.5) f_{CLKIN} \\ &= 0.948 f_{CLKIN} \end{aligned}$$

## VFC Modulator

The analog input signal to the AD7740 is continuously sampled by a switched capacitor modulator whose sampling rate is set by a master clock. The input signal may be buffered on-chip ( $BUF = 1$ ) before being applied to the sampling capacitor of the modulator. This isolates the sampling capacitor charging currents from the analog input pin.

This system is a negative feedback loop that acts to keep the net charge on the integrator capacitor at zero, by balancing charge injected by the input voltage with charge injected by  $V_{REF}$ . The output of the comparator provides the digital input for the 1-bit DAC, so that the system functions as a negative feedback loop that acts to minimize the difference signal. See Figure 5.

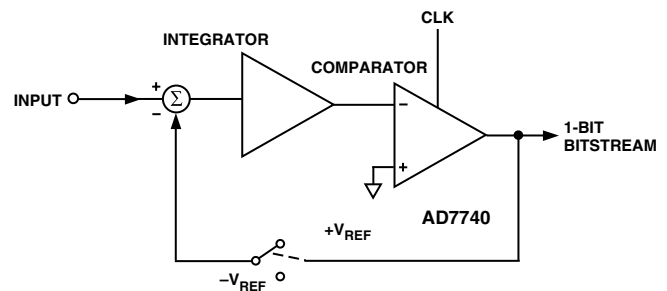

Figure 5. Modulator Loop

The digital data that represents the analog input voltage is contained in the duty cycle of the pulse train appearing at the output of the comparator. The output is a pulse train whose frequency depends on the analog input signal. A full-scale input gives an output frequency of  $0.9 f_{CLKIN}$  and zero-scale input gives an output frequency of  $0.1 f_{CLKIN}$ . The output allows simple interfacing to either standard logic families or opto-couplers. The pulsewidth of  $F_{OUT}$  is fixed and is determined by the high period of  $CLKIN$ . The pulse is synchronized to the rising edge of the clock signal. The delay time between the edge of  $CLKIN$  and the edge of  $F_{OUT}$  is typically 35 ns. Figure 6 shows the waveform of this frequency output. (See TPC 8.)

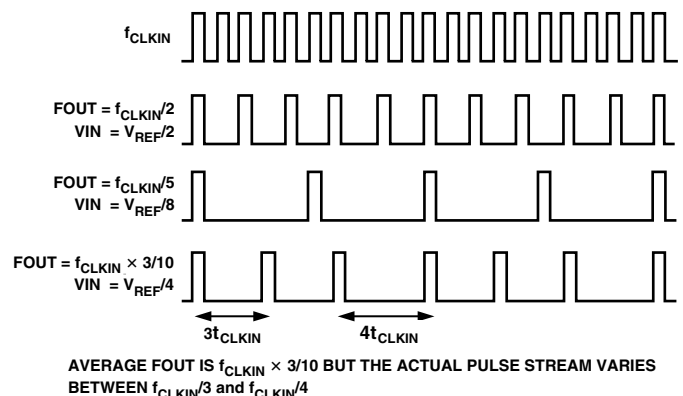

Figure 6. Frequency Output Waveforms

If there is a step change in input voltage, there is a settling time that must elapse before valid data is obtained. This is typically two  $CLKIN$  cycles.





## A/D Conversion Techniques Using the AD7740

One method of using a VFC in an A/D system is to count the output pulses of FOUT for a fixed gate interval (see Figure 9). This fixed gate interval should be generated by dividing down the clock input frequency. This ensures that any errors due to clock jitter or clock frequency drift are eliminated. The ratio of the FOUT frequency to the clock frequency is what is important here, not the absolute value of FOUT. The frequency division can be done by a binary counter where CLKIN is the counter input.

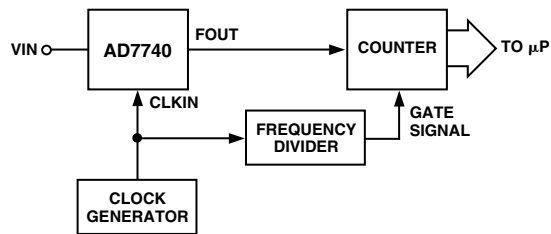

Figure 9. A/D Conversion Using the AD7740 VFC

Figure 10 shows the waveforms of CLKIN, FOUT, and the Gate signal. A counter counts the rising edges of FOUT while the Gate signal is high. Since the gate interval is not synchronized with FOUT, there is a possibility of a counting inaccuracy. Depending on FOUT, an error of one count may occur.

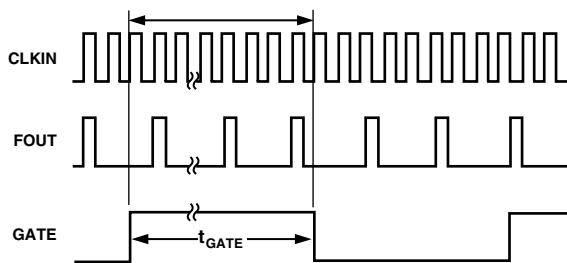

Figure 10. Waveforms in an A/D Converter Using a VFC

The clock frequency and the gate time determine the resolution of such an ADC. If 12-bit resolution is required and CLKIN is 1 MHz (therefore, FOUT<sub>MAX</sub> is 0.9 MHz), the minimum gate time required is calculated as follows:

N counts at Full Scale (0.9 MHz) will take

$$(N/0.9 \times 10^6) \text{ seconds} = \text{minimum gate time}$$

N is the total number of codes for a given resolution; 4096 for 12 bits.

$$\text{minimum gate time} = (4096/0.9 \times 10^6) \text{ seconds} = 4.551 \text{ ms}$$

Since  $T_{\text{GATE}} \times \text{FOUT}_{\text{MAX}} = \text{number of counts at full scale}$ , the fastest conversion for a given resolution can be performed with the highest CLKIN frequency.

If the output frequency is measured by counting pulses gated to a signal derived from the clock, the clock stability is unimportant and the device simply performs as a voltage-controlled frequency divider, producing a high-resolution ADC. The inherent monotonicity of the transfer function and wide range of input clock frequencies allows the conversion time and resolution to be optimized for specific applications.

Another parameter is taken into account when choosing the length of the gate interval. Because the integration period of the VFC is equal to the gate interval, any interfering signal can be rejected by counting for an integer number of periods of the interfering signal. For example, a gate interval of 100 ms will give normal-mode rejection of 50 Hz and 60 Hz signals.

## Isolation Applications

The AD7740 can also be used in isolated analog signal transmission applications. Due to noise, safety requirements or distance, it may be necessary to isolate the AD7740 from any controlling circuitry. This can easily be achieved by using opto-isolators. This is extremely useful in overcoming ground loops between equipment.

The analog voltage to be transmitted is converted to a pulse train using the VFC. An opto-isolator circuit is used to couple this pulse train across an isolation barrier using light as the connecting medium. The input LED of the isolator is driven from the output of the AD7740. At the receiver side, the output transistor is operated in the photo-transistor mode. The pulse train can be reconverted to an analog voltage using a frequency-to-voltage converter; alternatively, the pulse train can be fed into a counter to generate a digital signal.

The analog and digital sections of the AD7740 have been designed to allow operation from a single-ended power source, simplifying its use with isolated power supplies.

Figure 11 shows a general purpose VFC circuit using a low cost opto-isolator. A 5 V power supply is assumed for both the isolated ( $V_{\text{DD}}$ ) and local ( $V_{\text{CC}}$ ) supplies.

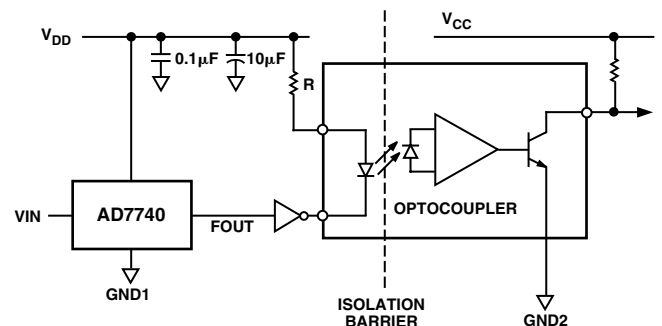

Figure 11. Opto-Isolated Application

# AD7740

## Temperature Sensor Application

The AD7740 can be used with an AD22100S temperature sensor to give a digital measure of ambient temperature. The output voltage of the AD22100S is proportional to the temperature times the supply voltage. It uses a single 5 V supply, and its output swings from 0.25 V at  $-50^{\circ}\text{C}$  to 4.75 V at  $+150^{\circ}\text{C}$ . By feeding its output through the AD7740, the value of ambient temperature is converted into a digital pulse train. See Figure 12.

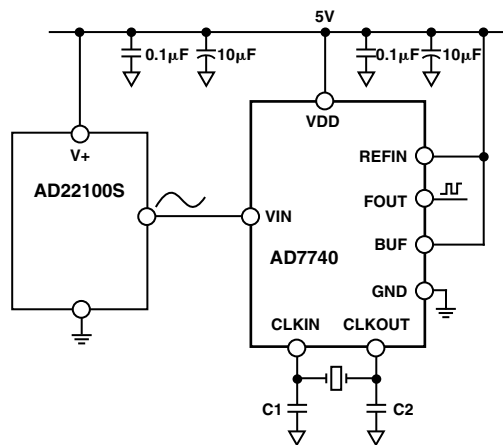

Figure 12. Using the AD7740 with a Temperature Sensor

Due to its ratiometric nature this application provides an extremely cost-effective solution. The need for an external precision reference is eliminated since the 5 V power-supply is used as a reference to both the VFC and the AD22100S.

## 32 kHz Operation

The AD7740 oscillator circuit will not operate at 32 kHz. If the user wishes to use a 32 kHz watch crystal, some additional external circuitry is required. The circuit in Figure 13 is for a crystal with a required drive of  $1\ \mu\text{W}$ . Resistors R1 and R2 reduce the power to this level.

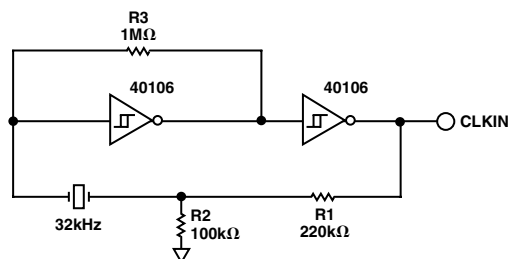

Figure 13. 32 kHz Watch Crystal Circuit

## Power Supply Bypassing and Grounding

In any circuit where accuracy is important, careful consideration of the power supply and ground return layout helps to ensure the rated performance. The printed circuit board housing the AD7740 should be designed such that the analog and digital sections are separated and confined to certain areas of the board.

To minimize capacitive coupling between them, digital and analog ground planes should only be joined in one place, close to the AD7740, and should not overlap.

Avoid running digital lines under the device, as these will couple noise onto the die. The analog ground plane should be allowed to run under the AD7740 to avoid noise coupling. The power supply lines to the AD7740 should use as large a trace as possible to provide low impedance paths and reduce the effects of glitches on the power supply line. Fast switching signals like clocks should be shielded with digital ground to avoid radiating noise to other parts of the board, and clock signals should never be run near analog inputs. Avoid crossover of digital and analog signals. Traces on opposite sides of the board should run at right angles to each other. This reduces the effect of feedthrough through the board. A microstrip technique is by far the best but is not always possible with a double-sided board. In this technique, the component side of the board is dedicated to the ground plane while the signal traces are placed on the solder side.

Good decoupling is also important. All analog supplies should be decoupled to GND with surface mount capacitors,  $10\ \mu\text{F}$  in parallel with  $0.1\ \mu\text{F}$  located as close to the package as possible, ideally right up against the device. The lead lengths on the bypass capacitor should be as short as possible. It is essential that these capacitors be placed physically close to the AD7740 to minimize the inductance of the PCB trace between the capacitor and the supply pin. The  $10\ \mu\text{F}$  are the tantalum bead type and are located in the vicinity of the VFC to reduce low-frequency ripple. The  $0.1\ \mu\text{F}$  capacitors should have low Effective Series Resistance (ESR) and Effective Series Inductance (ESI), such as the common ceramic types, which provide a low impedance path to ground at high frequencies to handle transient currents due to internal logic switching. Additionally, it is beneficial to have large capacitors ( $> 47\ \mu\text{F}$ ) located at the point where the power connects to the PCB.

**OUTLINE DIMENSIONS**

Dimensions shown in inches and (mm).

**8-Lead microSOIC  
(RM-8)**

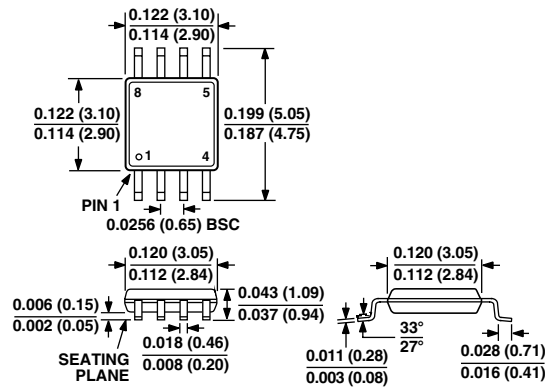

**8-Lead SOT-23  
(RT-8)**

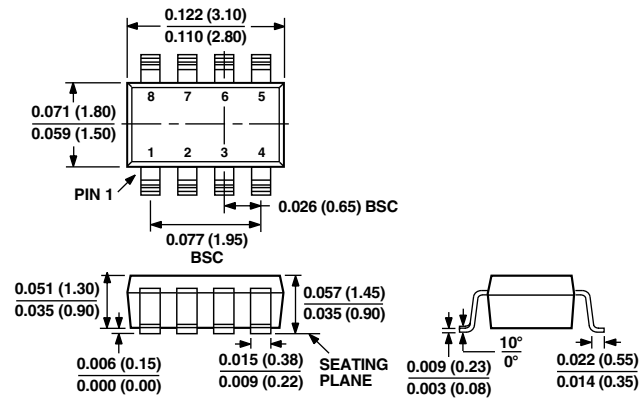

Компания «Океан Электроники» предлагает заключение долгосрочных отношений при поставках импортных электронных компонентов на взаимовыгодных условиях!

Наши преимущества:

- Поставка оригинальных импортных электронных компонентов напрямую с производств Америки, Европы и Азии, а так же с крупнейших складов мира;
- Широкая линейка поставок активных и пассивных импортных электронных компонентов (более 30 млн. наименований);
- Поставка сложных, дефицитных, либо снятых с производства позиций;
- Оперативные сроки поставки под заказ (от 5 рабочих дней);
- Экспресс доставка в любую точку России;
- Помощь Конструкторского Отдела и консультации квалифицированных инженеров;
- Техническая поддержка проекта, помощь в подборе аналогов, поставка прототипов;
- Поставка электронных компонентов под контролем ВП;
- Система менеджмента качества сертифицирована по Международному стандарту ISO 9001;
- При необходимости вся продукция военного и аэрокосмического назначения проходит испытания и сертификацию в лаборатории (по согласованию с заказчиком);
- Поставка специализированных компонентов военного и аэрокосмического уровня качества (Xilinx, Altera, Analog Devices, Intersil, Interpoint, Microsemi, Actel, Aeroflex, Peregrine, VPT, Syfer, Eurofarad, Texas Instruments, MS Kennedy, Miteq, Cobham, E2V, MA-COM, Hittite, Mini-Circuits, General Dynamics и др.);

Компания «Океан Электроники» является официальным дистрибьютором и эксклюзивным представителем в России одного из крупнейших производителей разъемов военного и аэрокосмического назначения «JONHON», а так же официальным дистрибьютором и эксклюзивным представителем в России производителя высокотехнологичных и надежных решений для передачи СВЧ сигналов «FORSTAR».



## JONHON

«JONHON» (основан в 1970 г.)

Разъемы специального, военного и аэрокосмического назначения:

(Применяются в военной, авиационной, аэрокосмической, морской, железнодорожной, горно- и нефтедобывающей отраслях промышленности)

«FORSTAR» (основан в 1998 г.)

ВЧ соединители, коаксиальные кабели,  
кабельные сборки и микроволновые компоненты:

(Применяются в телекоммуникациях гражданского и специального назначения, в средствах связи, РЛС, а так же военной, авиационной и аэрокосмической отраслях промышленности).



Телефон: 8 (812) 309-75-97 (многоканальный)

Факс: 8 (812) 320-03-32

Электронная почта: [ocean@oceanchips.ru](mailto:ocean@oceanchips.ru)

Web: <http://oceanchips.ru/>

Адрес: 198099, г. Санкт-Петербург, ул. Калинина, д. 2, корп. 4, лит. А