

PLC-RPIT-230UC/ 1AU/SEN

Order No.: 2900315



<http://eshop.phoenixcontact.de/phoenix/treeViewClick.do?UID=2900315>

PLC sensor relay, consisting of PLC-BPIT...SEN basic terminal block with Push-In connection and pluggable miniature relay with multi-layer contact, for assembly on DIN rail NS 35/7.5, 1 N/O contact, input voltage 230 V AC / 220 V DC



Commercial data	
GTIN (EAN)	4 046356 507387
sales group	G226
Pack	10 pcs.
Customs tariff	85364190
Catalog page information	Page 90 (IF-2011)

Product notes

WEEE/RoHS-compliant since:
04/08/2009



<http://www.download.phoenixcontact.com>
Please note that the data given here has been taken from the online catalog. For comprehensive information and data, please refer to the user documentation. The General Terms and Conditions of Use apply to Internet downloads.

Technical data	
Coil side	
Nominal input voltage U_N	230 V AC (220 V DC)
	220 V DC
Nominal input current at U_{IN}	3.2 mA

Typical response time	7 ms
Typical release time	15 ms
Operating voltage display	Yellow LED
Protective circuit	Bridge rectifier Bridge rectifier

Contact side

Contact type	Single contact, 1 N/O contact
Contact material	AgSnO, hard gold-plated
Maximum switching voltage	30 V AC 36 V DC
Minimum switching voltage	100 mV (at 10 mA)
Maximum inrush current	50 mA
Min. switching current	1 mA (at 24 V)
Limiting continuous current	50 mA
Interrupting rating (ohmic load) max.	1 W (at 24 V DC)
Note	the following values are applicable if a gold layer is destroyed
Maximum switching voltage	250 V AC/DC
Minimum switching voltage	5 V (at 100 mA)
Limiting continuous current	6 A
Min. switching current	10 mA (at 12 V)
Interrupting rating (ohmic load) max.	140 W (at 24 V DC) 20 W (for 48 V DC) 18 W (for 60 V DC) 23 W (for 110 V DC) 40 W (for 220 V DC) 1500 VA (for 250 V AC)

General data

Width	6.2 mm
Height	80 mm
Depth	94 mm
Test voltage relay winding/relay contact	4 kV AC (50 Hz, 1 min.)
Ambient temperature (operation)	-40 °C ... 60 °C
Ambient temperature (storage/transport)	-40 °C ... 85 °C
Operating mode	100% operating factor
Mechanical service life	2 x 10 ⁷ cycles

Inflammability class acc. to UL 94	V0
Name	Standards/regulations
Standards/regulations	IEC 60664
	IEC 60664 A
	DIN VDE 0110
	DIN EN 50178/DIN VDE 0160 (in relevant parts)
	DIN EN 50178/VDE 0160
	IEC 60255/DIN VDE 0435 (in relevant parts)
Pollution degree	3
Surge voltage category	III
Mounting position	Any
Assembly instructions	In rows with zero spacing

Connection data

Connection method	Push-In connection
Conductor cross section solid min.	0.14 mm ²
Conductor cross section solid max.	2.5 mm ²
Conductor cross section stranded min.	0.14 mm ²
Conductor cross section stranded max.	2.5 mm ²
Conductor cross section AWG/kcmil min.	26
Conductor cross section AWG/kcmil max	14
Stripping length	8 mm

Certificates / Approvals



Certification

CUL, CUL Listed, UL, UL Listed

Accessories

Item	Designation	Description
Assembly		
0801762	NS 35/ 7,5 CU UNPERF 2000MM	DIN rail, material: Copper, unperforated, height 7.5 mm, width 35 mm, length: 2 m

0801733	NS 35/ 7,5 PERF 2000MM	DIN rail, material: steel galvanized and passivated with a thick layer, perforated, height 7.5 mm, width 35 mm, length: 2000 mm
0801681	NS 35/ 7,5 UNPERF 2000MM	DIN rail, material: Steel, unperforated, height 7.5 mm, width 35 mm, length: 2 m
0801377	NS 35/ 7,5 V2A UNPERF 2000MM	DIN rail, Width: 35 mm, Height: 7.5 mm, Length: 2000 mm, Color: silver
1201756	NS 35/15 AL UNPERF 2000MM	DIN rail, deep drawn, high profile, unperforated, 1.5 mm thick, material: aluminum, height 15 mm, width 35 mm, length 2000 mm
1201895	NS 35/15 CU UNPERF 2000MM	DIN rail, material: Copper, unperforated, 1.5 mm thick, height 15 mm, width 35 mm, length: 2 m
1201730	NS 35/15 PERF 2000MM	DIN rail, material: steel galvanized and passivated with a thick layer, perforated, height 15 mm, width 35 mm, length: 2000 mm
1201714	NS 35/15 UNPERF 2000MM	DIN rail, material: Steel, unperforated, height 15 mm, width 35 mm, length: 2 m
1201798	NS 35/15-2,3 UNPERF 2000MM	DIN rail, material: Steel, unperforated, 2.3 mm thick, height 15 mm, width 35 mm, length: 2 m
2966841	PLC-ATP BK	Separating plate, 2 mm thick, required at the start and end of a PLC terminal strip. Furthermore, it is used for: visual separation of groups, safe isolation of different voltages of neighboring PLC relays in acc. with DIN VDE 0106-101, isolation

Bridges

2966812	FBST 6-PLC BU	Single plug-in bridge, Length: 6 mm, Number of positions: 2, Color: blue
2966825	FBST 6-PLC GY	Single plug-in bridge, Length: 6 mm, Number of positions: 2, Color: gray
2966236	FBST 6-PLC RD	Single plug-in bridge, Length: 6 mm, Number of positions: 2, Color: red
2967688	FBST 8-PLC GY	Single plug-in bridge, Length: 8 mm, Number of positions: 2, Color: gray
2966692	FBST 500-PLC BU	Continuous plug-in bridge, Length: 500 mm, Color: blue
2966838	FBST 500-PLC GY	Continuous plug-in bridge, Length: 500 mm, Color: gray
2966786	FBST 500-PLC RD	Continuous plug-in bridge, Length: 500 mm, Color: red

General

2900452	PLC-BPIT-230UC/ 1/SEN	6.2 mm PLC sensor basic terminal blocks with Push-In connection method, input voltage of 230 V AC (without relay or optocoupler)
2966508	PLC-ESK GY	Power terminal block, for the input of up to four potentials, for mounting on NS 35/7.5
2296087	PLC-V8/D15B/IN	V8-INPUT adapter for eight 6.2 mm PLC interfaces (1 PDT, etc./ see "Additional Products"). 15-pin D-SUB female connector, control logic: Positive switching

2296074	PLC-V8/D15S/IN	V8-INPUT adapter for eight 6.2 mm PLC interfaces (1 PDT, etc./ see "Additional Products"). 15-pin D-SUB male connector, control logic: Positive switching
2296553	PLC-V8/FLK14/IN	V8L-INPUT adapter for eight 6.2 mm PLC interfaces (1 PDT, etc./see "Supplementary Products"). 14-pos. flat-ribbon cable connection for the PLC system cabling, control logic: Plus switching
2304115	PLC-V8/FLK14/IN/M	V8L-INPUT adapter for eight 6.2 mm PLC interfaces (1 PDT, etc./see "Supplementary Products"). 14-pos. flat-ribbon cable connection for the PLC system cabling, control logic: Minus switching
2961134	REL-MR- 60DC/21AU	Pluggable miniature relays, with multi-layer contact, 1 PDT, input voltage 60 V DC

Marking

1051016	ZB 6,LGS:FORTL.ZAHLEN	Zack marker strip, 10-section, printed horizontally: with the numbers 1 - 10, 11 - 20 and so on up to 491 - 500, color: white
5060935	ZB 6/WH-100:UNBEDRUCKT	Zack strip, unprinted: For individual labeling with M-PEN, ZB-T or CMS system, large batch, sufficient for labeling 1000 terminal blocks, for a terminal width of 6.2 mm, color: White
1051003	ZB 6:UNBEDRUCKT	Zack strip, unprinted, strips with 10 labels for individual labeling with M-PEN or CMS system, for terminal block width: 6.2 mm, color: white

Tools

1204517	SZF 1-0,6X3,5	Actuation tool, for ST terminal blocks, also suitable for use as a bladed screwdriver, size: 0.6 x 3.5 x 100 mm, 2-component grip, with non-slip grip
---------	---------------	---

Diagrams/Drawings

Diagram

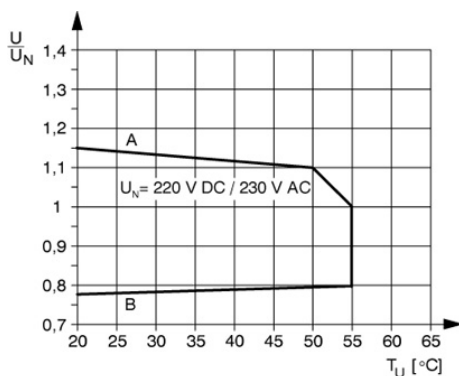

Circuit diagram

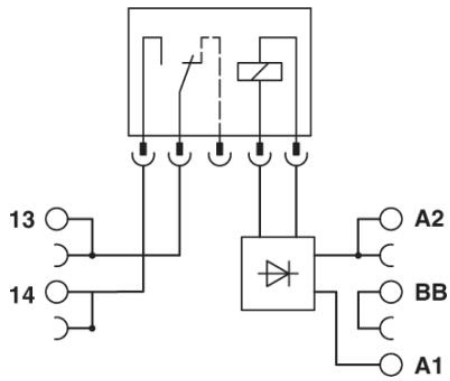

Address

PHOENIX CONTACT Inc., USA
586 Fulling Mill Road
Middletown, PA 17057, USA
Phone (800) 888-7388
Fax (717) 944-1625
<http://www.phoenixcon.com>



© 2011 Phoenix Contact
Technical modifications reserved;

Компания «Океан Электроники» предлагает заключение долгосрочных отношений при поставках импортных электронных компонентов на взаимовыгодных условиях!

Наши преимущества:

- Поставка оригинальных импортных электронных компонентов напрямую с производств Америки, Европы и Азии, а так же с крупнейших складов мира;
- Широкая линейка поставок активных и пассивных импортных электронных компонентов (более 30 млн. наименований);
- Поставка сложных, дефицитных, либо снятых с производства позиций;
- Оперативные сроки поставки под заказ (от 5 рабочих дней);
- Экспресс доставка в любую точку России;
- Помощь Конструкторского Отдела и консультации квалифицированных инженеров;
- Техническая поддержка проекта, помощь в подборе аналогов, поставка прототипов;
- Поставка электронных компонентов под контролем ВП;
- Система менеджмента качества сертифицирована по Международному стандарту ISO 9001;
- При необходимости вся продукция военного и аэрокосмического назначения проходит испытания и сертификацию в лаборатории (по согласованию с заказчиком);
- Поставка специализированных компонентов военного и аэрокосмического уровня качества (Xilinx, Altera, Analog Devices, Intersil, Interpoint, Microsemi, Actel, Aeroflex, Peregrine, VPT, Syfer, Eurofarad, Texas Instruments, MS Kennedy, Miteq, Cobham, E2V, MA-COM, Hittite, Mini-Circuits, General Dynamics и др.);

Компания «Океан Электроники» является официальным дистрибьютором и эксклюзивным представителем в России одного из крупнейших производителей разъемов военного и аэрокосмического назначения «JONHON», а так же официальным дистрибьютором и эксклюзивным представителем в России производителя высокотехнологичных и надежных решений для передачи СВЧ сигналов «FORSTAR».



JONHON

«JONHON» (основан в 1970 г.)

Разъемы специального, военного и аэрокосмического назначения:

(Применяются в военной, авиационной, аэрокосмической, морской, железнодорожной, горно- и нефтедобывающей отраслях промышленности)

«FORSTAR» (основан в 1998 г.)

ВЧ соединители, коаксиальные кабели,
кабельные сборки и микроволновые компоненты:

(Применяются в телекоммуникациях гражданского и специального назначения, в средствах связи, РЛС, а так же военной, авиационной и аэрокосмической отраслях промышленности).



Телефон: 8 (812) 309-75-97 (многоканальный)

Факс: 8 (812) 320-03-32

Электронная почта: ocean@oceanchips.ru

Web: <http://oceanchips.ru/>

Адрес: 198099, г. Санкт-Петербург, ул. Калинина, д. 2, корп. 4, лит. А